

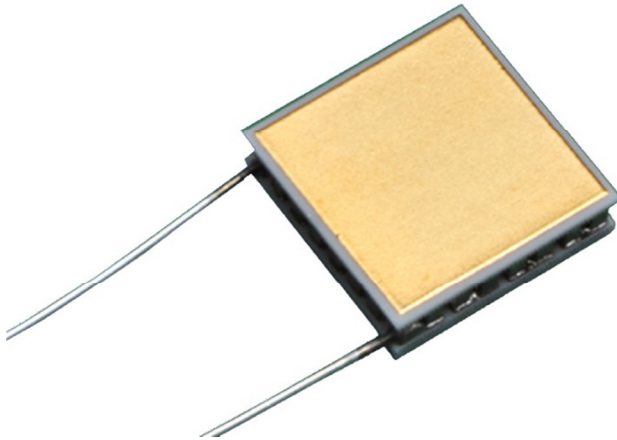

Technical Data Sheet for NL1020T

Single-Stage Thermoelectric Module



NOMINAL PERFORMANCE IN NITROGEN

Hot Side Temperature (°C)	27	50
ΔT_{max} (°C):	64	72
Q _{max} (watts):	0.9	1.0
I _{max} (amps):	1.8	1.8
V _{max} (vdc):	0.8	0.9
AC Resistance (ohms):	0.40	--

PRODUCT FEATURES

- RoHS EU Compliant
- REACH EU Compliant
- Rated operating temperature of 85°C.
- Maximum process temperature is 120°C.
- Ceramic Material: Aluminum Oxide
- -01AC, -02AC: External Metallization is Au flash, suitable for soldering.
- RTV sealing option available.

ORDERING OPTIONS

Model Number	Description
NL1020T-01AC	Both surfaces are metallized
NL1020T-02AC	Hot side exterior is metallized
NL1020T-03AC	No metallization
NL1020T-04AC	No metallization, Insulated Leads, Perimeter Sealed
NL1020T-05AC	No metallization, Insulated Leads

OPERATION CAUTIONS

For maximum reliability, storage and operation below 85°C in a non-condensing environment is recommended. To minimize thermal stress, use linear/proportional temperature control or a similar method rather than an ON/OFF method.

INSTALLATION

Recommended mounting methods: Bonding with thermal epoxy or soldering with metallized ceramics. For additional information, please refer to our TEC Installation Guide.

II-VI Marlow – Dallas, TX USA
214-340-4900
877-627-5691
marlow.sales@ii-vi.com

Marlow Industries Europe
GmbH - Germany
+49 (0) 6150 5439 - 403
info@marlow-europe.eu

II-VI Japan Inc.
81 43 297 2693 (tel)
center@ii-vi.co.jp
www.ii-vi.co.jp

II-VI Singapore Pte., Ltd.
(65) 6481 8215 (tel)
info@ii-vi.com.sg

Marlow Industries China, II-VI
Technologies Beijing
86-10-643 98226
info@iivibj.com





TYPICAL PERFORMANCE CURVES

ENVIRONMENT: ONE ATMOSPHERE DRY NITROGEN

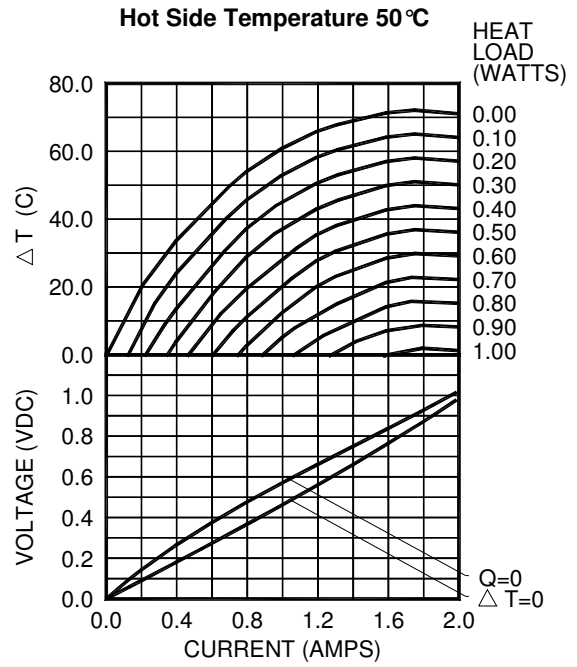
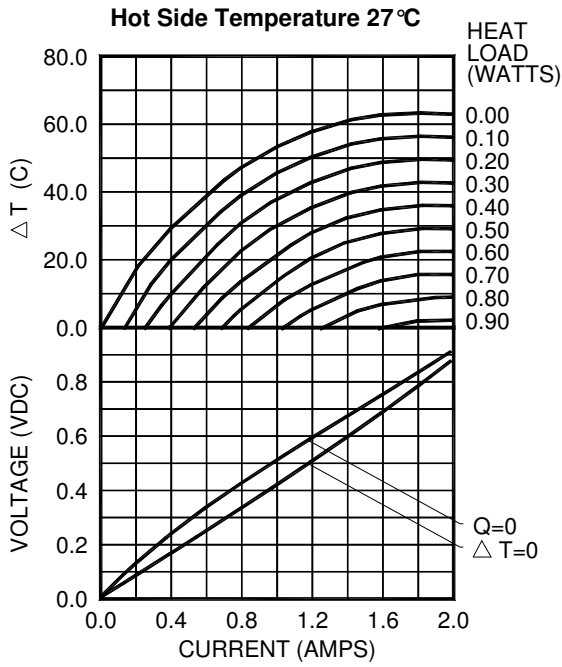

For performance information in a vacuum or with hot side temperatures other than 27°C or 50°C, contact one of our Applications Engineers at 877-627-5691.

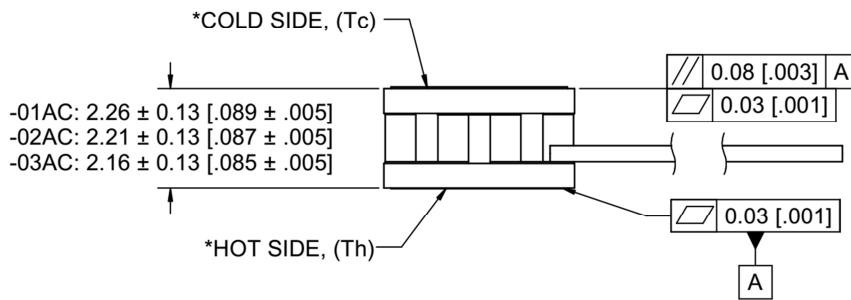
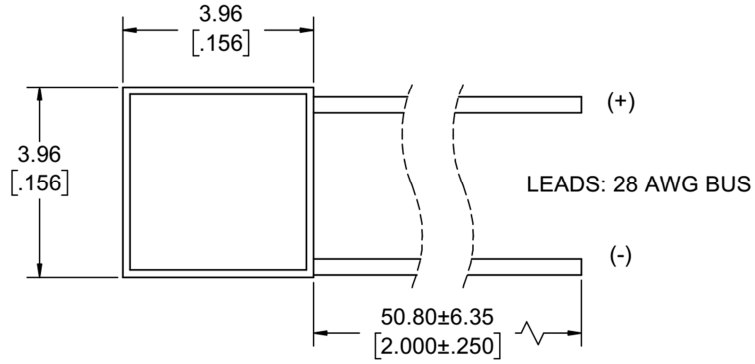

Dimensions are in millimeters, inches are in [].

* -01AC, -02AC Only: External Metallization per page 1.

-01AC, -02AC, -03AC

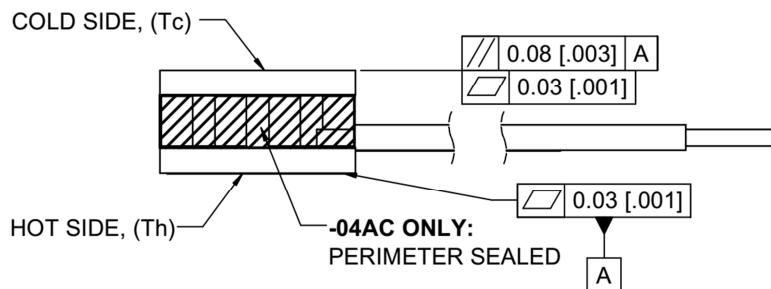
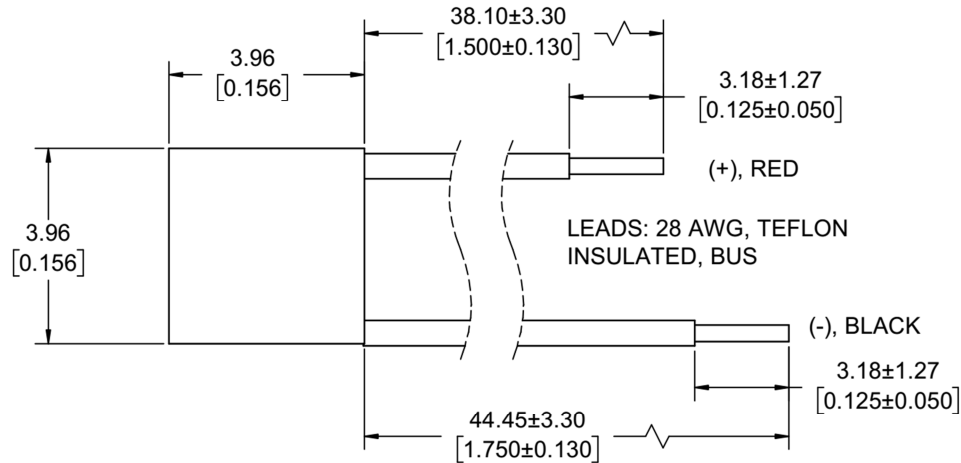

Dimensions are in millimeters, and inches are in [].

-04AC, -05AC

For customer support or general questions please contact a local office or visit our website at www.marlow.com.
Marlow reserves the right to make product changes without notice.