

STEALTH™ Dual Diode 60 A, 600 V

ISL9K3060G3

Description

The ISL9K3060G3 is a STEALTH dual diode optimized for low loss performance in high frequency hard switched applications. The STEALTH family exhibits low reverse recovery current (I_{RR}) and exceptionally soft recovery under typical operating conditions.

This device is intended for use as a free wheeling or boost diode in power supplies and other power switching applications. The low I_{RR} and short ta phase reduce loss in switching transistors. The soft recovery minimizes ringing, expanding the range of conditions under which the diode may be operated without the use of additional snubber circuitry. Consider using the STEALTH diode with an SMPS IGBT to provide the most efficient and highest power density design at lower cost.

Features

- Stealth Recovery $t_{rr} = 36$ ns (@ $I_F = 30$ A)
- Max Forward Voltage, $V_F = 2.4$ V (@ $T_C = 25^\circ\text{C}$)
- 600 V Reverse Voltage and High Reliability
- Avalanche Energy Rated
- This Device is Pb-Free and is RoHS Compliant

Applications

- Switch Mode Power Supplies
- Hard Switched PFC Boost Diode
- UPS Free Wheeling Diode
- Motor Drive FWD
- SMPS FWD
- Snubber Diode



ON Semiconductor®

www.onsemi.com

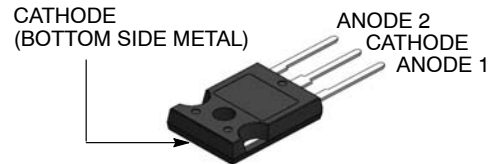

TO-247-3LD
CASE 340CK

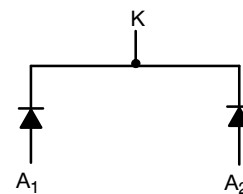

MARKING DIAGRAM

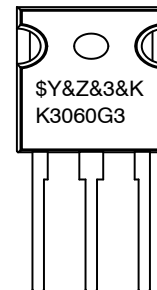

\$Y	= ON Semiconductor Logo
&Z	= Assembly Plant Code
&3	= Numeric Date Code
&K	= Lot Code
K3060G3	= Specific Device Code

ORDERING INFORMATION

See detailed ordering and shipping information on page 2 of this data sheet.

ISL9K3060G3

DEVICE MAXIMUM RATINGS (per leg) ($T_C = 25^\circ\text{C}$ unless otherwise noted)

Parameter	Symbol	Ratings	Unit
Repetitive Peak Reverse Voltage	V_{RRM}	600	V
Working Peak Reverse Voltage	V_{RWM}	600	V
DC Blocking Voltage	V_R	600	V
Average Rectified Forward Current ($T_C = 125^\circ\text{C}$)	$I_{F(AV)}$	30	A
Total Device Current (Both Legs)		60	A
Repetitive Peak Surge Current (20 kHz Square Wave)	I_{FRM}	70	A
Nonrepetitive Peak Surge Current (Halfwave 1 Phase 60 Hz)	I_{FSM}	325	A
Power Dissipation	P_D	200	W
Avalanche Energy (1 A, 40 mH)	E_{AVL}	20	mJ
Operating and Storage Temperature Range	T_J, T_{STG}	-55 to +175	$^\circ\text{C}$
Maximum Temperature for Soldering Leads at 0.063 in (1.6 mm) from Case for 10 s Package Body for 10 s, See Techbrief TB334	T_L	300	$^\circ\text{C}$
	T_{PKG}	260	$^\circ\text{C}$

Stresses exceeding those listed in the Maximum Ratings table may damage the device. If any of these limits are exceeded, device functionality should not be assumed, damage may occur and reliability may be affected.

PACKAGE MARKING AND ORDERING INFORMATION

Device	Device Marking	Package	Packing Method	Tape Width	Quantity
ISL9K3060G3	K3060G3	TO-247-3L	Tube	N/A	30

THERMAL CHARACTERISTICS

Parameter	Symbol	Test Conditions	Min	Typ	Max	Unit
Thermal Resistance Junction to Case	$R_{\theta JC}$		-	-	1.0	$^\circ\text{C}/\text{W}$
Thermal Resistance Junction to Ambient	$R_{\theta JA}$	TO-247	-	-	30	$^\circ\text{C}/\text{W}$

ISL9K3060G3

ELECTRICAL CHARACTERISTICS (per leg) ($T_C = 25^\circ\text{C}$ unless otherwise noted)

Parameter	Symbol	Test Conditions	Min	Typ	Max	Unit
-----------	--------	-----------------	-----	-----	-----	------

OFF STATE CHARACTERISTICS

Instantaneous Reverse Current	I_R	$V_R = 600\text{ V}$	$T_C = 25^\circ\text{C}$	-	-	100	μA
			$T_C = 125^\circ\text{C}$	-	-	1.0	mA

ON STATE CHARACTERISTICS

Instantaneous Forward Voltage	V_F	$I_F = 30\text{ A}$	$T_C = 25^\circ\text{C}$	-	2.1	2.4	V
			$T_C = 125^\circ\text{C}$	-	1.7	2.1	V

DYNAMIC CHARACTERISTICS

Junction Capacitance	C_J	$V_R = 10\text{ V}, I_F = 0\text{ A}$	-	120	-	pF
----------------------	-------	---------------------------------------	---	-----	---	-------------

SWITCHING CHARACTERISTICS

Reverse Recovery Time	t_{rr}	$I_F = 1\text{ A}, di/dt = 100\text{ A}/\mu\text{s}, V_R = 30\text{ V}$	-	27	35	ns
			$I_F = 30\text{ A}, di/dt = 100\text{ A}/\mu\text{s}, V_R = 30\text{ V}$	-	36	45
Reverse Recovery Time	t_{rr}	$I_F = 30\text{ A}, di/dt = 200\text{ A}/\mu\text{s}, V_R = 390\text{ V}, T_C = 25^\circ\text{C}$	-	36	-	ns
Reverse Recovery Current	I_{rr}		-	2.9	-	A
Reverse Recovered Charge	Q_{rr}		-	55	-	nC
Reverse Recovery Time	t_{rr}		-	110	-	ns
Softness Factor (t_b/t_a)	S		-	1.9	-	
Reverse Recovery Current	I_{rr}	$I_F = 30\text{ A}, di/dt = 200\text{ A}/\mu\text{s}, V_R = 390\text{ V}, T_C = 125^\circ\text{C}$	-	6	-	A
Reverse Recovered Charge	Q_{rr}		-	450	-	nC
Reverse Recovery Time	t_{rr}		-	60	-	ns
Softness Factor (t_b/t_a)	S		-	1.25	-	
Reverse Recovery Current	I_{rr}		-	21	-	A
Reverse Recovered Charge	Q_{rr}	$I_F = 30\text{ A}, di/dt = 1000\text{ A}/\mu\text{s}, V_R = 390\text{ V}, T_C = 125^\circ\text{C}$	-	730	-	nC
Maximum di/dt During t_b	di_M/dt		-	800	-	$\text{A}/\mu\text{s}$

Product parametric performance is indicated in the Electrical Characteristics for the listed test conditions, unless otherwise noted. Product performance may not be indicated by the Electrical Characteristics if operated under different conditions.

TYPICAL PERFORMANCE CURVES

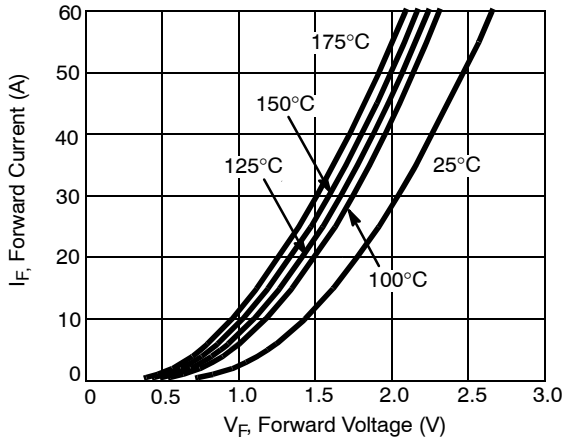

Figure 1. Forward Current vs. Forward Voltage

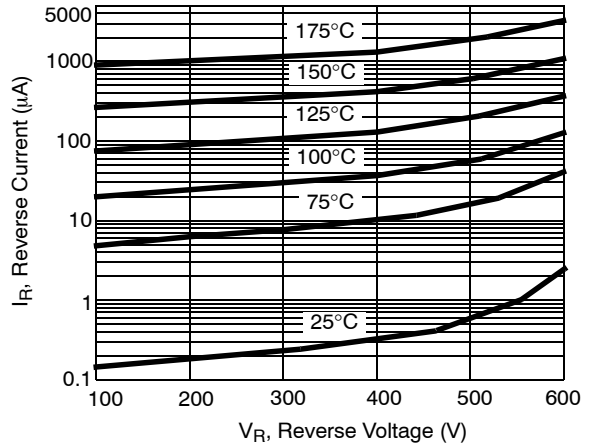

Figure 2. Reverse Current vs. Reverse Voltage

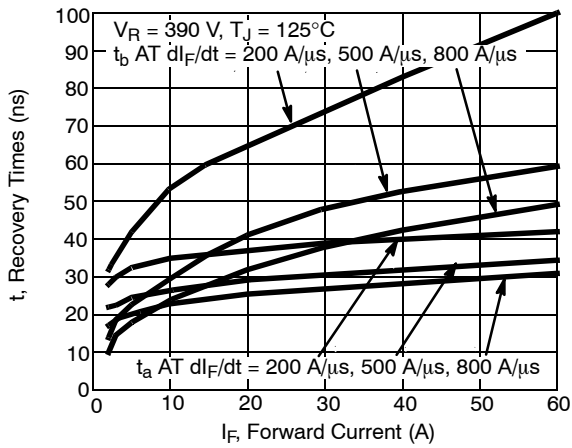

Figure 3. t_a and t_b Curves vs. Forward Current

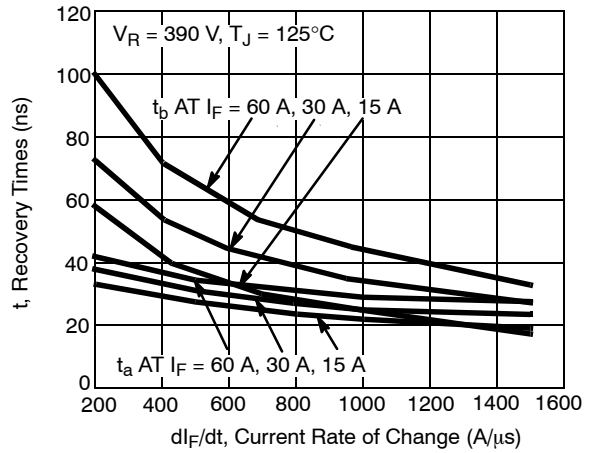

Figure 4. t_a and t_b Curves vs. di_F/dt

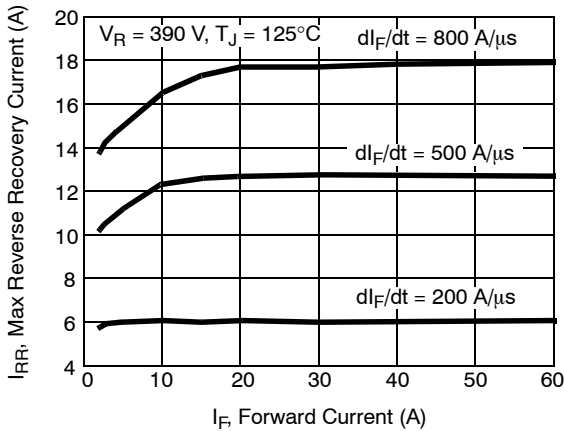

Figure 5. Maximum Reverse Recovery Current vs. Forward Current

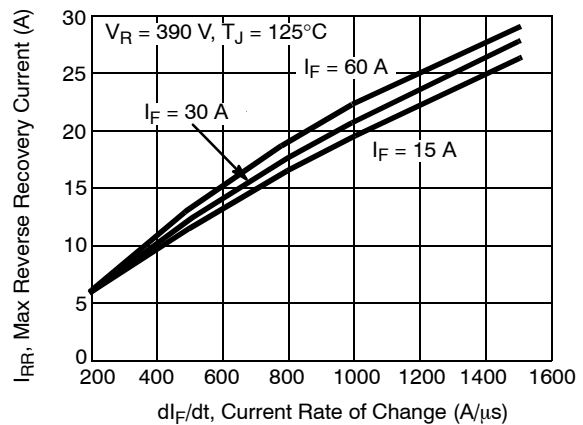

Figure 6. Maximum Reverse Recovery Current vs. di_F/dt

TYPICAL PERFORMANCE CURVES (continued)

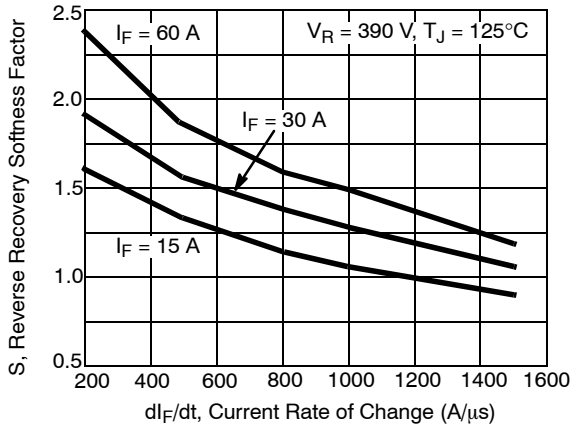

Figure 7. Reverse Recovery Softness Factor vs. di_F/dt

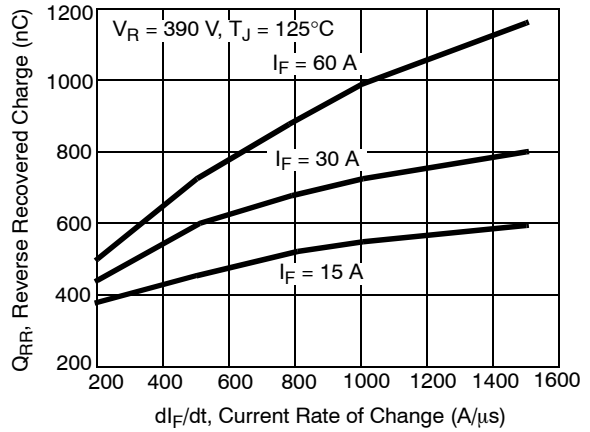

Figure 8. Reverse Recovered Charge vs. di_F/dt

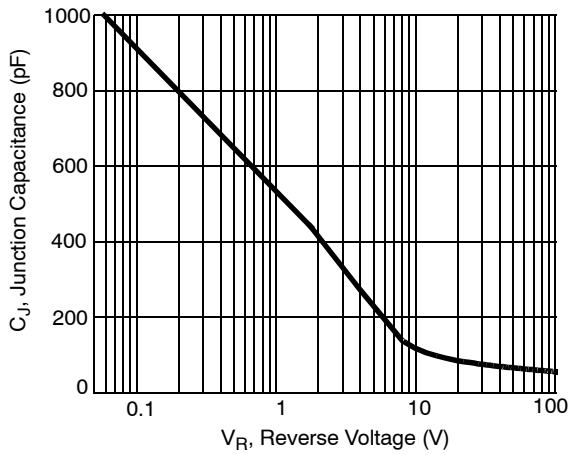

Figure 9. Junction Capacitance vs. Reverse Voltage

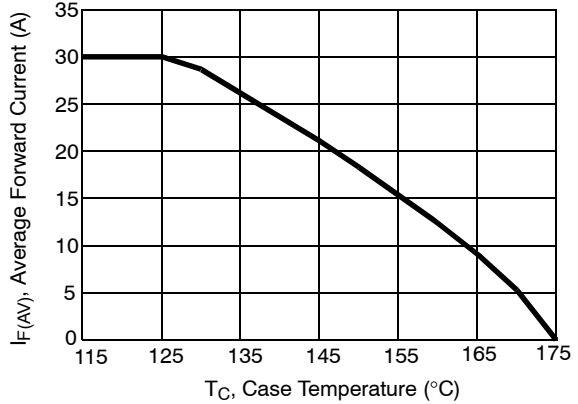

Figure 10. DC Current Derating Curve

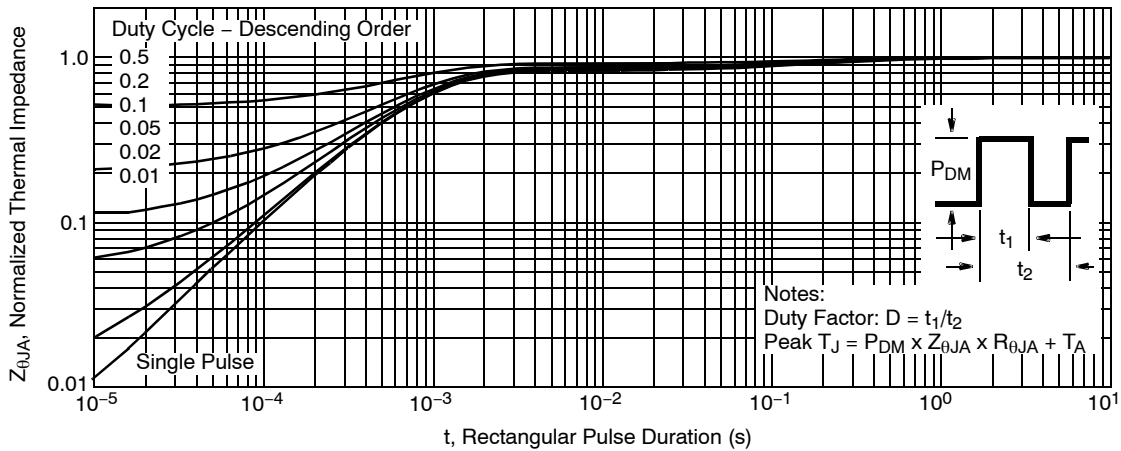

Figure 11. Normalized Maximum Transient Thermal Impedance

ISL9K3060G3

TEST CIRCUIT AND WAVEFORMS

V_{GE} AMPLITUDE AND
 R_G CONTROL di_F/dt
 t_1 AND t_2 Control I_F

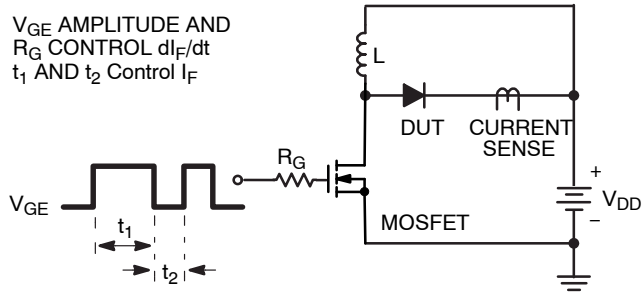

Figure 12. t_{rr} Test Circuit

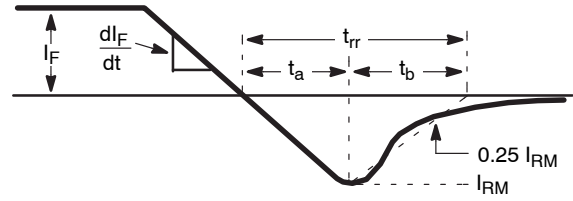

Figure 13. t_{rr} Waveforms and Definitions

$I = 1 \text{ A}$
 $L = 40 \text{ mH}$
 $R < 0.1 \Omega$
 $V_{DD} = 50 \text{ V}$
 $E_{AVL} = 1/2LI^2 [V_{R(AVL)}/(V_{R(AVL)} - V_{DD})]$
 $Q_1 = \text{IGBT } (BV_{CES} > \text{DUT } V_{R(AVL)})$

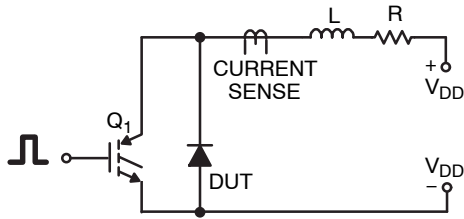

Figure 14. Avalanche Energy Test Circuit

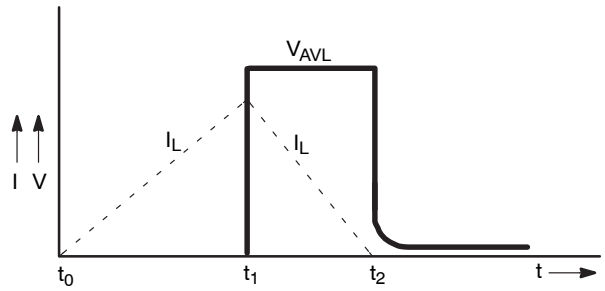
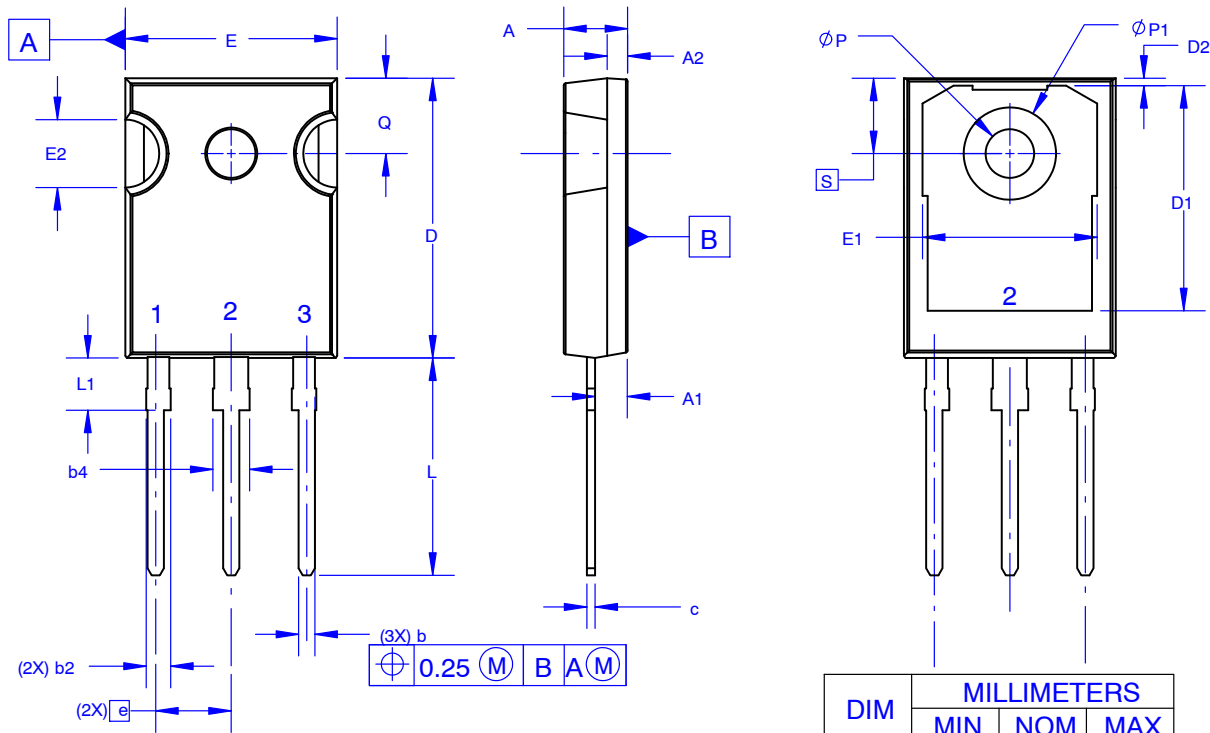

Figure 15. Avalanche Current and Voltage Waveforms



TO-247-3LD SHORT LEAD
CASE 340CK
ISSUE A

DATE 31 JAN 2019



NOTES: UNLESS OTHERWISE SPECIFIED.

- A. DIMENSIONS ARE EXCLUSIVE OF BURRS, MOLD FLASH, AND TIE BAR EXTRUSIONS.
- B. ALL DIMENSIONS ARE IN MILLIMETERS.
- C. DRAWING CONFORMS TO ASME Y14.5 - 2009.
- D. DIMENSION A1 TO BE MEASURED IN THE REGION DEFINED BY L1.
- E. LEAD FINISH IS UNCONTROLLED IN THE REGION DEFINED BY L1.

GENERIC MARKING DIAGRAM*

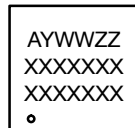

XXXX = Specific Device Code
 A = Assembly Location
 Y = Year
 WW = Work Week
 ZZ = Assembly Lot Code

*This information is generic. Please refer to device data sheet for actual part marking. Pb-Free indicator, "G" or microdot "•", may or may not be present. Some products may not follow the Generic Marking.

DIM	MILLIMETERS		
	MIN	NOM	MAX
A	4.58	4.70	4.82
A1	2.20	2.40	2.60
A2	1.40	1.50	1.60
b	1.17	1.26	1.35
b2	1.53	1.65	1.77
b4	2.42	2.54	2.66
c	0.51	0.61	0.71
D	20.32	20.57	20.82
D1	13.08	~	~
D2	0.51	0.93	1.35
E	15.37	15.62	15.87
E1	12.81	~	~
E2	4.96	5.08	5.20
e	~	5.56	~
L	15.75	16.00	16.25
L1	3.69	3.81	3.93
ØP	3.51	3.58	3.65
ØP1	6.60	6.80	7.00
Q	5.34	5.46	5.58
S	5.34	5.46	5.58

DOCUMENT NUMBER:	98AON13851G	Electronic versions are uncontrolled except when accessed directly from the Document Repository. Printed versions are uncontrolled except when stamped "CONTROLLED COPY" in red.
DESCRIPTION:	TO-247-3LD SHORT LEAD	PAGE 1 OF 1

ON Semiconductor and are trademarks of Semiconductor Components Industries, LLC dba ON Semiconductor or its subsidiaries in the United States and/or other countries. ON Semiconductor reserves the right to make changes without further notice to any products herein. ON Semiconductor makes no warranty, representation or guarantee regarding the suitability of its products for any particular purpose, nor does ON Semiconductor assume any liability arising out of the application or use of any product or circuit, and specifically disclaims any and all liability, including without limitation special, consequential or incidental damages. ON Semiconductor does not convey any license under its patent rights nor the rights of others.

onsemi, **Onsemi**, and other names, marks, and brands are registered and/or common law trademarks of Semiconductor Components Industries, LLC dba "**onsemi**" or its affiliates and/or subsidiaries in the United States and/or other countries. **onsemi** owns the rights to a number of patents, trademarks, copyrights, trade secrets, and other intellectual property. A listing of **onsemi**'s product/patent coverage may be accessed at www.onsemi.com/site/pdf/Patent-Marking.pdf. **onsemi** reserves the right to make changes at any time to any products or information herein, without notice. The information herein is provided "as-is" and **onsemi** makes no warranty, representation or guarantee regarding the accuracy of the information, product features, availability, functionality, or suitability of its products for any particular purpose, nor does **onsemi** assume any liability arising out of the application or use of any product or circuit, and specifically disclaims any and all liability, including without limitation special, consequential or incidental damages. Buyer is responsible for its products and applications using **onsemi** products, including compliance with all laws, regulations and safety requirements or standards, regardless of any support or applications information provided by **onsemi**. "Typical" parameters which may be provided in **onsemi** data sheets and/or specifications can and do vary in different applications and actual performance may vary over time. All operating parameters, including "Typicals" must be validated for each customer application by customer's technical experts. **onsemi** does not convey any license under any of its intellectual property rights nor the rights of others. **onsemi** products are not designed, intended, or authorized for use as a critical component in life support systems or any FDA Class 3 medical devices or medical devices with a same or similar classification in a foreign jurisdiction or any devices intended for implantation in the human body. Should Buyer purchase or use **onsemi** products for any such unintended or unauthorized application, Buyer shall indemnify and hold **onsemi** and its officers, employees, subsidiaries, affiliates, and distributors harmless against all claims, costs, damages, and expenses, and reasonable attorney fees arising out of, directly or indirectly, any claim of personal injury or death associated with such unintended or unauthorized use, even if such claim alleges that **onsemi** was negligent regarding the design or manufacture of the part. **onsemi** is an Equal Opportunity/Affirmative Action Employer. This literature is subject to all applicable copyright laws and is not for resale in any manner.

PUBLICATION ORDERING INFORMATION

LITERATURE FULFILLMENT:

Email Requests to: orderlit@onsemi.com

onsemi Website: www.onsemi.com

TECHNICAL SUPPORT

North American Technical Support:

Voice Mail: 1 800-282-9855 Toll Free USA/Canada

Phone: 011 421 33 790 2910

Europe, Middle East and Africa Technical Support:

Phone: 00421 33 790 2910

For additional information, please contact your local Sales Representative