

Phase Control Thyristors (Stud Version), 230 A



TO-93 (TO-209AB)

FEATURES

- Center amplifying gate
- International standard case TO-93 (TO-209AB)
- Glass-metal seal up to 1200 V
- Compression bonded encapsulation for heavy duty operations such as severe thermal cycling
- Designed and qualified for industrial level
- Material categorization: for definitions of compliance please see www.vishay.com/doc?99912

RoHS
COMPLIANT

PRIMARY CHARACTERISTICS

$I_{T(AV)}$	230 A
V_{DRM}/V_{RRM}	400 V, 800 V, 1200 V
V_{TM}	1.55 V
I_{GT}	150 mA
T_J	-40 °C to +125 °C
Package	TO-93 (TO-209AB)
Circuit configuration	Single SCR

TYPICAL APPLICATIONS

- DC motor controls
- Controlled DC power supplies
- AC controllers

MAJOR RATINGS AND CHARACTERISTICS

PARAMETER	TEST CONDITIONS	VALUES	UNITS
$I_{T(AV)}$		230	A
	T_C	85	°C
$I_{T(RMS)}$		360	A
I_{TSM}	50 Hz	5700	A
	60 Hz	5970	
I^2t	50 Hz	163	kA ² s
	60 Hz	149	
V_{DRM}/V_{RRM}		400 to 1200	V
t_q	Typical	100	µs
T_J		-40 to 125	°C

ELECTRICAL SPECIFICATIONS

VOLTAGE RATINGS

TYPE NUMBER	VOLTAGE CODE	V_{DRM}/V_{RRM} , MAXIMUM REPETITIVE PEAK AND OFF-STATE VOLTAGE V	V_{RSM} , MAXIMUM NON-REPETITIVE PEAK VOLTAGE V	I_{DRM}/I_{RRM} MAXIMUM AT $T_J = T_J$ MAXIMUM mA
VS-ST230S	04	400	500	30
	08	800	900	
	12	1200	1300	



ABSOLUTE MAXIMUM RATINGS					
PARAMETER	SYMBOL	TEST CONDITIONS		VALUES	UNITS
Maximum average on-state current at case temperature	$I_{T(AV)}$	180° conduction, half sine wave		230	A
				85	°C
Maximum RMS on-state current	$I_{T(RMS)}$	DC at 78 °C case temperature		360	A
Maximum peak, one-cycle non-repetitive surge current	I_{TSM}	t = 10 ms	No voltage reapplied	5700	
		t = 8.3 ms	No voltage reapplied	5970	
		t = 10 ms	100 % V_{RRM}	4800	
		t = 8.3 ms	reapplied	5000	
Maximum I^2t for fusing	I^2t	t = 10 ms	No voltage reapplied	163	kA ² s
		t = 8.3 ms	No voltage reapplied	148	
		t = 10 ms	100 % V_{RRM}	115	
		t = 8.3 ms	reapplied	105	
Maximum $I^2\sqrt{t}$ for fusing	$I^2\sqrt{t}$	t = 0.1 to 10 ms, no voltage reapplied		1630	kA ² √s
Low level value of threshold voltage	$V_{T(TO)1}$	$(16.7\% \times \pi \times I_{T(AV)} < I < \pi \times I_{T(AV)})$, $T_J = T_J$ maximum		0.92	V
High level value of threshold voltage	$V_{T(TO)2}$	$(I > \pi \times I_{T(AV)})$, $T_J = T_J$ maximum		0.98	
Low level value of on-state slope resistance	r_{t1}	$(16.7\% \times \pi \times I_{T(AV)} < I < \pi \times I_{T(AV)})$, $T_J = T_J$ maximum		0.88	mΩ
High level value of on-state slope resistance	r_{t2}	$(I > \pi \times I_{T(AV)})$, $T_J = T_J$ maximum		0.81	
Maximum on-state voltage	V_{TM}	$I_{pk} = 720$ A, $T_J = T_J$ maximum, $t_p = 10$ ms sine pulse		1.55	V
Maximum holding current	I_H	$T_J = 25$ °C, anode supply 12 V resistive load		600	mA
Maximum (typical) latching current	I_L			1000 (300)	

SWITCHING					
PARAMETER	SYMBOL	TEST CONDITIONS		VALUES	UNITS
Maximum non-repetitive rate of rise of turned-on current	di/dt	Gate drive 20 V, 20 Ω, $t_r \leq 1$ μs $T_J = T_J$ maximum, anode voltage $\leq 80\%$ V_{DRM}		1000	A/μs
Typical delay time	t_d	Gate current 1 A, $di_g/dt = 1$ A/μs $V_d = 0.67\%$ V_{DRM} , $T_J = 25$ °C		1.0	μs
Typical turn-off time	t_q	$I_{TM} = 300$ A, $T_J = T_J$ maximum, $di_F/dt = 20$ A/μs, $V_R = 50$ V, $dV/dt = 20$ V/μs, gate 0 V 100 Ω, $t_p = 500$ μs		100	

BLOCKING					
PARAMETER	SYMBOL	TEST CONDITIONS		VALUES	UNITS
Maximum critical rate of rise of off-state voltage	dV/dt	$T_J = T_J$ maximum linear to 80 % rated V_{DRM}		500	V/μs
Maximum peak reverse and off-state leakage current	I_{RRM} , I_{DRM}	$T_J = T_J$ maximum, rated V_{DRM}/V_{RRM} applied		30	mA



TRIGGERING					
PARAMETER	SYMBOL	TEST CONDITIONS	VALUES		UNITS
			TYP.	MAX.	
Maximum peak gate power	P_{GM}	$T_J = T_J$ maximum, $t_p \leq 5$ ms	10.0		W
Maximum average gate power	$P_{G(AV)}$	$T_J = T_J$ maximum, $f = 50$ Hz, $d\% = 50$	2.0		
Maximum peak positive gate current	I_{GM}	$T_J = T_J$ maximum, $t_p \leq 5$ ms	3.0		A
Maximum peak positive gate voltage	$+V_{GM}$	$T_J = T_J$ maximum, $t_p \leq 5$ ms	20		V
Maximum peak negative gate voltage	$-V_{GM}$		5.0		
DC gate current required to trigger	I_{GT}	$T_J = -40$ °C	180	-	mA
		$T_J = 25$ °C	90	150	
		$T_J = 125$ °C	40	-	
DC gate voltage required to trigger	V_{GT}	$T_J = -40$ °C	2.9	-	V
		$T_J = 25$ °C	1.8	3.0	
		$T_J = 125$ °C	1.2	-	
DC gate current not to trigger	I_{GD}	$T_J = T_J$ maximum	10		mA
DC gate voltage not to trigger	V_{GD}		0.25		V

THERMAL AND MECHANICAL SPECIFICATIONS				
PARAMETER	SYMBOL	TEST CONDITIONS	VALUES	UNITS
Maximum operating junction temperature range	T_J		-40 to 125	°C
Maximum storage temperature range	T_{Stg}		-40 to 150	
Maximum thermal resistance, junction to case	R_{thJC}	DC operation	0.10	K/W
Maximum thermal resistance, case to heatsink	R_{thC-hs}	Mounting surface, smooth, flat and greased	0.04	
Mounting torque, ± 10 %		Non-lubricated threads	31 (275)	N · m (lbf · in)
		Lubricated threads	24.5 (210)	
Approximate weight			280	g
Case style		See dimensions - link at the end of datasheet	TO-93 (TO-209AB)	

ΔR_{thJC} CONDUCTION				
CONDUCTION ANGLE	SINUSOIDAL CONDUCTION	RECTANGULAR CONDUCTION	TEST CONDITIONS	UNITS
180°	0.016	0.012	$T_J = T_J$ maximum	K/W
120°	0.019	0.020		
90°	0.025	0.027		
60°	0.036	0.037		
30°	0.060	0.060		

Note

- The table above shows the increment of thermal resistance R_{thJC} when devices operate at different conduction angles than DC

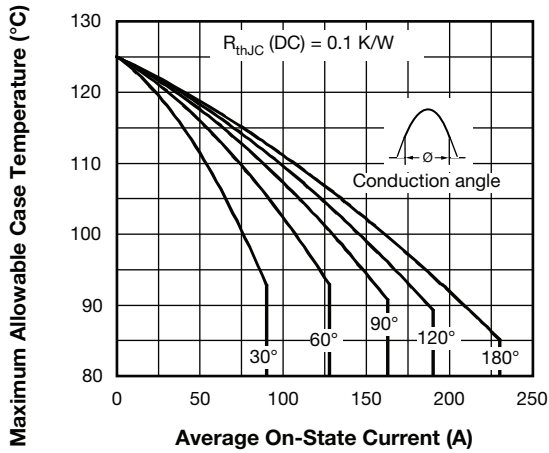

Fig. 1 - Current Ratings Characteristics

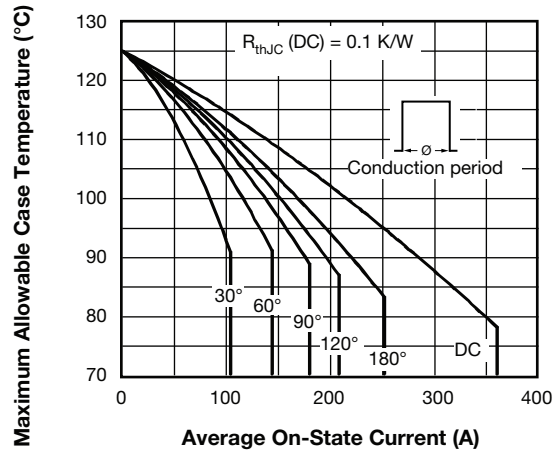

Fig. 2 - Current Ratings Characteristics

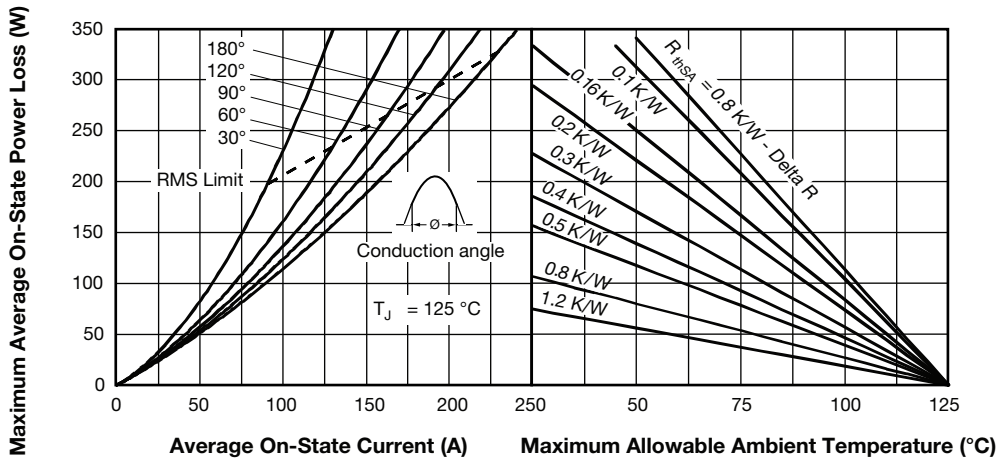

Fig. 3 - On-State Power Loss Characteristics

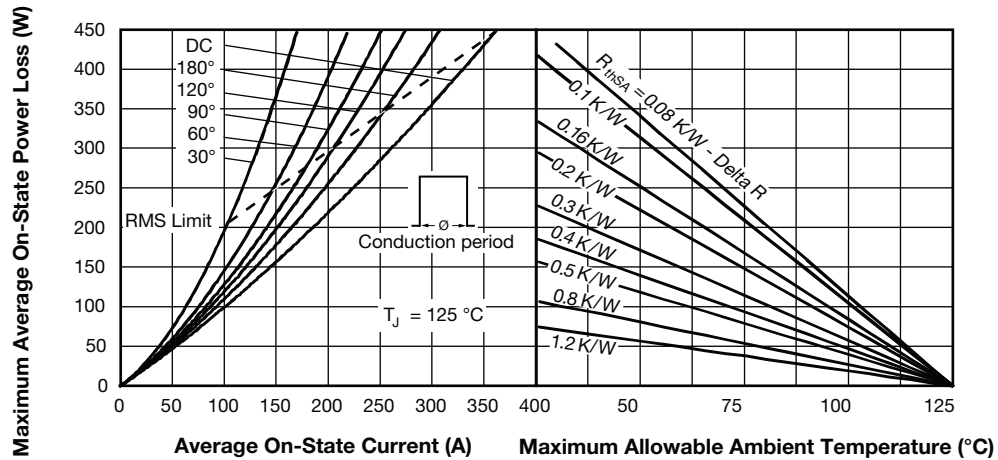

Fig. 4 - On-State Power Loss Characteristics

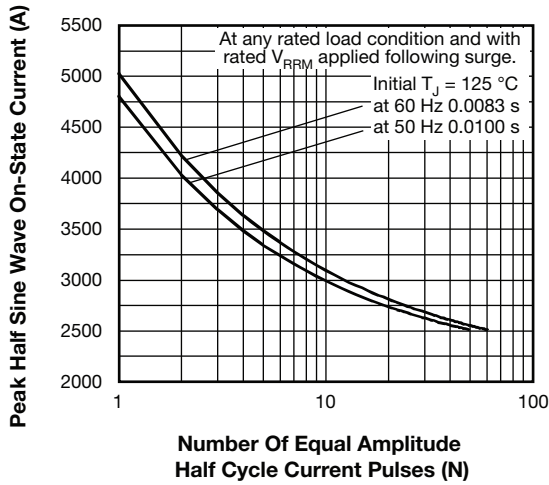

Fig. 5 - Maximum Non-Repetitive Surge Current

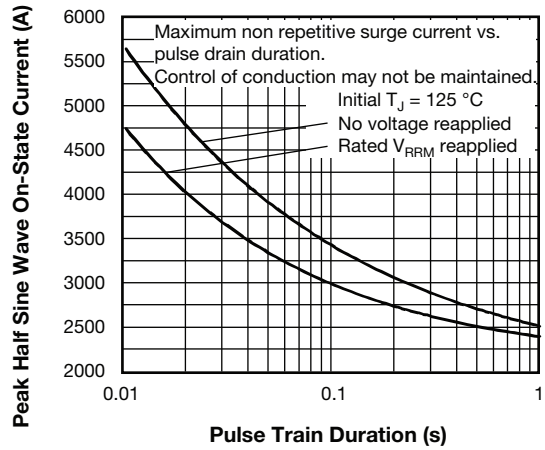

Fig. 6 - Maximum Non-Repetitive Surge Current

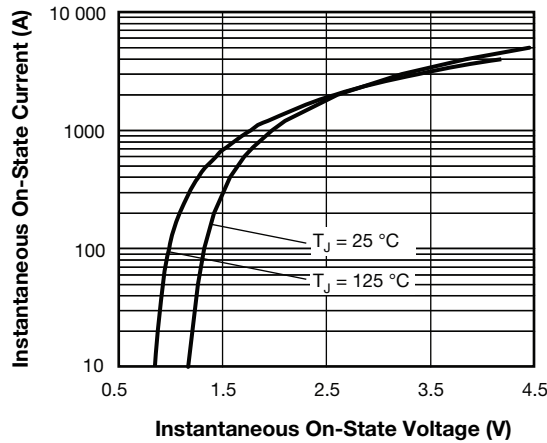

Fig. 7 - On-State Voltage Drop Characteristics

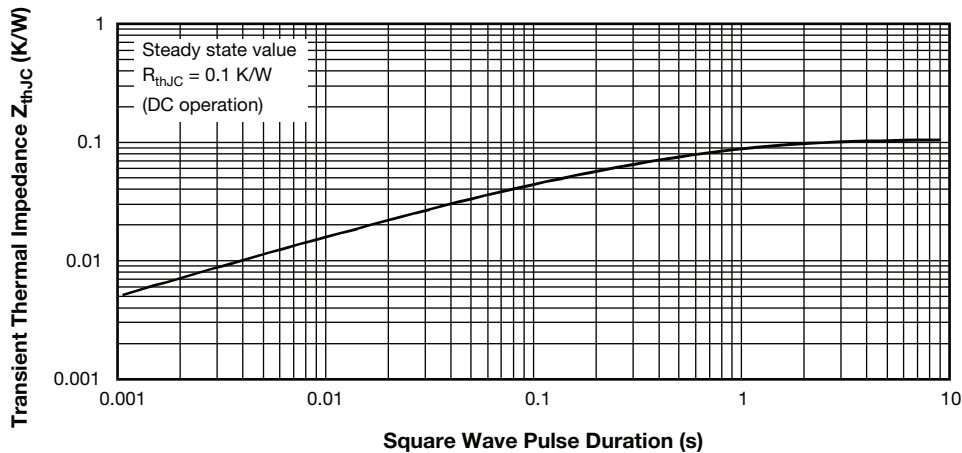

Fig. 8 - Thermal Impedance Z_{thJC} Characteristics

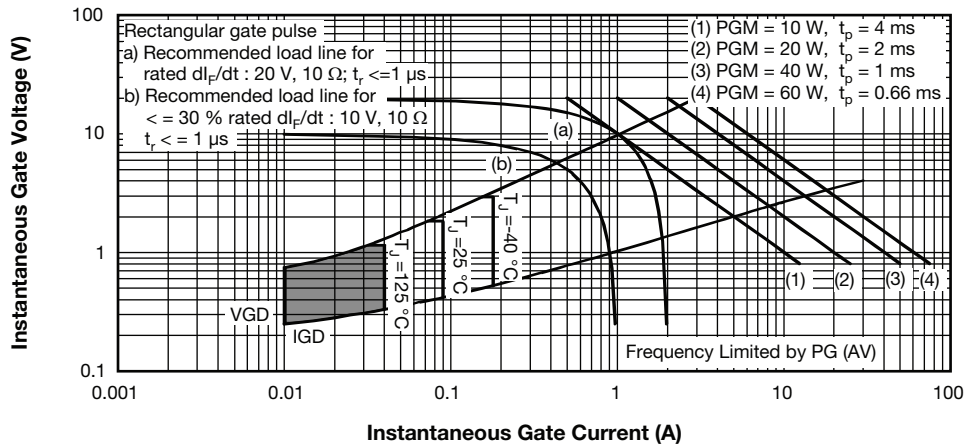

Fig. 9 - Gate Characteristics

ORDERING INFORMATION TABLE

Device code	VS-	ST	23	0	S	12	P	0	V	PbF
	(1)	(2)	(3)	(4)	(5)	(6)	(7)	(8)	(9)	(10)

- 1** - Vishay Semiconductors product
- 2** - Thyristor
- 3** - Essential part number
- 4** - 0 = converter grade
- 5** - S = compression bonding stud
- 6** - Voltage code x 100 = V_{RRM} (see Voltage Ratings table)
- 7** - P = stud base 3/4"-16UNF2A threads
- 8** - 0 = eyelet terminals (gate and auxiliary cathode leads)
1 = fast-on terminals (gate and auxiliary cathode leads)
- 9** - V = glass-metal seal (only up to 1200 V)
- 10** - None = standard production
PbF = lead (Pb)-free

Note: For metric device M16 x 1.5 contact factory

LINKS TO RELATED DOCUMENTS

Dimensions

www.vishay.com/doc?95082



TO-209AB (TO-93)

DIMENSIONS in millimeters (inches)

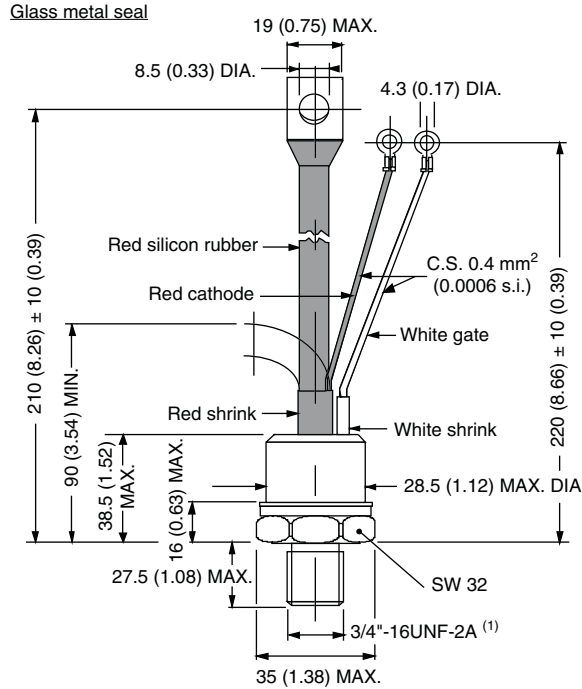

Note

(1) For metric device: M16 x 1.5 - length 21 (0.83) maximum



Disclaimer

ALL PRODUCT, PRODUCT SPECIFICATIONS AND DATA ARE SUBJECT TO CHANGE WITHOUT NOTICE TO IMPROVE RELIABILITY, FUNCTION OR DESIGN OR OTHERWISE.

Vishay Intertechnology, Inc., its affiliates, agents, and employees, and all persons acting on its or their behalf (collectively, "Vishay"), disclaim any and all liability for any errors, inaccuracies or incompleteness contained in any datasheet or in any other disclosure relating to any product.

Vishay makes no warranty, representation or guarantee regarding the suitability of the products for any particular purpose or the continuing production of any product. To the maximum extent permitted by applicable law, Vishay disclaims (i) any and all liability arising out of the application or use of any product, (ii) any and all liability, including without limitation special, consequential or incidental damages, and (iii) any and all implied warranties, including warranties of fitness for particular purpose, non-infringement and merchantability.

Statements regarding the suitability of products for certain types of applications are based on Vishay's knowledge of typical requirements that are often placed on Vishay products in generic applications. Such statements are not binding statements about the suitability of products for a particular application. It is the customer's responsibility to validate that a particular product with the properties described in the product specification is suitable for use in a particular application. Parameters provided in datasheets and / or specifications may vary in different applications and performance may vary over time. All operating parameters, including typical parameters, must be validated for each customer application by the customer's technical experts. Product specifications do not expand or otherwise modify Vishay's terms and conditions of purchase, including but not limited to the warranty expressed therein.

Hyperlinks included in this datasheet may direct users to third-party websites. These links are provided as a convenience and for informational purposes only. Inclusion of these hyperlinks does not constitute an endorsement or an approval by Vishay of any of the products, services or opinions of the corporation, organization or individual associated with the third-party website. Vishay disclaims any and all liability and bears no responsibility for the accuracy, legality or content of the third-party website or for that of subsequent links.

Except as expressly indicated in writing, Vishay products are not designed for use in medical, life-saving, or life-sustaining applications or for any other application in which the failure of the Vishay product could result in personal injury or death. Customers using or selling Vishay products not expressly indicated for use in such applications do so at their own risk. Please contact authorized Vishay personnel to obtain written terms and conditions regarding products designed for such applications.

No license, express or implied, by estoppel or otherwise, to any intellectual property rights is granted by this document or by any conduct of Vishay. Product names and markings noted herein may be trademarks of their respective owners.