

May.1.2023 Copyright 2023 HIROSE ELECTRIC CO., LTD. All Rights Reserved.
In case of consideration for using Automotive equipment / device which demand high reliability, kindly contact our sales window correspondents.

COUNT	DESCRIPTION OF REVISIONS	BY	CHKD	DATE	COUNT	DESCRIPTION OF REVISIONS	BY	CHKD	DATE
△				..	△				..
△				..	△				..
△				..	△				..

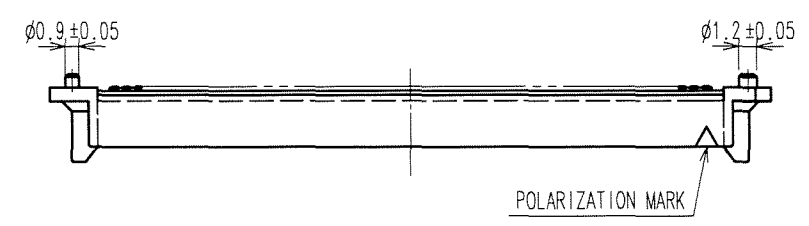

RECOMMENDED LAND PATTERN DIMENSION OF PCB(MOUNTING SIDE)

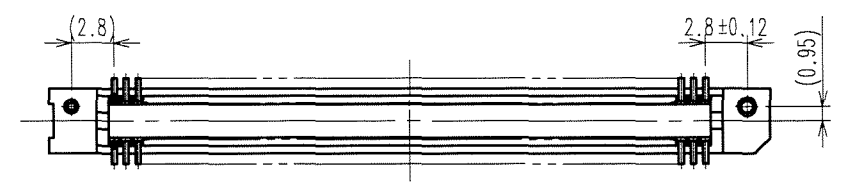
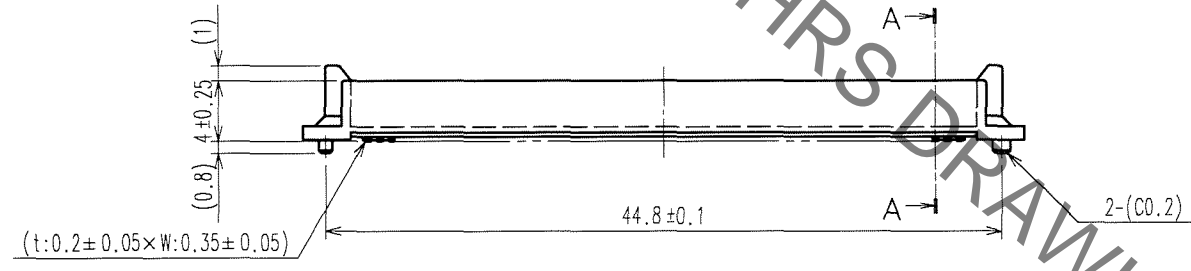
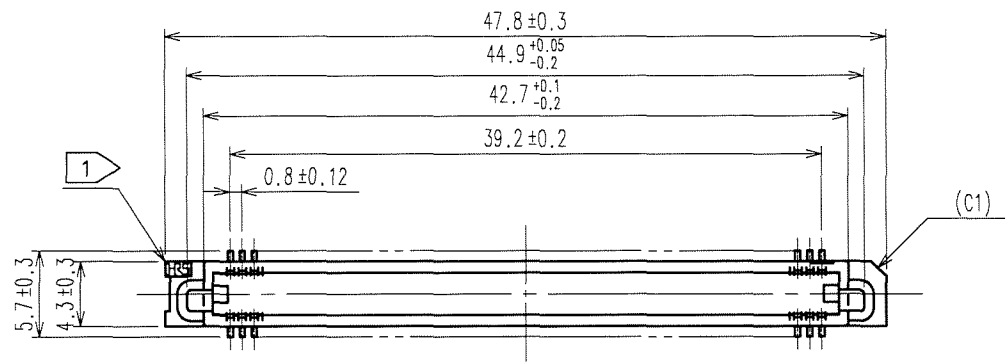
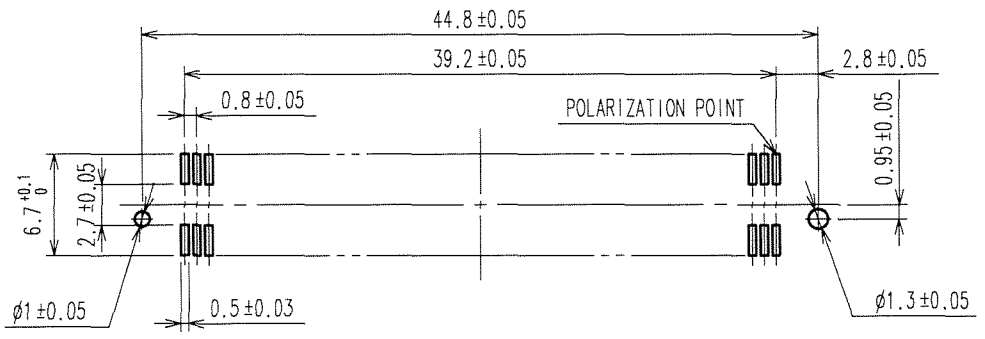

A-A(10:1)

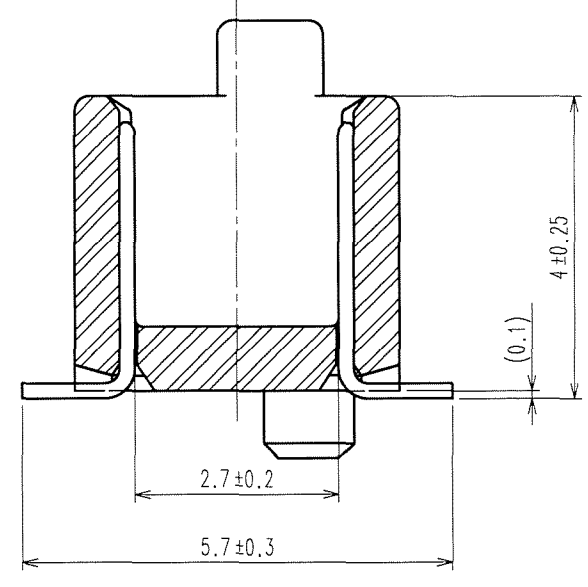

- NOTE
- 1 HRS MARK SHALL BE OPTIONAL.
 - 2 LEAD CO-PLANARITY SHALL BE 0.1mm MAX.
 - 3 THE DIMENSIONS IN PARENTHESES ARE FOR REFERENCE.
 - 4 TUBE PACKAGING SHALL BE APPLIED FOR THIS PRODUCT. SEE NEXT PAGE FOR DETAILS.
 - 5 THIS PRODUCT HAS TAPE FOR VACUUM PICKUP. SEE NEXT PAGE FOR DETAIL OF STICKING POSITION, ETC.
 - 6 FOR MODIFICATION, ETC, PREVENTIVE HOLE FOR SINK MARK MAY BE ADDED ACCORDING TO CIRCUMSTANCES.

TO
PCK

1	PPS	LIGHT BROWN (UL94V-0)	2	PHOSPHOR BRONZE	CONTACT AREA:GOLD 0.1μ m min. LEAD AREA:GOLD FLASH UNDER PLATING:NICKEL 1μ m min.	
NO.	MATERIAL	FINISH, REMARKS	NO.	MATERIAL	FINISH, REMARKS	
CODE NO. (OLD)		DRAWN	DESIGNED	CHECKED	APPROVED	RELEASED
		K.NAKAMURA	K.NAKAMURA	K.Ogawa	H.Okawa	
		07.05.15	07.05.15	'07.05.15	'07.05.15	
DRAWING NO. EDC3-084974-21			PART NO. FX6-100P-0.8SV(91)			
SCALE 2 : 1			CODE NO. CL576-0008-2-91			
UNITS mm			HIROSE ELECTRIC CO., LTD			

May.1.2023 Copyright 2023 HIROSE ELECTRIC CO., LTD. All Rights Reserved.
In case of consideration for using Automotive equipment / device which demand high reliability, kindly contact our sales window correspondents.

COUNT	DESCRIPTION OF REVISIONS	BY	CHKD	DATE	COUNT	DESCRIPTION OF REVISIONS	BY	CHKD	DATE
△				..	△				..
△				..	△				..
△				..	△				..

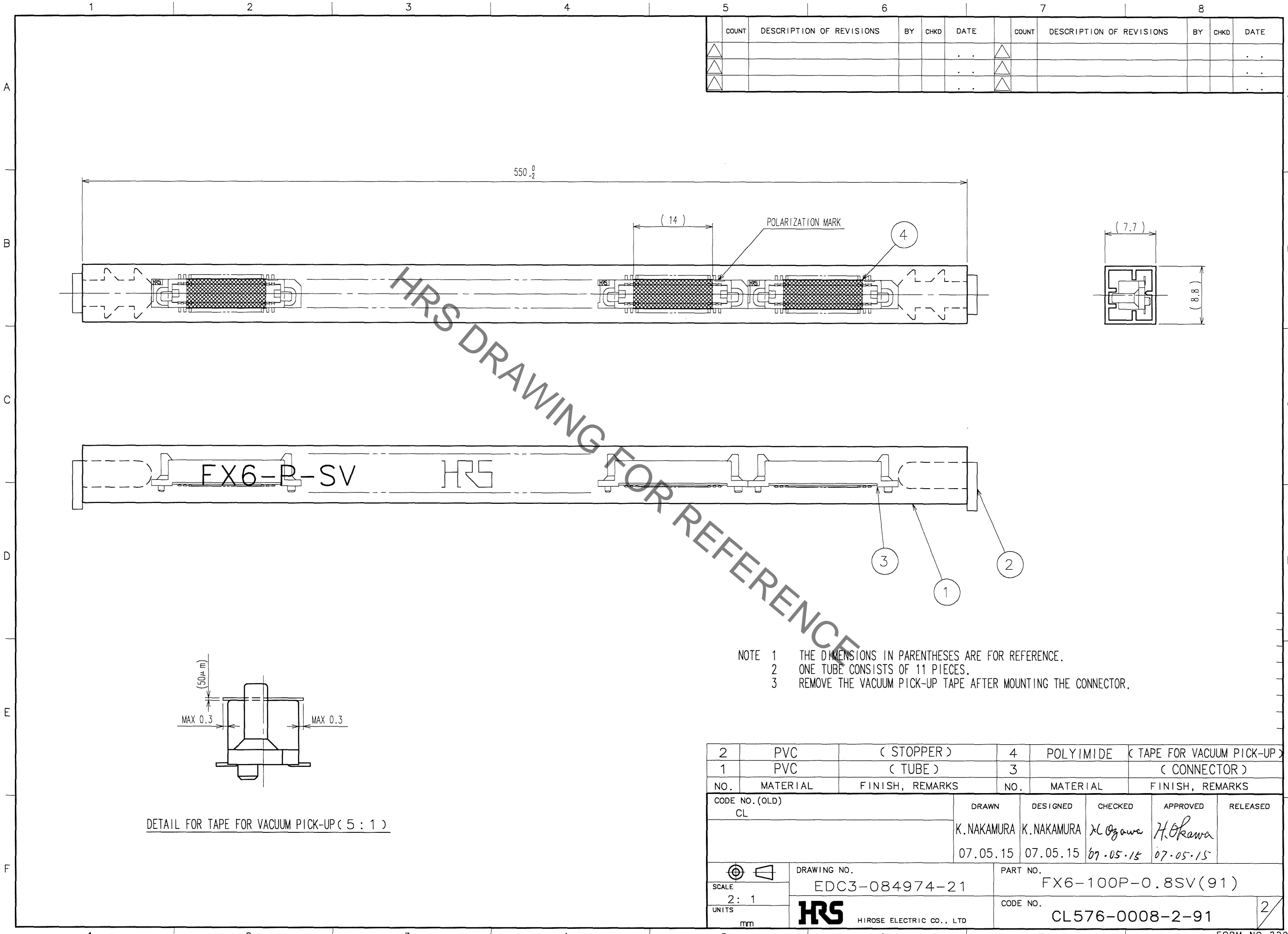

NOTE 1 THE DIMENSIONS IN PARENTHESES ARE FOR REFERENCE.
 2 ONE TUBE CONSISTS OF 11 PIECES.
 3 REMOVE THE VACUUM PICK-UP TAPE AFTER MOUNTING THE CONNECTOR.

2	PVC	(STOPPER)	4	POLYIMIDE	(TAPE FOR VACUUM PICK-UP)
1	PVC	(TUBE)	3		(CONNECTOR)
NO.	MATERIAL	FINISH, REMARKS	NO.	MATERIAL	FINISH, REMARKS

CODE NO. (OLD) CL	DRAWN K.NAKAMURA 07.05.15	DESIGNED K.NAKAMURA 07.05.15	CHECKED <i>K. Ozawa</i> 07.05.15	APPROVED <i>H. Okawa</i> 07.05.15	RELEASED
----------------------	---------------------------------	------------------------------------	--	---	----------

SCALE 2: 1	DRAWING NO. EDC3-084974-21	PART NO. FX6-100P-0.8SV(91)
UNITS mm	HRS HIROSE ELECTRIC CO., LTD	CODE NO. CL576-0008-2-91

DETAIL FOR TAPE FOR VACUUM PICK-UP (5 : 1)

TO