

74AUP1G38

Low-power 2-input NAND gate (open drain)

Rev. 9 — 16 August 2022

Product data sheet

1. General description

The 74AUP1G38 is a single 2-input NAND gate with open-drain output. Schmitt-trigger action at all inputs makes the circuit tolerant of slower input rise and fall times. This device ensures very low static and dynamic power consumption across the entire V_{CC} range from 0.8 V to 3.6 V. This device is fully specified for partial power down applications using I_{OFF} . The I_{OFF} circuitry disables the output, preventing the potentially damaging backflow current through the device when it is powered down.

2. Features and benefits

- Wide supply voltage range from 0.8 V to 3.6 V
- CMOS low power dissipation
- High noise immunity
- Complies with JEDEC standards:
 - JESD8-12 (0.8 V to 1.3 V)
 - JESD8-11 (0.9 V to 1.65 V)
 - JESD8-7 (1.65 V to 1.95 V)
 - JESD8-5 (2.3 V to 2.7 V)
 - JESD8C (2.7 V to 3.6 V)
- ESD protection:
 - HBM JESD22-A114F Class 3A exceeds 5000 V
 - MM JESD22-A115-A exceeds 200 V
 - CDM JESD22-C101E exceeds 1000 V
- Low static power consumption; $I_{CC} = 0.9 \mu\text{A}$ (maximum)
- Latch-up performance exceeds 100 mA per JESD 78 Class II
- Overvoltage tolerant inputs to 3.6 V
- Low noise overshoot and undershoot < 10 % of V_{CC}
- I_{OFF} circuitry provides partial Power-down mode operation
- Multiple package options
- Specified from -40 °C to +85 °C and -40 °C to +125 °C

3. Ordering information

Table 1. Ordering information

Type number	Package			Version
	Temperature range	Name	Description	
74AUP1G38GW	-40 °C to +125 °C	TSSOP5	plastic thin shrink small outline package; 5 leads; body width 1.25 mm	SOT353-1
74AUP1G38GM	-40 °C to +125 °C	XSON6	plastic extremely thin small outline package; no leads; 6 terminals; body 1 × 1.45 × 0.5 mm	SOT886
74AUP1G38GN	-40 °C to +125 °C	XSON6	extremely thin small outline package; no leads; 6 terminals; body 0.9 × 1.0 × 0.35 mm	SOT1115
74AUP1G38GS	-40 °C to +125 °C	XSON6	extremely thin small outline package; no leads; 6 terminals; body 1.0 × 1.0 × 0.35 mm	SOT1202
74AUP1G38GX	-40 °C to +125 °C	X2SON5	plastic thermal enhanced extremely thin small outline package; no leads; 5 terminals; body 0.8 × 0.8 × 0.32 mm	SOT1226-3

4. Marking

Table 2. Marking

Type number	Marking code[1]
74AUP1G38GW	aB
74AUP1G38GM	aB
74AUP1G38GN	aB
74AUP1G38GS	aB
74AUP1G38GX	aB

[1] The pin 1 indicator is located on the lower left corner of the device, below the marking code.

5. Functional diagram

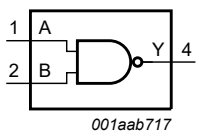
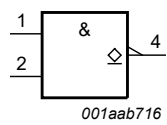
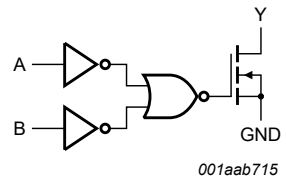
 <p>001aab717</p>	 <p>001aab716</p>	 <p>001aab715</p>
Fig. 1. Logic symbol	Fig. 2. IEC logic symbol	Fig. 3. Logic diagram

6. Pinning information

6.1. Pinning

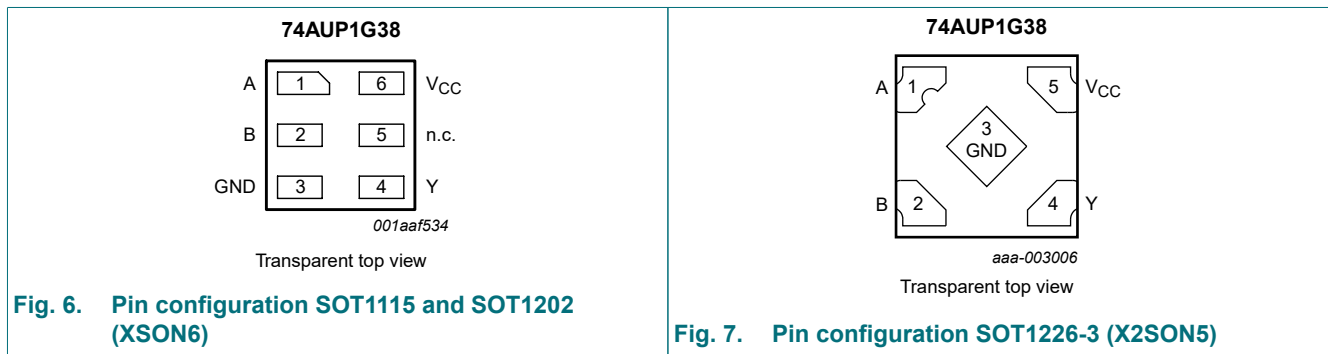
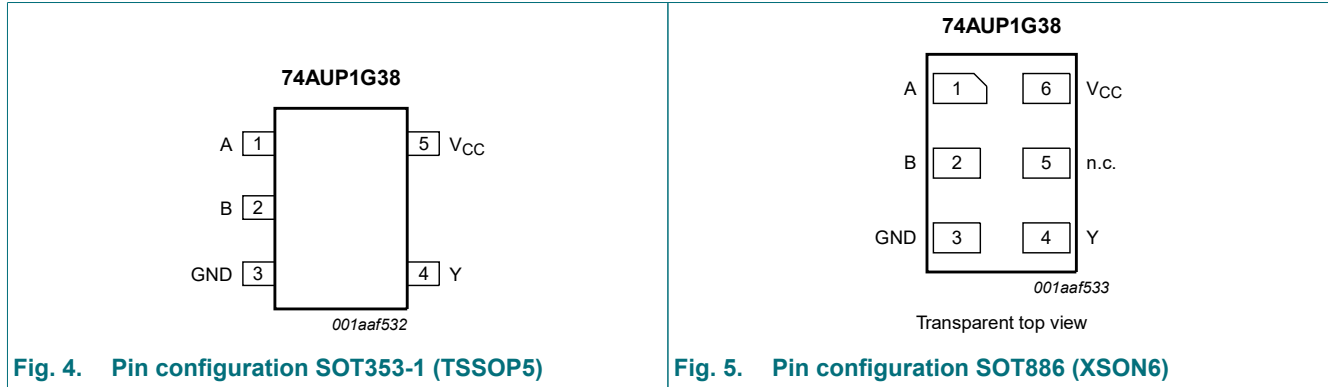

6.2. Pin description

Table 3. Pin description

Symbol	Pin		Description
	TSSOP5 and X2SON5	XSON6	
A	1	1	data input
B	2	2	data input
GND	3	3	ground (0 V)
Y	4	4	data output
n.c.	-	5	not connected
V _{CC}	5	6	supply voltage

7. Functional description

Table 4. Function table

H = HIGH voltage level; L = LOW voltage level; Z = high-impedance OFF state.

Input		Output
A	B	Y
L	L	Z
L	H	Z
H	L	Z
H	H	L

8. Limiting values

Table 5. Limiting values

In accordance with the Absolute Maximum Rating System (IEC 60134). Voltages are referenced to GND (ground = 0 V).

Symbol	Parameter	Conditions	Min	Max	Unit
V_{CC}	supply voltage		-0.5	+4.6	V
I_{IK}	input clamping current	$V_I < 0\text{ V}$	-50	-	mA
V_I	input voltage		[1] -0.5	+4.6	V
I_{OK}	output clamping current	$V_O < 0\text{ V}$	-50	-	mA
V_O	output voltage	Active mode and Power-down mode	[1] -0.5	+4.6	V
I_O	output current	$V_O = 0\text{ V to }V_{CC}$	-	+20	mA
I_{CC}	supply current		-	+50	mA
I_{GND}	ground current		-50	-	mA
T_{stg}	storage temperature		-65	+150	°C
P_{tot}	total power dissipation	$T_{amb} = -40\text{ °C to }+125\text{ °C}$	[2] -	250	mW

[1] The minimum input and output voltage ratings may be exceeded if the input and output current ratings are observed.

[2] For SOT353-1 (TSSOP5) package: P_{tot} derates linearly with 3.3 mW/K above 74 °C.

For SOT886 (XSON6) package: P_{tot} derates linearly with 3.3 mW/K above 74 °C.

For SOT1115 (XSON6) package: P_{tot} derates linearly with 3.2 mW/K above 71 °C.

For SOT1202 (XSON6) package: P_{tot} derates linearly with 3.3 mW/K above 74 °C.

For SOT1226-3 (X2SON5) package: P_{tot} derates linearly with 3.0 mW/K above 67 °C.

9. Recommended operating conditions

Table 6. Recommended operating conditions

Symbol	Parameter	Conditions	Min	Max	Unit
V_{CC}	supply voltage		0.8	3.6	V
V_I	input voltage		0	3.6	V
V_O	output voltage	Active mode and Power-down mode	0	3.6	V
T_{amb}	ambient temperature		-40	+125	°C
$\Delta t/\Delta V$	input transition rise and fall rate	$V_{CC} = 0.8\text{ V to }3.6\text{ V}$	0	200	ns/V

10. Static characteristics

Table 7. Static characteristics

At recommended operating conditions; voltages are referenced to GND (ground = 0 V).

Symbol	Parameter	Conditions	Min	Typ	Max	Unit
T_{amb} = 25 °C						
V _{IH}	HIGH-level input voltage	V _{CC} = 0.8 V	0.70 × V _{CC}	-	-	V
		V _{CC} = 0.9 V to 1.95 V	0.65 × V _{CC}	-	-	V
		V _{CC} = 2.3 V to 2.7 V	1.6	-	-	V
		V _{CC} = 3.0 V to 3.6 V	2.0	-	-	V
V _{IL}	LOW-level input voltage	V _{CC} = 0.8 V	-	-	0.30 × V _{CC}	V
		V _{CC} = 0.9 V to 1.95 V	-	-	0.35 × V _{CC}	V
		V _{CC} = 2.3 V to 2.7 V	-	-	0.7	V
		V _{CC} = 3.0 V to 3.6 V	-	-	0.9	V
V _{OL}	LOW-level output voltage	V _I = V _{IH} or V _{IL}				
		I _O = 20 μA; V _{CC} = 0.8 V to 3.6 V	-	-	0.1	V
		I _O = 1.1 mA; V _{CC} = 1.1 V	-	-	0.3 × V _{CC}	V
		I _O = 1.7 mA; V _{CC} = 1.4 V	-	-	0.31	V
		I _O = 1.9 mA; V _{CC} = 1.65 V	-	-	0.31	V
		I _O = 2.3 mA; V _{CC} = 2.3 V	-	-	0.31	V
		I _O = 3.1 mA; V _{CC} = 2.3 V	-	-	0.44	V
		I _O = 2.7 mA; V _{CC} = 3.0 V	-	-	0.31	V
I _O = 4.0 mA; V _{CC} = 3.0 V	-	-	0.44	V		
I _I	input leakage current	V _I = GND to 3.6 V; V _{CC} = 0 V to 3.6 V	-	-	±0.1	μA
I _{OZ}	OFF-state output current	V _I = V _{IH} or V _{IL} (and at least one input LOW); V _O = 0 V to 3.6 V; V _{CC} = 0 V to 3.6 V	-	-	±0.1	μA
I _{OFF}	power-off leakage current	V _I or V _O = 0 V to 3.6 V; V _{CC} = 0 V	-	-	±0.2	μA
ΔI _{OFF}	additional power-off leakage current	V _I or V _O = 0 V to 3.6 V; V _{CC} = 0 V to 0.2 V	-	-	±0.2	μA
I _{CC}	supply current	V _I = GND or V _{CC} ; I _O = 0 A; V _{CC} = 0.8 V to 3.6 V	-	-	0.5	μA
ΔI _{CC}	additional supply current	V _I = V _{CC} - 0.6 V; I _O = 0 A; V _{CC} = 3.3 V	-	-	40	μA
C _I	input capacitance	V _{CC} = 0 V to 3.6 V; V _I = GND or V _{CC}	-	0.8	-	pF
C _O	output capacitance	output enabled; V _O = GND; V _{CC} = 0 V	-	1.7	-	pF
		output disabled; V _O = GND; V _{CC} = 0 V	-	1.1	-	pF

Low-power 2-input NAND gate (open drain)

Symbol	Parameter	Conditions	Min	Typ	Max	Unit
T_{amb} = -40 °C to +85 °C						
V _{IH}	HIGH-level input voltage	V _{CC} = 0.8 V	0.70 × V _{CC}	-	-	V
		V _{CC} = 0.9 V to 1.95 V	0.65 × V _{CC}	-	-	V
		V _{CC} = 2.3 V to 2.7 V	1.6	-	-	V
		V _{CC} = 3.0 V to 3.6 V	2.0	-	-	V
V _{IL}	LOW-level input voltage	V _{CC} = 0.8 V	-	-	0.30 × V _{CC}	V
		V _{CC} = 0.9 V to 1.95 V	-	-	0.35 × V _{CC}	V
		V _{CC} = 2.3 V to 2.7 V	-	-	0.7	V
		V _{CC} = 3.0 V to 3.6 V	-	-	0.9	V
V _{OL}	LOW-level output voltage	V _I = V _{IH} or V _{IL}				
		I _O = 20 μA; V _{CC} = 0.8 V to 3.6 V	-	-	0.1	V
		I _O = 1.1 mA; V _{CC} = 1.1 V	-	-	0.3 × V _{CC}	V
		I _O = 1.7 mA; V _{CC} = 1.4 V	-	-	0.37	V
		I _O = 1.9 mA; V _{CC} = 1.65 V	-	-	0.35	V
		I _O = 2.3 mA; V _{CC} = 2.3 V	-	-	0.33	V
		I _O = 3.1 mA; V _{CC} = 2.3 V	-	-	0.45	V
		I _O = 2.7 mA; V _{CC} = 3.0 V	-	-	0.33	V
I _O = 4.0 mA; V _{CC} = 3.0 V	-	-	0.45	V		
I _I	input leakage current	V _I = GND to 3.6 V; V _{CC} = 0 V to 3.6 V	-	-	±0.5	μA
I _{OZ}	OFF-state output current	V _I = V _{IH} or V _{IL} (and at least one input LOW); V _O = 0 V to 3.6 V; V _{CC} = 0 V to 3.6 V	-	-	±0.5	μA
I _{OFF}	power-off leakage current	V _I or V _O = 0 V to 3.6 V; V _{CC} = 0 V	-	-	±0.5	μA
ΔI _{OFF}	additional power-off leakage current	V _I or V _O = 0 V to 3.6 V; V _{CC} = 0 V to 0.2 V	-	-	±0.6	μA
I _{CC}	supply current	V _I = GND or V _{CC} ; I _O = 0 A; V _{CC} = 0.8 V to 3.6 V	-	-	0.9	μA
ΔI _{CC}	additional supply current	V _I = V _{CC} - 0.6 V; I _O = 0 A; V _{CC} = 3.3 V	-	-	50	μA

Low-power 2-input NAND gate (open drain)

Symbol	Parameter	Conditions	Min	Typ	Max	Unit
T_{amb} = -40 °C to +125 °C						
V _{IH}	HIGH-level input voltage	V _{CC} = 0.8 V	0.75 × V _{CC}	-	-	V
		V _{CC} = 0.9 V to 1.95 V	0.70 × V _{CC}	-	-	V
		V _{CC} = 2.3 V to 2.7 V	1.6	-	-	V
		V _{CC} = 3.0 V to 3.6 V	2.0	-	-	V
V _{IL}	LOW-level input voltage	V _{CC} = 0.8 V	-	-	0.25 × V _{CC}	V
		V _{CC} = 0.9 V to 1.95 V	-	-	0.30 × V _{CC}	V
		V _{CC} = 2.3 V to 2.7 V	-	-	0.7	V
		V _{CC} = 3.0 V to 3.6 V	-	-	0.9	V
V _{OL}	LOW-level output voltage	V _I = V _{IH} or V _{IL}				
		I _O = 20 μA; V _{CC} = 0.8 V to 3.6 V	-	-	0.11	V
		I _O = 1.1 mA; V _{CC} = 1.1 V	-	-	0.33 × V _{CC}	V
		I _O = 1.7 mA; V _{CC} = 1.4 V	-	-	0.41	V
		I _O = 1.9 mA; V _{CC} = 1.65 V	-	-	0.39	V
		I _O = 2.3 mA; V _{CC} = 2.3 V	-	-	0.36	V
		I _O = 3.1 mA; V _{CC} = 2.3 V	-	-	0.50	V
		I _O = 2.7 mA; V _{CC} = 3.0 V	-	-	0.36	V
I _O = 4.0 mA; V _{CC} = 3.0 V	-	-	0.50	V		
I _I	input leakage current	V _I = GND to 3.6 V; V _{CC} = 0 V to 3.6 V	-	-	±0.75	μA
I _{OZ}	OFF-state output current	V _I = V _{IH} or V _{IL} (and at least one input LOW); V _O = 0 V to 3.6 V; V _{CC} = 0 V to 3.6 V	-	-	±0.75	μA
I _{OFF}	power-off leakage current	V _I or V _O = 0 V to 3.6 V; V _{CC} = 0 V	-	-	±0.75	μA
ΔI _{OFF}	additional power-off leakage current	V _I or V _O = 0 V to 3.6 V; V _{CC} = 0 V to 0.2 V	-	-	±0.75	μA
I _{CC}	supply current	V _I = GND or V _{CC} ; I _O = 0 A; V _{CC} = 0.8 V to 3.6 V	-	-	1.4	μA
ΔI _{CC}	additional supply current	V _I = V _{CC} - 0.6 V; I _O = 0 A; V _{CC} = 3.3 V	-	-	75	μA

11. Dynamic characteristics

Table 8. Dynamic characteristics

Voltages are referenced to GND (ground = 0 V; for test circuit see Fig. 9).

Symbol	Parameter	Conditions	25 °C			-40 °C to +85 °C		-40 °C to +125 °C		Unit
			Min	Typ[1]	Max	Min	Max	Min	Max	
C_L = 5 pF										
t _{pd}	propagation delay	A or B to Y; see Fig. 8 [2]								
		V _{CC} = 0.8 V	-	13.5	-	-	-	-	-	ns
		V _{CC} = 1.1 V to 1.3 V	1.9	4.6	10.4	1.8	11.4	1.8	12.6	ns
		V _{CC} = 1.4 V to 1.6 V	1.5	3.3	6.5	1.4	7.4	1.4	8.2	ns
		V _{CC} = 1.65 V to 1.95 V	1.2	2.9	5.1	1.1	5.9	1.1	6.5	ns
		V _{CC} = 2.3 V to 2.7 V	1.0	2.2	3.8	0.9	4.5	0.9	4.9	ns
		V _{CC} = 3.0 V to 3.6 V	0.9	2.3	4.0	0.8	4.5	0.8	4.9	ns
C_L = 10 pF										
t _{pd}	propagation delay	A or B to Y; see Fig. 8 [2]								
		V _{CC} = 0.8 V	-	16.3	-	-	-	-	-	ns
		V _{CC} = 1.1 V to 1.3 V	2.3	5.6	12.3	2.1	13.7	2.1	15.1	ns
		V _{CC} = 1.4 V to 1.6 V	1.8	4.1	7.6	1.7	8.8	1.7	9.7	ns
		V _{CC} = 1.65 V to 1.95 V	1.6	3.8	6.1	1.4	7.1	1.4	7.8	ns
		V _{CC} = 2.3 V to 2.7 V	1.4	2.9	4.6	1.2	5.4	1.2	5.9	ns
		V _{CC} = 3.0 V to 3.6 V	1.3	3.2	5.7	1.1	6.4	1.1	7.0	ns
C_L = 15 pF										
t _{pd}	propagation delay	A or B to Y; see Fig. 8 [2]								
		V _{CC} = 0.8 V	-	19.0	-	-	-	-	-	ns
		V _{CC} = 1.1 V to 1.3 V	2.6	6.6	14.2	2.4	15.8	2.4	17.4	ns
		V _{CC} = 1.4 V to 1.6 V	2.1	4.8	8.7	1.9	10.1	1.9	11.1	ns
		V _{CC} = 1.65 V to 1.95 V	1.9	4.6	7.6	1.7	8.5	1.7	9.3	ns
		V _{CC} = 2.3 V to 2.7 V	1.6	3.6	5.6	1.5	6.3	1.5	6.9	ns
		V _{CC} = 3.0 V to 3.6 V	1.6	4.1	7.5	1.4	8.3	1.4	9.1	ns
C_L = 30 pF										
t _{pd}	propagation delay	A or B to Y; see Fig. 8 [2]								
		V _{CC} = 0.8 V	-	27.0	-	-	-	-	-	ns
		V _{CC} = 1.1 V to 1.3 V	3.6	9.5	19.5	3.2	21.8	3.2	24.0	ns
		V _{CC} = 1.4 V to 1.6 V	2.9	7.0	11.5	2.6	13.6	2.6	15.0	ns
		V _{CC} = 1.65 V to 1.95 V	2.6	7.0	12.1	2.3	13.3	2.3	14.6	ns
		V _{CC} = 2.3 V to 2.7 V	2.4	5.4	8.9	2.1	9.9	2.1	10.9	ns
		V _{CC} = 3.0 V to 3.6 V	2.3	6.5	12.7	2.1	13.9	2.1	15.3	ns

Symbol	Parameter	Conditions	25 °C			-40 °C to +85 °C		-40 °C to +125 °C		Unit
			Min	Typ[1]	Max	Min	Max	Min	Max	
C_L = 5 pF, 10 pF, 15 pF and 30 pF										
C _{PD}	power dissipation capacitance	f _i = 1 MHz; V _I = GND to V _{CC} [3]								
		V _{CC} = 0.8 V	-	0.6	-	-	-	-	-	pF
		V _{CC} = 1.1 V to 1.3 V	-	0.7	-	-	-	-	-	pF
		V _{CC} = 1.4 V to 1.6 V	-	0.8	-	-	-	-	-	pF
		V _{CC} = 1.65 V to 1.95 V	-	0.9	-	-	-	-	-	pF
		V _{CC} = 2.3 V to 2.7 V	-	1.1	-	-	-	-	-	pF
		V _{CC} = 3.0 V to 3.6 V	-	1.4	-	-	-	-	-	pF

- [1] All typical values are measured at nominal V_{CC}.
- [2] t_{pd} is the same as t_{PZL} and t_{PLZ}.
- [3] C_{PD} is used to determine the dynamic power dissipation (P_D in μW).
 $P_D = C_{PD} \times V_{CC}^2 \times f_i \times N$ where:
 f_i = input frequency in MHz;
 V_{CC} = supply voltage in V;
 N = number of inputs switching.

11.1. Waveforms and test circuit

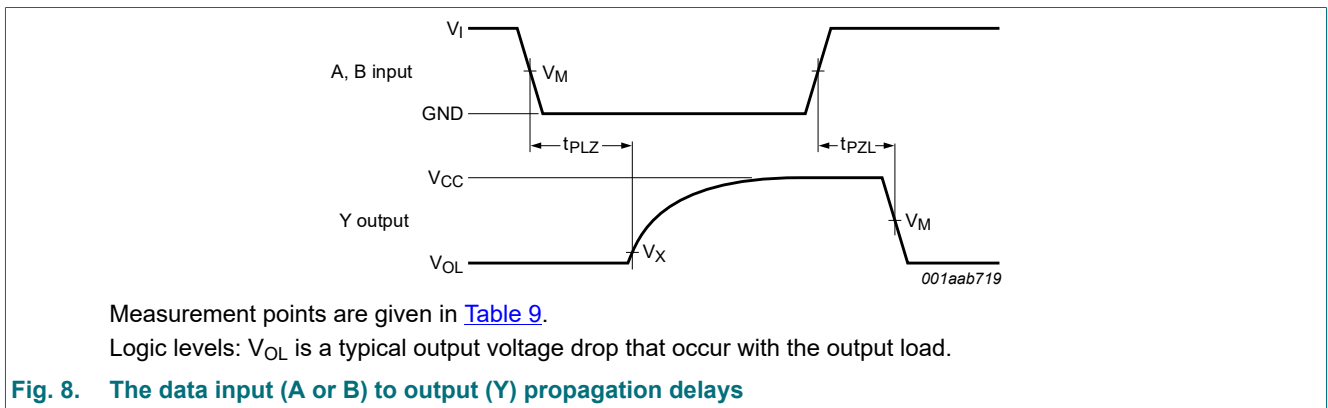

Fig. 8. The data input (A or B) to output (Y) propagation delays

Table 9. Measurement points

Supply voltage	Input			Output	
V _{CC}	V _M	V _I	t _r = t _f	V _M	V _X
0.8 V to 1.6 V	0.5 × V _{CC}	V _{CC}	≤ 3.0 ns	0.5 × V _{CC}	V _{OL} + 0.1 V
1.65 V to 2.7 V	0.5 × V _{CC}	V _{CC}	≤ 3.0 ns	0.5 × V _{CC}	V _{OL} + 0.15 V
3.0 V to 3.6 V	0.5 × V _{CC}	V _{CC}	≤ 3.0 ns	0.5 × V _{CC}	V _{OL} + 0.3 V

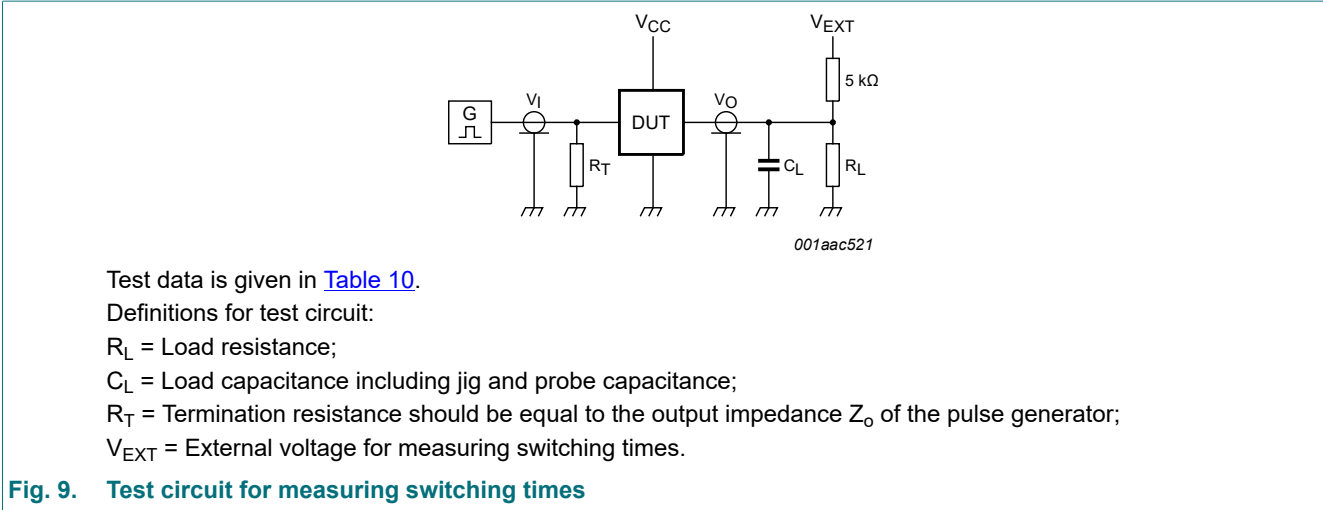

Table 10. Test data

Supply voltage		Load		V_{EXT}		
V_{CC}	C_L	R_L [1]	t_{PLH}, t_{PHL}	t_{PZH}, t_{PHZ}	t_{PZL}, t_{PLZ}	
0.8 V to 3.6 V	5 pF, 10 pF, 15 pF and 30 pF	5 kΩ or 1 MΩ	open	GND	$2 \times V_{CC}$	

[1] For measuring enable and disable times $R_L = 5 \text{ k}\Omega$.
 For measuring propagation delays, setup and hold times and pulse width $R_L = 1 \text{ M}\Omega$.

12. Package outline

TSSOP5: plastic thin shrink small outline package; 5 leads; body width 1.25 mm

SOT353-1



Fig. 10. Package outline SOT353-1 (TSSOP5)

XSON6: plastic extremely thin small outline package; no leads; 6 terminals; body 1 x 1.45 x 0.5 mm

SOT886



Fig. 11. Package outline SOT886 (XSON6)

XSON6: extremely thin small outline package; no leads;
6 terminals; body 0.9 x 1.0 x 0.35 mm

SOT1115



Fig. 12. Package outline SOT1115 (XSON6)

XSON6: extremely thin small outline package; no leads;
6 terminals; body 1.0 x 1.0 x 0.35 mm

SOT1202



Fig. 13. Package outline SOT1202 (XSON6)

X2SON5: plastic thermal enhanced extremely thin small outline package; no leads;
5 terminals; body 0.8 x 0.8 x 0.32 mm

SOT1226-3



Fig. 14. Package outline SOT1226-3 (X2SON5)

13. Abbreviations

Table 11. Abbreviations

Acronym	Description
CDM	Charged Device Model
DUT	Device Under Test
ESD	ElectroStatic Discharge
HBM	Human Body Model
MM	Machine Model

14. Revision history

Table 12. Revision history

Document ID	Release date	Data sheet status	Change notice	Supersedes
74AUP1G38 v.9	20220816	Product data sheet	-	74AUP1G38 v.8
Modifications:	<ul style="list-style-type: none"> Package SOT1226 (X2SON5) changed to SOT1226-3 (X2SON5). 			
74AUP1G38 v.8	20220207	Product data sheet	-	74AUP1G38 v.7
Modifications:	<ul style="list-style-type: none"> The format of this data sheet has been redesigned to comply with the identity guidelines of Nexperia. Legal texts have been adapted to the new company name where appropriate. Fig. 10: Package outline drawing for SOT353-1 (TSSOP5) has changed. Type number 74AUP1G38GF (SOT891/ XSON6) removed. Section 1 and Section 2 updated. Table 5: Derating values for P_{tot} total power dissipation updated. 			
74AUP1G38 v.7	20160404	Product data sheet	-	74AUP1G38 v.6
Modifications:	<ul style="list-style-type: none"> Fig. 7: Typo corrected in pin naming (pins A and B swapped) 			
74AUP1G38 v.6	20120628	Product data sheet	-	74AUP1G38 v.5
Modifications:	<ul style="list-style-type: none"> Added type number 74AUP1G38GX (SOT1226) Package outline drawing of SOT886 (Fig. 11) modified. 			
74AUP1G38 v.5	20111129	Product data sheet	-	74AUP1G38 v.4
Modifications:	<ul style="list-style-type: none"> Legal pages updated. 			
74AUP1G38 v.4	20101007	Product data sheet	-	74AUP1G38 v.3
74AUP1G38 v.3	20090622	Product data sheet	-	74AUP1G38 v.2
74AUP1G38 v.2	20070614	Product data sheet	-	74AUP1G38 v.1
74AUP1G38 v.1	20061020	Product data sheet	-	-

15. Legal information

Data sheet status

Document status [1][2]	Product status [3]	Definition
Objective [short] data sheet	Development	This document contains data from the objective specification for product development.
Preliminary [short] data sheet	Qualification	This document contains data from the preliminary specification.
Product [short] data sheet	Production	This document contains the product specification.

- [1] Please consult the most recently issued document before initiating or completing a design.
- [2] The term 'short data sheet' is explained in section "Definitions".
- [3] The product status of device(s) described in this document may have changed since this document was published and may differ in case of multiple devices. The latest product status information is available on the internet at <https://www.nexperia.com>.

Definitions

Draft — The document is a draft version only. The content is still under internal review and subject to formal approval, which may result in modifications or additions. Nexperia does not give any representations or warranties as to the accuracy or completeness of information included herein and shall have no liability for the consequences of use of such information.

Short data sheet — A short data sheet is an extract from a full data sheet with the same product type number(s) and title. A short data sheet is intended for quick reference only and should not be relied upon to contain detailed and full information. For detailed and full information see the relevant full data sheet, which is available on request via the local Nexperia sales office. In case of any inconsistency or conflict with the short data sheet, the full data sheet shall prevail.

Product specification — The information and data provided in a Product data sheet shall define the specification of the product as agreed between Nexperia and its customer, unless Nexperia and customer have explicitly agreed otherwise in writing. In no event however, shall an agreement be valid in which the Nexperia product is deemed to offer functions and qualities beyond those described in the Product data sheet.

Disclaimers

Limited warranty and liability — Information in this document is believed to be accurate and reliable. However, Nexperia does not give any representations or warranties, expressed or implied, as to the accuracy or completeness of such information and shall have no liability for the consequences of use of such information. Nexperia takes no responsibility for the content in this document if provided by an information source outside of Nexperia.

In no event shall Nexperia be liable for any indirect, incidental, punitive, special or consequential damages (including - without limitation - lost profits, lost savings, business interruption, costs related to the removal or replacement of any products or rework charges) whether or not such damages are based on tort (including negligence), warranty, breach of contract or any other legal theory.

Notwithstanding any damages that customer might incur for any reason whatsoever, Nexperia's aggregate and cumulative liability towards customer for the products described herein shall be limited in accordance with the Terms and conditions of commercial sale of Nexperia.

Right to make changes — Nexperia reserves the right to make changes to information published in this document, including without limitation specifications and product descriptions, at any time and without notice. This document supersedes and replaces all information supplied prior to the publication hereof.

Suitability for use — Nexperia products are not designed, authorized or warranted to be suitable for use in life support, life-critical or safety-critical systems or equipment, nor in applications where failure or malfunction of an Nexperia product can reasonably be expected to result in personal

injury, death or severe property or environmental damage. Nexperia and its suppliers accept no liability for inclusion and/or use of Nexperia products in such equipment or applications and therefore such inclusion and/or use is at the customer's own risk.

Quick reference data — The Quick reference data is an extract of the product data given in the Limiting values and Characteristics sections of this document, and as such is not complete, exhaustive or legally binding.

Applications — Applications that are described herein for any of these products are for illustrative purposes only. Nexperia makes no representation or warranty that such applications will be suitable for the specified use without further testing or modification.

Customers are responsible for the design and operation of their applications and products using Nexperia products, and Nexperia accepts no liability for any assistance with applications or customer product design. It is customer's sole responsibility to determine whether the Nexperia product is suitable and fit for the customer's applications and products planned, as well as for the planned application and use of customer's third party customer(s). Customers should provide appropriate design and operating safeguards to minimize the risks associated with their applications and products.

Nexperia does not accept any liability related to any default, damage, costs or problem which is based on any weakness or default in the customer's applications or products, or the application or use by customer's third party customer(s). Customer is responsible for doing all necessary testing for the customer's applications and products using Nexperia products in order to avoid a default of the applications and the products or of the application or use by customer's third party customer(s). Nexperia does not accept any liability in this respect.

Limiting values — Stress above one or more limiting values (as defined in the Absolute Maximum Ratings System of IEC 60134) will cause permanent damage to the device. Limiting values are stress ratings only and (proper) operation of the device at these or any other conditions above those given in the Recommended operating conditions section (if present) or the Characteristics sections of this document is not warranted. Constant or repeated exposure to limiting values will permanently and irreversibly affect the quality and reliability of the device.

Terms and conditions of commercial sale — Nexperia products are sold subject to the general terms and conditions of commercial sale, as published at <http://www.nexperia.com/profile/terms>, unless otherwise agreed in a valid written individual agreement. In case an individual agreement is concluded only the terms and conditions of the respective agreement shall apply. Nexperia hereby expressly objects to applying the customer's general terms and conditions with regard to the purchase of Nexperia products by customer.

No offer to sell or license — Nothing in this document may be interpreted or construed as an offer to sell products that is open for acceptance or the grant, conveyance or implication of any license under any copyrights, patents or other industrial or intellectual property rights.

Export control — This document as well as the item(s) described herein may be subject to export control regulations. Export might require a prior authorization from competent authorities.

Non-automotive qualified products — Unless this data sheet expressly states that this specific Nexperia product is automotive qualified, the product is not suitable for automotive use. It is neither qualified nor tested in accordance with automotive testing or application requirements. Nexperia accepts no liability for inclusion and/or use of non-automotive qualified products in automotive equipment or applications.

In the event that customer uses the product for design-in and use in automotive applications to automotive specifications and standards, customer (a) shall use the product without Nexperia's warranty of the product for such automotive applications, use and specifications, and (b) whenever customer uses the product for automotive applications beyond Nexperia's specifications such use shall be solely at customer's own risk, and (c) customer fully indemnifies Nexperia for any liability, damages or failed product claims resulting from customer design and use of the product for automotive applications beyond Nexperia's standard warranty and Nexperia's product specifications.

Translations — A non-English (translated) version of a document is for reference only. The English version shall prevail in case of any discrepancy between the translated and English versions.

Trademarks

Notice: All referenced brands, product names, service names and trademarks are the property of their respective owners.

Contents

1. General description	1
2. Features and benefits	1
3. Ordering information	2
4. Marking	2
5. Functional diagram	2
6. Pinning information	3
6.1. Pinning.....	3
6.2. Pin description.....	3
7. Functional description	4
8. Limiting values	4
9. Recommended operating conditions	4
10. Static characteristics	5
11. Dynamic characteristics	8
11.1. Waveforms and test circuit.....	9
12. Package outline	11
13. Abbreviations	16
14. Revision history	16
15. Legal information	17

© Nexperia B.V. 2022. All rights reserved

For more information, please visit: <http://www.nexperia.com>

For sales office addresses, please send an email to: salesaddresses@nexperia.com

Date of release: 16 August 2022
