

MOSFET – N-Channel, Field Effect Transistor, Enhancement Mode

NDP6060 / NDB6060

General Description

These N-Channel enhancement mode power field effect transistors are produced using onsemi's proprietary, high cell density, DMOS technology. This very high density process has been especially tailored to minimize on-state resistance, provide superior switching performance, and withstand high energy pulses in the avalanche and commutation modes. These devices are particularly suited for low voltage applications such as automotive, DC/DC converters, PWM motor controls, and other battery powered circuits where fast switching, low in-line power loss, and resistance to transients are needed.

Features

- 48 A, 60 V
 - ◆ $R_{DS(ON)} = 0.025 \text{ m}\Omega @ V_{GS} = 10 \text{ V}$
- Critical DC Electrical Parameters Specified at Elevated Temperature
- Rugged Internal Source-Drain Diode Can Eliminate the Need for an External Zener Diode Transient Suppressor
- 175°C Maximum Junction Temperature Rating
- High Density Cell Design for Extremely Low $R_{DS(ON)}$
- TO-220 Package for Both Through Hole and Surface Mount Applications
- This is a Halide Free Device

MAXIMUM RATINGS ($T_C = 25^\circ\text{C}$ unless otherwise noted)

Symbol	Rating	NDP6060	Unit
V_{DSS}	Drain-Source Voltage	60	V
V_{DGR}	Drain-Gate Voltage ($R_{GS} \leq 1 \text{ M}\Omega$)	60	V
V_{GSS}	Drain-Source Voltage - Continuous - Nonrepetiti ($t_p < 50 \mu\text{s}$)	± 20 ± 40	V
I_D	Drain Current - Continuous $T_C = 25^\circ\text{C}$ - Continuous $T_C = 100^\circ\text{C}$ - Pulsed	48 32 144	A
P_D	Total Power Dissipation @ $T_C = 25^\circ\text{C}$ - Derate above 25°C	100 0.67	W W/°C
T_J, T_{STG}	Operating and Storage Temperature Range	-65 to 175	°C
T_L	Maximum lead temperature for soldering purposes, 1/8" from case for 5 seconds	275	°C

Stresses exceeding those listed in the Maximum Ratings table may damage the device. If any of these limits are exceeded, device functionality should not be assumed, damage may occur and reliability may be affected.

V_{DSS}	$R_{DS(ON)} \text{ MAX}$	$I_D \text{ MAX}$
60 V	0.025 m Ω @ 10 V	48 A

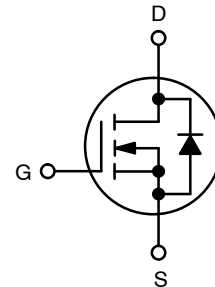

N-CHANNEL MOSFET

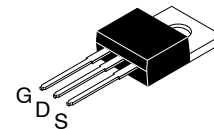

TO-220-3LD
CASE 340AT

MARKING DIAGRAM

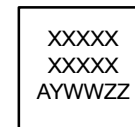

XXXX = Specific Device Code
A = Assembly Location
Y = Year
WW = Work Week
ZZ = Assembly Lot Code

ORDERING INFORMATION

Device	Package	Shipping [†]
NDP6060	TO-220-3LD (Halide Free)	800 / Units / Tube

[†]For information on tape and reel specifications, including part orientation and tape sizes, please refer to our Tape and Reel Packaging Specification Brochure, [BRD8011/D](#).

NDP6060 / NDB6060

ELECTRICAL CHARACTERISTICS (T_J = 25°C unless otherwise specified)

Symbol	Parameter	Condition	Min	Typ	Max	Unit
--------	-----------	-----------	-----	-----	-----	------

DRAIN-SOURCE AVALANCHE RATINGS (Note 1)

W _{DSS}	Single Pulse Drain-Source Avalanche Energy	V _{DD} = 25 V, I _D = 48 A	-	-	200	mJ
I _{AR}	Maximum Drain-Source Avalanche Current		-	-	48	A

OFF CHARACTERISTICS

BV _{DSS}	Drain-Source Breakdown Voltage	V _{GS} = 0 V, I _D = 250 μA	60	-	-	V
I _{DSS}	Zero Gate Voltage Drain Current	V _{DS} = 60 V, V _{GS} = 0 V	-	-	250	μA
		T _J = 125°C	-	-	1	mA
I _{GSSF}	Gate-Body Leakage, Forward	V _{GS} = 20 V, V _{DS} = 0 V	-	-	100	nA
I _{GSSR}	Gate-Body Leakage, Reverse	V _{GS} = -20 V, V _{DS} = 0 V	-	-	-100	nA

ON CHARACTERISTICS (Note 1)

V _{GS(th)}	Gate Threshold Voltage	V _{DS} = V _{GS} , I _D = 250 μA	2	2.9	4	V
		T _J = 125°C	1.4	2.3	3.6	
R _{DS(on)}	Static Drain-Source On-Resistance	V _{GS} = 10 V, I _D = 24 A	-	0.02	0.025	W
		T _J = 125°C	-	0.032	0.04	
I _{D(on)}	On-State Drain Current	V _{GS} = 10 V, V _{DS} = 10 V	48	-	-	A
g _{FS}	Forward Transconductance	V _{DS} = 10 V, I _D = 24 A	10	19	-	S

DYNAMIC CHARACTERISTICS

C _{iss}	Input Capacitance	V _{DS} = 25 V, V _{GS} = 0 V, f = 1.0 MHz	-	1190	1800	pF
C _{oss}	Output Capacitance		-	475	800	pF
C _{rss}	Reverse Transfer Capacitance		-	150	400	pF

SWITCHING CHARACTERISTICS (Note 1)

t _{D(on)}	Turn - On Delay Time	V _{DD} = 30 V, I _D = 48 A, V _{GS} = 10 V, R _{GEN} = 7.5 W	-	10	20	nS
t _r	Turn - On Rise Time		-	145	300	nS
t _{D(off)}	Turn - Off Delay Time		-	28	60	nS
t _f	Turn - Off Fall Time		-	77	150	nS
Q _g	Total Gate Charge	V _{DS} = 48 V, I _D = 48 A, V _{GS} = 10V	-	39	70	nC
Q _{gs}	Gate-Source Charge		-	7.6	-	nC
Q _{gd}	Gate-Drain Charge		-	22	-	nC

DRAIN-SOURCE DIODE CHARACTERISTICS

I _S	Maximum Continuous Drain-Source Diode Forward Current		-	-	48	A
I _{SM}	Maximum Pulsed Drain-Source Diode Forward Current		-	-	144	A
V _{SD}	Drain-Source Diode Forward Voltage	V _{GS} = 0 V, I _S = 24 A (Note 1)	-	0.9	1.3	V
		T _J = 125°C	-	0.8	1.2	
t _{rr}	Reverse Recovery Time	V _{GS} = 0 V, I _F = 48 A,	35	87	140	ns
I _{rr}	Reverse Recovery Current	dI _F /dt = 100 A/μs	2	3.6	8	A

THERMAL CHARACTERISTICS

R _{θJC}	Thermal Resistance, Junction-to-Case		-	-	1.5	°C/W
R _{θJA}	Thermal Resistance, Junction-to-Ambient		-	-	62.5	°C/W

Product parametric performance is indicated in the Electrical Characteristics for the listed test conditions, unless otherwise noted. Product performance may not be indicated by the Electrical Characteristics if operated under different conditions.

1. Pulse Test: pulse width ≤ 300 μs, duty cycle ≤ 2%.

TYPICAL CHARACTERISTICS

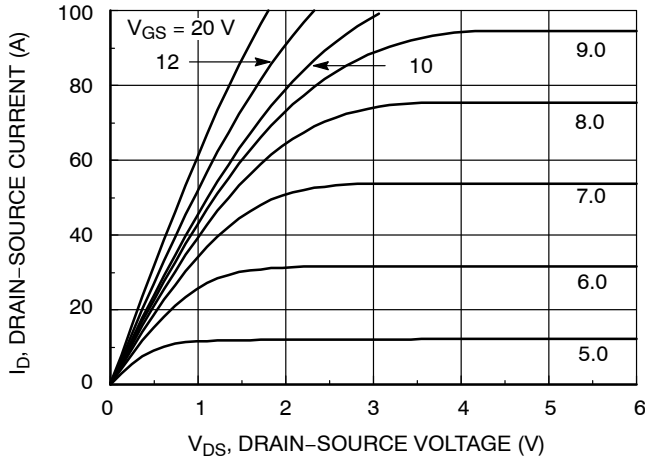

Figure 1. On-Region Characteristics

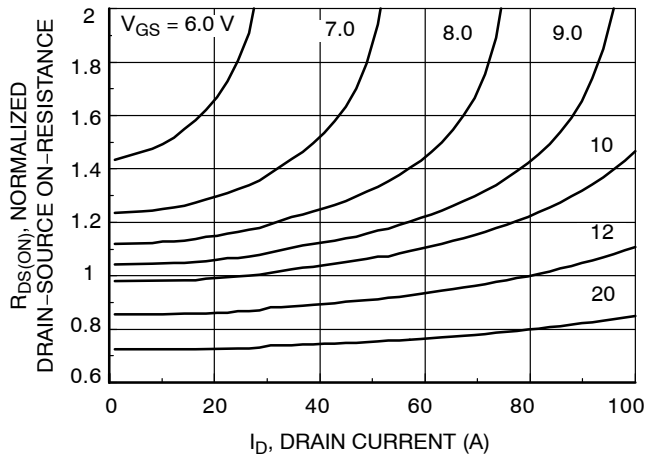

Figure 2. On-Resistance Variation with Gate Voltage and Drain Current

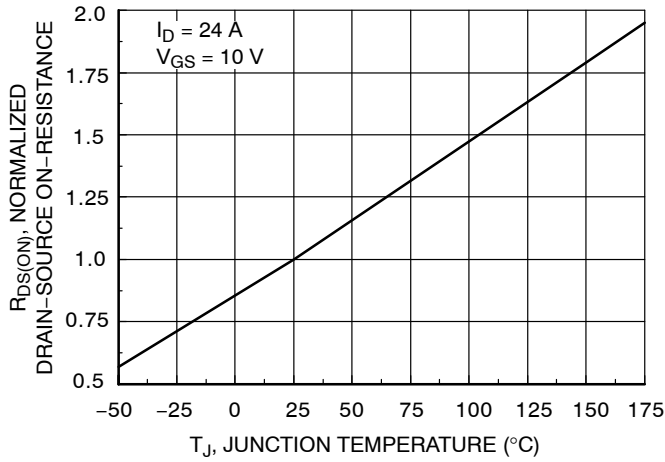

Figure 3. On-Resistance Variation with Temperature

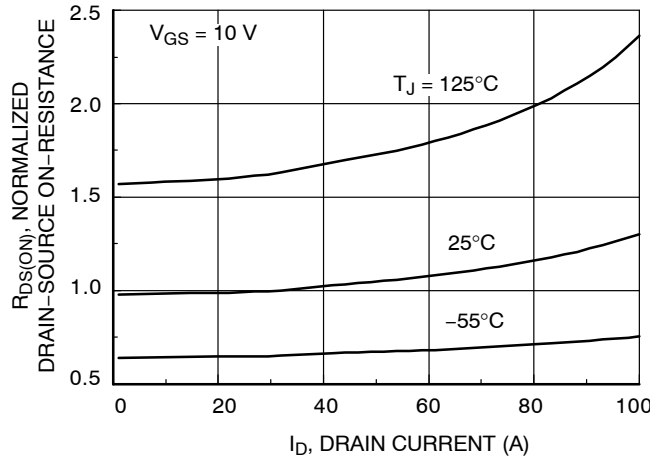

Figure 4. On-Resistance Variation with Drain Current and Temperature

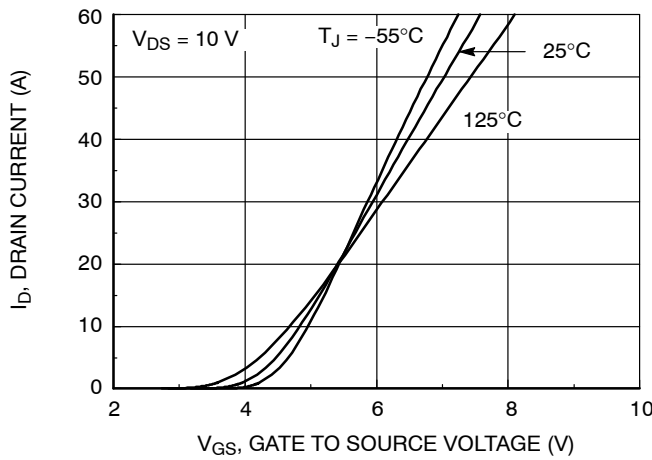

Figure 5. Transfer Characteristics

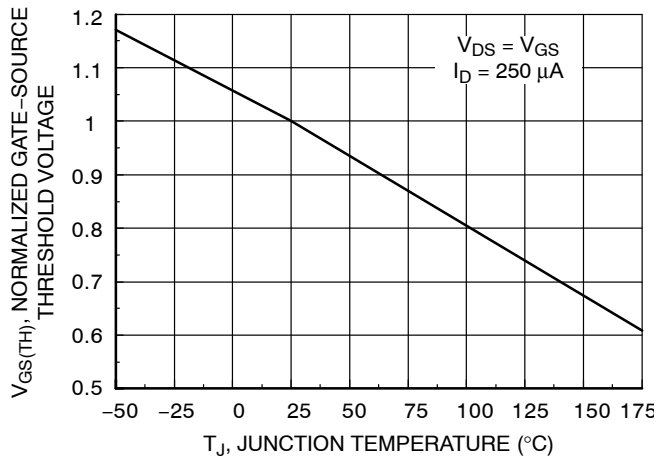

Figure 6. Gate Threshold Variation with Temperature

TYPICAL CHARACTERISTICS (continued)

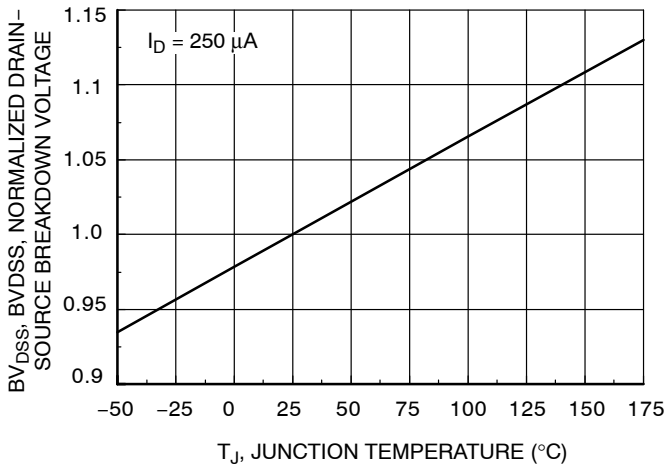

Figure 7. Breakdown Voltage Variation with Temperature

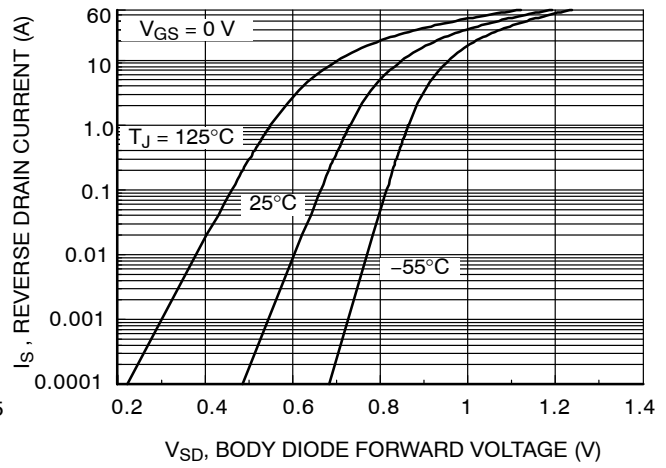

Figure 8. Body Diode Forward Voltage Variation with Current and Temperature

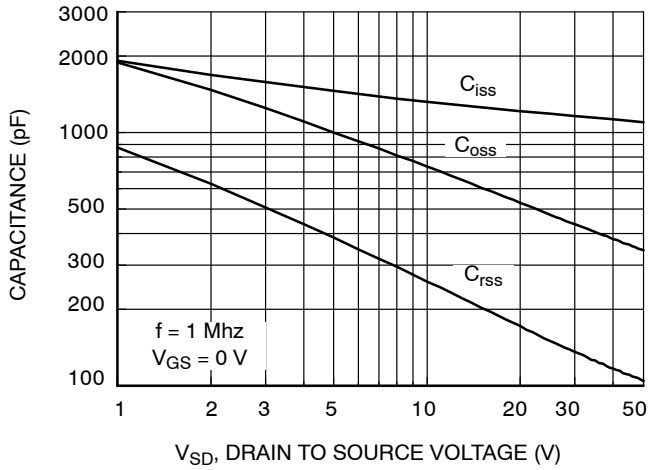

Figure 9. Capacitance Characteristics

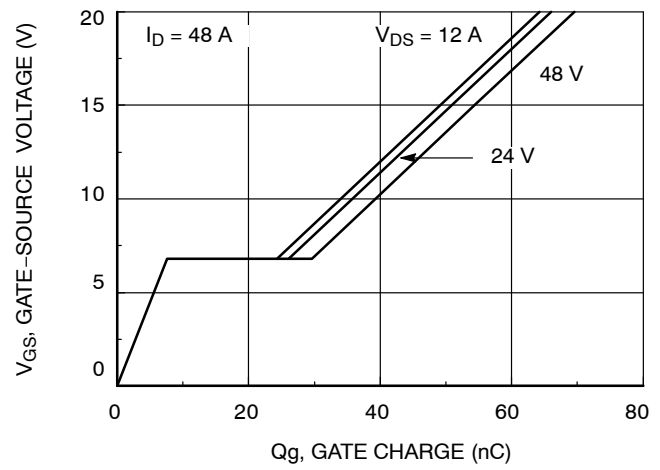

Figure 10. Gate Charge Characteristics

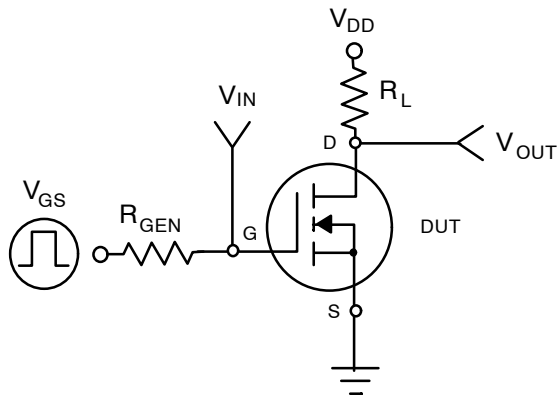

Figure 11. Switching Test Circuit

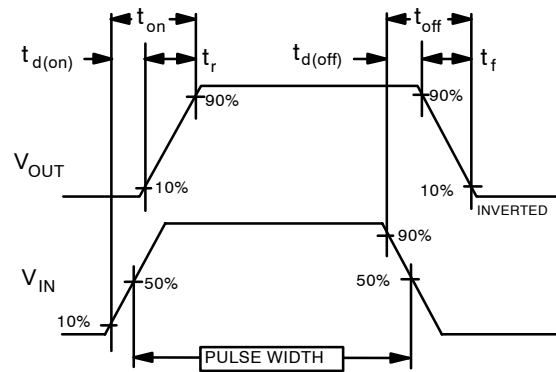

Figure 12. Switching Waveforms

TYPICAL CHARACTERISTICS

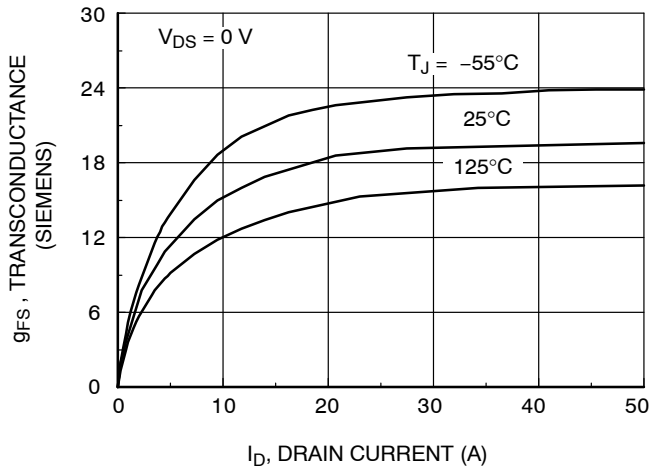

Figure 13. Transconductance Variation with Drain Current and Temperature

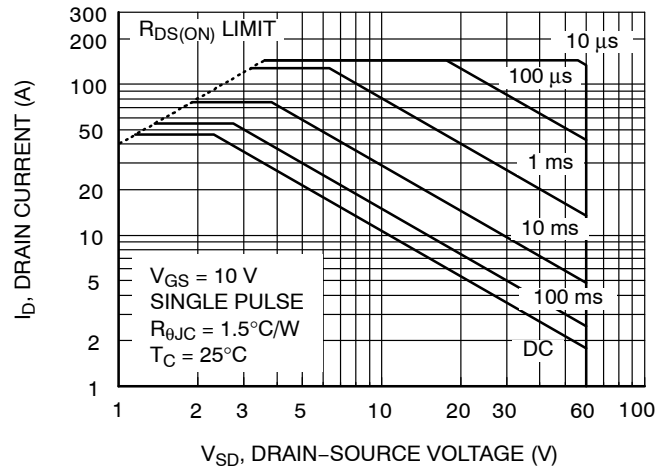

Figure 14. Maximum Safe Operating Area

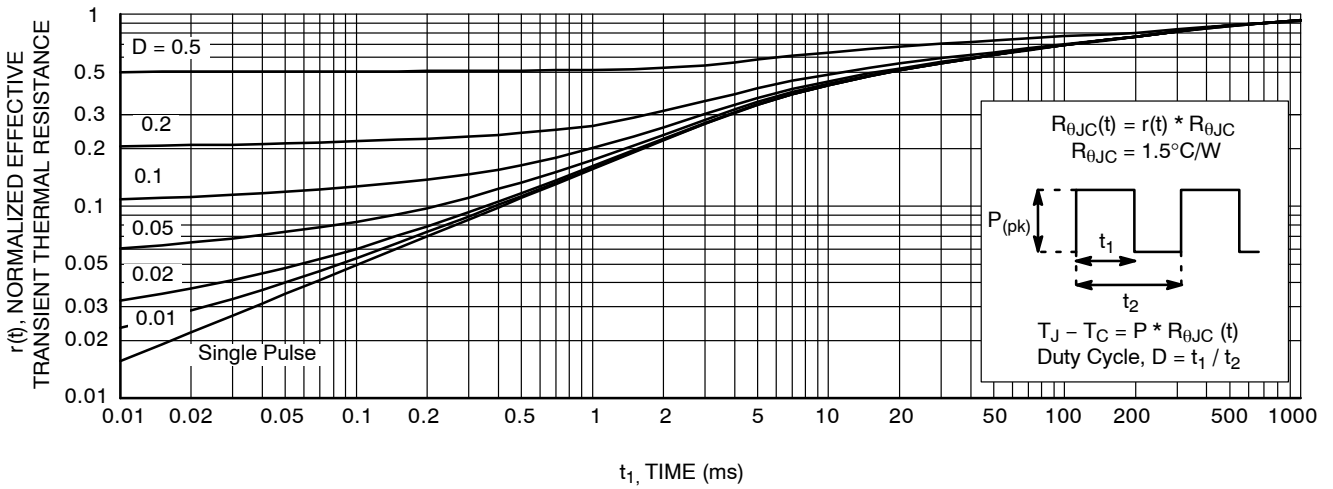
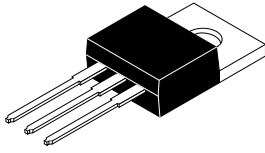

Figure 15. Transient Thermal Response Curve

MECHANICAL CASE OUTLINE

PACKAGE DIMENSIONS

ON Semiconductor®



Scale 1:1

TO-220-3LD CASE 340AT ISSUE A

DATE 03 OCT 2017

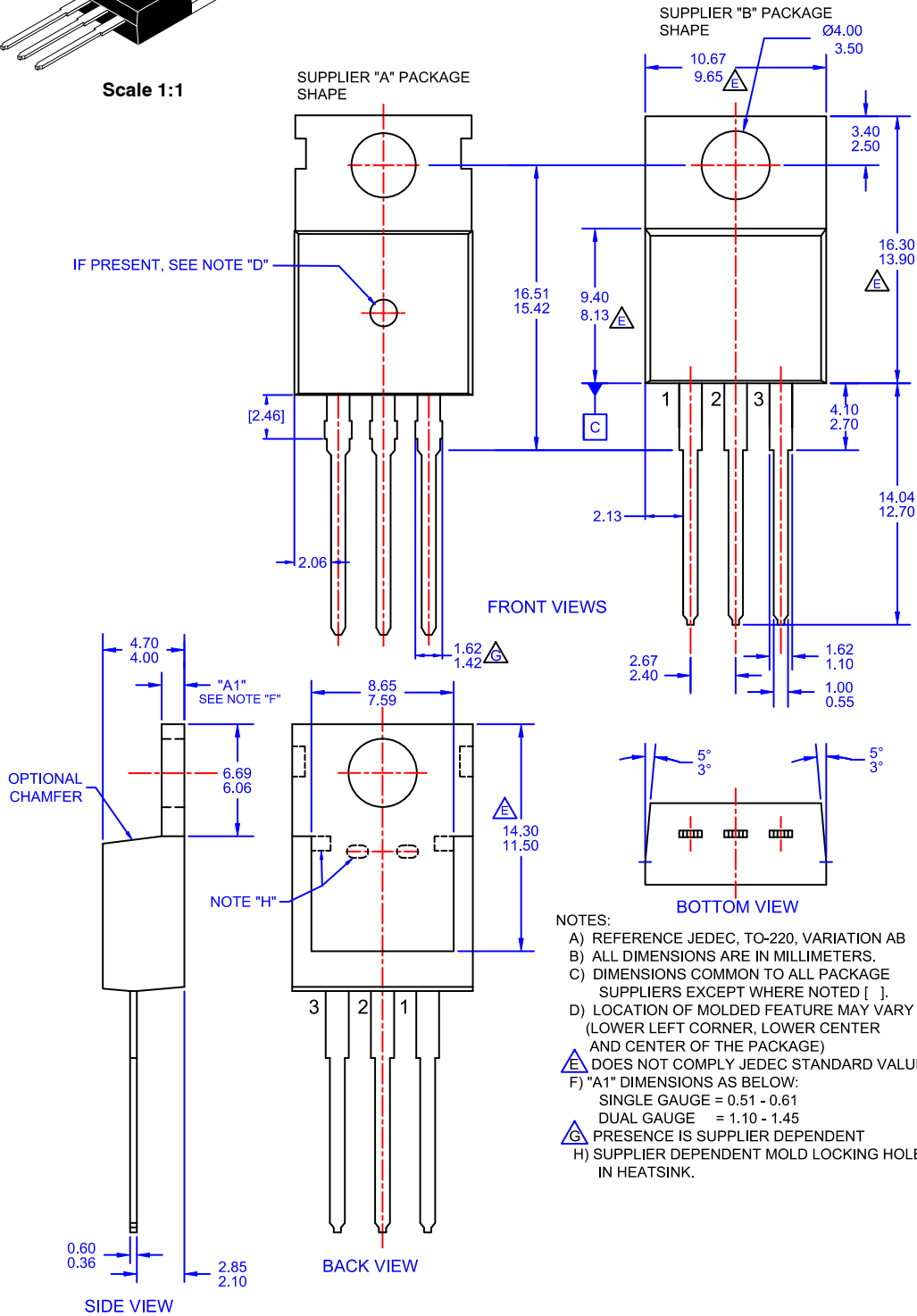

- NOTES:
- A) REFERENCE JEDEC, TO-220, VARIATION AB
 - B) ALL DIMENSIONS ARE IN MILLIMETERS.
 - C) DIMENSIONS COMMON TO ALL PACKAGE SUPPLIERS EXCEPT WHERE NOTED [].
 - D) LOCATION OF MOLDED FEATURE MAY VARY (LOWER LEFT CORNER, LOWER CENTER AND CENTER OF THE PACKAGE)
 - E) DOES NOT COMPLY JEDEC STANDARD VALUE.
 - F) "A1" DIMENSIONS AS BELOW:
 SINGLE GAUGE = 0.51 - 0.61
 DUAL GAUGE = 1.10 - 1.45
 - G) PRESENCE IS SUPPLIER DEPENDENT
 - H) SUPPLIER DEPENDENT MOLD LOCKING HOLES IN HEATSINK.

DOCUMENT NUMBER:	98AON13818G	Electronic versions are uncontrolled except when accessed directly from the Document Repository. Printed versions are uncontrolled except when stamped "CONTROLLED COPY" in red.
DESCRIPTION:	TO-220-3LD	PAGE 1 OF 1

ON Semiconductor and are trademarks of Semiconductor Components Industries, LLC dba ON Semiconductor or its subsidiaries in the United States and/or other countries. ON Semiconductor reserves the right to make changes without further notice to any products herein. ON Semiconductor makes no warranty, representation or guarantee regarding the suitability of its products for any particular purpose, nor does ON Semiconductor assume any liability arising out of the application or use of any product or circuit, and specifically disclaims any and all liability, including without limitation special, consequential or incidental damages. ON Semiconductor does not convey any license under its patent rights nor the rights of others.

onsemi, **Onsemi**, and other names, marks, and brands are registered and/or common law trademarks of Semiconductor Components Industries, LLC dba "**onsemi**" or its affiliates and/or subsidiaries in the United States and/or other countries. **onsemi** owns the rights to a number of patents, trademarks, copyrights, trade secrets, and other intellectual property. A listing of **onsemi**'s product/patent coverage may be accessed at www.onsemi.com/site/pdf/Patent-Marking.pdf. **onsemi** reserves the right to make changes at any time to any products or information herein, without notice. The information herein is provided "as-is" and **onsemi** makes no warranty, representation or guarantee regarding the accuracy of the information, product features, availability, functionality, or suitability of its products for any particular purpose, nor does **onsemi** assume any liability arising out of the application or use of any product or circuit, and specifically disclaims any and all liability, including without limitation special, consequential or incidental damages. Buyer is responsible for its products and applications using **onsemi** products, including compliance with all laws, regulations and safety requirements or standards, regardless of any support or applications information provided by **onsemi**. "Typical" parameters which may be provided in **onsemi** data sheets and/or specifications can and do vary in different applications and actual performance may vary over time. All operating parameters, including "Typicals" must be validated for each customer application by customer's technical experts. **onsemi** does not convey any license under any of its intellectual property rights nor the rights of others. **onsemi** products are not designed, intended, or authorized for use as a critical component in life support systems or any FDA Class 3 medical devices or medical devices with a same or similar classification in a foreign jurisdiction or any devices intended for implantation in the human body. Should Buyer purchase or use **onsemi** products for any such unintended or unauthorized application, Buyer shall indemnify and hold **onsemi** and its officers, employees, subsidiaries, affiliates, and distributors harmless against all claims, costs, damages, and expenses, and reasonable attorney fees arising out of, directly or indirectly, any claim of personal injury or death associated with such unintended or unauthorized use, even if such claim alleges that **onsemi** was negligent regarding the design or manufacture of the part. **onsemi** is an Equal Opportunity/Affirmative Action Employer. This literature is subject to all applicable copyright laws and is not for resale in any manner.

PUBLICATION ORDERING INFORMATION

LITERATURE FULFILLMENT:

Email Requests to: orderlit@onsemi.com

onsemi Website: www.onsemi.com

TECHNICAL SUPPORT

North American Technical Support:

Voice Mail: 1 800-282-9855 Toll Free USA/Canada

Phone: 011 421 33 790 2910

Europe, Middle East and Africa Technical Support:

Phone: 00421 33 790 2910

For additional information, please contact your local Sales Representative