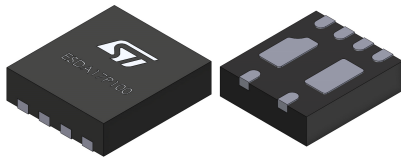


## High power transient voltage suppressor



μQFN package

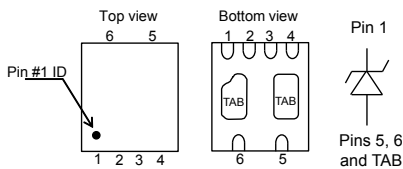
### Features

- Low clamping voltage
- Peak pulse power: 4800 W (8/20 μs)
- Stand-off voltage 15 V
- Unidirectional diode
- Low leakage current: 0.2 μA at 25 °C
- Complies with IEC 61000-4-2 level 4
  - ±30 kV (air discharge)
  - ±30 kV (contact discharge)

### Applications

Where transient overvoltage protection in ESD sensitive equipment is required, such as:

- Smartphones, mobile phones, tablets, portable multimedia
- USB V<sub>BUS</sub> protection
- Power supply protection
- Battery protection



Pin	Name	Description
1	V <sub>BUS</sub>	V <sub>BUS</sub> pin
2, 3, 4	NC	Non connected pin
5, 6	GND	Ground pin
TAB	GND	Ground pin

### Description

The ESDA17P100-1U2M is a unidirectional single line TVS diode designed to protect the power line against EOS and ESD transients.

The device is ideal for applications where high power TVS and board space saving is required.

#### Product status link

[ESDA17P100-1U2M](#)

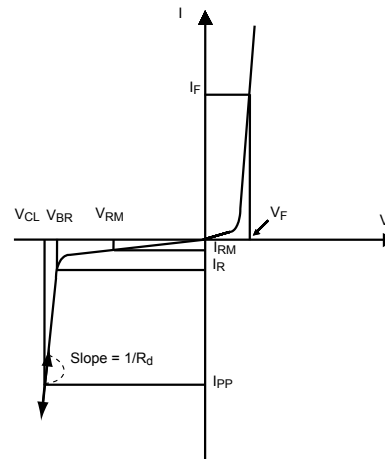
# 1 ESDA17P100-1U2M\_Characteristics

**Table 1. Absolute maximum ratings ( $T_{amb} = 25\text{ }^{\circ}\text{C}$ )**

Symbol	Parameter	Value	Unit	
$V_{PP}$	Peak pulse voltage	IEC 61000-4-2: Contact discharge	>30	kV
		Air discharge	>30	
$P_{PP}$	Peak pulse power	8/20 $\mu$ s	4800	W
$I_{PP}$	Peak pulse current	8/20 $\mu$ s	160	A
$T_{stg}$	Storage junction temperature range		-55 to + 150	$^{\circ}\text{C}$
$T_{op}$	Operating junction temperature range		-55 to + 150	$^{\circ}\text{C}$

**Figure 1. Electrical characteristics (definitions)**

- Symbol      Parameter  
 $V_{BR}$       = Breakdown voltage at  $I_R$   
 $V_{CL}$       = Clamping voltage  
 $I_{RM}$       = Leakage current at  $V_{RM}$   
 $V_{RM}$       = Stand-off voltage  
 $I_{PP}$       = Peak pulse current at  $V_{CL}$   
 $R_d$         = Dynamic resistance

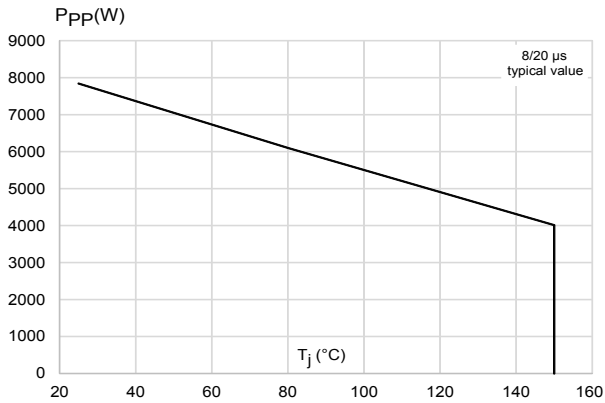


**Table 2. Electrical characteristics ( $T_{amb} = 25\text{ }^{\circ}\text{C}$ )**

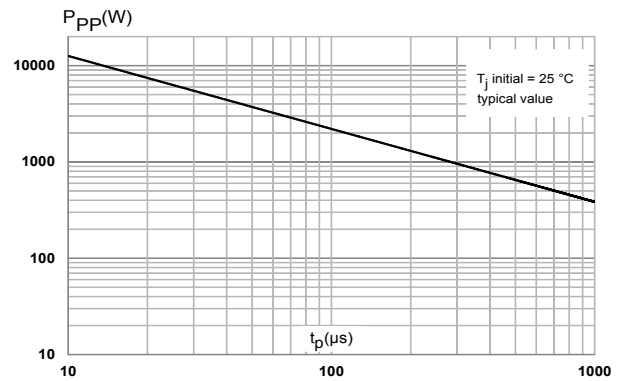
Symbol	Test condition	Min.	Typ.	Max.	Unit
$V_{BR}$	$I_R = 1\text{ mA}$	15.7	16.5	17.7	V
$V_{RM}$				15	V
$I_{RM}$	$V_{RM} = 12\text{ V}$			100	nA
$I_{RM}$	$V_{RM} = 15\text{ V}$			200	nA
$R_d$	8/20 $\mu$ s		0.07		$\Omega$
$V_{CL}$	$I_{PP} = 100\text{ A}, 8/20\text{ }\mu\text{s}$		24	26	V
$V_{CL}$	$I_{PP} = 160\text{ A}, 8/20\text{ }\mu\text{s}$		28	30	V
$C_{BUS}$	$V_{BUS} = 0\text{ V}, f = 1\text{ MHz}, V_{OSC} = 30\text{ mV}$		1200		pF

## 1.1 Characteristics (curves)

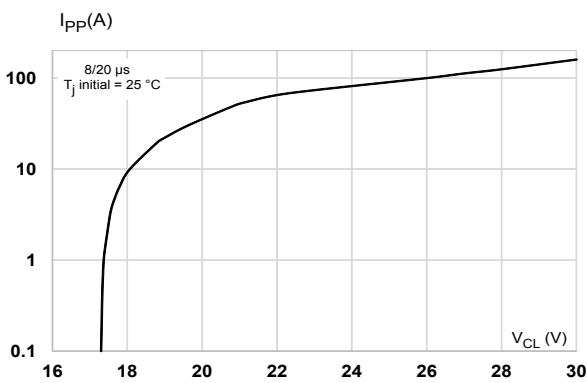
**Figure 2. Peak power dissipation versus initial temperature (typical value)**



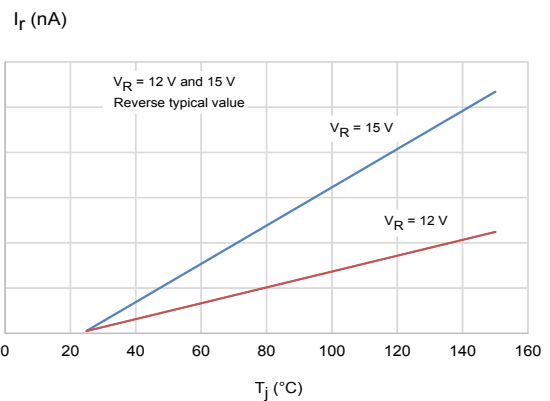
**Figure 3. Peak pulse power versus exponential pulse duration ( $T_j = 25^\circ\text{C}$ , typical value)**



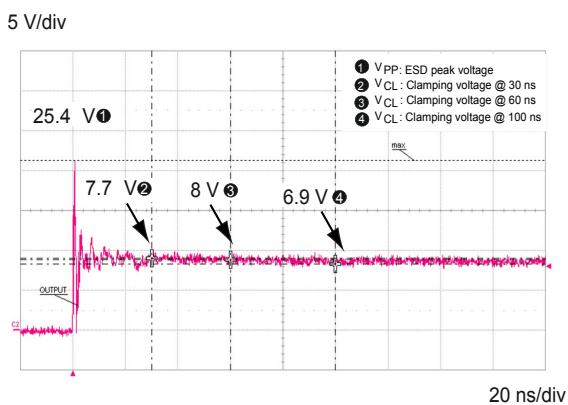
**Figure 4. Peak pulse current versus clamping voltage (max. value)**



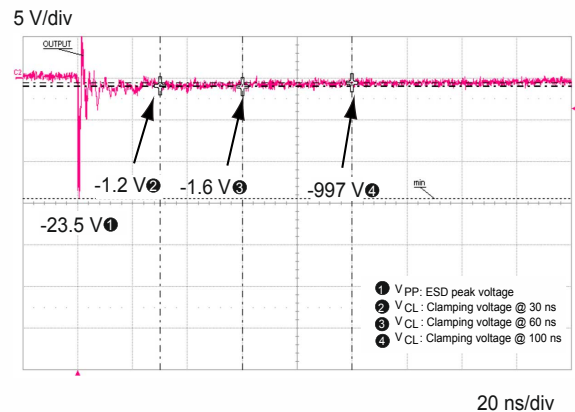
**Figure 5. Leakage current versus junction temperature (typical value)**



**Figure 6. ESD response to IEC 61000-4-2 (+8kV contact discharge)**



**Figure 7. ESD response to IEC 61000-4-2 (-8kV contact discharge)**

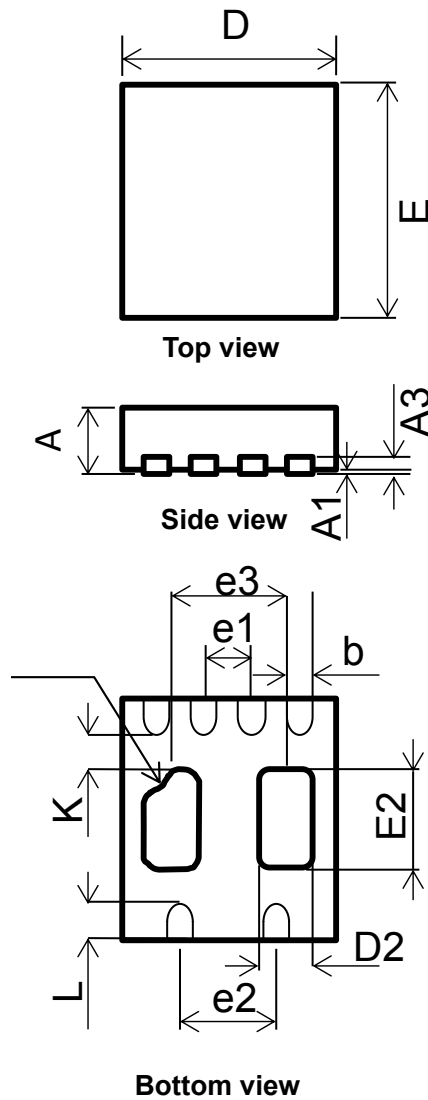


## 2 Package information

In order to meet environmental requirements, ST offers these devices in different grades of **ECOPACK** packages, depending on their level of environmental compliance. ECOPACK specifications, grade definitions and product status are available at: [www.st.com](http://www.st.com). ECOPACK is an ST trademark.

### 2.1 $\mu$ QFN package information

Figure 8.  $\mu$ QFN package outline



**Table 3. μQFN package mechanical data**

Ref.	Dimensions					
	Millimeters			Inches		
	Min.	Typ.	Max.	Min.	Typ.	Max.
A	0.51	0.55	0.60	0.0201	0.0217	0.0236
A1	0.00	0.02	0.05	0.0000	0.0008	0.0020
A3		0.15				
b	0.15	0.20	0.25	0.0059	0.0079	0.0098
D	1.70	1.80	1.90	0.0669	0.0709	0.0748
E	1.90	2.0	2.10	0.0748	0.0787	0.0827
e1		0.4			0.0157	
e2		0.80			0.0315	
D2	0.30	0.45	0.55	0.0118	0.0177	0.0217
E2	0.69	0.84	0.94	0.0272	0.0331	0.0370
e3		0.95			0.0374	
k		0.28			0.0110	
L	0.20	0.30	0.40	0.0079	0.0118	0.0157
N		6.00				

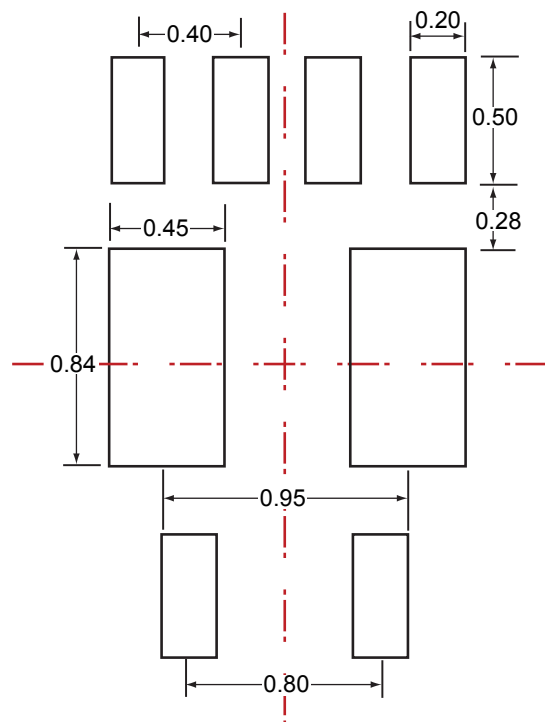
**Figure 9. μQFN footprint**


Figure 10. Marking layout

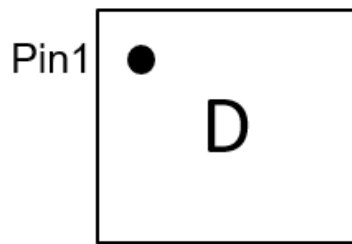


Figure 11. Package orientation in reel

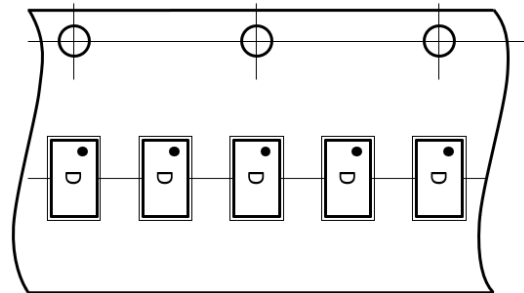


Figure 12. Tape outline

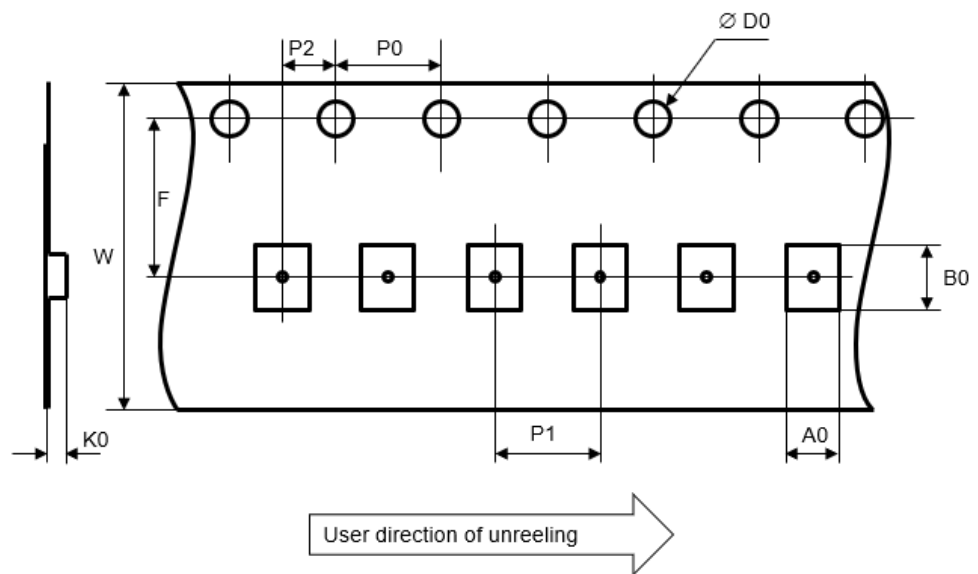


Table 4. Tape and reel mechanical data

Ref.	Dimensions		
	Millimeters		
	Min.	Typ.	Max.
A0	1.95	2.00	2.05
B0	2.25	2.30	2.35
D0	1.40	1.50	1.60
F	3.45	3.50	3.55
K0	0.70	0.75	0.80
P0	3.90	4.00	4.10
P1	3.90	4.00	4.10
P2	1.95	2.00	2.05
W	7.90	8.00	8.30

### 3 Recommendation on PCB assembly

#### 3.1 Stencil opening design

1. General recommendation on stencil opening design
  - a. Stencil opening dimensions: L (Length), W (Width), T (Thickness).
2. General design rule
  - a. Stencil thickness (T) = 75 ~ 125 μm
  - b. Aspect ratio =

$$\frac{W}{T} \geq 1.5 \quad (1)$$

- c. Aspect area =

$$\frac{L \times W}{2T(L + W)} \geq 0.66 \quad (2)$$

3. Reference design
  - a. Stencil opening thickness: 100 μm
  - b. Stencil opening for leads: Opening to footprint ratio is 90%.

Figure 13. Stencil opening dimensions

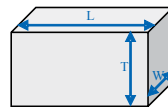
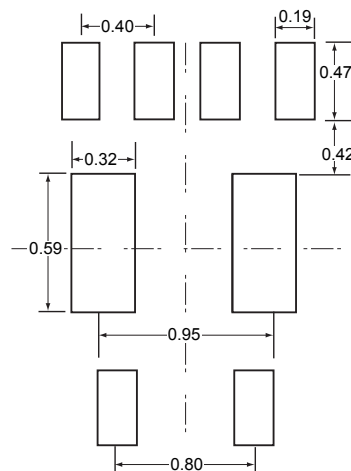


Figure 14. Recommended stencil window position



#### 3.2 Solder paste

1. Use halide-free flux, qualification ROL0 according to ANSI/J-STD-004.
2. "No clean" solder paste is recommended.
3. Offers a high tack force to resist component movement during PCB movement.
4. Solder paste with fine particles: powder particle size is 20-45 μm.

### 3.3 Placement

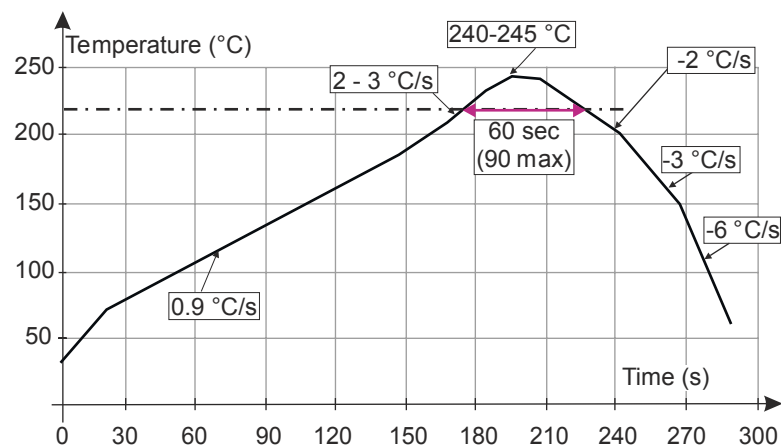
1. Manual positioning is not recommended.
2. It is recommended to use the lead recognition capabilities of the placement system, not the outline centering
3. Standard tolerance of  $\pm 0.05$  mm is recommended.
4. 3.5 N placement force is recommended. Too much placement force can lead to squeezed out solder paste and cause solder joints to short. Too low placement force can lead to insufficient contact between package and solder paste that could cause open solder joints or badly centered packages.
5. To improve the package placement accuracy, a bottom side optical control should be performed with a high resolution tool.
6. For assembly, a perfect supporting of the PCB (all the more on flexible PCB) is recommended during solder paste printing, pick, and place and reflow soldering by using optimized tools.

### 3.4 PCB design preference

1. To control the solder paste amount, the closed via is recommended instead of open vias.
2. The position of tracks and open vias in the solder area should be well balanced. A symmetrical layout is recommended, to avoid any tilt phenomena caused by asymmetrical solder paste due to solder flow away.

### 3.5 Reflow profile

**Figure 15. ST ECOPACK® recommended soldering reflow profile for PCB mounting**



**Note:** Minimize air convection currents in the reflow oven to avoid component movement.



## 4 ESDA17P100-1U2M\_Ordering information

Figure 16. Ordering information scheme

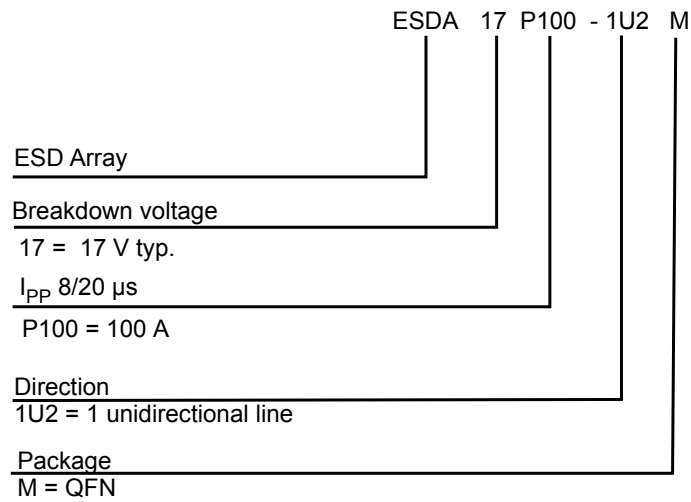


Table 5. Ordering information

Order code	Marking <sup>(1)</sup>	Package	Weight	Base qty.	Delivery mode
ESDA17P100-1U2M	D	$\mu$ QFN	6 mg	5000	Tape and reel

1. The marking can be rotated by multiples of 90° to differentiate assembly location

## Revision history

**Table 6. Document revision history**

Date	Revision	Changes
14-Mar-2017	1	Initial release.
07-Feb-2023	2	Updated package view, <a href="#">Figure 8</a> and <a href="#">Table 3</a> .

**IMPORTANT NOTICE – READ CAREFULLY**

STMicroelectronics NV and its subsidiaries (“ST”) reserve the right to make changes, corrections, enhancements, modifications, and improvements to ST products and/or to this document at any time without notice. Purchasers should obtain the latest relevant information on ST products before placing orders. ST products are sold pursuant to ST’s terms and conditions of sale in place at the time of order acknowledgment.

Purchasers are solely responsible for the choice, selection, and use of ST products and ST assumes no liability for application assistance or the design of purchasers’ products.

No license, express or implied, to any intellectual property right is granted by ST herein.

Resale of ST products with provisions different from the information set forth herein shall void any warranty granted by ST for such product.

ST and the ST logo are trademarks of ST. For additional information about ST trademarks, refer to [www.st.com/trademarks](http://www.st.com/trademarks). All other product or service names are the property of their respective owners.

Information in this document supersedes and replaces information previously supplied in any prior versions of this document.

© 2023 STMicroelectronics – All rights reserved