

PART NUMBER	ITEM ① BOLT	ITEM ② NUT	ITEM ③ WASHER	ITEM ④ WASHER
40-98440F-C	BRASS NICKEL PLATED	STEEL NICKEL PLATED	STEEL NICKEL PLATED	STEEL NICKEL PLATED

REV	ECO	DATE
001	<del>ECO-11-0127</del>	04/02/2011
002	ECO-11-0127	07/26/2011
003	ECO-12-0335	12/19/2012
004	ECO-18-0023	09/04/2018

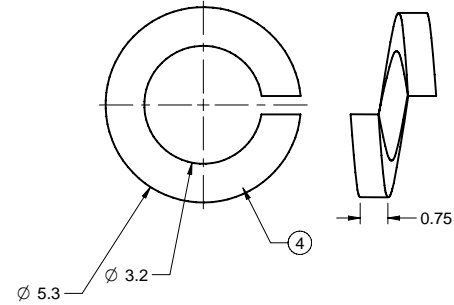
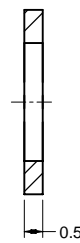
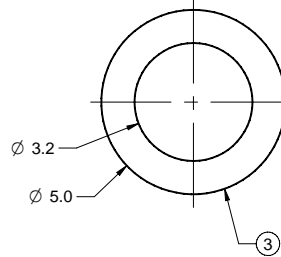
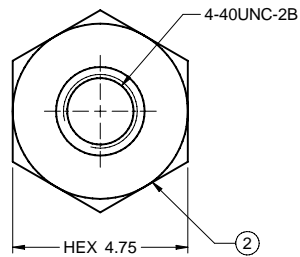
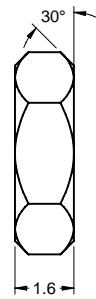
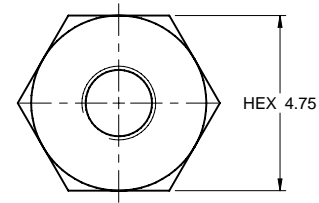
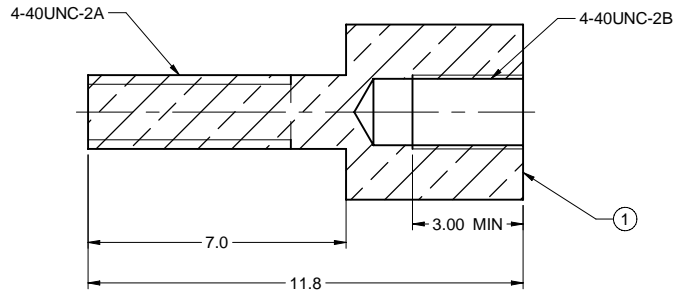

NOTES:

1. . PRODUCT SHOULD BE RoHS COMPLIANCE.
2. PACKAGING REQUIREMENT FOLLOWS ENGINEER DOCUMENT P/N 836-40200001XX

40-98440F-C	F SCREW LOCKS,.30"(50 SET)
40-98440F	F SCREW LOCKS,.30"(1 SET)

	Model No.	40-98440F-C	<b>AIM-Cambridge</b>	
	RoHS2	2011/65/EU	RoHS COMPLIANCE	N/A
	Scale	X +1.5	File:	F SCREW LOCKS, .30" (1 SET)
	Drawn By	Betty Yu	Drawing No.	40-98440F-C
	Date:	09/04/2018	Rev:	004
	Angles	5°	DO NOT SCALE DRAWING	N/A
	Sheet	2 of 2		