



STM32100E-EVAL demonstration firmware

Introduction

This user manual describes the demonstration firmware running on the STM32100E-EVAL evaluation board, which can be used to evaluate the capabilities of the high-density value line STM32F100ZET6 microcontroller and on-board peripherals.

This demo contains many applications that can be easily reused, such as RTC calendar, file system FAT implementation on SD Card, Waveplayer with STM32 DAC peripheral, HDMI CEC networking demo with an infrared remote control capability, temperature sensor interfacing and TFT LCD with touch screen.

The STM32100E-EVAL board is delivered with the demonstration programmed in the internal Flash memory, and all the files needed by the demonstration are programmed in the MicroSD card. At each reset (board power-up, external reset, etc.), the demonstration is executed.

In case the STM32100E-EVAL board was not factory-programmed or the demonstration application was erased, the in-circuit programming (ICP) boot loader can be used to program this file. For more details, refer to [Section 3: STM32100E-EVAL demonstration package](#) and [Section 4: STM32100E-EVAL demonstration programming](#).

This demonstration firmware is available for download from the STMicroelectronics website: www.st.com.

Contents

- 1 Evaluation board overview 7**
 - 1.1 Power control 8
 - 1.2 Clocking 8
 - 1.3 Reset control 8
 - 1.4 Debugging JTAG interface 8
 - 1.5 Serial wire debugger interface 8
 - 1.6 Embedded ST-LINK 8
 - 1.7 Display devices 8
 - 1.7.1 LCD 8
 - 1.7.2 LEDs 8
 - 1.8 Interfaces 9
 - 1.8.1 RS232 9
 - 1.9 Motor control 9
 - 1.10 IrDA 9
 - 1.11 Miscellaneous peripherals 9
 - 1.11.1 Joystick 9
 - 1.11.2 Push-buttons 9
 - 1.11.3 12-bit analog-to-digital converter (ADC) 9
 - 1.11.4 Audio amplifier 9
 - 1.11.5 Storage memories 9
 - 1.11.6 Temperature sensor 10

- 2 Running the demonstration 11**
 - 2.1 Menu tree and navigation 11
 - 2.2 Demonstration startup 12
 - 2.3 Time and date configuration 14
 - 2.4 Menu navigation 14
 - 2.4.1 Navigation procedure 15
 - 2.5 Clock sources 16
 - 2.5.1 Clock control 16
 - 2.5.2 Clock failure 17
 - 2.6 STM32F100ZET6 resources 18

2.6.1	Peripherals	18
2.6.2	Interrupts	19
2.6.3	External interrupts	20
2.6.4	Internal memory organization	20
2.6.5	External memory organization	20
2.7	Demonstration applications	22
2.7.1	Product presentation	22
2.7.2	Calendar	24
2.7.3	Image Viewer submenu	29
2.7.4	Wave Player submenu	30
2.7.5	Low power modes	32
2.7.6	Infrared decoding	37
2.7.7	Thermometer	38
2.7.8	HDMI™ CEC submenu	39
2.7.9	Help submenu	42
2.7.10	About submenu	43
3	STM32100E-EVAL demonstration package	44
3.1	Libraries	45
3.2	Project	45
3.3	Utilities	45
4	STM32100E-EVAL demonstration programming	46
4.1	Programming the media files	46
4.2	Programming the demonstration	46
4.2.1	Using IAP	47
5	Revision history	48

List of tables

Table 1.	STM32F100ZET6 demonstration peripherals.....	18
Table 2.	STM32F100ZET6 demonstration interrupts.....	19
Table 3.	STM32F100ZET6 demonstration external interrupts.....	20
Table 4.	Document revision history.....	48

List of figures

Figure 1.	Evaluation board overview	7
Figure 2.	Structure of the demonstration menus	12
Figure 3.	SD Card check	13
Figure 4.	Warning message	13
Figure 5.	ST logo	13
Figure 6.	STM32 presentation slide	14
Figure 7.	Time and date configuration	14
Figure 8.	Application main menu	15
Figure 9.	Application submenus	15
Figure 10.	Navigating in the demonstration menus	16
Figure 11.	Clock tree diagram	17
Figure 12.	No HSE clock detected	17
Figure 13.	Standby mode entered	18
Figure 14.	Internal Flash memory organization	20
Figure 15.	MicroSD Card organization	21
Figure 16.	Card removal	22
Figure 17.	Product presentation is ready to start	22
Figure 18.	First presentation slide	23
Figure 19.	Last presentation slide	23
Figure 20.	No loaded wave file	24
Figure 21.	End of slide show	24
Figure 22.	Setting the time and date	25
Figure 23.	Time Adjust submenu	25
Figure 24.	Time Show submenu	26
Figure 25.	Setting the year	26
Figure 26.	Setting the month	27
Figure 27.	Setting the day of the month	27
Figure 28.	Date Show submenu	27
Figure 29.	Setting the alarm activation time	28
Figure 30.	Alarm Show submenu	28
Figure 31.	Time and date not configured	29
Figure 32.	Image Viewer submenu	29
Figure 33.	Wave Player submenu	30
Figure 34.	Wave Player interface	30
Figure 35.	Wave Player Playing submenu	31
Figure 36.	Pause submenu	31
Figure 37.	Stop mode menu	32
Figure 38.	Stop mode entered	32
Figure 39.	MCU in Stop mode	33
Figure 40.	RTC Alarm wakes up the MCU from Stop mode	33
Figure 41.	Setting the wakeup time	33
Figure 42.	RTC Alarm wakeup configured	34
Figure 43.	RTC Alarm wakeup	34
Figure 44.	Time and Date configuration prompt	34
Figure 45.	Entering Standby mode	35
Figure 46.	MCU in Standby mode	35
Figure 47.	Setting the wakeup time	36
Figure 48.	RTC Alarm wakeup configured	36

Figure 49.	Time and Date configuration prompt	36
Figure 50.	Infrared Decoding menu	37
Figure 51.	Infrared protocol submenu	37
Figure 52.	Thermometer submenu selected	38
Figure 53.	Temperature display	38
Figure 54.	Warning temperature display	39
Figure 55.	Temperature sensor error	39
Figure 56.	HDMI CEC submenu selected	40
Figure 57.	HDMI CEC configuration submenu	40
Figure 58.	CEC menu	40
Figure 59.	Select CEC command	41
Figure 60.	Receive subscreen information	41
Figure 61.	Help submenu	42
Figure 62.	Joystick push-buttons	42
Figure 63.	Second Help slide	43
Figure 64.	About submenu	43
Figure 65.	STM32100E-EVAL demonstration package directory tree	44
Figure 66.	SD Card directory organization	46

1 Evaluation board overview

The STM32100E-EVAL evaluation board provides a development and demonstration platform for STM32F100Zx-based applications. It is used to evaluate the major functions of the STM32F100ZET6 microcontroller.

Figure 1 summarizes the main functional blocks of the evaluation board.

Figure 1. Evaluation board overview

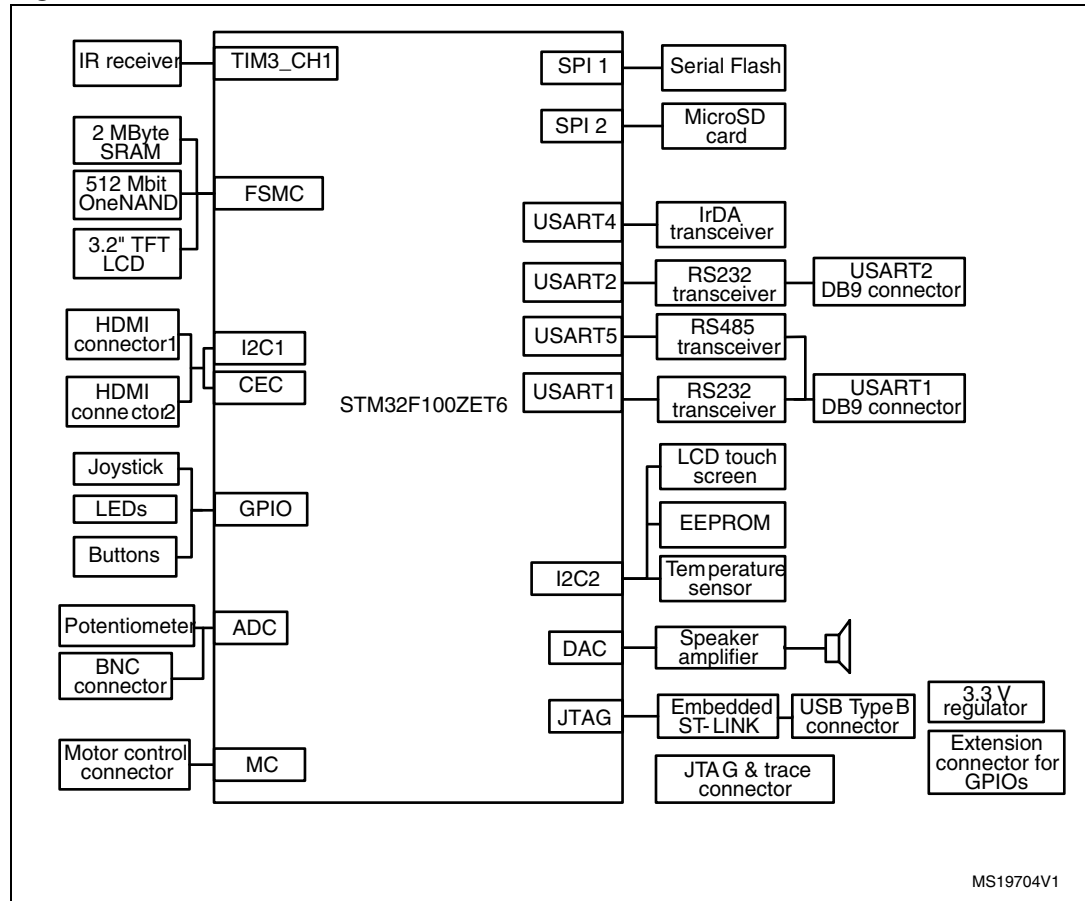

1.1 Power control

The evaluation board can be powered from an external 5 V supply or from the USB connector. All other required voltages are provided by on-board voltage regulators.

1.2 Clocking

Two clock sources are available on the STM32100E-EVAL evaluation board:

- 32 kHz crystal for embedded RTC
- 8 MHz crystal for the STM32F100ZET6 main clock system

1.3 Reset control

The reset can be generated by hardware or software:

- Reset button: activates the RESET input when pressed
- JTAG reset

1.4 Debugging JTAG interface

Software debug is done via the standard ARM[®] JTAG interface, a 20-pin IDC (insulation displacement connector) for connection to the standard ARM host interface.

1.5 Serial wire debugger interface

The serial wire debug port (SWD-DP) provides a 2-pin (clock + data) interface to the AHP-AP port.

1.6 Embedded ST-LINK

The ST-LINK in-circuit debugger/programmer is embedded on the board. It supports the STM32F100ZET6 MCU.

1.7 Display devices

1.7.1 LCD

A color LCD module is mounted on the STM32100E-EVAL board. It is interfaced through FSMC of STM32F100ZET6.

1.7.2 LEDs

Four general-purpose LEDs are available.

1.8 Interfaces

1.8.1 RS232

The STM32F100ZET6 evaluation board (STM32100E-EVAL) provides two on-board RS232 serial ports. Both RS232 ports are accessed via DB9 connectors.

1.9 Motor control

The STM32100E-EVAL evaluation board supports inductor motor control via a 34-pin connector. This connector provides all required control and feedback signals to and from the motor power-driving board.

1.10 IrDA

The STM32100E-EVAL evaluation board supports IrDA communication. The interface is mounted on UART4.

1.11 Miscellaneous peripherals

1.11.1 Joystick

The board features a four-direction joystick with a selection key.

1.11.2 Push-buttons

The following push-buttons are available:

- Key
- Tamper
- Wakeup: used to wake up the processor from low power mode

1.11.3 12-bit analog-to-digital converter (ADC)

The MCU ADC channel (ADC1_IN14) is connected to an on-board variable resistor. The variable resistor provides a voltage in the range of 0 V to 3.3 V.

Moreover, a BNC connector is available for analog input.

1.11.4 Audio amplifier

The STM32100E-EVAL evaluation board implements a dedicated audio amplifier which can be interfaced with the STM32 DAC peripheral. For the audio output, a speaker and an audio jack connector are available on the board and connected to the DAC.

1.11.5 Storage memories

The STM32100E-EVAL evaluation board features an 8 Mbyte SPI Flash memory and an SD Card™ memory connected to the SPI2 peripheral. It features also an 64 Kbyte I²C EEPROM memory connected to I2C2.

1.11.6 Temperature sensor

The STM32100E-EVAL evaluation board includes an I²C temperature sensor connected to the I2C2 peripheral.

2 Running the demonstration

2.1 Menu tree and navigation

Figure 2 shows the menu system of the STM32F100ZET6 demonstration. The main menu is shown on the left-hand side. The UP, DOWN, RIGHT and LEFT joystick directions allow the user to navigate between items in the main menu and the submenus.

The user can also navigate through the demonstration menu by using the touch screen. The touch screen works only at the first level of the demonstration (main menu).

To enter a submenu, press the SEL push-button. The SEL push-button designates the action of vertically pressing the top of the joystick, as opposed to moving it horizontally UP, DOWN, RIGHT or LEFT.

To exit a submenu, select the **Return** menu and press SEL.

Figure 2. Structure of the demonstration menus

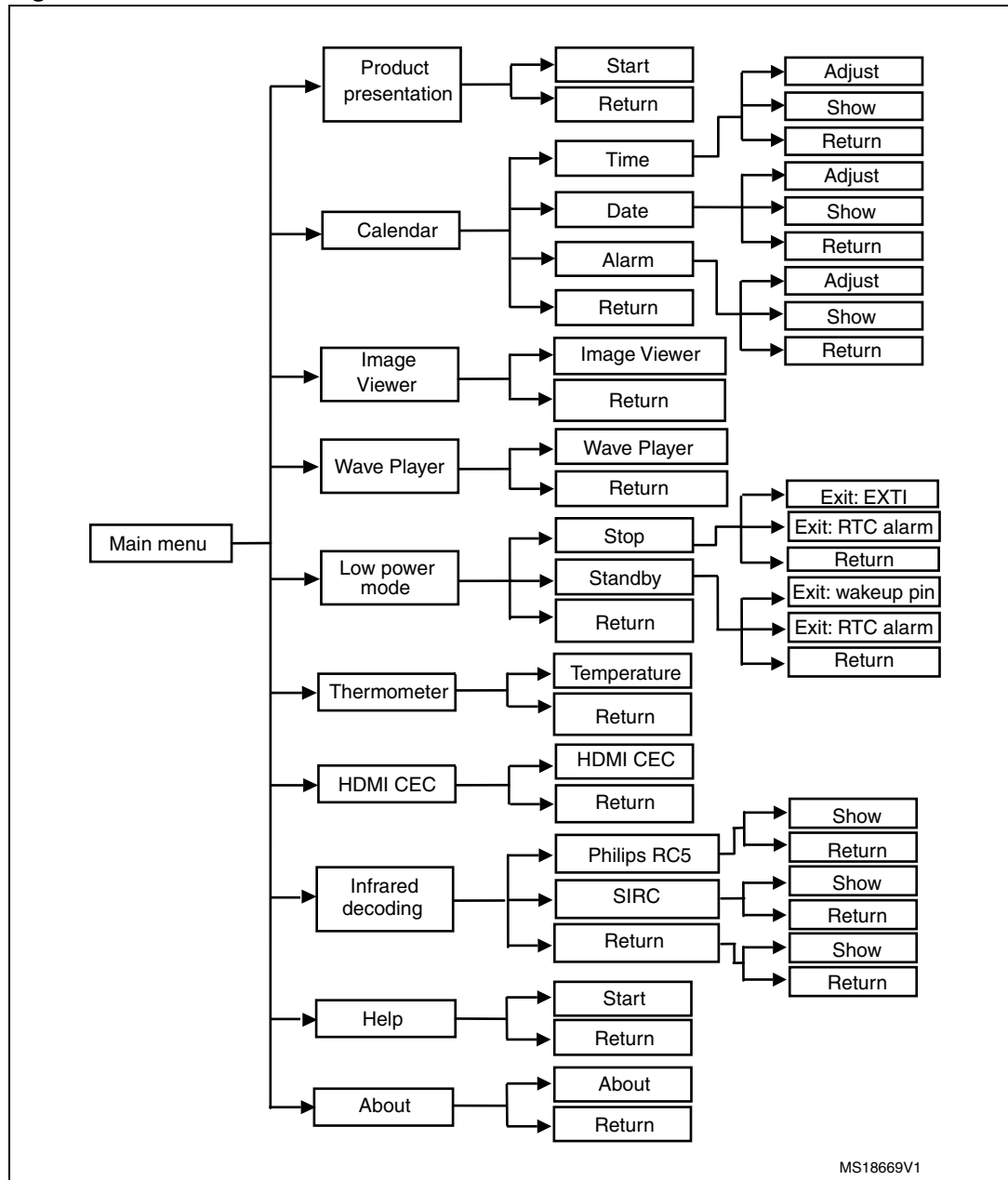

MS18669V1

2.2 Demonstration startup

The demonstration starts after a board reset. The system checks if an SD memory card is already plugged into the connector CN6. If no card detected, the demonstration does not start and the message shown in [Figure 3](#) is displayed on the LCD screen.

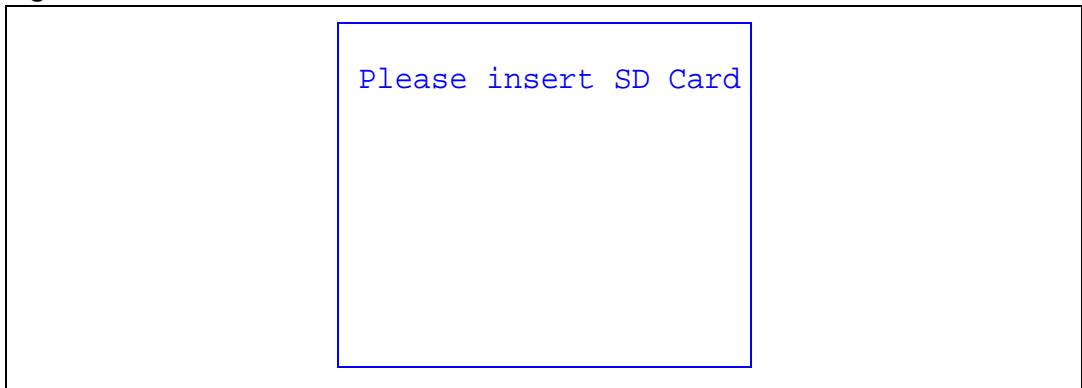
Figure 3. SD Card check

To continue the demonstration, insert an SD Card. The demonstration graphic icons and bitmap files are now checked in the MicroSD Card (see [Section 2.6.5: External memory organization](#)). All the icons have to be correctly programmed in the MicroSD Card for the demonstration to start. If an icon is missing, the demonstration does not start and the message shown in [Figure 4](#) is displayed on the LCD screen.

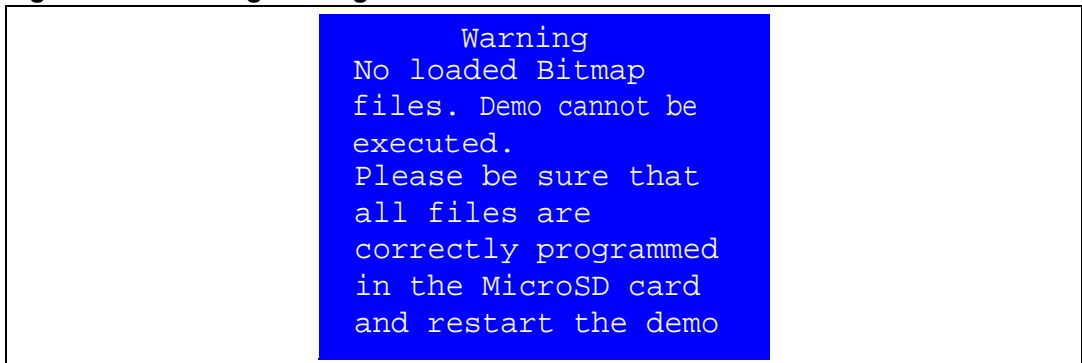
Figure 4. Warning message

If the icons are correctly loaded into the SD Card memory, the welcome screen is displayed and the ST logo appears on the LCD screen:

Figure 5. ST logo

After some seconds, the following STM32 slide is displayed on the LCD screen:

Figure 6. STM32 presentation slide



2.3 Time and date configuration

When the board is powered up for the first time and no power supply is detected on V_{BAT} (battery), you are prompted to set the time, year, month and day. The following message appears on the LCD screen.

Figure 7. Time and date configuration

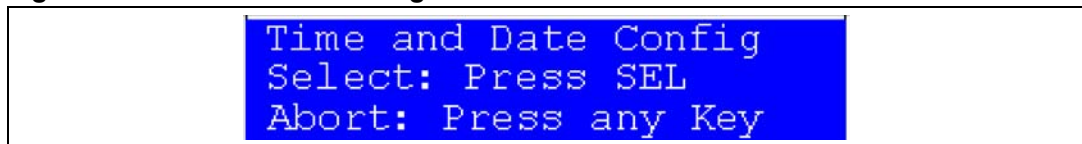

To set the time and date, press the SEL push-button. The **Time Adjust** and **Date Adjust** menus are displayed. Use the joystick UP/DOWN and SEL push-buttons to set the time/date.

To ignore the configuration sequence, press any key except for the SEL push-button. The main menu is displayed.

- Note:*
- 1 You can set the time parameters at any time by using the **Calendar** menu (see [Section 2.7.2: Calendar](#)).
 - 2 If the time has already been configured, then the number of elapsed days (higher than 1 day) since the last time the demonstration board was powered up appears on the LCD screen. It is soon followed by the current date.

2.4 Menu navigation

Once the time/date have been set, the main menu appears. The main menu is displayed in the form of a set of icons. It shows all the submenus in the same screen. You can navigate through the submenus by pressing the joystick UP, DOWN, RIGHT and LEFT. To enter the desired submenu, press the SEL joystick push-button or push on the desired icon, and the submenu corresponding to the selected icon is displayed.

Figure 8. Application main menu



Note: The icons shown in [Figure 8](http://commons.wikimedia.org/wiki/Crystal_Clear) are taken from http://commons.wikimedia.org/wiki/Crystal_Clear.

Once a submenu has been selected, the name of the application is listed at the top of the display and all the corresponding submenus are listed below as shown in [Figure 9](#).

Figure 9. Application submenus

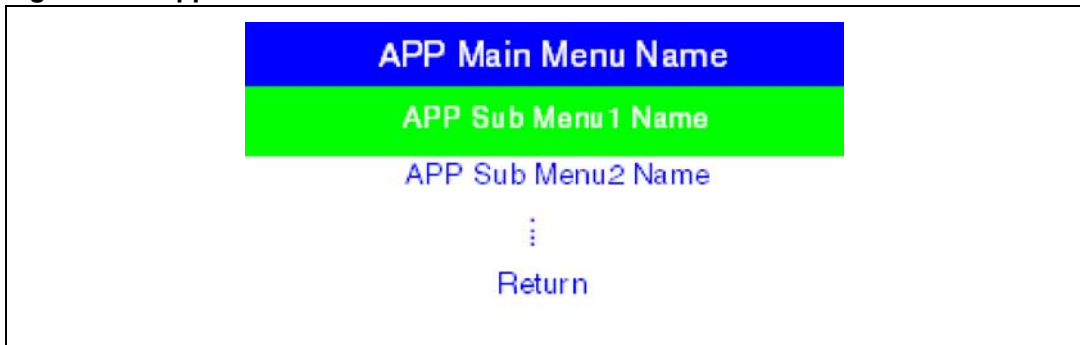

2.4.1 Navigation procedure

The demonstration menu is based on circular navigation, submenu selection, item selection and back navigation.

To navigate through the demonstration menus, use the joystick push-buttons located on the evaluation board: RIGHT, LEFT, UP, DOWN and SEL.

- The UP, DOWN, RIGHT and LEFT push-buttons are used to perform circular navigation in the main menu and the current menu items.
- TOUCH SCREEN is used also to perform navigation only in the main menu.
- The SEL push-button selects the current item.
- The UP and DOWN push-buttons are used for vertical navigation in the submenus.

To return to the upper menu, go to the **Return** menu and press SEL.

Figure 10. Navigating in the demonstration menus

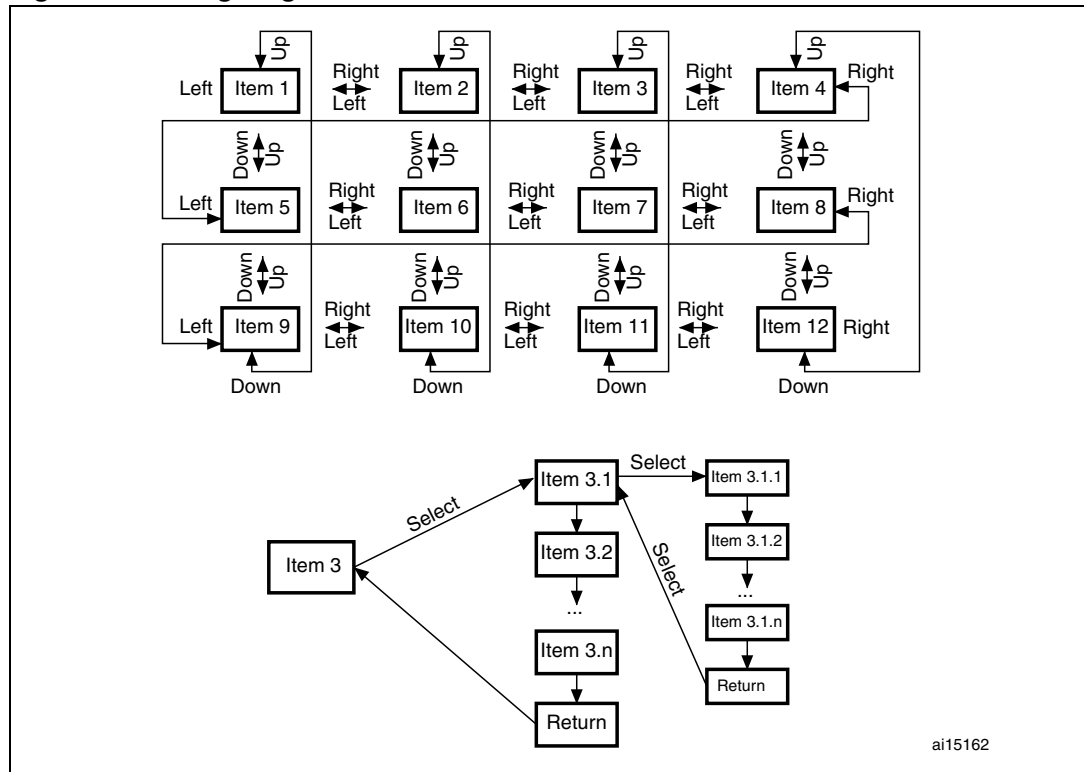

2.5 Clock sources

2.5.1 Clock control

The STM32F100ZET6 internal clocks are derived from the HSE clocked by the external 8 MHz crystal.

In this demonstration application, the various system clocks are configured as follows:

- The system clock is set to 24 MHz. The PLL is used as the system clock source: 24 MHz.
- The HCLK frequency is set to 24 MHz.
- The timer clock (TIMCLK) is set to 24 MHz.
- PCLK1 is set to 24 MHz.
- PCLK2 is set to 24 MHz.

Only the RTC is clocked by a 32 kHz external oscillator.

Figure 11 illustrates the clock tree organization for this demonstration.

Figure 11. Clock tree diagram

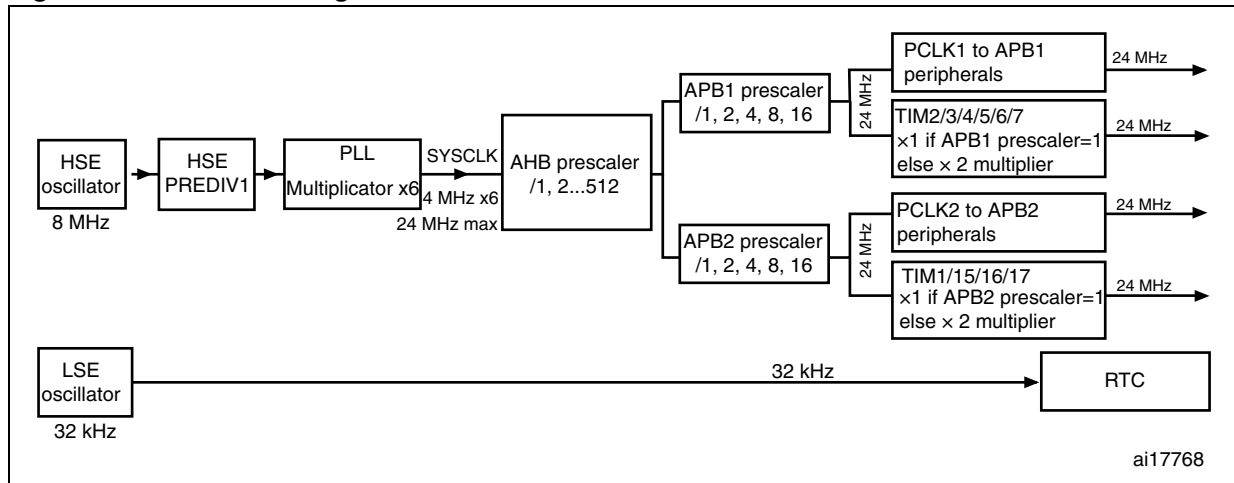

2.5.2 Clock failure

At any point of the demonstration, if no clock is present on OSC_IN (broken or disconnected crystal), the message shown in [Figure 12](#) is displayed on the LCD screen.

Figure 12. No HSE clock detected

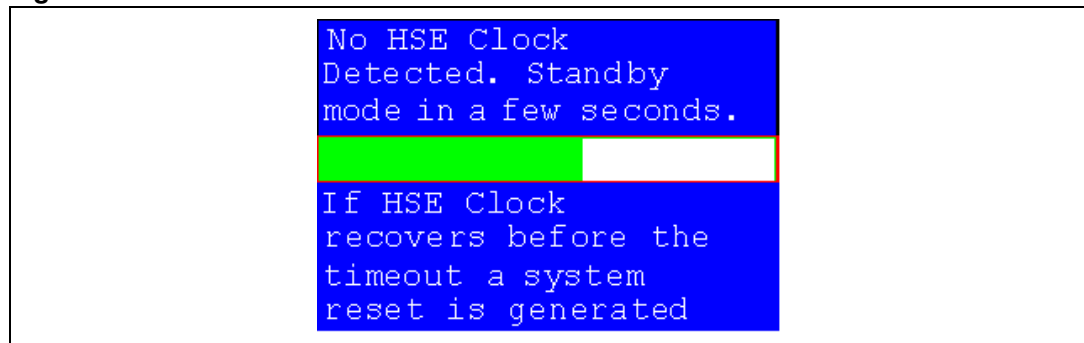

If no clock is detected, the clock security system (CSS) feeds the MCU with the HSI OSC used as an emergency clock.

The demonstration will not restart as long as the 8 MHz crystal is not present. You must connect the crystal before starting the demonstration. Connecting the 8 MHz crystal after reset may not restart the demonstration correctly.

If the 8 MHz crystal is not reconnected in the next few seconds, the MCU enters Standby mode. If the 8 MHz crystal is reconnected within a few seconds, a system reset is generated.

When a timeout occurs, the MCU enters Standby mode and the message shown in [Figure 13](#) is displayed on the LCD screen.

Figure 13. Standby mode entered

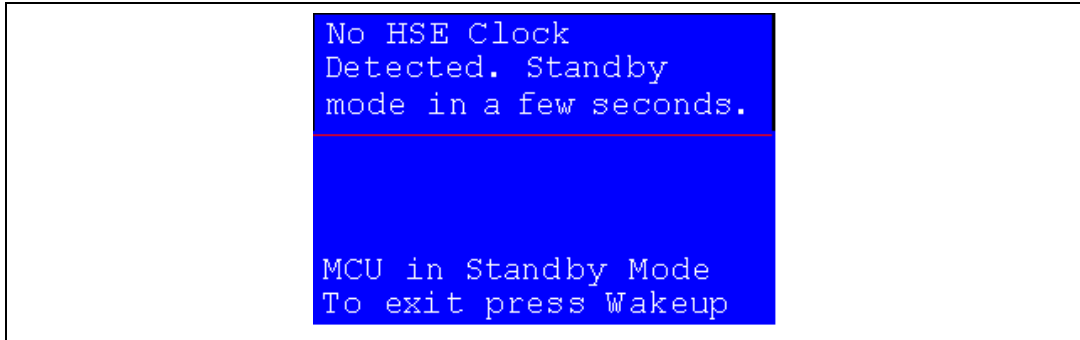

2.6 STM32F100ZET6 resources

2.6.1 Peripherals

All used peripherals are described in [Table 1](#).

Table 1. STM32F100ZET6 demonstration peripherals

Used peripherals	Applications
I2C2	Temperature sensor
BKP	Calendar + demo kernel
EXTI	Menu navigation + joystick + push-button + low power modes
GPIO	All applications + LEDs
NVIC	All applications using interrupts
PWR	Low power modes
RCC	All applications + demo kernel
RTC	Calendar
FSMC	Color LCD
SysTick	Generate 10 ms time base
TIM1	LED toggling
DMA2	Wave Player
TIM6	Wave Player
DAC	Wave Player
SPI1	SPI Flash
SPI2	MSD
TIM3	Infrared decoding
CEC	HDMI-CEC

2.6.2 Interrupts

Table 2 shows all the enabled interrupts.

Table 2. STM32F100ZET6 demonstration interrupts

Interrupts	Priority	Used for
SysTick	Preemption: 0 SubPriority: 0	System timing
RTC	Preemption: 0 SubPriority: 0	Calendar, date update
NMI	Preemption(fixed): -2	CSS interrupt
EXTI0	Preemption: 2 SubPriority: 1	Menu navigation
EXTI9_5	Preemption: 2 SubPriority: 1	Menu navigation
EXTI15_10	Preemption: 0 SubPriority: 0	Menu navigation
I2C2 Error	Preemption: 0 SubPriority: 0	SMBus Alert interrupt
TIM6_UP	Preemption: 0 SubPriority: 1	Sampling rate
TIM1_UP	Preemption: 1 SubPriority: 3	LED toggling
RTC Alarm	Preemption: 0 SubPriority: 1	Alarm generation
TIM3_IRQ	Preemption: 1 SubPriority: 0	Infrared decoding
CEC	Preemption: 1 SubPriority: 1	CEC transactions

2.6.3 External interrupts

Table 3. STM32F100ZET6 demonstration external interrupts

External interrupts	Used for
EXTI line7	Joystick SEL (interrupt mode, falling edge)
EXTI line8	CEC Interrupt (interrupt mode, falling edge)
EXTI line11	Joystick DOWN interrupt (interrupt mode, falling edge) & SD-Card-Detection (interrupt mode, rising edge)
EXTI line12	IO expander Interrupt (interrupt mode, rising/falling edge)
EXTI line13	TAMPER push-button (interrupt mode, falling edge)
EXTI line15	Joystick UP (interrupt mode, falling edge)
EXTI line17	RTC alarm (interrupt mode, rising edge)

2.6.4 Internal memory organization

Figure 14. Internal Flash memory organization

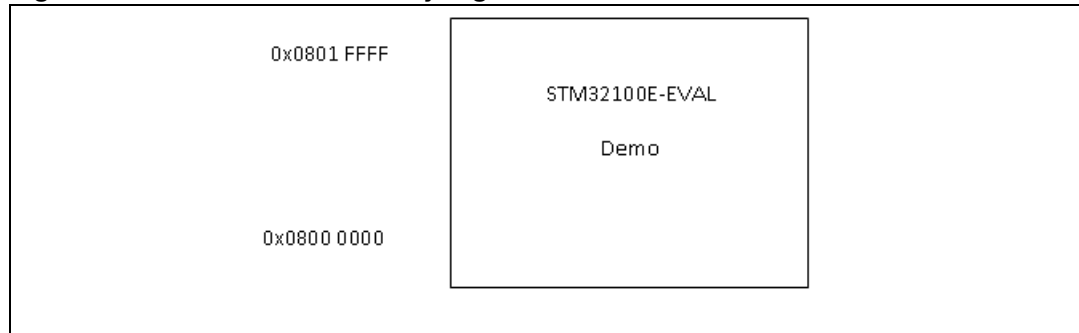

2.6.5 External memory organization

The STM32100E-EVAL demonstration is based on an embedded free FAT file system, DosFs^(a). The file system is needed to read all media information from the on-board MicroSD memory card.

a. The DosFs is a FAT-compatible filesystem intended for fairly low-end embedded applications. It is not the leanest possible implementation (the leanest FAT implementations operate in << 512 bytes of RAM, with heavy restrictions). This code strikes a good balance between size and functionality, with an emphasis on RAM footprint. For more details, refer to the following link <http://www.larwe.com/zws/products/dosfs/index.html>.

The SD Card memory is organized in two subdirectories:

- STFILES: this folder contains all required demo media files (icons, wave and slides). User files located in this folder cannot be handled by the demonstration; only default files are managed. The STFILES directory and its internal files are mandatory for demonstration startup.
- USER: this is a user folder. You can add here your 16-bit bitmap images (320x240) and waves. This folder is used only by the Image Viewer and Wave Player submenus. For more details on the different files properties, please refer to [Section 2.7.3: Image Viewer submenu](#) and [Section 2.7.4: Wave Player submenu](#).

Figure 15. MicroSD Card organization

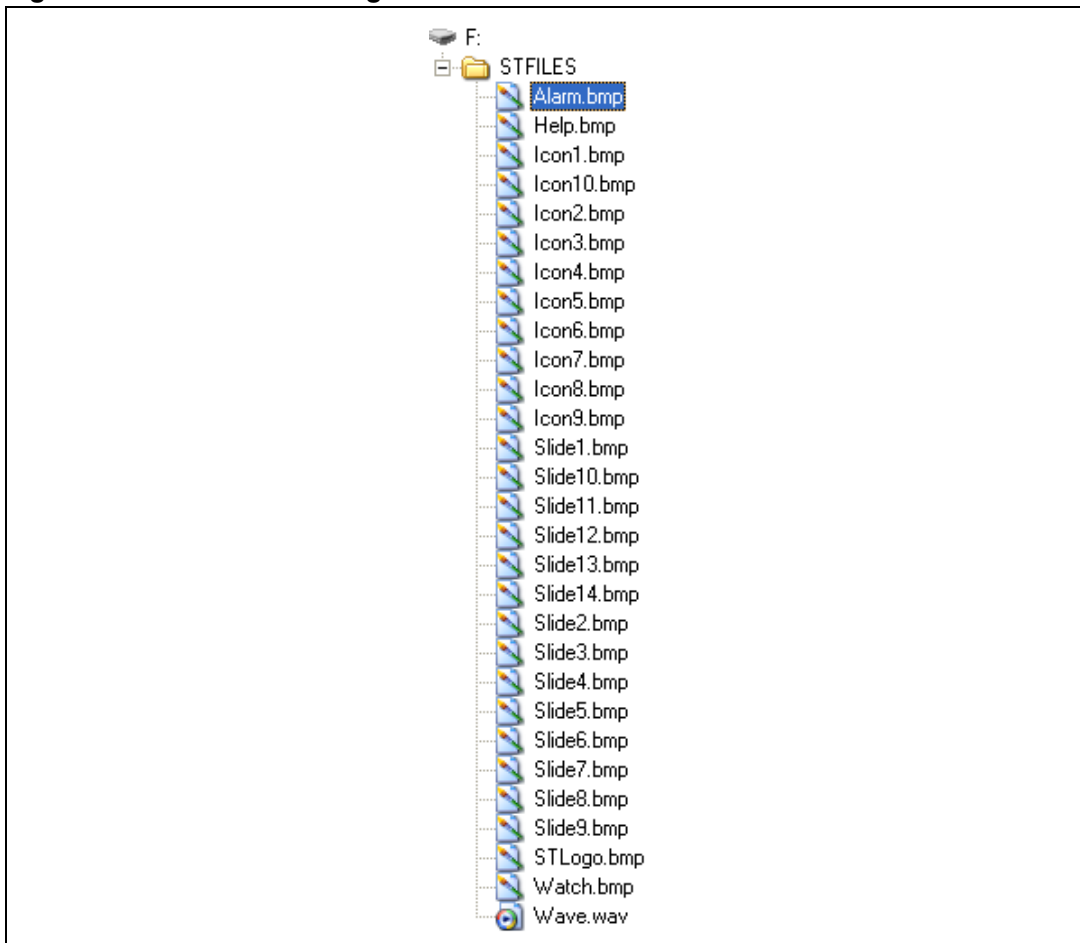

At the main menu and at any point of these applications (Product Presentation, Image Viewer and Wave Player), if the SD is removed, the demonstration stops and the message shown in [Figure 16](#) is displayed on the LCD screen. For the others applications, the message shown in [Figure 16](#) is displayed when the user exits the current application.

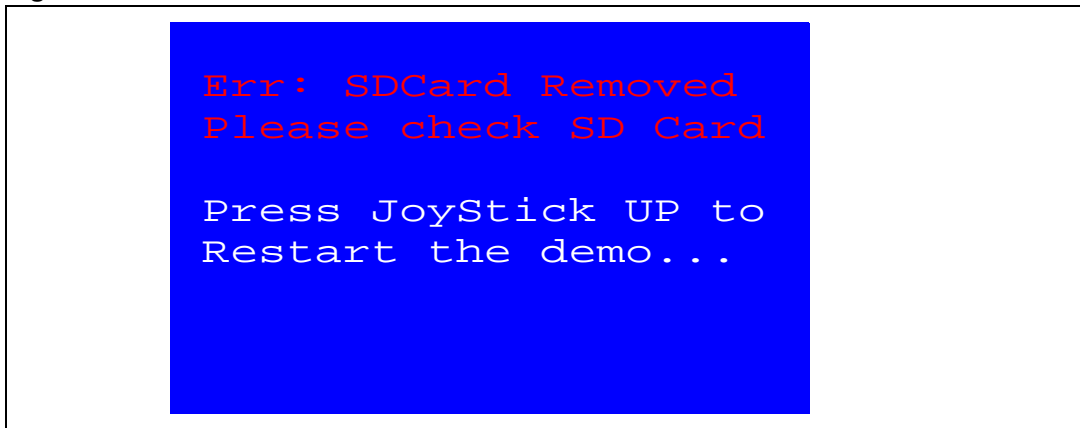
Figure 16. Card removal

2.7 Demonstration applications

The following section provides a detailed description of each part of the demonstration.

In the demonstration, the core runs at HCLK = 24 MHz. Four LEDs: LD1, LD2, LD3 and LD4 flash throughout the demonstration at a frequency depending on the core clock.

2.7.1 Product presentation

This part of the demonstration presents all the STM32F100ZET6 embedded peripherals and features. The product presentation is made with a slide show. Each slide is associated with a dedicated speech. When you start the product presentation, the first slide appears and the corresponding speech starts. Once the speech is finished, the second slide is displayed accompanied by its speech and so on until the last slide.

When the **Product presentation** menu is selected, the message shown in [Figure 17](#) is displayed on the LCD screen.

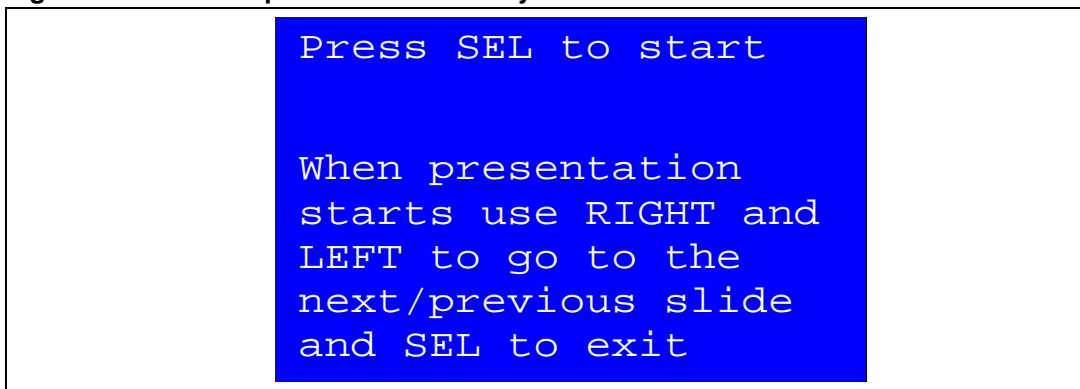
Figure 17. Product presentation is ready to start

Product presentation slides

The presentation is composed of 14 slides where all features and advantages of the STM32F100ZET6 are listed. *Figure 18* and *Figure 19* show the first and last slides, respectively.

Figure 18. First presentation slide



Figure 19. Last presentation slide



Product presentation speech

The STM32100E-EVAL features an external audio amplifier used to play speech audio files through the embedded speaker.

The properties of the product presentation speech wave file are the following:

- Playing time: 6 min 16s
- File size: 3 014 752 bytes
- Format tag: PCM
- Channels: Mono
- Sample rate: 8 kHz
- Bits per sample: 8 bits

If the wave file of the promotion presentation speech is not loaded in the dedicated memory, the message shown in [Figure 20](#) is displayed on the LCD screen.

Figure 20. No loaded wave file

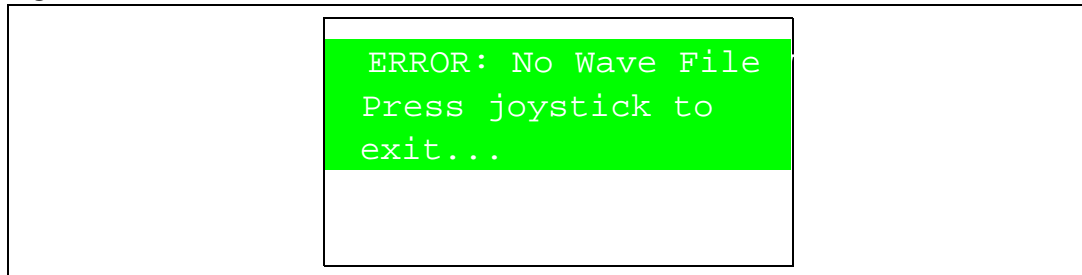

To stop the product presentation slide show and speech, push the SEL push-button. The message shown in [Figure 21](#) is displayed.

Figure 21. End of slide show

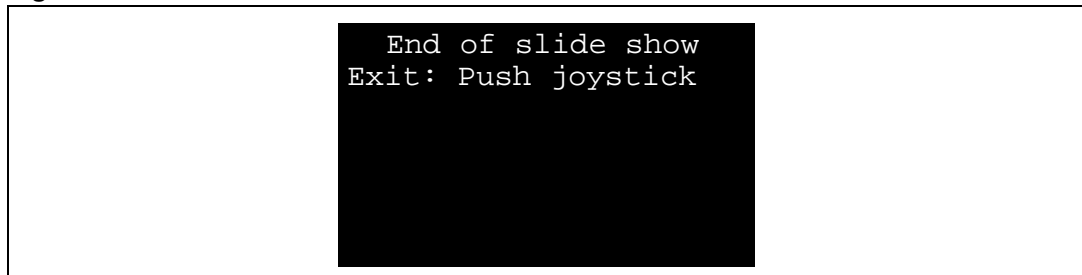

At the end of the product presentation, or if the presentation was stopped, simply press any joystick key to exit and return to the **Product Presentation** submenu.

2.7.2 Calendar

The STM32F100ZET6 features a real-time clock (RTC) that provides a set of continuously running counters. These can be used, with suitable software, to implement a clock-calendar function. The counter values can be written to set the current time of the system.

This submenu is used to configure the time, date and alarm. The date, time and alarm settings are not lost when the board is powered off owing to the battery connected to the V_{BAT} pin. The V_{BAT} pin supplies power to the RTC unit, allowing the RTC to operate even when the main digital supply (V_{DD}) is turned off.

Note: To be able to use the battery to back up the RTC, the JP1 jumper must be in the position *Battery-VDD* on the STM32100E-EVAL board.

In any submenu, if the time and date parameters have not yet been configured, the message shown in [Figure 22](#) is displayed on the LCD screen.

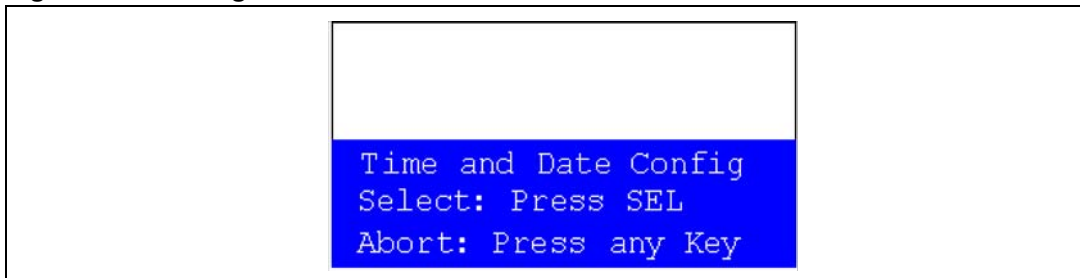
Figure 22. Setting the time and date

You have the choice to set or not the time, year, month and day. Press any key (except for SEL) to ignore the prompt and abort the configuration sequence. Press on SEL and follow the setting sequence to set the time and date.

Time submenu

This submenu is divided into two items that allow you to display or set the current time:

- **Time Adjust:** after powering up the evaluation board, you can use this submenu to change the default time (00:00:00) to the current time.

To adjust the time:

1. Select **Time Adjust**. The message shown in [Figure 23](#) is displayed on the LCD. To modify the first digit of the hour field, use the UP and DOWN push-buttons. Press UP to display the current value plus one. Press DOWN to display the previous digit value.
2. After setting the digit value, press SEL. The cursor automatically jumps to the next digit.

When all the time digits have been set, the **Time** submenu appears. Some digit values are limited to a range of values depending on the field (hour, minutes or seconds).

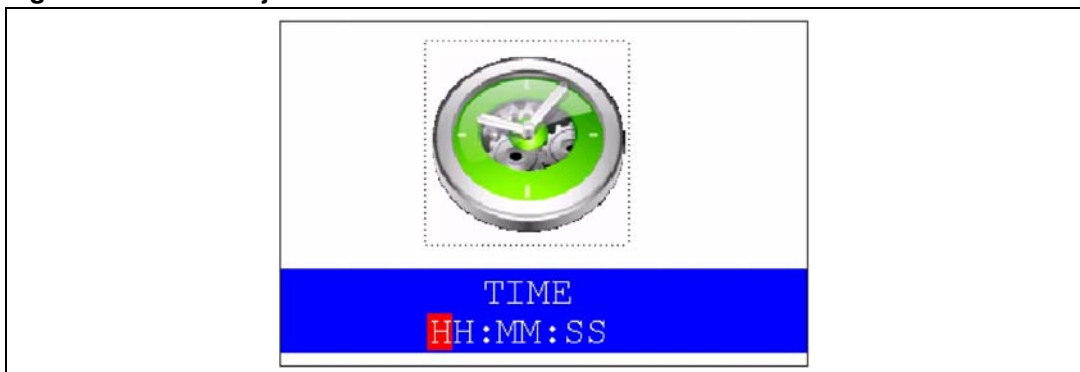
Figure 23. Time Adjust submenu

- **Time Show:** this item displays the current time. If time and date have not been previously configured, a message is displayed, prompting the user to set the time and date or to exit to the upper submenu. When this submenu is selected, the message shown in [Figure 24](#) appears on the LCD. In the example, the time has not been set yet.

Figure 24. Time Show submenu



To exit the **Time Show** submenu, press the SEL push-button. To exit the **Time** submenu, select Return and press the SEL push-button.

Date submenu

This submenu is divided into two items that allow the user to display or set the current date.

- **Date Adjust:** select this item after each power-up in order to set the current date. If the time and date have not been previously configured, a message is displayed, prompting the user to set the time and date or to exit to the upper submenu. The date is displayed as: Year, Month, Week Nbr, Day Nbr (number of the day in the year) with the selected day shown in the month. There is no default date since you have to set the date at least once.

To adjust the date:

1. Start by selecting the year. To select the year, use the UP or DOWN push-button. Pressing the UP push-button displays the current value plus one; pressing the DOWN push-button displays the previous value. To confirm the selected year and continue to the month configuration, press the SEL push-button.

Figure 25. Setting the year

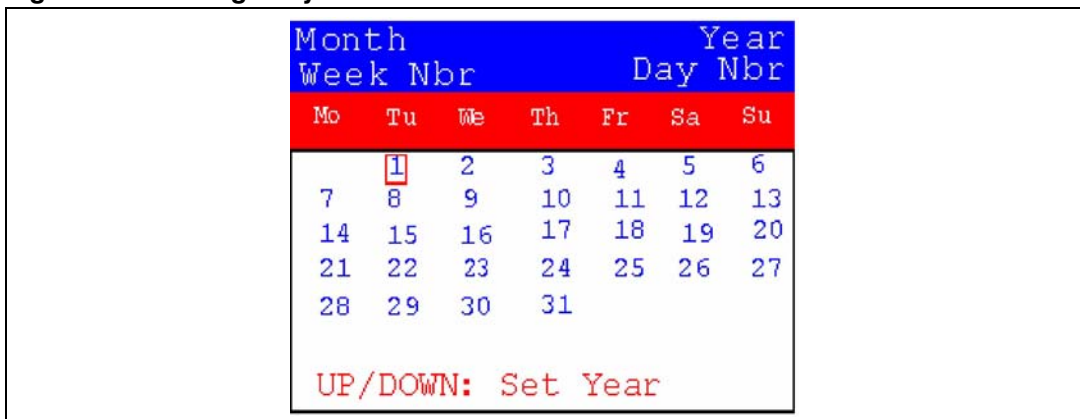

2. Follow the same procedure to select the month and press the SEL push-button to confirm.

Figure 26. Setting the month

Month						Year
Week Nbr						Day Nbr
Mo	Tu	We	Th	Fr	Sa	Su
	1	2	3	4	5	6
7	8	9	10	11	12	13
14	15	16	17	18	19	20
21	22	23	24	25	26	27
28	29	30	31			

UP/DOWN: Set Month

- To select the day, use the UP, DOWN, RIGHT and LEFT push-buttons. After configuring the day, press the SEL push-button to store the entered value and exit to the **Date** submenu.

The current date value is now displayed.

Figure 27. Setting the day of the month

Month						Year
Week Nbr						Day Nbr
Mo	Tu	We	Th	Fr	Sa	Su
	1	2	3	4	5	6
7	8	9	10	11	12	13
14	15	16	17	18	19	20
21	22	23	24	25	26	27
28	29	30	31			

All Key: Set Day

- Date Show:** this item displays the current date. If the time and date have not been previously configured, the message shown in *Figure 28* is displayed. You have the choice to set the time/date or to exit to the upper submenu.

Figure 28. Date Show submenu

Month						Year
Week Nbr						Day Nbr
Mo	Tu	We	Th	Fr	Sa	Su
	1	2	3	4	5	6
7	8	9	10	11	12	13
14	15	16	17	18	19	20
21	22	23	24	25	26	27
28	29	30	31			

To Exit Press SEL

To exit this submenu, press the SEL push-button. To exit the **Date** submenu, select Return and press the SEL push-button.

Alarm submenu

You can use this submenu to configure the alarm activation time. When the alarm time value is reached, all the LEDs (LED1 to LED4) start flashing simultaneously for 30 seconds. This submenu is divided into two items that allow you to display or set the current alarm.

- **Alarm Adjust:** the alarm time activation is set in the same way as in the **Time Adjust** submenu. The following messages are successively displayed on the LCD when this submenu is selected.

Figure 29. Setting the alarm activation time

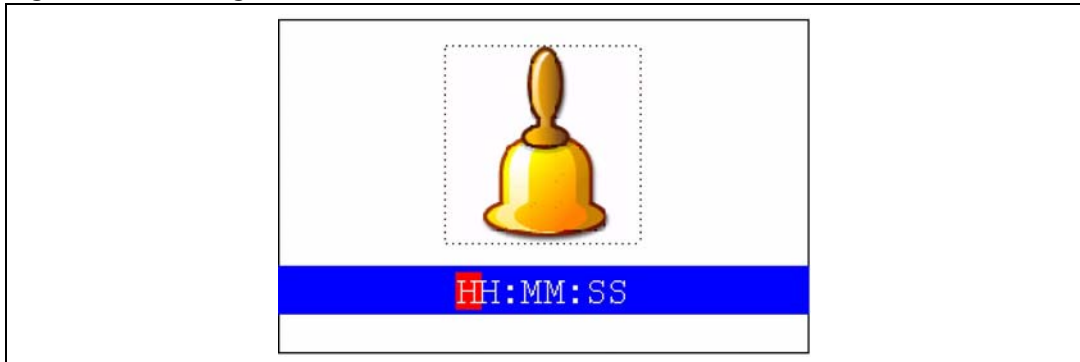

- **Alarm Show:** this item displays the current alarm time. The default alarm activation time displayed after powering up is 00:00:00. The message shown in *Figure 30* is displayed on the LCD when this submenu is selected.

Figure 30. Alarm Show submenu



To exit the **Alarm Show** submenu, press the SEL push-button. To exit the **Alarm** submenu, select Return and press the SEL push-button.

Note: In the **Alarm Adjust** and **Alarm Show** menus, if the time and date have not been previously configured, the message shown in *Figure 31* is displayed on the LCD screen.

Figure 31. Time and date not configured



2.7.3 Image Viewer submenu

The **Image Viewer** submenu is used to demonstrate the LCD control performance using the embedded FSMC interface. The application displays successively the images stored on the MicroSD Card.

This application reads all bitmap pictures from the USER directory (see [Section 4.1: Programming the media files](#)) and displays only the .BMP files having the following format:

- Bit depth: 16 bits (RGB)
- Size: 240x320

The maximum images number that can be read from the MicroSD Card is 25 images selected by alphabetic order.

The **Image Viewer** submenu is shown in [Figure 32](#).

Figure 32. Image Viewer submenu

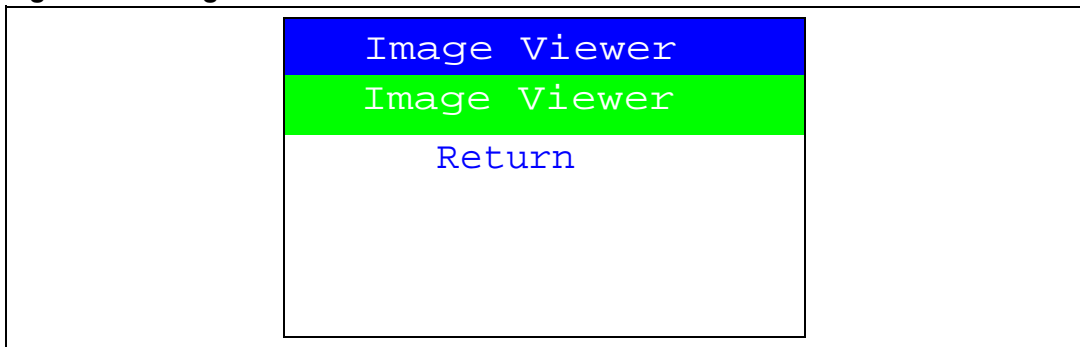

Use RIGHT and LEFT to go to the next/previous image stored in the USER folder of the MicroSD Card. If you press the SEL push-button, the **Image Viewer** is stopped and you return to the **Image Viewer** submenu shown in [Figure 32](#).

2.7.4 Wave Player submenu

The STM32F100ZET6 microcontroller features an embedded DAC which can be used to generate output signals.

In this demonstration, any wave file stored under the USER folder in the MicroSD Card can be opened using the file system DOSFS and transferred to the internal SRAM by block (512 bytes) using the DMA and the SPI interface. Timer 6 (TIM6) triggers the DAC to generate the wave signal. The voice sampling period is read from the Wave File Header. An audio amplifier is connected to the DAC interface to play the stored wave files. This application illustrates all STM32 DAC features and modes using dedicated examples and lists the configuration steps for each mode.

Note: The wave files available in the MicroSD Card are based on free music downloads from the <http://www.danosongs.com> website.

This application reads all wave files from the USER directory (see [Section 4.1: Programming the media files](#)) and displays only the .WAV files having the following format:

- Audio format: PCM (an uncompressed wave data format in which each value represents the amplitude of the signal at the time of sampling)
- Sample rate: may be 8000, 11025, 22050 or 44100 Hz
- Bits per sample: 8 bits (audio sample data values are in the range [0-255])
- Number of channels: 1 (mono) or 2 (stereo)

The **Wave Player** submenu is shown in [Figure 33](#).

Figure 33. Wave Player submenu

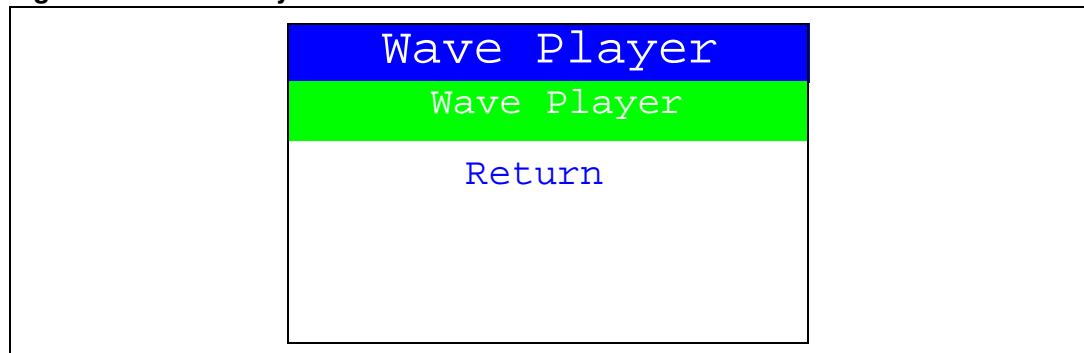

When you select Wave Player, the wave player interface is displayed as shown in [Figure 34](#).

Figure 34. Wave Player interface

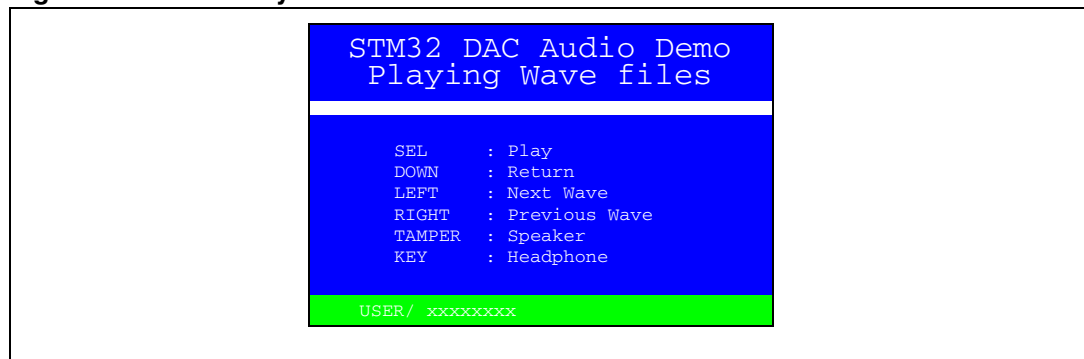

In [Figure 34](#), the active push-buttons and their functions are displayed. For example, at start-up, to play the file through the embedded speaker, press SEL. To exit the **Wave Player** submenu, press DOWN.

The TAMPER push-button is used to select the speaker and the KEY push-button to select the headphone.

Once you select the play command, the submenu shown in [Figure 35](#) is displayed.

Figure 35. Wave Player Playing submenu

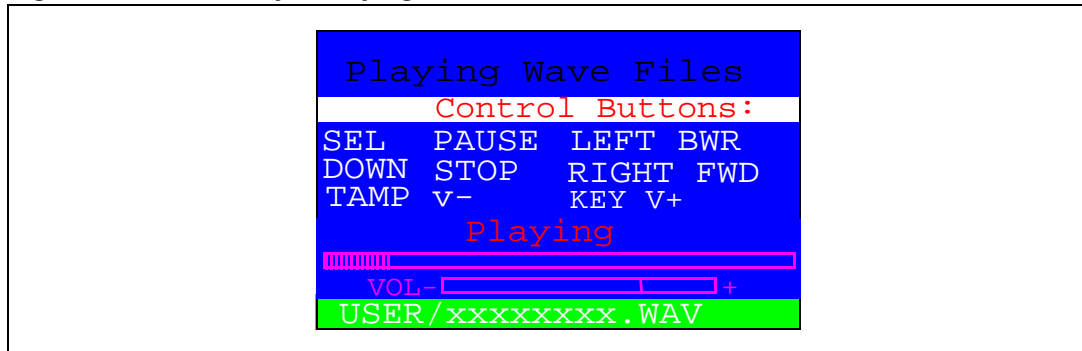

The progress bar and the volume bar are displayed at the bottom of the **Wave Player Playing** submenu. The progress bar is updated about every 1% of the audio file duration and the volume bar is updated each time the volume level is changed.

At this application level:

- Press the SEL push-button to pause the audio stream
- Press the LEFT push-button to decrement the audio stream
- Press the RIGHT push-button to increment the audio stream
- Press the DOWN push-button to exit the **Wave Player** submenu
- Press the TAMPER push-button to decrement the volume level
- Press the KEY push-button to increment the volume level

When the audio stream is paused, the menu in [Figure 36](#) is displayed.

Figure 36. Pause submenu

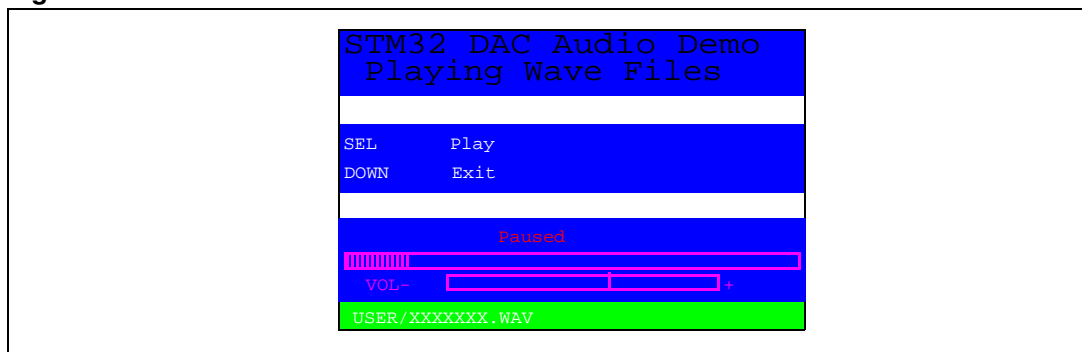

To resume playing, press the SEL push-button to return to the **Wave Player Playing** submenu as shown in [Figure 35](#).

When the audio stream is stopped, the stream position is reset and you return to the Wave Player interface menu shown in [Figure 34](#).

2.7.5 Low power modes

The STM32F100ZET6 microcontroller features several operating modes in which the power consumption is reduced. The purpose of this menu is to demonstrate the behavior of the microcontroller in various low power modes. The Stop and Standby modes are used as examples.

Stop mode menu

This menu allows you to put the STM32F100ZET6 in Stop mode. The software performs the specific instruction sequence required to enter Stop mode.

Figure 37. Stop mode menu



There are two ways to make the STM32F100ZET6 exit Stop mode.

- In the first case, you can use the EXTI Key button. Once the **Stop mode** submenu has been selected, the red LEDs continue blinking until the SEL push-button is pressed, and the system enters Stop mode. When the MCU is in Stop mode, the message shown in [Figure 38](#) is displayed on the LCD.

Figure 38. Stop mode entered

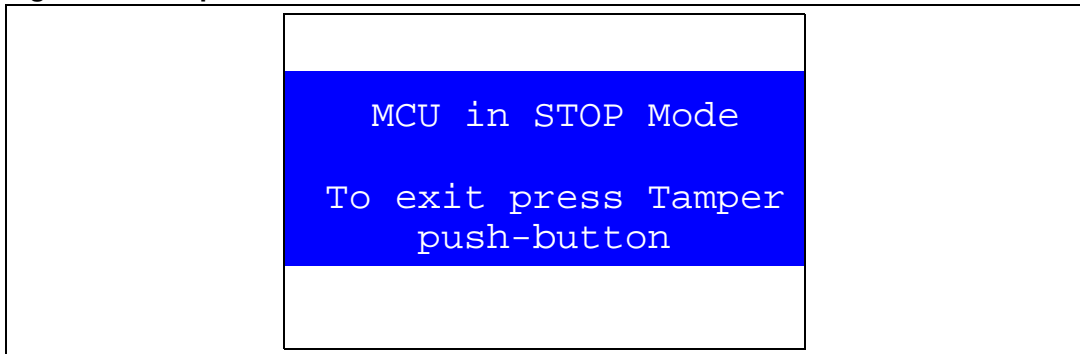

The MCU remains in Stop mode until the TAMPER push-button is pressed as shown in [Figure 39](#). Once you press the TAMPER push-button, the MCU exits Stop mode. The system clock is then set to 24 MHz and the application resumes execution.

Figure 39. MCU in Stop mode

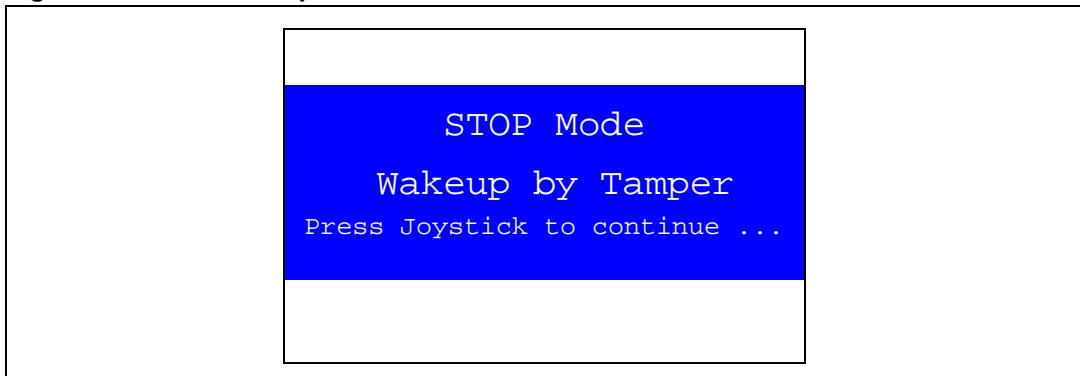

Note: If an RTC Alarm is generated while the MCU is in Stop mode and the message shown in [Figure 39](#) is displayed (which means that the TAMPER push-button needs to be pressed to exit Stop mode), the RTC Alarm wakes up the MCU from Stop mode. The message shown in [Figure 40](#) is then displayed.

Figure 40. RTC Alarm wakes up the MCU from Stop mode

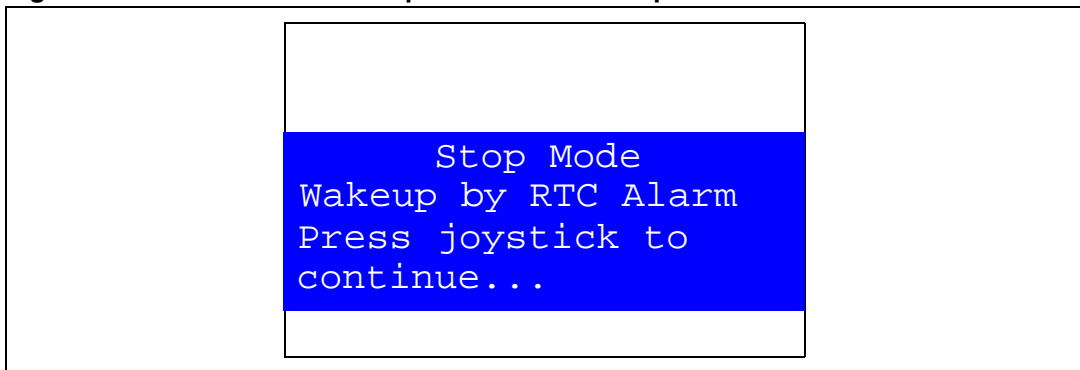

- In the second case, the RTC Alarm wakes up the MCU from Stop mode after the programmed time has elapsed. When selecting this submenu, you have to set the alarm to the time when the MCU is to exit Stop mode. To set the wakeup time, follow the procedure explained in section [Time submenu](#).

Figure 41. Setting the wakeup time

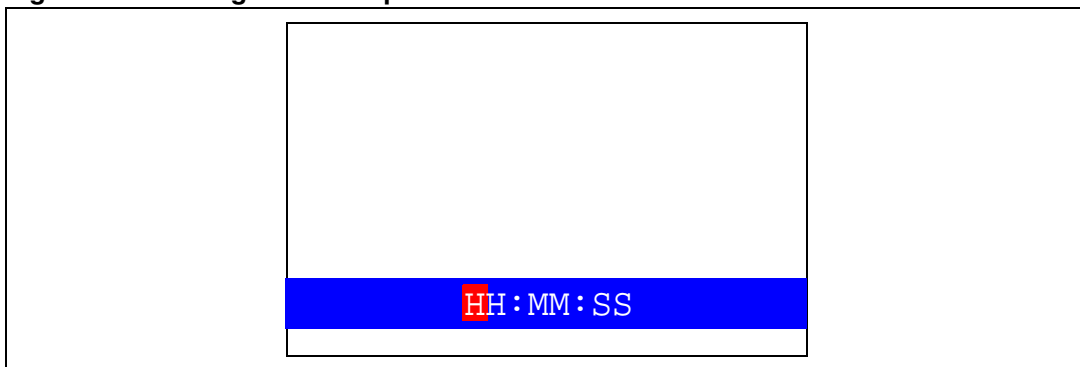

Once the alarm has been configured, the red LEDs stop blinking and the system enters Stop mode. The message shown in [Figure 42](#) is displayed on the LCD.

Figure 42. RTC Alarm wakeup configured

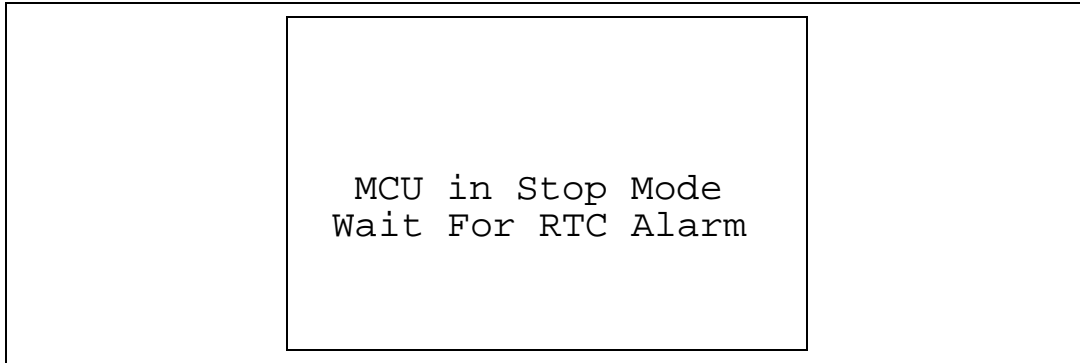

After the programmed time has elapsed, the system exits Stop mode. The system clock is then set to 24 MHz and the application resumes execution. The message shown in [Figure 43](#) is displayed on the LCD screen.

Figure 43. RTC Alarm wakeup

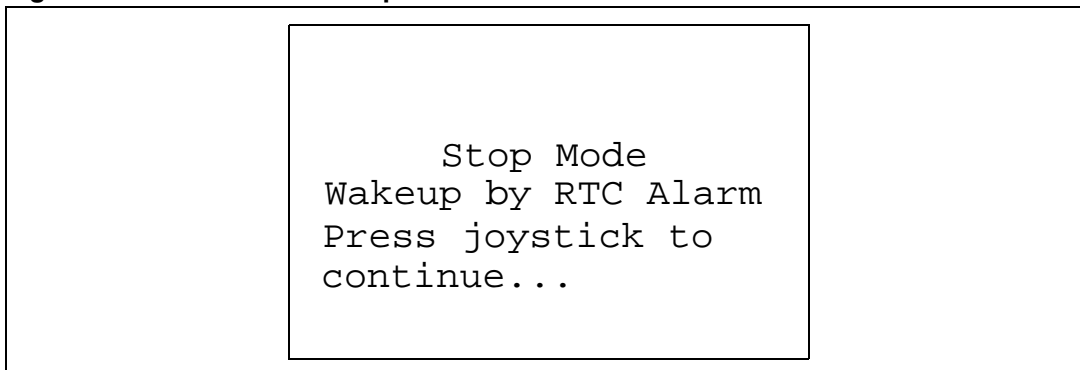

Note: If the time and date have not been set, the message shown in [Figure 44](#) is displayed on the LCD screen.

Figure 44. Time and Date configuration prompt

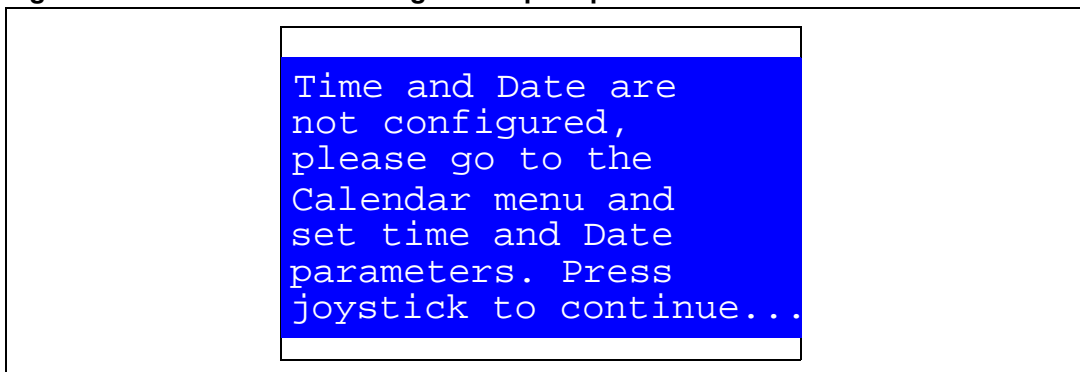

Standby mode menu

This menu allows the user to put the STM32F100ZET6 in Standby mode. The software runs the specific instruction sequence required by the STM32F100ZET6 to enter Standby mode.

Figure 45. Entering Standby mode

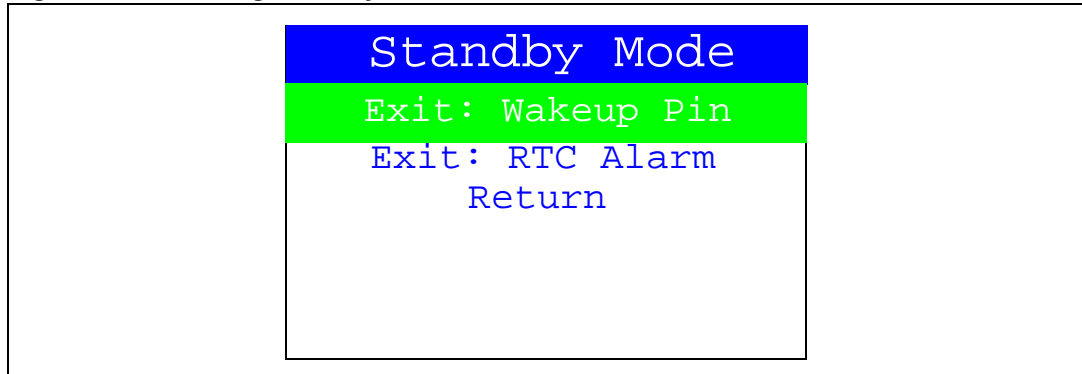

There are two ways to make the STM32F100ZET6 exit Standby mode.

- In the first case, you can use the Wakeup push-button. Once the **Standby mode** submenu has been selected, the red LEDs continue blinking until you press the SEL push-button, and the system enters Standby mode. When the MCU is in Standby mode, the message shown in [Figure 46](#) is displayed on the LCD.

Note: For the first case with WakeUp push-button, check whether the JP4 is in wakeup position.

Figure 46. MCU in Standby mode

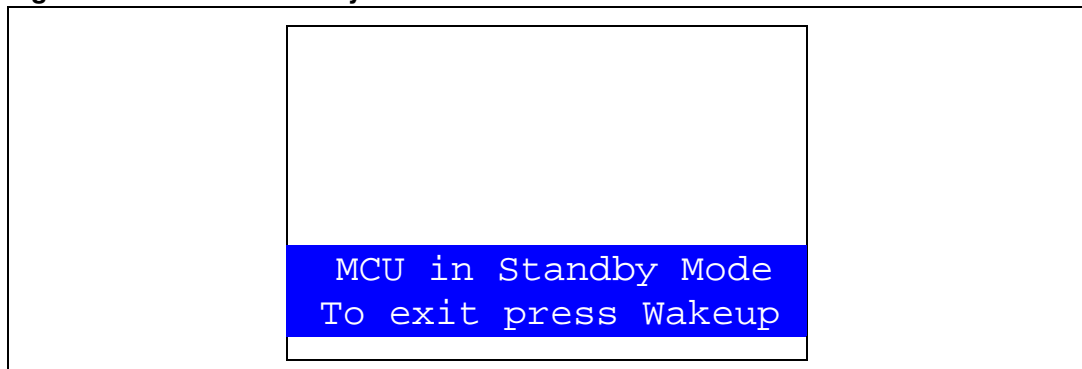

The MCU remains in Standby mode until the Wakeup push-button is pressed. Once you press the Wakeup push-button, the MCU exits Standby mode and the system reset signal is generated.

Note: If an RTC Alarm is generated while the MCU is in Standby mode and the message shown in [Figure 46](#) is displayed (which means that the Wakeup push-button needs to be pressed to exit Standby mode), the RTC Alarm wakes up the MCU from Standby mode and a system reset signal is generated.

- In the second case, the RTC Alarm wakes up the MCU from Standby mode after the programmed time has elapsed. When selecting this submenu, you have to set the alarm to the time when the MCU is to exit Standby mode. To set the wakeup time, follow the procedure explained in the section [Time submenu](#).

Figure 47. Setting the wakeup time

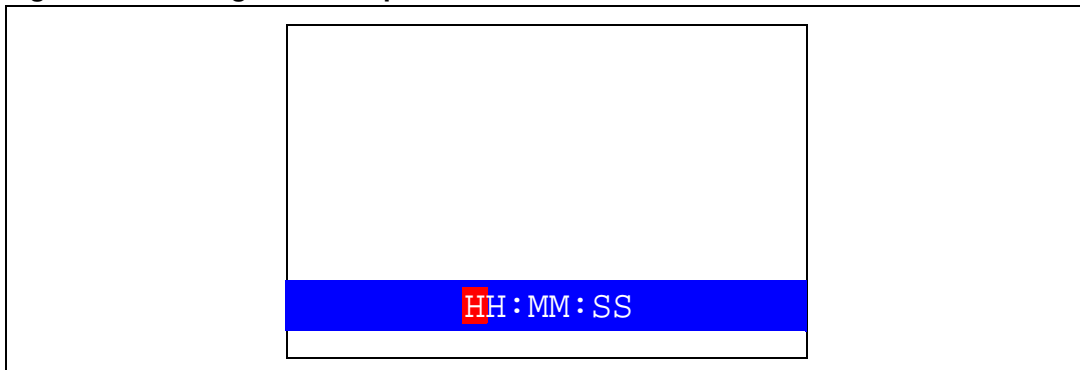

Once the alarm has been configured, the red LEDs stop blinking and the system enters Standby mode. The message shown in [Figure 48](#) is then displayed on the LCD.

Figure 48. RTC Alarm wakeup configured

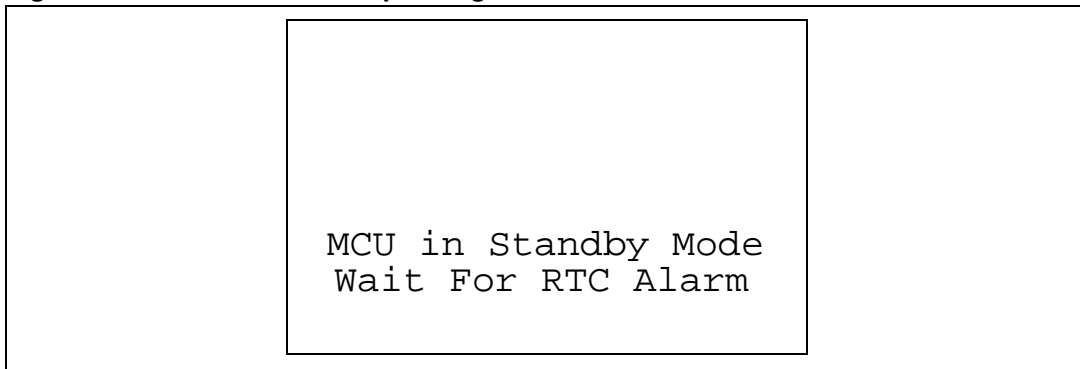

After the programmed timing has elapsed, the system exits Standby mode and a system reset signal is generated.

Note: If the time and date have not been set, the message shown in [Figure 49](#) is displayed on the LCD screen.

Figure 49. Time and Date configuration prompt

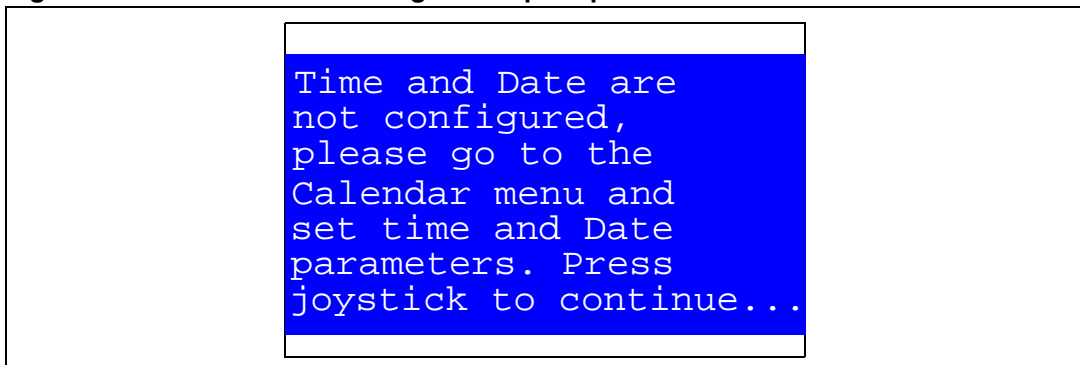

2.7.6 Infrared decoding

The IR receiver TSOP34836 is connected to PC6 of STM32F100ZET6 on the STM32100E-EVAL board.

Note: On STM32100E-EVAL RevA, the IR receiver TSOP34836 is connected to PA11.

To select the **Infrared Decoding** menu, press SEL from the main menu or push on the IR icon. The IR submenu shown in [Figure 50](#) is then displayed on the LCD screen.

Figure 50. Infrared Decoding menu

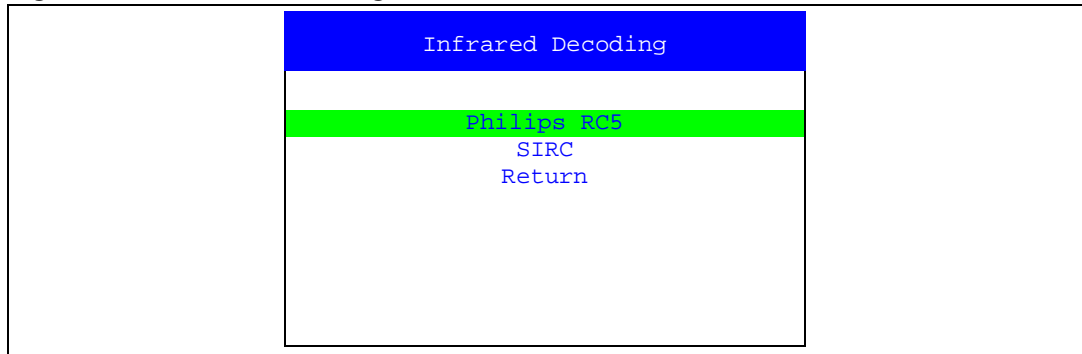

If you select one protocol from the list, the adequate submenu shown in [Figure 51](#) is displayed.

Figure 51. Infrared protocol submenu

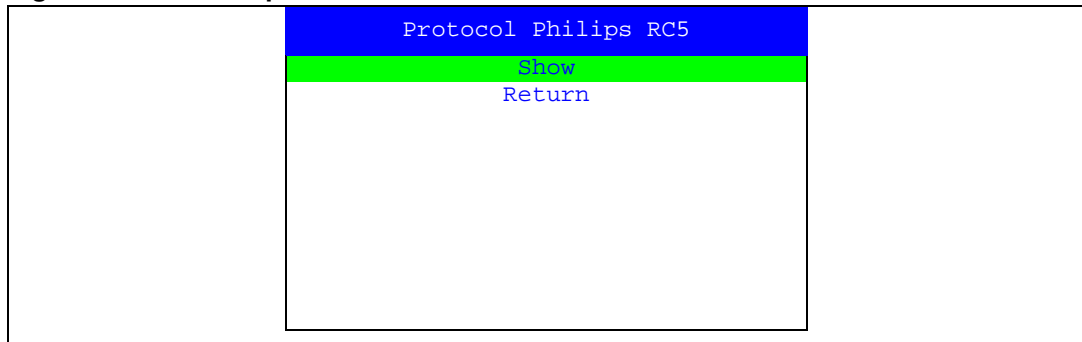

This submenu is divided into two items:

- **Show:** you can use this submenu to display on the LCD the IR frame sent from the remote control.

To exit the infrared protocol submenu, press the SEL push-button. You then return to the Infrared protocol submenu shown in [Figure 51](#).

- **Return:** use this item to return to the infrared decoding menu shown in [Figure 50](#).

Note: For more details, refer to application note AN3174 *Implementing an RC5 infrared remote control receiver with the STM32F10xx microcontrollers*. This application note provides a full description of IR decoding.

2.7.7 Thermometer

The STM32F100ZET6 microcontroller has two embedded I²C peripherals that can be connected to any device supporting the I²C protocol including the System management bus (SMBus) mode. An STLM75 (or a compatible device) I²C temperature sensor is mounted on the STM32100E-EVAL board and used to capture the external temperature (-55°C to +125°C).

When the **Thermometer** submenu is selected, the message shown in *Figure 52* is displayed on the LCD.

Figure 52. Thermometer submenu selected

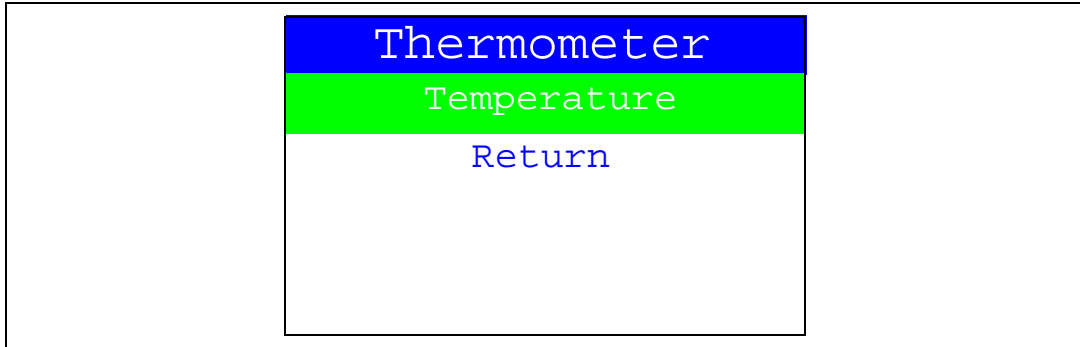

Once you select the **Temperature** submenu, the temperature value is displayed in Celsius and Fahrenheit as shown in *Figure 53*.

Press any key to return to the **Thermometer** submenu.

Figure 53. Temperature display

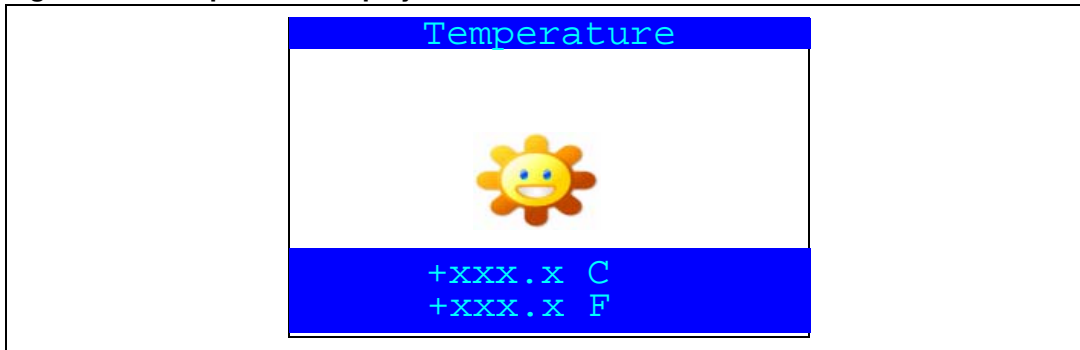

The temperature variations can be monitored easily using the STM32 I2C SMBus feature. This is managed by the SMBus Alert, which generates a dedicated interrupt to inform the system that the temperature is out of the selected range. This can be very useful for systems where the increase of temperature needs an immediate intervention, like in motor control, medical systems, etc.

If the temperature exceeds the over-limit high value (TEMPERATURE_TOS: Over Limit Temperature), the SMBus Alert interrupt is generated and the following warning message is displayed on the LCD screen:

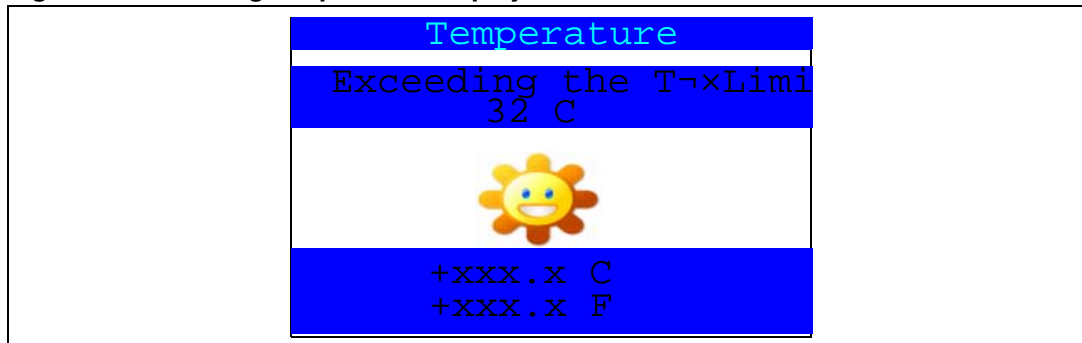
Figure 54. Warning temperature display

The message shown in [Figure 54](#) is displayed on the LCD when the temperature goes under the over-limit low value (TEMPERATURE_THYS: Hysteresis Temperature).

You can configure the TOS and THYS using dedicated `#define` statements in the code. By default, they are set to (see `menu.c` file):

```
#define TEMPERATURE_THYS 31
#define TEMPERATURE_TOS 32
```

Press any key to return to the **Thermometer** submenu.

Note: Any hardware trouble with the temperature sensor is detected by a test. In such case, the message shown in [Figure 55](#) is displayed.

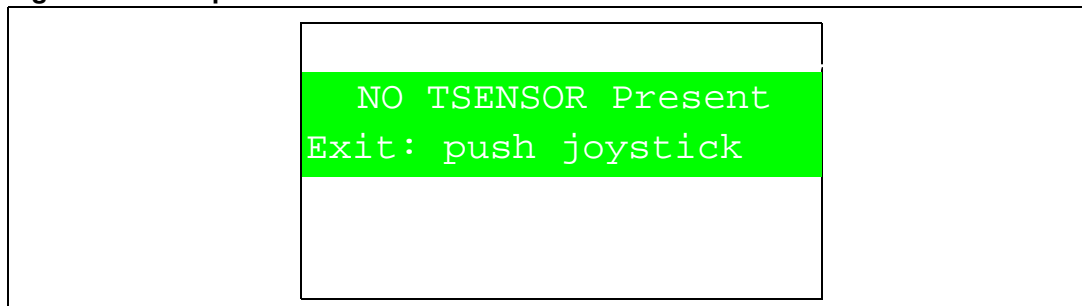
Figure 55. Temperature sensor error

2.7.8 HDMI™ CEC submenu

The STM32F100ZET6 microcontroller features an HDMI-CEC peripheral. This demonstration shows how to configure this peripheral and how to create a CEC network providing a high-level communication between various devices using CEC protocol messages.

For more details, refer to application note AN3127 *CEC networking using STM32F100xx value line microcontrollers*. This application note provides a full description of the STM32F100xx value line embedded HDMI-CEC Controller, and a step-by-step firmware description of CEC peripheral configuration. An advanced demonstration firmware communicating in a real multimedia and HDMI environment is also provided to help build the CEC applications.

When the **HDMI CEC** submenu is selected, the message shown in [Figure 56](#) is displayed on the LCD.

Figure 56. HDMI CEC submenu selected

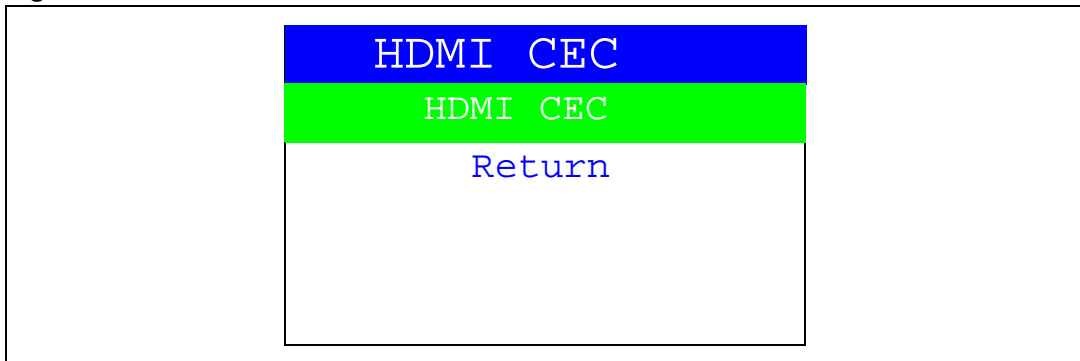

Once you select the **HDMI CEC** submenu, if no CEC error is generated, the device is configured as Tuner and the physical and logical addresses are displayed on the LCD as shown in *Figure 57*. To enter the CEC menu, press the SEL push-button.

Figure 57. HDMI CEC configuration submenu

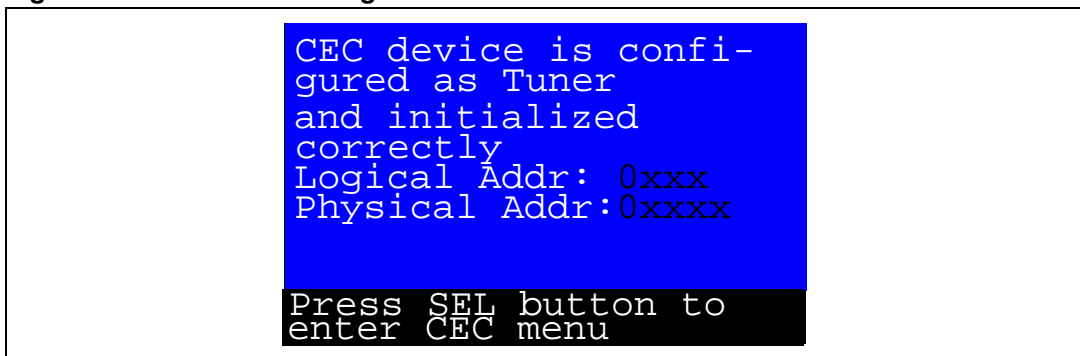

The LCD screen is divided into two parts as shown in *Figure 58*:

- a subscreen that shows the CEC receive information: receive status, sender address
- a subscreen prompting you to select the follower address and the command to send

Figure 58. CEC menu



After selecting the follower address, select the command to be sent to that address using the LEFT, RIGHT and SEL push-buttons. After selecting the command, the CEC device sends this command to the address and displays the status of transmission as shown in *Figure 59*.

The feature CEC device also allows the user to command and control multiple audiovisual devices with one infrared remote control. After selecting the address, the user presses on the remote control and a command is sent by the CEC device. The message is displayed in the receiver field.

To change the address selected, press on the KEY button and the message in [Figure 58](#) will be shown.

- Note:*
- 1 Only the protocol Philips RC5 was integrated in the HDMI-CEC application. Each RC5 command has a corresponding HDMI-CEC User Control Code.
 - 2 For more details, refer to application note AN3174 Implementing an RC5 infrared remote control receiver with the STM32F10xx microcontrollers. This application note provides a full description of IR decoding.

You can select again a new follower address and a new command.

Figure 59. Select CEC command

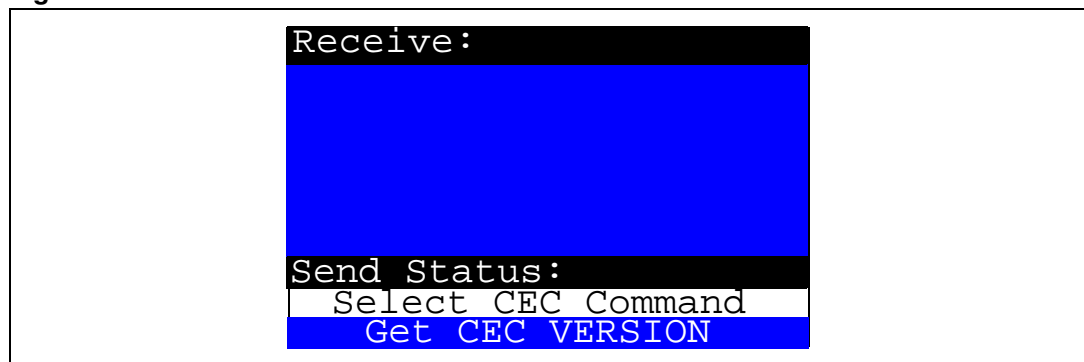

When receiving a new message, the following information can be displayed on the LCD:

- Receive status
- Sender address
- Number of bytes (including the sender's address)
- Opcode message
- Data (operands)

[Figure 60](#) shows that the device has correctly received the frame from the sender with address: 0x5, number of bytes received: 0x3 (header + opcode + data), message opcode: 0x44 and data: 0x41.

Figure 60. Receive subscreen information

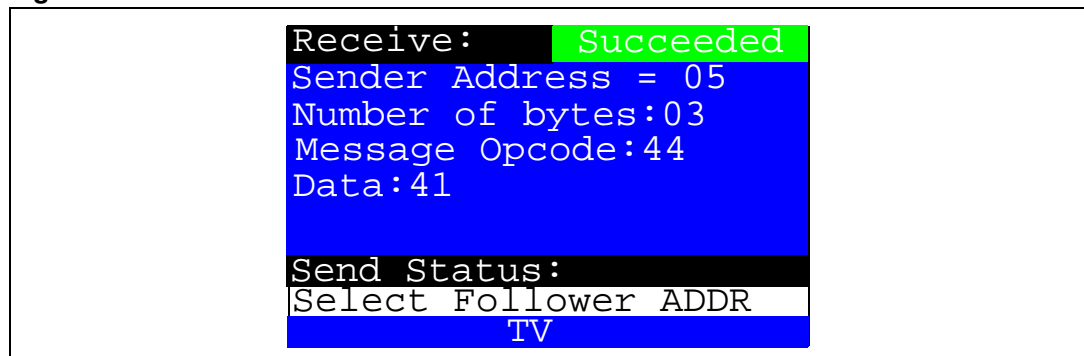

Normally, for the Standby command, the device is in Stop mode and can wake up only when it receives a new command. However, you can use the TAMPER push-button to exit the HDMI-CEC submenu in case the demonstration is blocked.

Any time in the CEC application, if you press the TAMPER push-button, the HDMI CEC stops and you return to the HDMI CEC submenu shown in [Figure 56](#).

Note: The STM32100E CEC device responds only to the following commands. To other commands, it sends a feature abort.

- Standby
- Get CEC version
- Give physical address
- Give OSD name

2.7.9 Help submenu

This submenu provides help on the various keys used in the STM32F100ZET6 demonstration. When this submenu is selected, the message shown in [Figure 61](#) is displayed on the LCD screen.

Figure 61. Help submenu

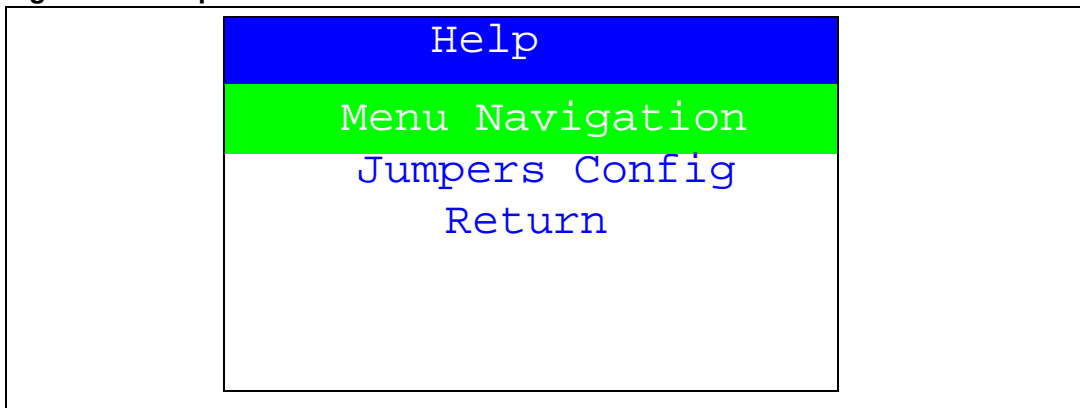

If the user chooses the menu navigation, the image shown in [Figure 62](#) is displayed on the LCD screen.

Figure 62. Joystick push-buttons

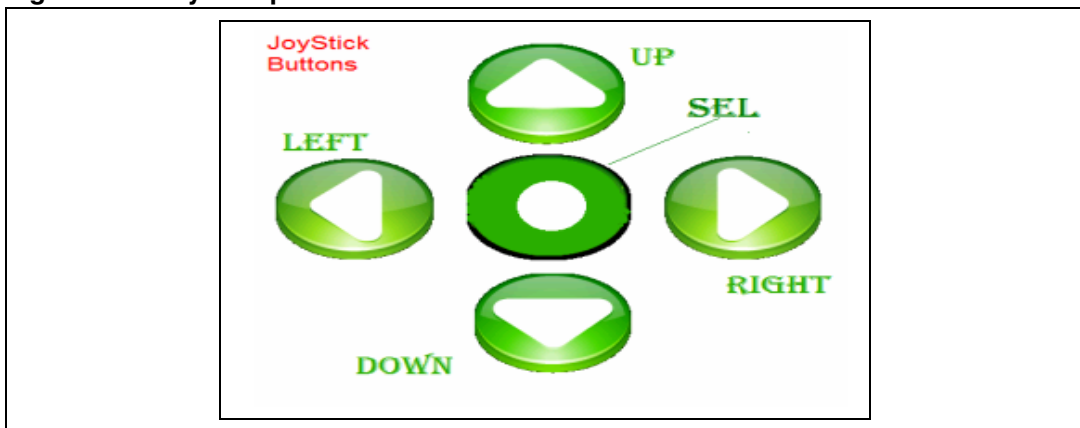

Press any joystick push-button to display the next help slide as shown in [Figure 63](#).

Figure 63. Second Help slide

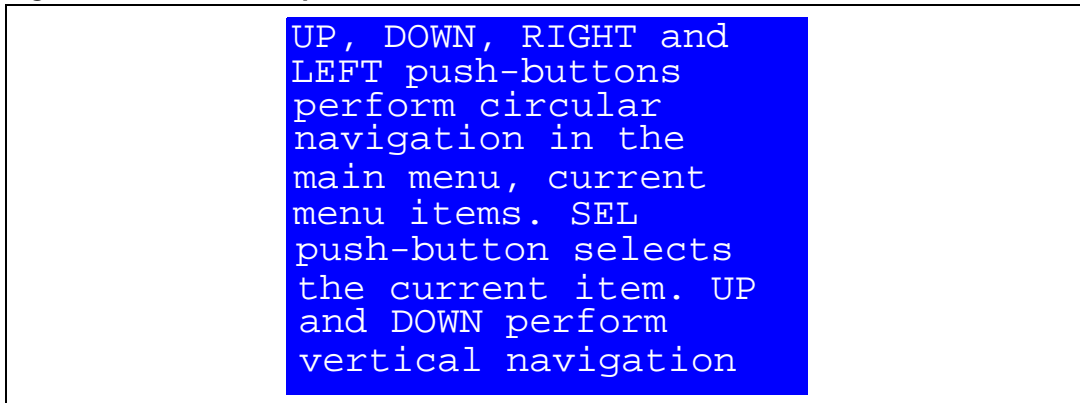

Press the joystick to exit the slide and return to the **Help** submenu ([Figure 61](#)).

If you choose Jumpers config, a list of jumpers to be configured for the demonstration is displayed on the LCD screen. Use Right and Left to go to the next jumper configuration. If you press the Down push-button, you return to the **Help** submenu.

2.7.10 About submenu

This submenu shows the version of the STM32F100ZET6 demonstration software. When the **About** submenu is selected, the message shown in [Figure 64](#) is displayed on the LCD screen.

Figure 64. About submenu

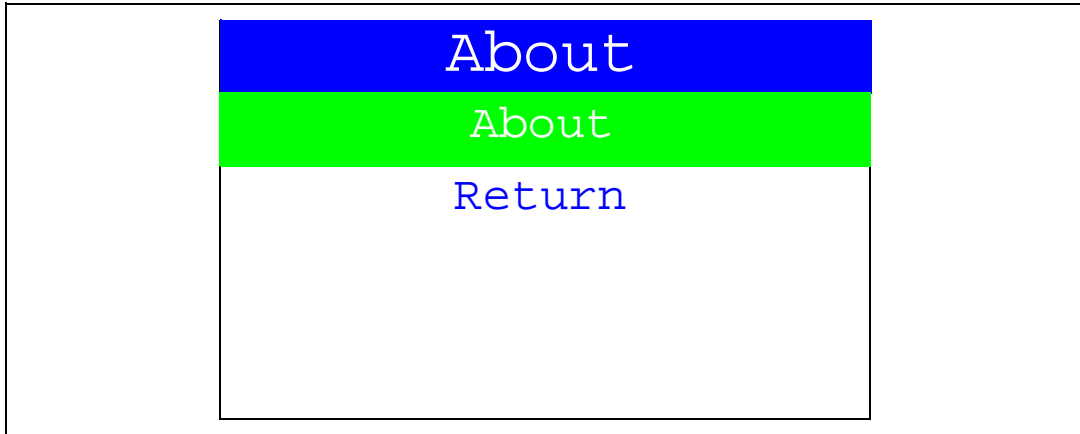

Press SEL to display a message showing the STM32100E-EVAL demonstration version on the LCD screen.

3 STM32100E-EVAL demonstration package

The STM32100E-EVAL demonstration is supplied in one single zip file. The extraction of the zip file generates one folder, *STM32100E-EVAL_FW_VX.Y.Z*, which contains the subfolders shown in [Figure 65](#) and described below.

Figure 65. STM32100E-EVAL demonstration package directory tree

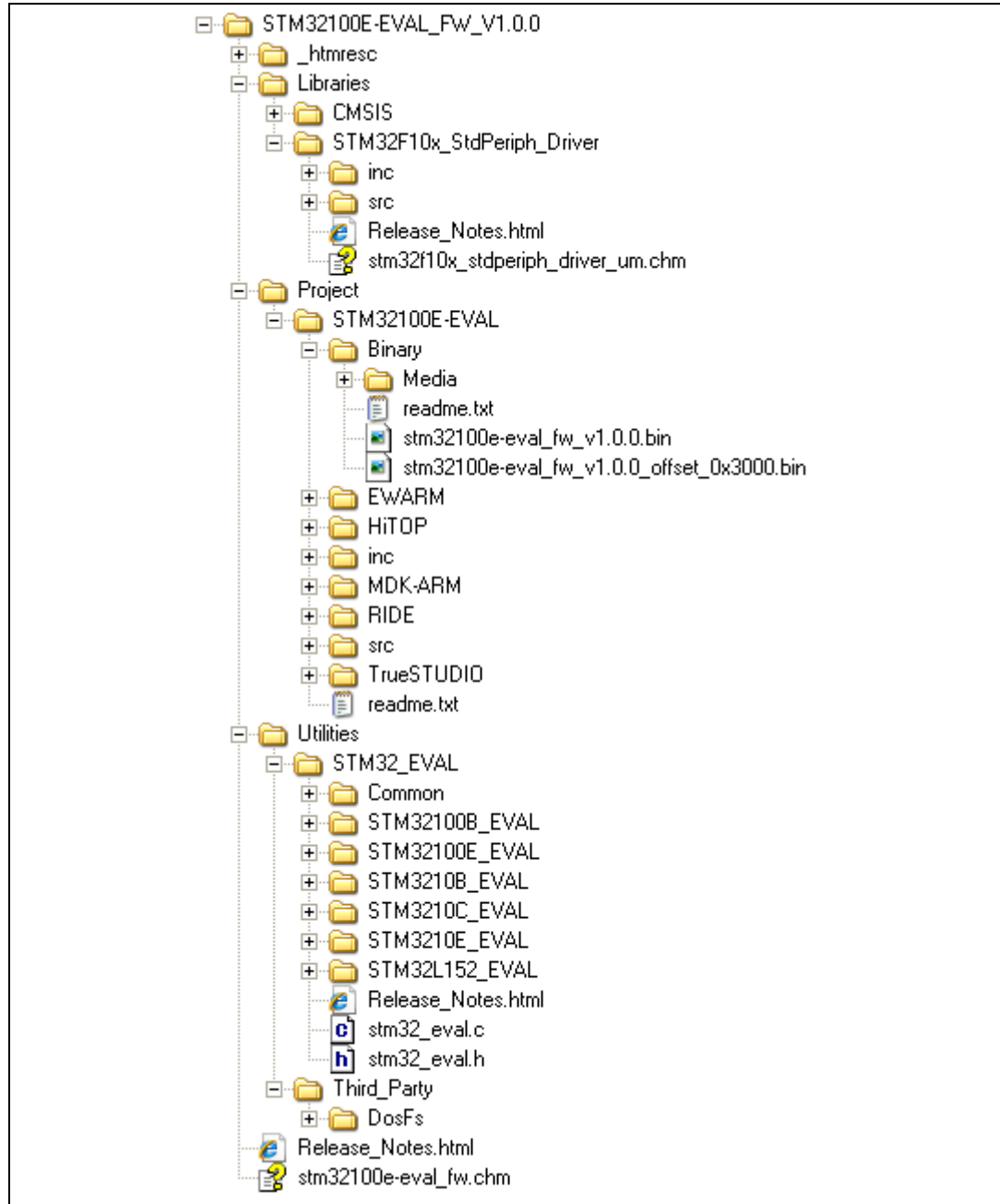

3.1 Libraries

The **Libraries** folder contains all the subdirectories and files that make up the core of the STM32F10xxx Standard Peripheral library Vx.Y.Z:

- **CMSIS**
 - **CM3\CoreSupport**: contains the Cortex-M3 files
 - **CM3\DeviceSupport\ST\STM32F10x**: contains the STM32F10x CMSIS layers files
- **STM32F10x_StdPeriph_Driver**
 - **inc** subfolder: contains the Standard Peripheral library header files
 - **src** subfolder: contains the Standard Peripheral library source files

3.2 Project

STM32100E-EVAL

- **Binary**: contains the binary image of the demonstration that can be used to program the binary image to the internal Flash memory using IAP, plus the Media files required to run the demonstration (Binary\Media).
- **EWARM**: contains preconfigured projects for the EWARM toolchain
- **MDK-ARM**: contains preconfigured projects for the MDK-ARM toolchain
- **HiTOP**: contains preconfigured projects for the HiTOP toolchain
- **inc** subfolder: contains the demonstration header files
- **src** subfolder: contains the demonstration source files
- **RIDE**: contains preconfigured projects for the RIDE toolchain
- **TrueSTUDIO**: contains preconfigured projects for the TrueSTUDIO toolchain

3.3 Utilities

STM32100E-EVAL: contains the LCD, and other STM32100E-EVAL board-related drivers.

4 STM32100E-EVAL demonstration programming

4.1 Programming the media files

The STM32100E-EVAL board comes with a MicroSD Card memory preprogrammed with the audio and image resources used by the demonstration. However, you can load your own image (*.bmp) and audio (*.wav) files in the USER directory, providing that these file formats are supported by the demonstration. For more details, refer to [Section 2.7.4: Wave Player submenu](#) and [Section 2.7.3: Image Viewer submenu](#).

Figure 66. SD Card directory organization

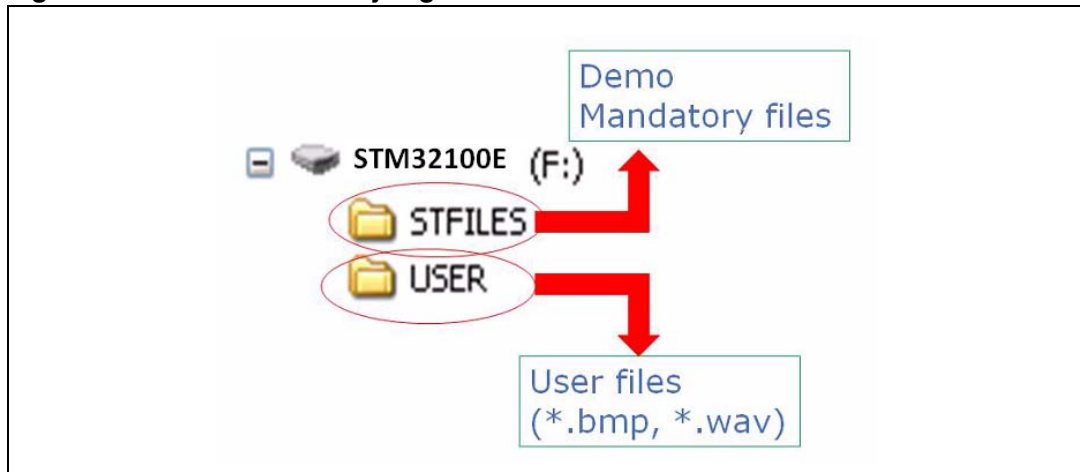

The default content of the media files (STFILES and USER directories) can be retrieved from Binary\Media folder. So, if you want to reprogram the MicroSD Card, you can copy the content of the Binary\Media to your own SD memory.

4.2 Programming the demonstration

You can program the demonstration using three methods:

Using the Bootloader

To program the demonstration binary images into the internal Flash memory, you have to use the stm32100e_eval_fw_v1.0.0.bin file located under Project\STM32100E-EVAL\Binary with embedded Bootloader. For more details, please refer to application note AN2606 *STM32™ microcontroller system memory boot mode*.

Using preconfigured projects

1. Select the folder corresponding to your preferred toolchain (MDK-ARM, EWARM, HiTOP, RIDE or TrueSTUDIO).
2. Open the STM32100E_EVAL_Demo project and rebuild all sources.
3. Load the project image through your debugger.
4. Restart the evaluation board (press B1: reset button).

4.2.1 Using IAP

To program the demonstration's binary image into the internal Flash memory, you have to use the `stm32100e-eval_fw_Usv1.0.0_offset_0x3000.bin` file located under `Project\STM32100E-EVAL\Binary with IAP over USART`. For more details, please refer to IAP application note *AN2557 STM32F10x in-application programming using the USART*.

5 Revision history

Table 4. Document revision history

Date	Revision	Changes
14-Apr-2011	1	Initial release.

Please Read Carefully:

Information in this document is provided solely in connection with ST products. STMicroelectronics NV and its subsidiaries ("ST") reserve the right to make changes, corrections, modifications or improvements, to this document, and the products and services described herein at any time, without notice.

All ST products are sold pursuant to ST's terms and conditions of sale.

Purchasers are solely responsible for the choice, selection and use of the ST products and services described herein, and ST assumes no liability whatsoever relating to the choice, selection or use of the ST products and services described herein.

No license, express or implied, by estoppel or otherwise, to any intellectual property rights is granted under this document. If any part of this document refers to any third party products or services it shall not be deemed a license grant by ST for the use of such third party products or services, or any intellectual property contained therein or considered as a warranty covering the use in any manner whatsoever of such third party products or services or any intellectual property contained therein.

UNLESS OTHERWISE SET FORTH IN ST'S TERMS AND CONDITIONS OF SALE ST DISCLAIMS ANY EXPRESS OR IMPLIED WARRANTY WITH RESPECT TO THE USE AND/OR SALE OF ST PRODUCTS INCLUDING WITHOUT LIMITATION IMPLIED WARRANTIES OF MERCHANTABILITY, FITNESS FOR A PARTICULAR PURPOSE (AND THEIR EQUIVALENTS UNDER THE LAWS OF ANY JURISDICTION), OR INFRINGEMENT OF ANY PATENT, COPYRIGHT OR OTHER INTELLECTUAL PROPERTY RIGHT.

UNLESS EXPRESSLY APPROVED IN WRITING BY AN AUTHORIZED ST REPRESENTATIVE, ST PRODUCTS ARE NOT RECOMMENDED, AUTHORIZED OR WARRANTED FOR USE IN MILITARY, AIR CRAFT, SPACE, LIFE SAVING, OR LIFE SUSTAINING APPLICATIONS, NOR IN PRODUCTS OR SYSTEMS WHERE FAILURE OR MALFUNCTION MAY RESULT IN PERSONAL INJURY, DEATH, OR SEVERE PROPERTY OR ENVIRONMENTAL DAMAGE. ST PRODUCTS WHICH ARE NOT SPECIFIED AS "AUTOMOTIVE GRADE" MAY ONLY BE USED IN AUTOMOTIVE APPLICATIONS AT USER'S OWN RISK.

Resale of ST products with provisions different from the statements and/or technical features set forth in this document shall immediately void any warranty granted by ST for the ST product or service described herein and shall not create or extend in any manner whatsoever, any liability of ST.

ST and the ST logo are trademarks or registered trademarks of ST in various countries.

Information in this document supersedes and replaces all information previously supplied.

The ST logo is a registered trademark of STMicroelectronics. All other names are the property of their respective owners.

© 2011 STMicroelectronics - All rights reserved

STMicroelectronics group of companies

Australia - Belgium - Brazil - Canada - China - Czech Republic - Finland - France - Germany - Hong Kong - India - Israel - Italy - Japan - Malaysia - Malta - Morocco - Philippines - Singapore - Spain - Sweden - Switzerland - United Kingdom - United States of America

www.st.com