

GPS+GSM Combination Antenna **JCB057**

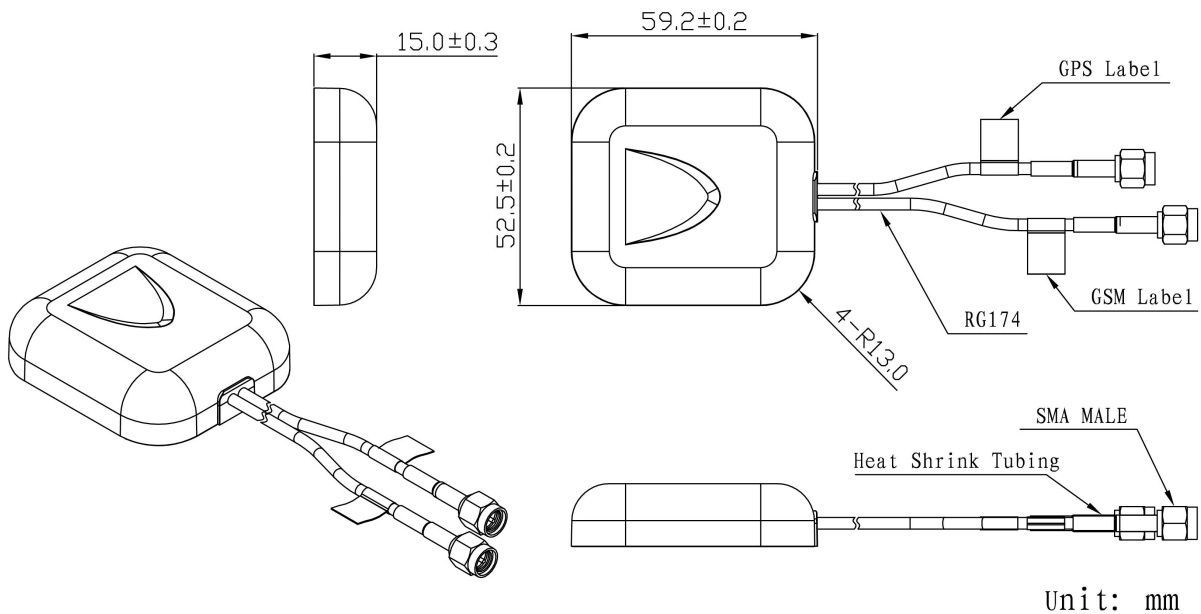

DIMENSIONS



SPECIFICATIONS

| Item | | Specifications | |
|---------------|--------------------------|--|-----------------------------|
| GPS Antenna | Dielectric Antenna | Center Frequency | 1575.42±1MHz |
| | | Band Width | CF±5MHz |
| | | Polarization | RHCP |
| | | Gain | 2dBic (Zenith) |
| | | V.S.W.R | <1.5 |
| | | Impedance | 50Ω |
| | | Axial Ratio | 3dB (max) |
| | LNA | Gain | 28±2dB |
| | | Noise Figure | <1.5 |
| | | Ex-band Attenuation | 12dB@CF+50MHz/16dB@CF-50MHz |
| | | V.S.W.R | <2.0 |
| | | Supply Voltage | 2.2~5V DC |
| | Current Consumption | 5~15mA | |
| GSM Antenna | Frequency Range | 824~960MHz/1710~2170MHz | |
| | V.S.W.R (min) | <2.5 | |
| | Polarization | Linear | |
| | Gain | 2dBi | |
| | Impedance | 50Ω | |
| Mechanical | Cable | RG174 | |
| | Connector | SMA/MCX/FAKRA or others | |
| | Radome Material | ABS | |
| | Mounting Method | Magnet/Adhesive | |
| Environmental | Operating Temperature | -40℃~+85℃ | |
| | Relative Humidity | Up to 95% | |
| | Ingress Protection | IP65~IP67 | |
| | Vibration | 10 to 55Hz with 1.5mm amplitude 2hours | |
| | Environmentally Friendly | ROHS Compliant | |

Radiation Pattern

GPS Antenna

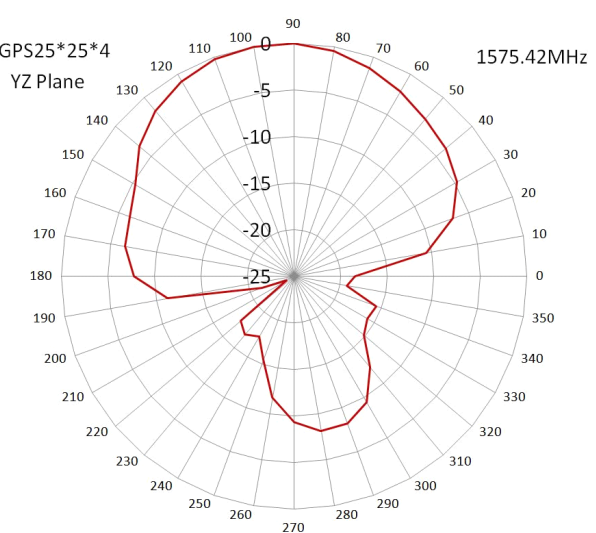
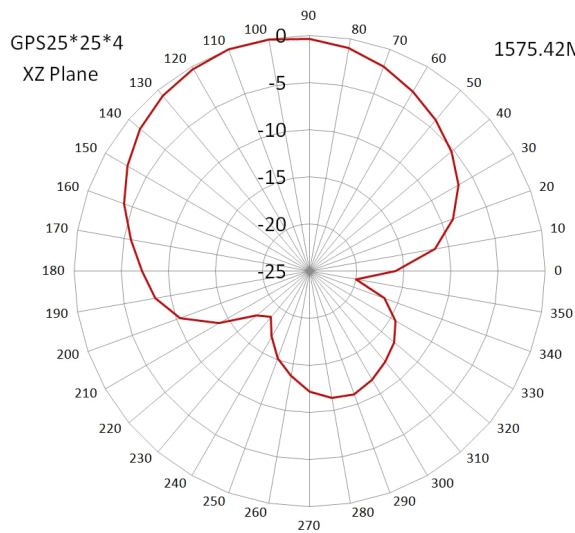
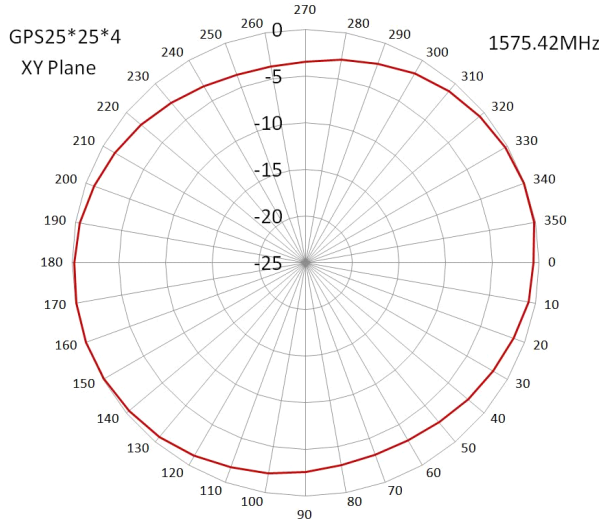

GSM Antenna

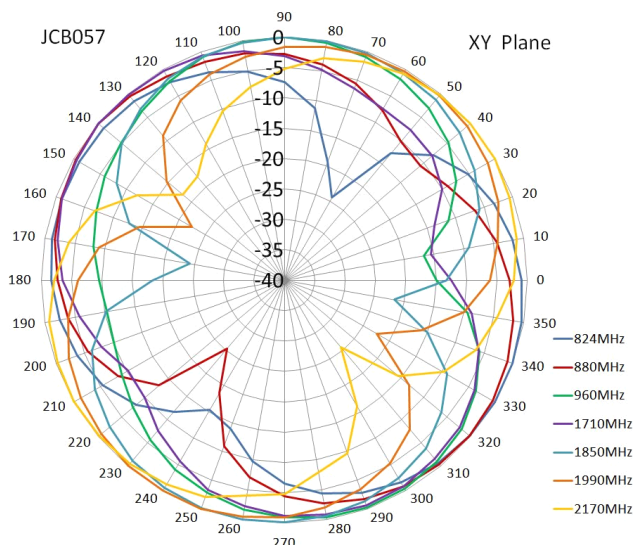

JIAXING JINCHANG ELECTRONIC TECHNOLOGY CO.,LTD

Add: 398#, Zhenye Road, South Street, Jiaxing, Zhejiang, China

Http:// www.jinchanggps.com

E-mail:jcgps@vip.163.com

Tel: 86-0573-83692157/83692605/83958637 Fax:86-0573-83958635



Jinchang Electron Global Service

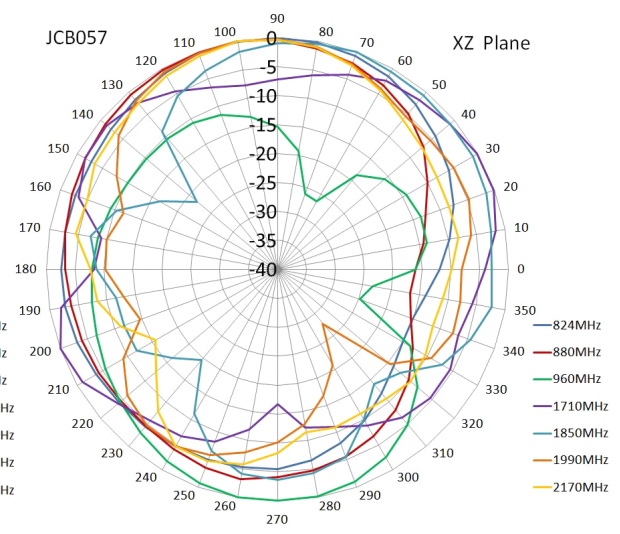
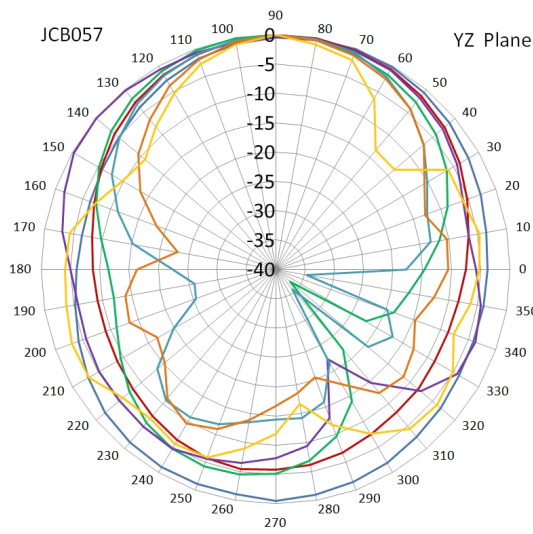

JIAXING JINCHANG ELECTRONIC TECHNOLOGY CO.,LTD

Add: 398#, Zhenye Road, South Street, Jiaxing, Zhejiang, China

Http:// www.jinchanggps.com

E-mail: jcgps@vip.163.com

Tel: 86-0573-83692157/83692605/83958637 Fax: 86-0573-83958635