

THIS DOCUMENT IS THE PROPERTY OF
KEYSTONE ELECTRONICS CORP. AND
SHALL NOT BE REPRODUCED, DISTRIBUTED
OR USED AS A BASIS FOR MANUFACTURE
WITHOUT PRIOR WRITTEN PERMISSION
FROM KEYSTONE ELECTRONICS CORP.

SCHEMATIC

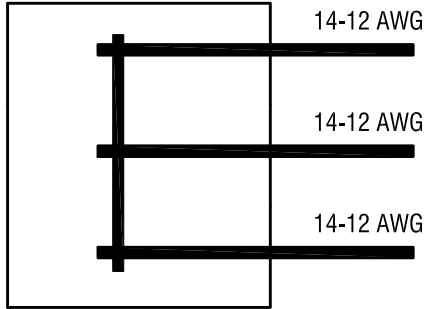

ACTUAL SIZE:

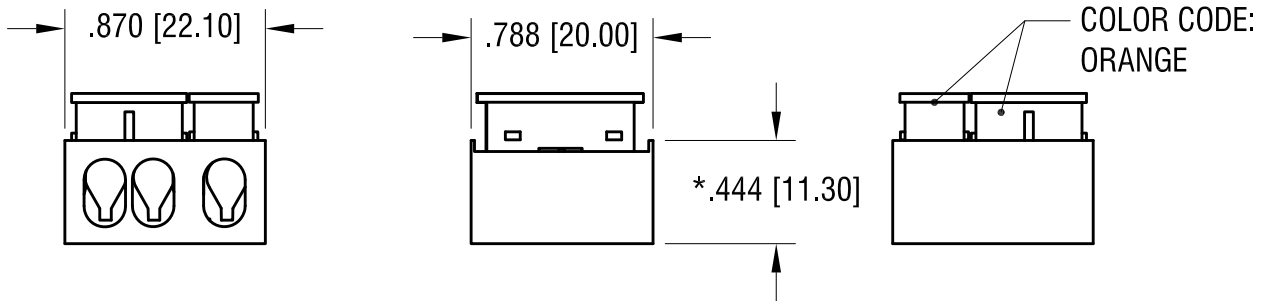
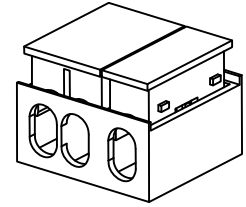

NOTE:

1. 3 PIN ONE WAY SERIES
2. INSULATION: MAT'L- POLYCARBONATE, LEXAN UL 94V-0
3. CONTACT: MAT'L- COPPER ALLOY
FINISH- TIN PLATE, OVER NICKEL PLATE
4. FOR WIRE: SOLID WIRE
WIRE SIZE: 14 AWG MIN. - 12 AWG MAX.
5. RATED VOLTAGE 300V
RATED CURRENT: 25 A

* HEIGHT OF CLOSED CONNECTOR

10.13.22 PARTS ARE NO LONGER UL LISTED
CHANGE AS PER ECN 22-158

A
REV.

KEYSTONE ELECTRONICS CORP.			
www.keyelco.com • NEW HYDE PARK, NY 11040 • Tel (516) 328-7500			
PART NAME			
ONE WAY SERIES WIRE CONNECTOR			
MATERIAL			
AS NOTED			
FINISH		DRN BY	DATE
AS NOTED		NT	1.06.17
		APP'D	SCALE
		RH	1.2X
TOLERANCES	INCH [MM]	CODE	DWG NO.
DECIMAL	± .010 [± 0.25]	C	8375
ANGULAR	± 1°		
UNLESS OTHERWISE SPECIFIED			