

ISL9V3040D3STV

ECOSPARK[®] Ignition IGBT

300 mJ, 400 V, N-Channel Ignition IGBT

Features

- SCIS Energy = 300 mJ at $T_J = 25^\circ\text{C}$
- Logic Level Gate Drive
- This Device is Pb-Free and is RoHS Compliant
- AEC-Q101 Qualified and PPAP Capable

Applications

- Automotive Ignition Coil Driver Circuits
- High Current Ignition System
- Coil on Plug Applications

MAXIMUM RATINGS ($T_J = 25^\circ\text{C}$ Unless Otherwise Stated)

Parameter	Symbol	Value	Units
Collector to Emitter Breakdown Voltage ($I_C = 1\text{ mA}$)	BV_{CER}	400	V
Emitter to Collector Voltage – Reverse Battery Condition ($I_C = 10\text{ mA}$)	BV_{ECS}	24	V
ISCIS = 14.2 A, L = 3.0 mHz, $R_{GE} = 1\text{ K}\Omega$ (Note 1), $T_C = 25^\circ\text{C}$	E_{SCIS25}	300	mJ
ISCIS = 10.6 A, L = 3.0 mHz, $R_{GE} = 1\text{ K}\Omega$ (Note 2), $T_C = 150^\circ\text{C}$	$E_{SCIS150}$	170	mJ
Collector Current Continuous, at $V_{GE} = 4.0\text{ V}$, $T_C = 25^\circ\text{C}$	I_{C25}	21	A
Collector Current Continuous, at $V_{GE} = 4.0\text{ V}$, $T_C = 110^\circ\text{C}$	I_{C110}	17	A
Gate to Emitter Voltage Continuous	V_{GEM}	± 10	V
Power Dissipation Total, $T_C = 25^\circ\text{C}$	PD	150	W
Power Dissipation Derating, $T_C > 25^\circ\text{C}$	PD	1	W/ $^\circ\text{C}$
Operating Junction and Storage Temperature	T_J, T_{STG}	-55 to 175	$^\circ\text{C}$
Lead Temperature for Soldering Purposes (1/8" from case for 10 s)	T_L	300	$^\circ\text{C}$
Reflow soldering according to JESD020C	T_{PKG}	260	$^\circ\text{C}$
HBM-Electrostatic Discharge Voltage at 100 pF, 1500 Ω	ESD	4	kV
CDM-Electrostatic Discharge Voltage at 1 Ω	ESD	2	kV

Stresses exceeding those listed in the Maximum Ratings table may damage the device. If any of these limits are exceeded, device functionality should not be assumed, damage may occur and reliability may be affected.

1. Self Clamped inductive Switching Energy (E_{SCIS25}) of 300 mJ is based on the test conditions that is starting $T_J = 25^\circ\text{C}$, L = 3 mHz, ISCIS = 14.2 A, $V_{CC} = 100\text{ V}$ during inductor charging and $V_{CC} = 0\text{ V}$ during time in clamp.
2. Self Clamped inductive Switching Energy ($E_{SCIS150}$) of 170 mJ is based on the test conditions that is starting $T_J = 150^\circ\text{C}$, L = 3 mHz, ISCIS = 10.6 A, $V_{CC} = 100\text{ V}$ during inductor charging and $V_{CC} = 0\text{ V}$ during time in clamp.



ON Semiconductor[®]

www.onsemi.com

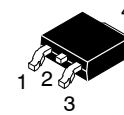
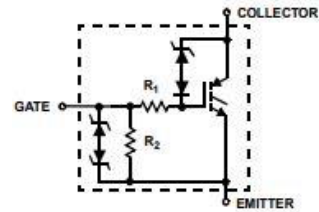

DPAK (SINGLE GAUGE)
CASE 369C

MARKING DIAGRAM

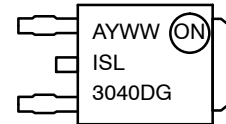

ISL3040DG = Device Code
A = Assembly Location
Y = Year
WW = Work Week
G = Pb-Free Package

ORDERING INFORMATION

See detailed ordering and shipping information on page 2 of this data sheet.

ISL9V3040D3STV

THERMAL RESISTANCE RATINGS

Characteristic	Symbol	Max	Units
Junction-to-Case – Steady State (Drain) (Notes 1, 3 and 4)	$R_{\theta JC}$	1	°C/W

ELECTRICAL CHARACTERISTICS ($T_J = 25^\circ\text{C}$ Unless Otherwise Specified)

Parameter	Symbol	Test Condition	Min	Typ	Max	Unit
-----------	--------	----------------	-----	-----	-----	------

OFF CHARACTERISTICS

Collector to Emitter Breakdown Voltage	BV_{CEr}	$I_{CE} = 2\text{ mA}$, $V_{GE} = 0\text{ V}$, $R_{GE} = 1\text{ K}\Omega$, $T_J = -40\text{ to }150^\circ\text{C}$	370	400	430	V	
Collector to Emitter Breakdown Voltage	BV_{CES}	$I_{CE} = 10\text{ mA}$, $V_{GE} = 0\text{ V}$, $R_{GE} = 0$, $T_J = -40\text{ to }150^\circ\text{C}$	390	420	450	V	
Emitter to Collector Breakdown Voltage	BV_{ECS}	$I_{CE} = -75\text{ mA}$, $V_{GE} = 0\text{ V}$, $T_J = 25^\circ\text{C}$	30	-	-	V	
Gate to Emitter Breakdown Voltage	BV_{GES}	$I_{GES} = \pm 2\text{ mA}$	± 12	± 14	-	V	
Collector to Emitter Leakage Current	I_{CER}	$V_{CE} = 175\text{ V}$, $R_{GE} = 1\text{ K}\Omega$	$T_J = 25^\circ\text{C}$	-	-	25	μA
			$T_J = 150^\circ\text{C}$	-	-	1	mA
Emitter to Collector Leakage Current	I_{ECS}	$V_{EC} = 24\text{ V}$	$T_J = 25^\circ\text{C}$	-	-	1	mA
			$T_J = 150^\circ\text{C}$	-	-	40	
Series Gate Resistance	R_1		-	70	-	Ω	
Gate to Emitter Resistance	R_2		10 K	-	26 K	Ω	

ON CHARACTERISTICS

Collector to Emitter Saturation Voltage	$V_{CE(SAT)}$	$I_{CE} = 6\text{ A}$, $V_{GE} = 4\text{ V}$ $T_J = 25^\circ\text{C}$	-	1.25	1.65	V
Collector to Emitter Saturation Voltage	$V_{CE(SAT)}$	$I_{CE} = 10\text{ A}$, $V_{GE} = 4.5\text{ V}$ $T_J = 150^\circ\text{C}$	-	1.58	1.80	V
Collector to Emitter Saturation Voltage	$V_{CE(SAT)}$	$I_{CE} = 15\text{ A}$, $V_{GE} = 4.5\text{ V}$ $T_J = 150^\circ\text{C}$	-	1.90	2.20	V

DYNAMIC CHARACTERISTICS

Gate Charge	$Q_{G(ON)}$	$I_{CE} = 10\text{ A}$, $V_{CE} = 12\text{ V}$, $V_{GE} = 5\text{ V}$	-	17	-	nC	
Gate to Emitter Threshold Voltage	$V_{GE(TH)}$	$I_{CE} = 1\text{ mA}$, $V_{CE} = V_{GE}$	$T_J = 25^\circ\text{C}$	1.3	-	2.2	V
			$T_J = 150^\circ\text{C}$	0.75	-	1.8	
Gate to Emitter Plateau Voltage	V_{GEP}	$V_{CE} = 12\text{ V}$, $I_{CE} = 10\text{ A}$	-	3.0	-	V	

SWITCHING CHARACTERISTICS

Current Turn-On Delay Time-Resistive	$td_{(ON)R}$	$V_{CE} = 14\text{ V}$, $R_L = 1\text{ }\Omega$ $V_{GE} = 5\text{ V}$, $R_G = 470\text{ }\Omega$ $T_J = 25^\circ\text{C}$	-	0.7	4	μs
Current Rise Time-Resistive	t_{rR}		-	2.1	7	
Current Turn-Off Delay Time-Inductive	$td_{(OFF)L}$	$V_{CE} = 300\text{ V}$, $L = 1\text{ mH}$, $V_{GE} = 5\text{ V}$, $R_G = 470\text{ }\Omega$ $I_{CE} = 6.5\text{ A}$, $T_J = 25^\circ\text{C}$	-	4.8	15	
Current Fall Time-Inductive	tfL		-	2.8	15	

PACKAGE MARKING AND ORDERING INFORMATION

Device Marking	Device	Package	Reel Diameter	Tape Width	Qty
ISL9V3040G1	ISL9V3040D3STV	DPAK (Pb-Free)	330 mm	16 mm	2500

†For information on tape and reel specifications, including part orientation and tape sizes, please refer to our Tape and Reel Packaging Specifications Brochure, BRD8011/D.

ISL9V3040D3STV

TYPICAL CHARACTERISTICS

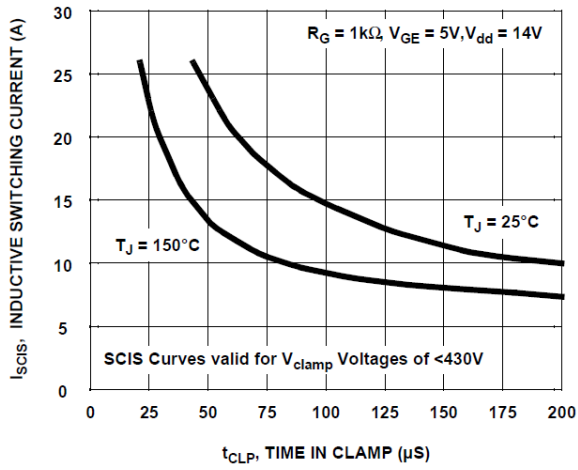

Figure 1. Self Clamped Inductive Switching Current vs. Time in Clamp

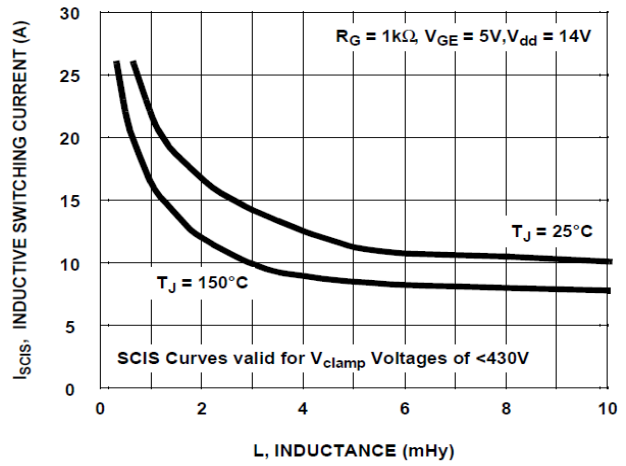

Figure 2. Self Clamped Inductive Switching Current vs. Inductance

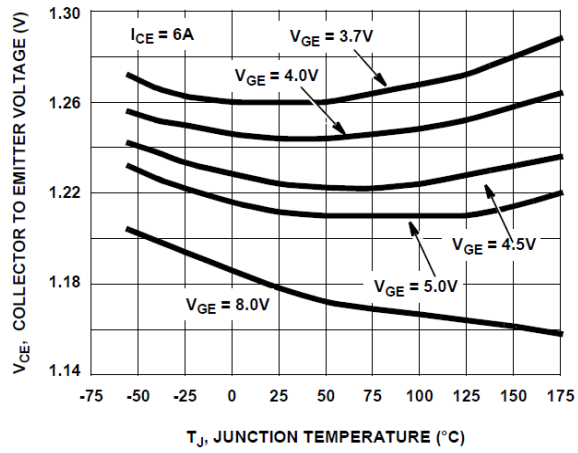

Figure 3. Collector to Emitter On-State Voltage vs. Junction Temperature

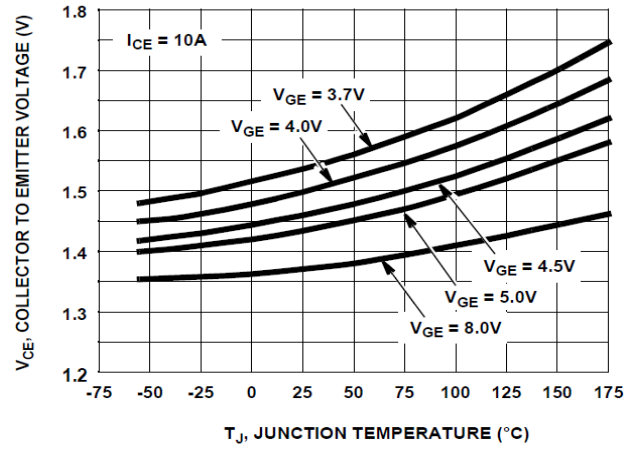

Figure 4. Collector to Emitter On-State Voltage vs. Junction Temperature

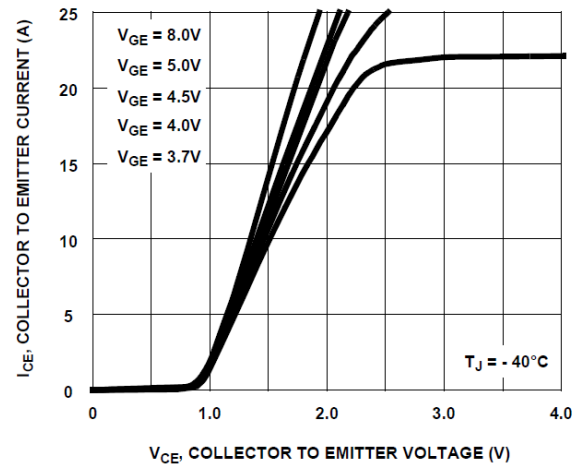

Figure 5. Collector to Emitter On-State Voltage vs. Collector Current

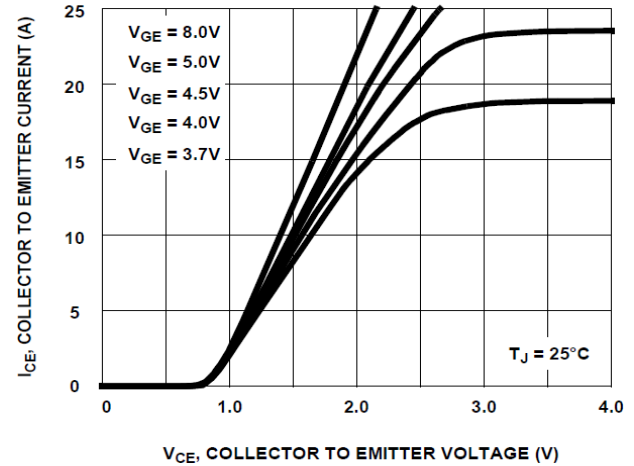

Figure 6. Collector to Emitter On- State Voltage vs. Collector Current

ISL9V3040D3STV

TYPICAL CHARACTERISTICS (continued)

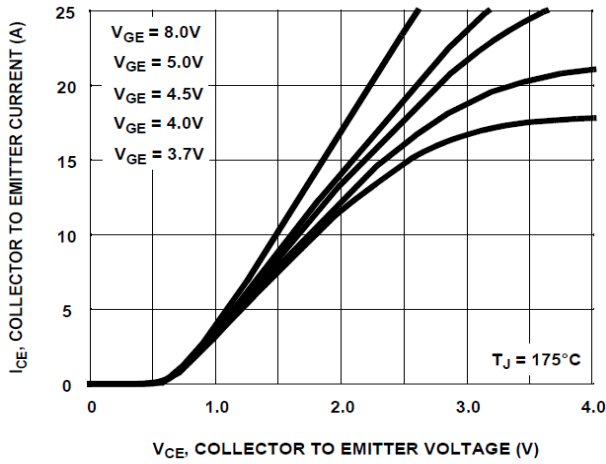

Figure 7. Collector to Emitter On-State Voltage vs. Collector Current

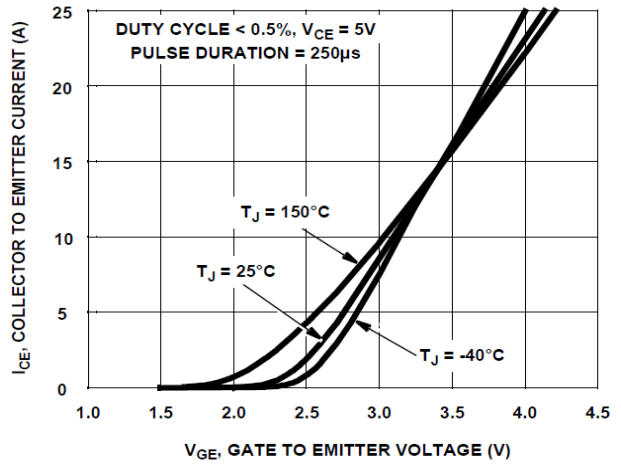

Figure 8. Transfer Characteristics

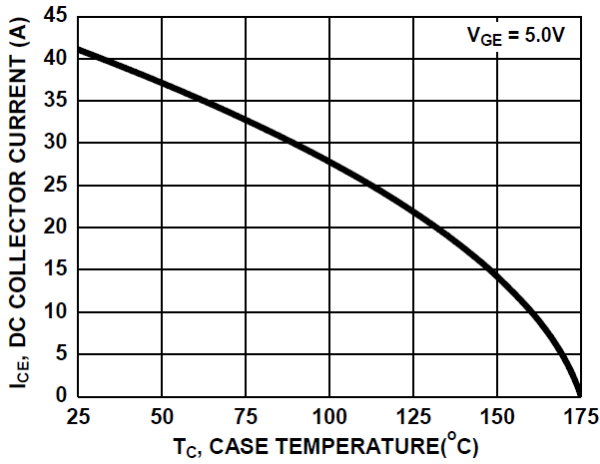

Figure 9. DC Collector Current vs. Case Temperature

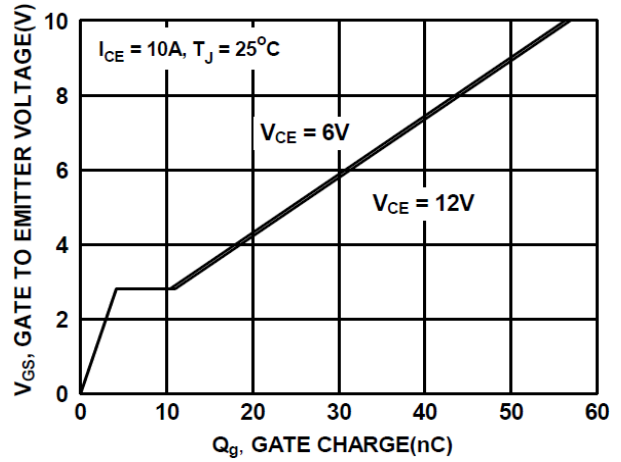

Figure 10. Gate Charge

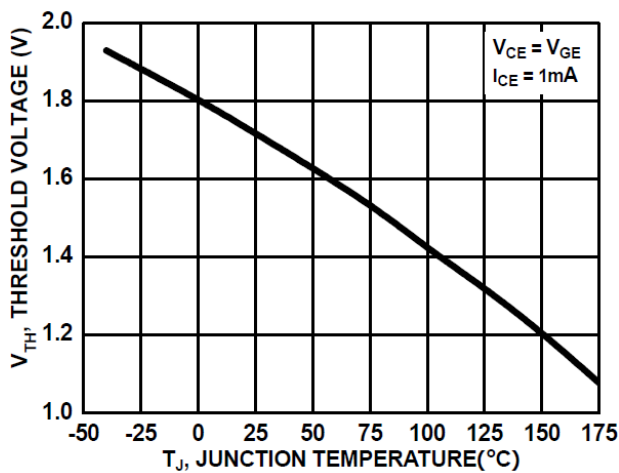

Figure 11. Threshold Voltage vs. Junction Temperature

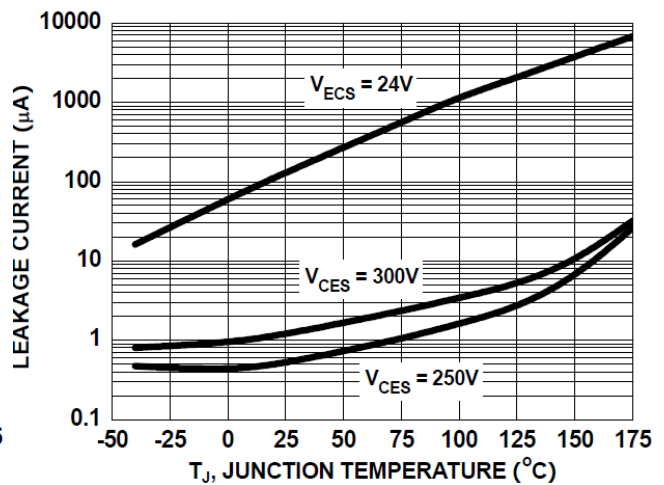

Figure 12. Leakage Current vs. Junction Temperature

ISL9V3040D3STV

TYPICAL CHARACTERISTICS (continued)

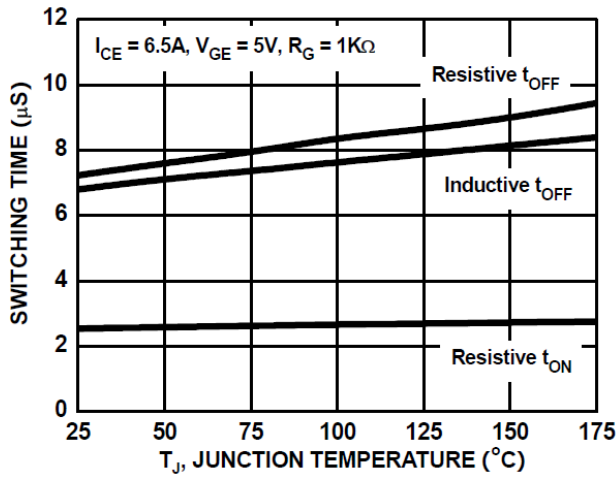

Figure 13. Switching Time vs. Junction Temperature

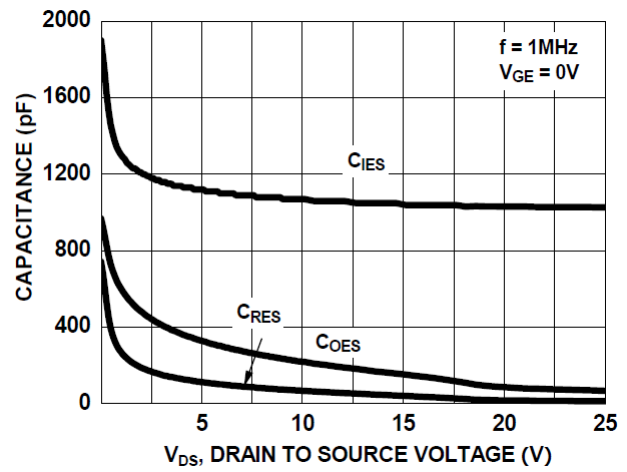

Figure 14. Capacitance vs. Collector to Emitter Voltage

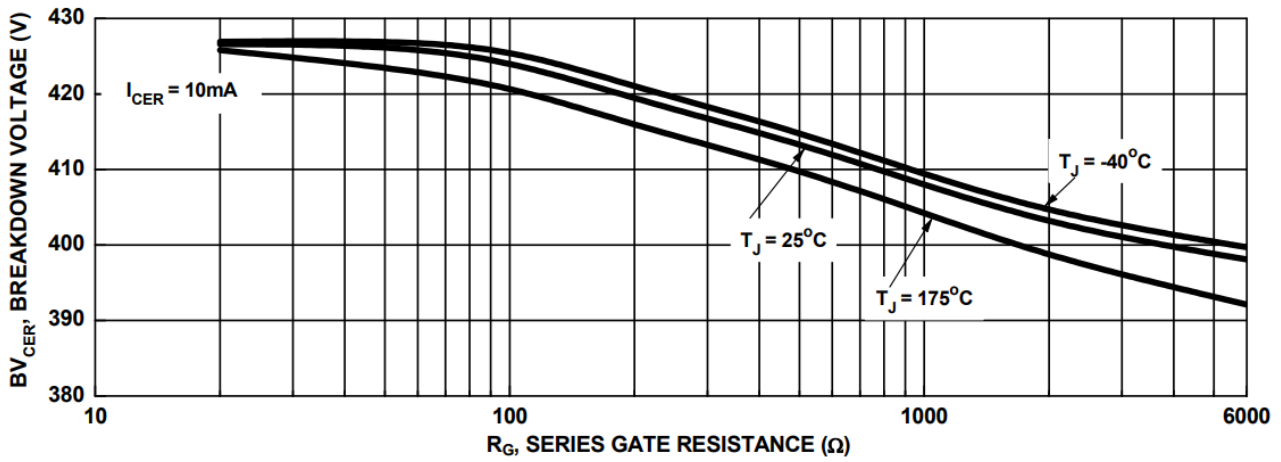

Figure 15. Break down Voltage vs. Series Resistance

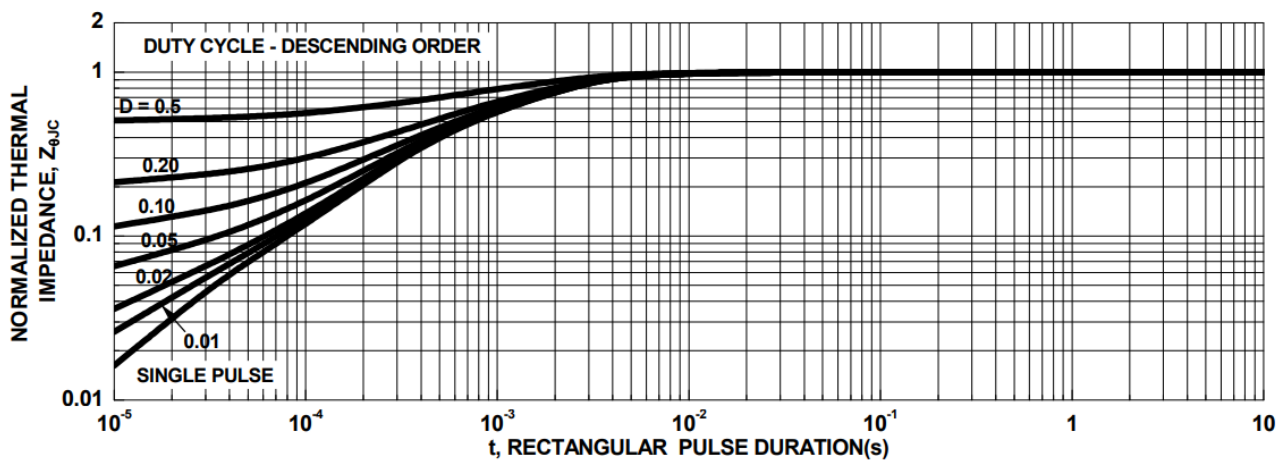

Figure 16. IGBT Normalized Transient Thermal Impedance, Junction to Case

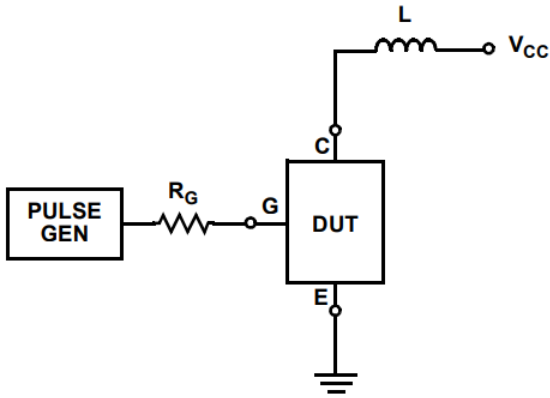

Figure 17. Inductive Switching Test Circuit

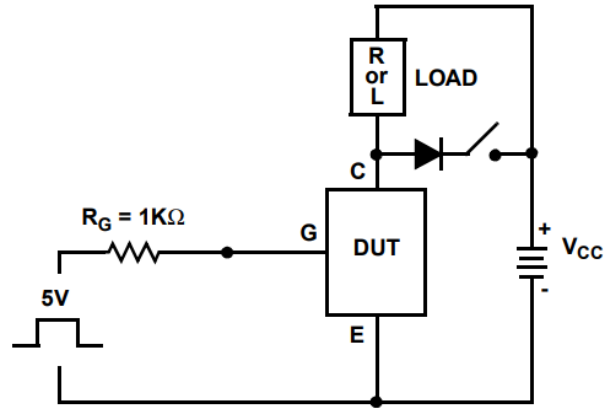

Figure 18. t_{ON} and t_{OFF} Switching Test Circuit

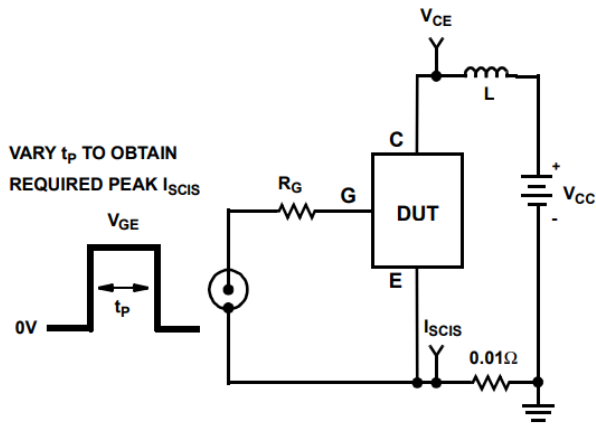

Figure 19. Energy Test Circuit

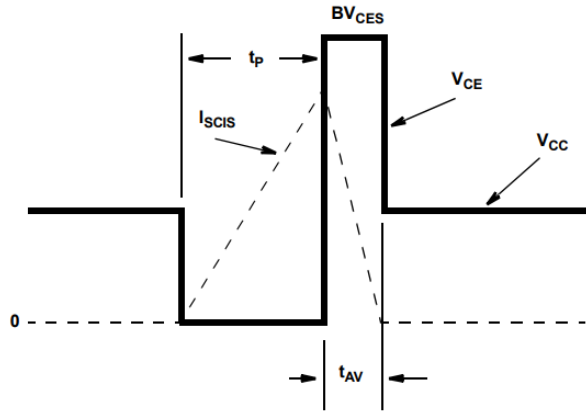
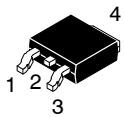

Figure 20. Energy Waveforms

MECHANICAL CASE OUTLINE PACKAGE DIMENSIONS



DPAK (SINGLE GAUGE) CASE 369C ISSUE F

DATE 21 JUL 2015

SCALE 1:1

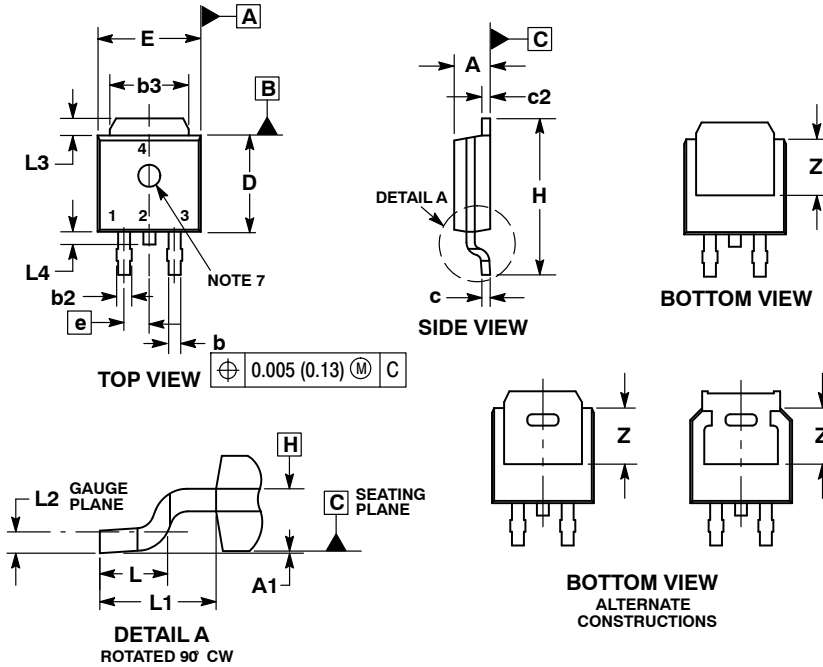

NOTES:

- DIMENSIONING AND TOLERANCING PER ASME Y14.5M, 1994.
- CONTROLLING DIMENSION: INCHES.
- THERMAL PAD CONTOUR OPTIONAL WITHIN DIMENSIONS b3, L3 and Z.
- DIMENSIONS D AND E DO NOT INCLUDE MOLD FLASH, PROTRUSIONS, OR BURRS. MOLD FLASH, PROTRUSIONS, OR GATE BURRS SHALL NOT EXCEED 0.006 INCHES PER SIDE.
- DIMENSIONS D AND E ARE DETERMINED AT THE OUTERMOST EXTREMES OF THE PLASTIC BODY.
- DATUMS A AND B ARE DETERMINED AT DATUM PLANE H.
- OPTIONAL MOLD FEATURE.

DIM	INCHES		MILLIMETERS	
	MIN	MAX	MIN	MAX
A	0.086	0.094	2.18	2.38
A1	0.000	0.005	0.00	0.13
b	0.025	0.035	0.63	0.89
b2	0.028	0.045	0.72	1.14
b3	0.180	0.215	4.57	5.46
c	0.018	0.024	0.46	0.61
c2	0.018	0.024	0.46	0.61
D	0.235	0.245	5.97	6.22
E	0.250	0.265	6.35	6.73
e	0.090	BSC	2.29	BSC
H	0.370	0.410	9.40	10.41
L	0.055	0.070	1.40	1.78
L1	0.114	REF	2.90	REF
L2	0.020	BSC	0.51	BSC
L3	0.035	0.050	0.89	1.27
L4	---	0.040	---	1.01
Z	0.155	---	3.93	---

GENERIC MARKING DIAGRAM*

- | | | | | |
|---|---|--|--|---|
| <p>STYLE 1:
PIN 1. BASE
2. COLLECTOR
3. EMITTER
4. COLLECTOR</p> | <p>STYLE 2:
PIN 1. GATE
2. DRAIN
3. SOURCE
4. DRAIN</p> | <p>STYLE 3:
PIN 1. ANODE
2. CATHODE
3. ANODE
4. CATHODE</p> | <p>STYLE 4:
PIN 1. CATHODE
2. ANODE
3. GATE
4. ANODE</p> | <p>STYLE 5:
PIN 1. GATE
2. ANODE
3. CATHODE
4. ANODE</p> |
| <p>STYLE 6:
PIN 1. MT1
2. MT2
3. GATE
4. MT2</p> | <p>STYLE 7:
PIN 1. GATE
2. COLLECTOR
3. EMITTER
4. COLLECTOR</p> | <p>STYLE 8:
PIN 1. N/C
2. CATHODE
3. ANODE
4. CATHODE</p> | <p>STYLE 9:
PIN 1. ANODE
2. CATHODE
3. RESISTOR ADJUST
4. CATHODE</p> | <p>STYLE 10:
PIN 1. CATHODE
2. ANODE
3. CATHODE
4. ANODE</p> |

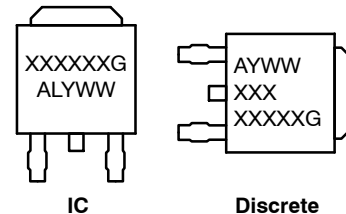

- XXXXXX = Device Code
 A = Assembly Location
 L = Wafer Lot
 Y = Year
 WW = Work Week
 G = Pb-Free Package

*This information is generic. Please refer to device data sheet for actual part marking. Pb-Free indicator, "G" or microdot "•", may or may not be present. Some products may not follow the Generic Marking.

SOLDERING FOOTPRINT*

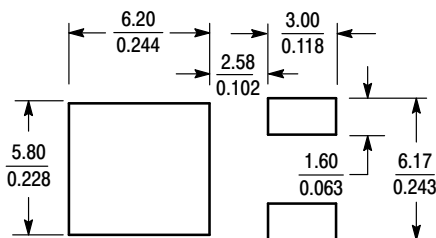

SCALE 3:1 (mm/inches)

*For additional information on our Pb-Free strategy and soldering details, please download the ON Semiconductor Soldering and Mounting Techniques Reference Manual, SOLDERRM/D.

DOCUMENT NUMBER:	98AON10527D	Electronic versions are uncontrolled except when accessed directly from the Document Repository. Printed versions are uncontrolled except when stamped "CONTROLLED COPY" in red.
DESCRIPTION:	DPAK (SINGLE GAUGE)	PAGE 1 OF 1

onsemi and ONSEMI are trademarks of Semiconductor Components Industries, LLC dba onsemi or its subsidiaries in the United States and/or other countries. onsemi reserves the right to make changes without further notice to any products herein. onsemi makes no warranty, representation or guarantee regarding the suitability of its products for any particular purpose, nor does onsemi assume any liability arising out of the application or use of any product or circuit, and specifically disclaims any and all liability, including without limitation special, consequential or incidental damages. onsemi does not convey any license under its patent rights nor the rights of others.

onsemi, **Onsemi**, and other names, marks, and brands are registered and/or common law trademarks of Semiconductor Components Industries, LLC dba "**onsemi**" or its affiliates and/or subsidiaries in the United States and/or other countries. **onsemi** owns the rights to a number of patents, trademarks, copyrights, trade secrets, and other intellectual property. A listing of **onsemi**'s product/patent coverage may be accessed at www.onsemi.com/site/pdf/Patent-Marking.pdf. **onsemi** reserves the right to make changes at any time to any products or information herein, without notice. The information herein is provided "as-is" and **onsemi** makes no warranty, representation or guarantee regarding the accuracy of the information, product features, availability, functionality, or suitability of its products for any particular purpose, nor does **onsemi** assume any liability arising out of the application or use of any product or circuit, and specifically disclaims any and all liability, including without limitation special, consequential or incidental damages. Buyer is responsible for its products and applications using **onsemi** products, including compliance with all laws, regulations and safety requirements or standards, regardless of any support or applications information provided by **onsemi**. "Typical" parameters which may be provided in **onsemi** data sheets and/or specifications can and do vary in different applications and actual performance may vary over time. All operating parameters, including "Typicals" must be validated for each customer application by customer's technical experts. **onsemi** does not convey any license under any of its intellectual property rights nor the rights of others. **onsemi** products are not designed, intended, or authorized for use as a critical component in life support systems or any FDA Class 3 medical devices or medical devices with a same or similar classification in a foreign jurisdiction or any devices intended for implantation in the human body. Should Buyer purchase or use **onsemi** products for any such unintended or unauthorized application, Buyer shall indemnify and hold **onsemi** and its officers, employees, subsidiaries, affiliates, and distributors harmless against all claims, costs, damages, and expenses, and reasonable attorney fees arising out of, directly or indirectly, any claim of personal injury or death associated with such unintended or unauthorized use, even if such claim alleges that **onsemi** was negligent regarding the design or manufacture of the part. **onsemi** is an Equal Opportunity/Affirmative Action Employer. This literature is subject to all applicable copyright laws and is not for resale in any manner.

PUBLICATION ORDERING INFORMATION

LITERATURE FULFILLMENT:

Email Requests to: orderlit@onsemi.com

onsemi Website: www.onsemi.com

TECHNICAL SUPPORT

North American Technical Support:

Voice Mail: 1 800-282-9855 Toll Free USA/Canada

Phone: 011 421 33 790 2910

Europe, Middle East and Africa Technical Support:

Phone: 00421 33 790 2910

For additional information, please contact your local Sales Representative