

REVISIONS

P	LTR	DESCRIPTION	DATE	DWN	APVD
	A1	REVISED PER ECO-11-005150	29MAR2011	RK	HMR
	BA	NEW PRODUCT INTRODUCTION	17JUN2022	LG	AP

FOR FURTHER INFORMATION SEE DATA SHEET FOR CBT SERIES-CARBON COMPOSITION RESISTORS

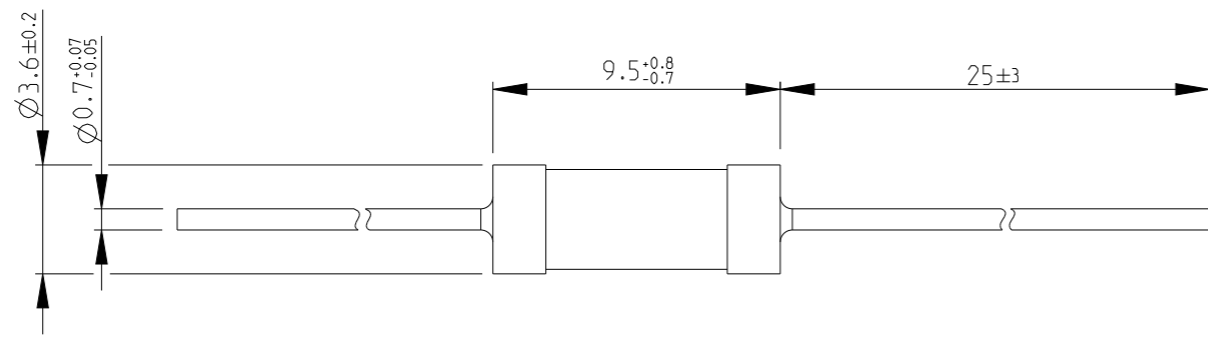

RoHS Compliant

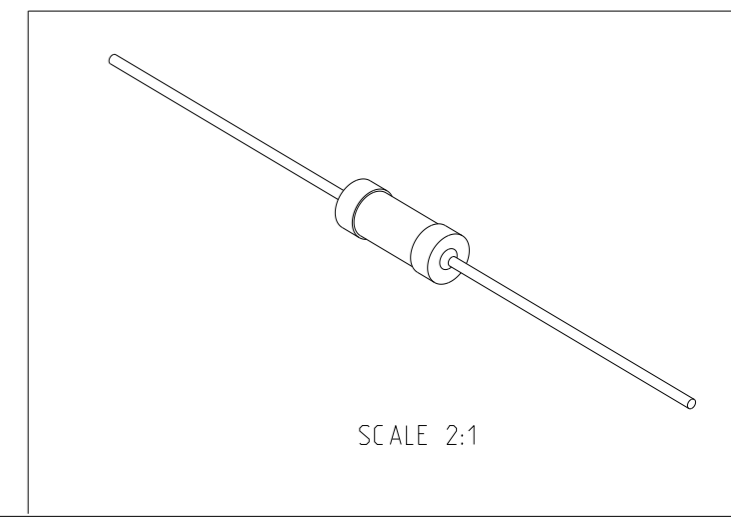

THIS DRAWING IS A CONTROLLED DOCUMENT.		DWN	18SEP2008		
		CHK	18SEP2008		
		APVD	18SEP2008		
		PRODUCT SPEC	STEPHEN.P		
DIMENSIONS: mm		TOLERANCES UNLESS OTHERWISE SPECIFIED:		NAME	
		0 PLC	± 0.2		CARBON COMPOSITION RESISTORS
		1 PLC	± 0.1		TYPE CBT50 SERIES
		2 PLC	\pm		SIZE
		3 PLC	\pm		CAGE CODE
		4 PLC	\pm		DRAWING NO
		ANGLES	$\pm 5^\circ$		RESTRICTED TO
MATERIAL		FINISH		WEIGHT	
				A3 00779 C=1625876	
		CUSTOMER DRAWING		SCALE	4:1
				SHEET	1 OF 5
				REV	BA

REVISIONS

P	LTR	DESCRIPTION	DATE	DWN	APVD
-		SEE SHEET 1	-	-	-

SCHEDULE

TCPN	CATALOGUE NUMBER	PART DESCRIPTION	PART STATUS
1625876-1	CBT50J1M8	CBT 1/2 5% 1M8	DISCONTINUED
1625876-2	CBT50J22R	CBT 1/2 5% 22R	PRODUCTION
1625876-3	CBT50J3K3	CBT 1/2 5% 3K3	DISCONTINUED
1625876-4	CBT50J3R3	CBT 1/2 5% 3R3	PRODUCTION
1625876-5	CBT50J47R	CBT 1/2 5% 47R	PRODUCTION
1625876-6	CBT50K100K	CBT 1/2 10% 100K	PRODUCTION
1625876-7	CBT50K100R	CBT 1/2 10% 100R	PRODUCTION
1625876-8	CBT50K10K	CBT 1/2 10% 10K	DISCONTINUED
1625876-9	CBT50K10R	CBT 1/2 10% 10R	DISCONTINUED
1-1625876-0	CBT50K220R	CBT 1/2 10% 220R	PRODUCTION
1-1625876-1	CBT50K270K	CBT 1/2 10% 270K	DISCONTINUED
1-1625876-2	1-1625876-2	CBT 1/2 10% 270K w	DISCONTINUED
1-1625876-3	CBT50K2R2	CBT 1/2 10% 2R2	DISCONTINUED
1-1625876-4	CBT50K47R	CBT 1/2 10% 47R	DISCONTINUED
1-1625876-5	CBT50K4M7	CBT 1/2 10% 4M7	PRODUCTION
1-1625876-6	CBT50K680R	CBT 1/2 10% 680R	PRODUCTION
1-1625876-7	CBT50J1R0	CBT 1/2 5% 1R0	PRODUCTION
1-1625876-8	CBT50J1K0	CBT 1/2 5% 1K0	PRODUCTION
1-1625876-9	CBT50K2R7	CBT 1/2 10% 2R7	DISCONTINUED
2-1625876-0	CBT50J27R	CBT 1/2 5% 27R	PRODUCTION

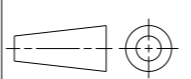
THIS DRAWING IS A CONTROLLED DOCUMENT.		DWN SUBHASH.M 18SEP2008	 TE Connectivity NAME CARBON COMPOSITION RESISTORS TYPE CBT50 SERIES		
DIMENSIONS: mm		CHK PRAKASH.S 18SEP2008			
		APVD STEPHEN.P 18SEP2008			
TOLERANCES UNLESS OTHERWISE SPECIFIED:		PRODUCT SPEC	RESTRICTED TO		
0 PLC ±0.2 1 PLC ±0.1 2 PLC ± 3 PLC ± 4 PLC ± ANGLES ±5°		APPLICATION SPEC	SIZE A3	CAGE CODE 00779	DRAWING NO C-1625876
MATERIAL		WEIGHT	SCALE 4:1		
		CUSTOMER DRAWING	SHEET 2 OF 5		
			REV BA		

REVISIONS

P	LTR	DESCRIPTION	DATE	DWN	APVD
-		SEE SHEET 1	-	-	-

SCHEDULE

TCPN	CATALOGUE NUMBER	PART DESCRIPTION	PART STATUS
2-1625876-1	CBT50J4R7	CBT 1/2 5% 4R7	PRODUCTION
2-1625876-2	CBT50K56K	CBT 1/2 10% 56K	DISCONTINUED
2-1625876-3	CBT50J680R	CBT 1/2 5% 680R	PRODUCTION
2-1625876-4	CBT50K22R	CBT 1/2 10% 22R	DISCONTINUED
2-1625876-5	CBT50K470R	CBT 1/2 10% 470R	DISCONTINUED
2-1625876-6	CBT50J2R2	CBT 1/2 5% 2R2	PRODUCTION
2-1625876-7	CBT50K33R	CBT 1/2 10% 33R	DISCONTINUED
2-1625876-8	CBT50K2K2	CBT 1/2 10% 2K2	DISCONTINUED
2-1625876-9	CBT50J100R	CBT 1/2 5% 100R	PRODUCTION
3-1625876-0	CBT50J200K	CBT 1/2 5% 200K	DISCONTINUED
3-1625876-1	CBT50J100K	CBT 1/2 5% 100K	SUPERSEDED
3-1625876-2	CBT50J10K	CBT 1/2 5% 10K	PRODUCTION
3-1625876-3	CBT50J10M	CBT 1/2 5% 10M	SUPERSEDED
3-1625876-4	CBT50J10R	CBT 1/2 5% 10R	PRODUCTION
3-1625876-5	CBT50J150K	CBT 1/2 5% 150K	SUPERSEDED
3-1625876-6	CBT50J150R	CBT 1/2 5% 150R	PRODUCTION
3-1625876-7	CBT50J15K	CBT 1/2 5% 15K	DISCONTINUED
3-1625876-8	CBT50J15M	CBT 1/2 5% 15M	SUPERSEDED
3-1625876-9	CBT50J15R	CBT 1/2 5% 15R	PRODUCTION
4-1625876-0	CBT50J1K5	CBT 1/2 5% 1K5	PRODUCTION

THIS DRAWING IS A CONTROLLED DOCUMENT.

DIMENSIONS:
mm

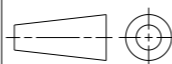

TOLERANCES UNLESS OTHERWISE SPECIFIED:

- 0 PLC ±0.2
- 1 PLC ±0.1
- 2 PLC ±
- 3 PLC ±
- 4 PLC ±
- ANGLES ±5°
- FINISH

MATERIAL

DWN SUBHASH.M 18SEP2008

CHK PRAKASH.S 18SEP2008

APVD STEPHEN.P 18SEP2008

PRODUCT SPEC

APPLICATION SPEC

WEIGHT

CUSTOMER DRAWING



TE Connectivity

NAME
CARBON COMPOSITION RESISTORS
TYPE CBT50 SERIES

SIZE CAGE CODE DRAWING NO RESTRICTED TO

A3 00779 C-1625876

SCALE 4:1 SHEET 3 OF 5 REV BA

REVISIONS

P	LTR	DESCRIPTION	DATE	DWN	APVD
-		SEE SHEET 1	-	-	-

SCHEDULE

TCPN	CATALOGUE NUMBER	PART DESCRIPTION	PART STATUS
4-1625876-1	CBT50J1M0	CBT 1/2 5% 1M0	SUPERSEDED
4-1625876-2	CBT50J1M5	CBT 1/2 5% 1M5	SUPERSEDED
4-1625876-3	CBT50J1R5	CBT 1/2 5% 1R5	PRODUCTION
4-1625876-4	CBT50J220K	CBT 1/2 5% 220K	SUPERSEDED
4-1625876-5	CBT50J220R	CBT 1/2 5% 220R	PRODUCTION
4-1625876-6	CBT50J22K	CBT 1/2 5% 22K	PRODUCTION
4-1625876-7	CBT50J22M	CBT 1/2 5% 22M	SUPERSEDED
4-1625876-8	CBT50J2K2	CBT 1/2 5% 2K2	PRODUCTION
4-1625876-9	CBT50J2M2	CBT 1/2 5% 2M2	SUPERSEDED
5-1625876-0	CBT50J330K	CBT 1/2 5% 330K	SUPERSEDED
5-1625876-1	CBT50J330R	CBT 1/2 5% 330R	PRODUCTION
5-1625876-2	CBT50J33K	CBT 1/2 5% 33K	PRODUCTION
5-1625876-3	CBT50J33R	CBT 1/2 5% 33R	PRODUCTION
5-1625876-4	CBT50J3M3	CBT 1/2 5% 3M3	SUPERSEDED
5-1625876-5	CBT50J470K	CBT 1/2 5% 470K	DISCONTINUED
5-1625876-6	CBT50J470R	CBT 1/2 5% 470R	PRODUCTION
5-1625876-7	CBT50J47K	CBT 1/2 5% 47K	PRODUCTION
5-1625876-8	CBT50J4K7	CBT 1/2 5% 4K7	PRODUCTION
5-1625876-9	CBT50J4M7	CBT 1/2 5% 4M7	SUPERSEDED
6-1625876-0	CBT50J680K	CBT 1/2 5% 680K	DISCONTINUED

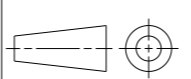
THIS DRAWING IS A CONTROLLED DOCUMENT.		DWN SUBHASH.M 18SEP2008	 TE Connectivity NAME CARBON COMPOSITION RESISTORS TYPE CBT50 SERIES		
DIMENSIONS: mm		CHK PRAKASH.S 18SEP2008			
		APVD STEPHEN.P 18SEP2008			
TOLERANCES UNLESS OTHERWISE SPECIFIED:		PRODUCT SPEC	RESTRICTED TO		
0 PLC ±0.2 1 PLC ±0.1 2 PLC ± 3 PLC ± 4 PLC ± ANGLES ±5°		APPLICATION SPEC	SIZE A3	CAGE CODE 00779	DRAWING NO C-1625876
MATERIAL		FINISH	SCALE 4:1		
		WEIGHT	SHEET 4 OF 5		
		CUSTOMER DRAWING	REV BA		

REVISIONS

P	LTR	DESCRIPTION	DATE	DWN	APVD
	-	SEE SHEET 1	-	-	-

SCHEDULE

TCPN	CATALOGUE NUMBER	PART DESCRIPTION	PART STATUS
6-1625876-1	CBT50J68K	CBT 1/2 5% 68K	PRODUCTION
6-1625876-2	CBT50J68R	CBT 1/2 5% 68R	PRODUCTION
6-1625876-3	CBT50J6K8	CBT 1/2 5% 6K8	PRODUCTION
6-1625876-4	CBT50J6M8	CBT 1/2 5% 6M8	DISCONTINUED
6-1625876-5	CBT50J6R8	CBT 1/2 5% 6R8	PRODUCTION
6-1625876-6	CBT50J2M7	CBT 1/2 5% 2M7	DISCONTINUED
6-1625876-7	CBT50J39R	CBT 1/2 5% 39R	DISCONTINUED
6-1625876-8	CBT50J3R9	CBT 1/2 5% 3R9	DISCONTINUED
6-1625876-9	CBT50J56R	CBT 1/2 5% 56R	PRODUCTION
7-1625876-0	CBT50K2K7	CBT 1/2 10% 2K7	PRODUCTION
7-1625876-1	CBT50J5R1	CBT 1/2 5% 5R1	DISCONTINUED
7-1625876-2	CBT50J820R	CBT 1/2 5% 820R	PRODUCTION
7-1625876-3	CBT50J180K	CBT 1/2 5% 180K	SUPERSEDED
7-1625876-4	CBT50J360R	CBT 1/2 5% 360R	PRODUCTION
7-1625876-5	CBT50K180K	CBT 1/2 10% 180K	PRODUCTION
7-1625876-6	CBT50J220RB	CBT 1/2 5% 220R BULK	PRODUCTION
7-1625876-7	CBT50K150K	CBT 1/2 10% 150K	PRODUCTION
7-1625876-8	CBT50K330K	CBT 1/2 10% 330K	PRODUCTION
7-1625876-9	CBT50K15M	CBT 1/2 10% 15M	PRODUCTION
8-1625876-0	CBT50K2M2	CBT 1/2 10% 2M2	PRODUCTION
8-1625876-1	CBT50K1M0	CBT 1/2 10% 1M0	PRODUCTION
8-1625876-2	CBT50K22M	CBT 1/2 10% 22M	PRODUCTION
8-1625876-3	CBT50K10M	CBT 1/2 10% 10M	PRODUCTION
8-1625876-4	CBT50K1M5	CBT 1/2 10% 1M5	PRODUCTION
8-1625876-5	CBT50K3M3	CBT 1/2 10% 3M3	PRODUCTION
8-1625876-6	CBT50K220K	CBT 1/2 10% 220K	PRODUCTION

THIS DRAWING IS A CONTROLLED DOCUMENT.

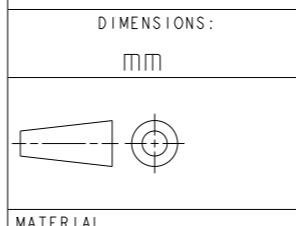

MATERIAL

DIMENSIONS: mm

TOLERANCES UNLESS OTHERWISE SPECIFIED:

0 PLC	±0.2
1 PLC	±0.1
2 PLC	±
3 PLC	±
4 PLC	±
ANGLES	±5°

FINISH

DWN SUBHASH.M 18SEP2008

CHK PRAKASH.S 18SEP2008

APVD STEPHEN.P 18SEP2008

PRODUCT SPEC

APPLICATION SPEC

WEIGHT

CUSTOMER DRAWING

TE TE Connectivity

NAME CARBON COMPOSITION RESISTORS
TYPE CBT50 SERIES

SIZE	CAGE CODE	DRAWING NO	RESTRICTED TO
A3	00779	©-1625876	

SCALE 4:1 SHEET 5 OF 5 REV BA