

SUMMARY



Image is for illustrative purpose only

Wires

Coax 1

Series 3E
Termination type Female solder Coaxial
IP rating 68 when mated
AWG wire size 0.00 - 0.00
Cable Ø 0.00 - 0.00 mm
Status active

Download

[Request a quote](#)
[Catalog](#)

TECHNICAL DETAILS

Mechanics

Shell Style/Model HGP*: Fixed receptacle, nut fixing, watertight or vacuum-tight
Keying Circular, female
Housing Material Brass (chrome plated [SAE AMS 2460]) shell, collet nut and latch sleeve, nickel plated [SAE AMS QQ N 290] brass mid pieces
Variant P : Watertight unmated
Weight 74.39 g

Performance

Configuration 3E.275 : 1 Coax (75 Ohm)
Insulator L: PEEK (UL 94 / V-0/1.5)
Rated Current 15 Amps

Specifications

Contact Type: Solder
Vtest: 2700 V (AC), 3900 V (DC)
Impedance: 75 Ohm
VSWR: 1.04 + 0.05 * f /GHz
Cable type: RG 213/U, RG 115 A/U, RG 11 A/U, RG 144/U, RG 165 /U

LEMO products and services are provided "as is". LEMO makes no warranties or representations with regard to LEMO product & services or use of them, express, implied or statutory, including for accuracy, completeness, or security. The user is fully responsible for his products and applications using LEMO components.

Others

Endurance (Shell): 5000 mating cycles
Temp (min / max): -20°C / +80°C
Humidity (max): <=95% [at 60 deg C /140 F]
Vibration: 15 g [10 Hz - 2000 Hz]
Shock Resistance: 100 g [6 ms]
Climatical Category: 20/80/21
Shielding (min): 95 dB (10 MHz)
Shielding (min): 80 dB (1 GHz)
Salt Spray Corrosion: >1000 hr
Pressure: 30 bars

DRAWINGS

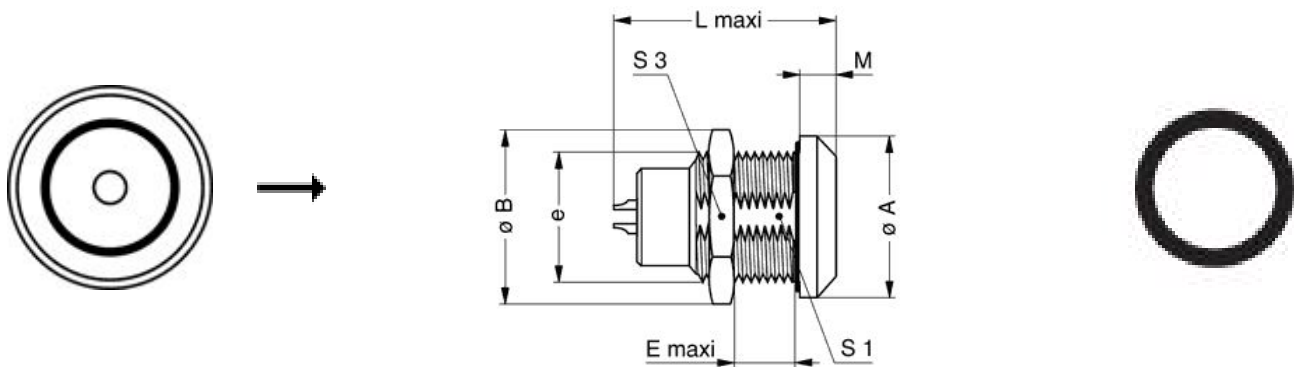

Dimensions

	A	B	E	L	M	S1	S3	e
mm.	31	34	15.5	39.5	6	22.5	30	M24x1.0
in.	1,22	1,34	0,61	1,56	0,24	0,89	1,18	

RECOMMENDED BY LEMO

Tools

LEMO products and services are provided "as is". LEMO makes no warranties or representations with regard to LEMO product & services or use of them, express, implied or statutory, including for accuracy, completeness, or security. The user is fully responsible for his products and applications using LEMO components.

LEMO products and services are provided "as is". LEMO makes no warranties or representations with regard to LEMO product & services or use of them, express, implied or statutory, including for accuracy, completeness, or security. The user is fully responsible for his products and applications using LEMO components.