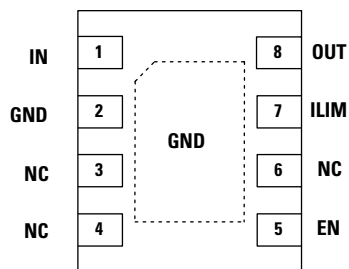

LS0505EVD22

5 V, 5 A eFuse with Over Voltage and Over Current Protection

**Pinout Designation****Pin Description**

Pin #	Pin Name	Description
2	GND	Ground pin
1	IN	Input pin
8	OUT	Output pin. OUT is discharged to GND through an internal 80Ω resistor during OVP event.
7	ILIM	Current limit program pin. Program the current limit by connecting a resistor to ground. This pin can't be short to ground.
5	EN	Enable interface pin. Pull it above ON threshold to enable the IC. Pull it below OFF threshold to disable the IC.
3,4,6	NC	No Connection.

Description

The LS0505EVD22 integrated load switch provides a robust input over-current protection to downstream circuit systems. The device comes with built-in over-voltage protection, internal soft-start. The switch's low RDS(ON) minimizes power loss of the system. In the event of input over voltage, LS0505EVD22 immediately turns off the switch to prevent downstream system from stress of excessive high voltage. Set the current limit level with an external resistor. Internal soft-start ensures a smooth output voltage ramp-up and limits the input in-rush current.

Features & Benefits

- Wide Input Voltage Range from 2.7V to 6V
- 30 V Maximum Input / output Voltage
- 50mΩ Low RDS(ON) Protection Switch
- Built-in Fast Response Over-Voltage Protection at 6.2 V
- Discharge Output at OVP
- Internal Soft-Start
- Thermal Shutdown
- Programmable Current Limit Peak Current up to 5 A
- Hiccup Mode Protection for Over Load or Short Circuit
- DFN2X2_8L Package
- Pb-Free and RoHS compliant

Applications

- Bluetooth Headsets
- Wearable Device
- Tablet PC
- Charging Cable
- Battery Devices
- Adapter Powered Devices

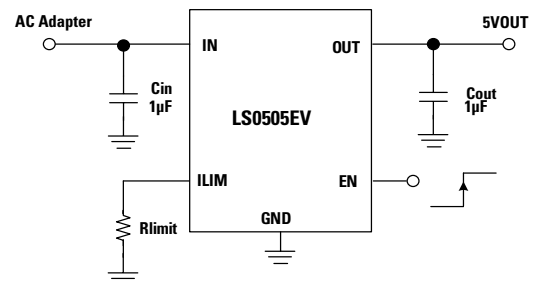
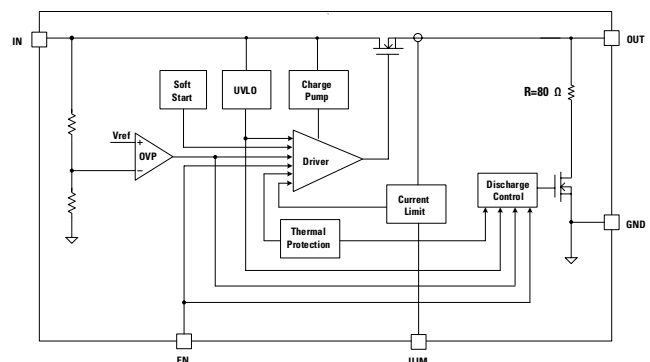
Typical Applications**Functional Block Diagram**

LS0505EVD22

5 V, 5 A eFuse with Over Voltage and Over Current Protection

Absolute Maximum Rating (Reference to GND)

Symbol	Value	Units
IN, OUT, EN	-0.3 to +30	V
ILIM	-0.3 to +6.5	V
ESD, Human Body Model (HBM)	±2000	V
Junction Temperature Range	-40 to +150	°C
Storage Temperature Range	-65 to +150	°C
Lead Temperature (Soldering 10s)	260	°C

Notes:

- Stress exceeding those listed "Absolute Maximum Ratings" may damage the device.
- ESD HBM testing per JEDEC22-A114F

Thermal information

Symbol	Value	Units
Maximum Power Dissipation ($T_A=25^\circ\text{C}$)	1.52	W
Thermal Resistance (θ_{JA})	82	°C/W
Thermal Resistance (θ_{JC})	52	°C/W

Notes:

- Measured on JE5D51-7, 4-Layer PCB.
- The maximum allowable power dissipation is a function of the maximum junction temperature $T_{J,MAX}$, the junction to ambient thermal resistance θ_{JA} , and the ambient temperature T_A . The maximum allowable continuous power dissipation at any ambient temperature is calculated by $P_{D,MAX} = (T_{J,MAX} - T_A) / \theta_{JA}$. Exceeding the maximum allowable power dissipation will cause excessive die temperature, and the regulator will go into thermal shutdown. Internal thermal shutdown circuitry protects the device from permanent damage.

Recommend Operating Conditions

Symbol	Value	Units
Input Voltage (IN)	+2.7 to +28	V
Junction Temperature Range	+125	°C

Notes: The device is not guaranteed to function outside of the recommended operating conditions.

Electrical Characteristics ($T_A = +25^\circ\text{C}$, $V_{IN} = 5\text{ V}$, $C_{IN} = 1\ \mu\text{F}$, unless otherwise specified)

Symbol	Parameter	Test Conditions	Min	Typ	Max	Unit
V_{IN}	Input Voltage Range		2.7		28	V
I_{BIAS}	Quiescent Current			200	260	μA
I_{SD}	Shutdown Current	$V_{EN} = 0\text{V}$		5	10	μA
V_{UV}	Input Under-voltage Threshold			2.48		V
V_{UVHYS}	Input Under-voltage Hysteresis			180		mV
V_{OV}	Input Over-voltage Threshold			6.2		V
V_{OV}	Over Voltage Protection response time			250		nS
V_{OV}	Input Over-voltage Hysteresis			330		mV
T_{SS}	Soft-start Slew Rate Time			230		μs
I_{LIMT}	Current Limit	$R_{LIM} = 500\ \text{k}\Omega$	1.35	1.5	1.65	A
		I_{LIM} pin float		5		
K_{LIM}	Current Limit Setting Factor	$I_{INLIM} = 1\ \text{A} \sim 5\ \text{A}$	675	750	825	$\text{A} \cdot \text{k}\Omega$
R_{Disch}	OUT Discharging Resistance	$V_{IN} = 6.5\ \text{V}$		80		Ω
$V_{IH,EN}$	EN Logic High Input Voltage		1.2			V
$V_{IL,EN}$	EN Logic Low Input Voltage				0.4	V
T_{SD}	Thermal Shutdown Temperature			160		°C
T_{HYS}	Thermal Shutdown Hysteresis			40		°C

LS0505EVD22

5 V, 5 A eFuse with Over Voltage and Over Current Protection

Quiescent Current vs. Input Voltage

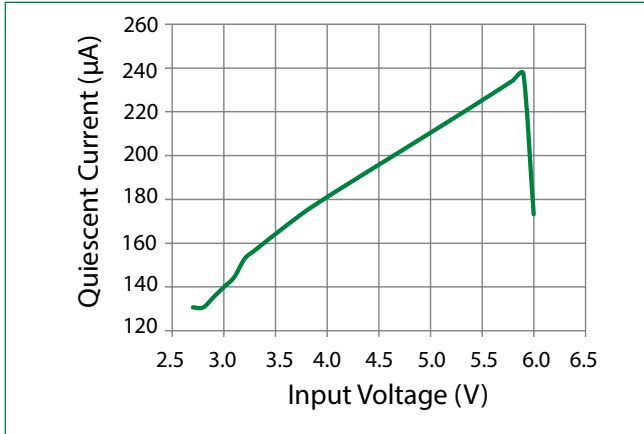

RLimit vs. Ilimit (5V_{IN} Application)

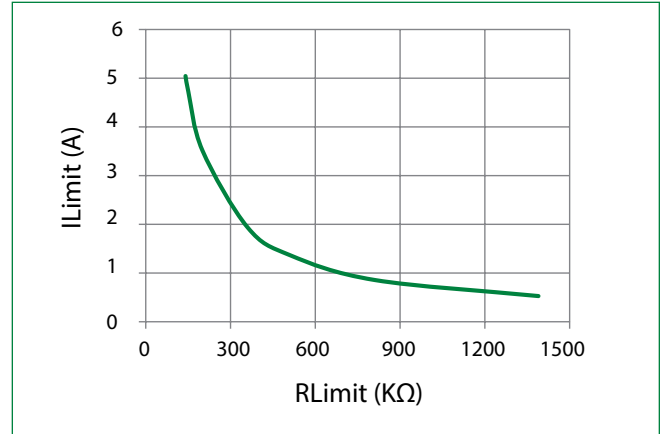

V_{IN} On (5V_{IN}, I_O=0 A)

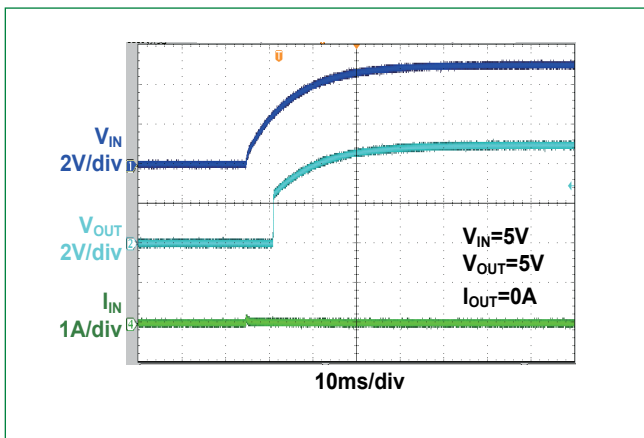

V_{in} Off (5V_{IN}, I_O=0 A)

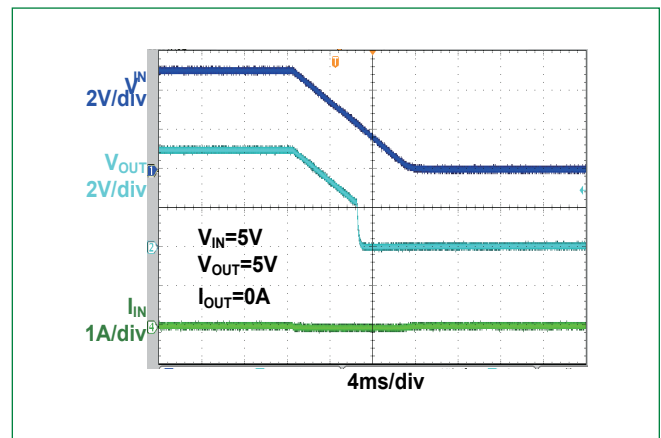

V_{IN} On (5V_{IN}, I_O=3 A)

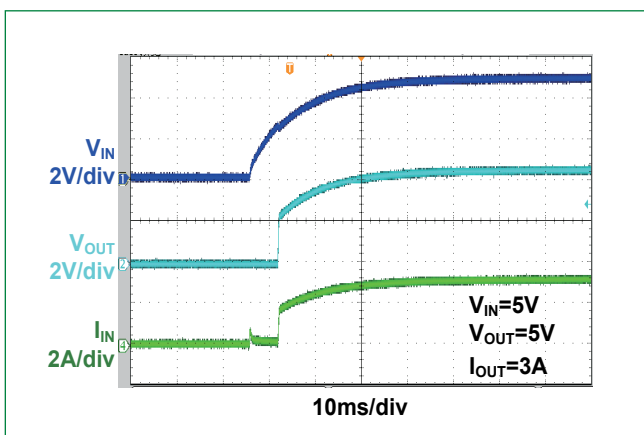

V_{IN} Off (5V_{IN}, I_O=3 A)

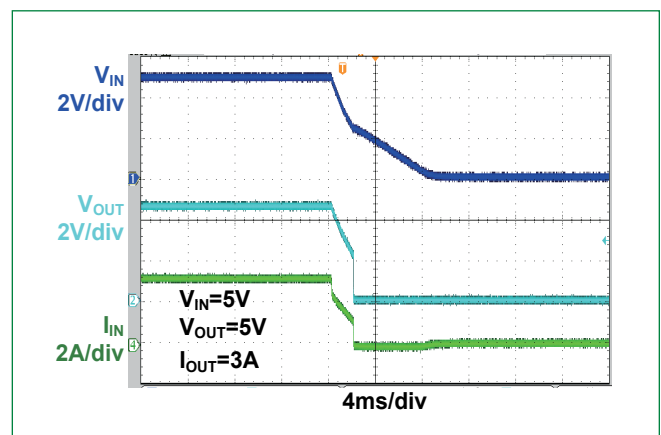

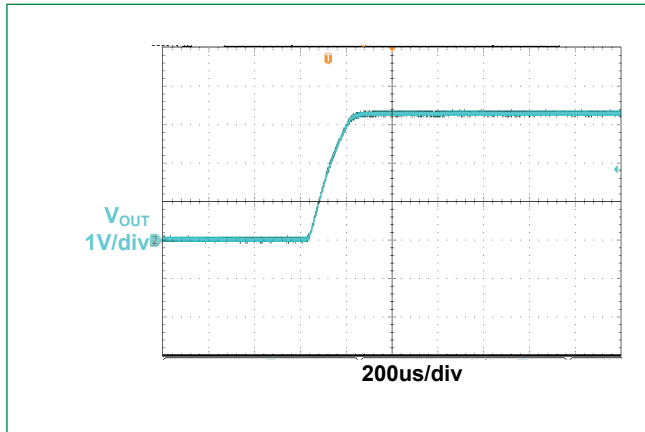
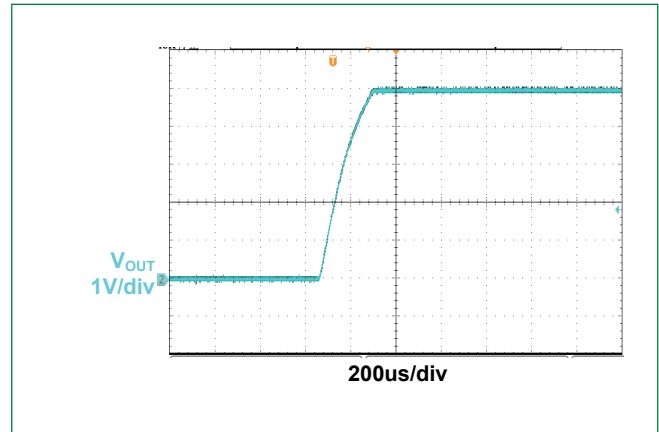
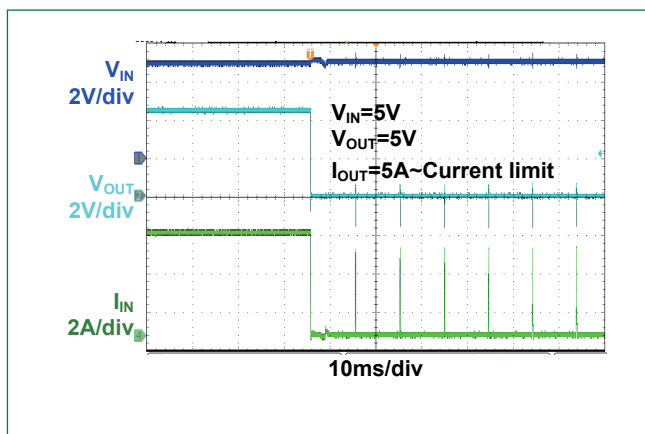
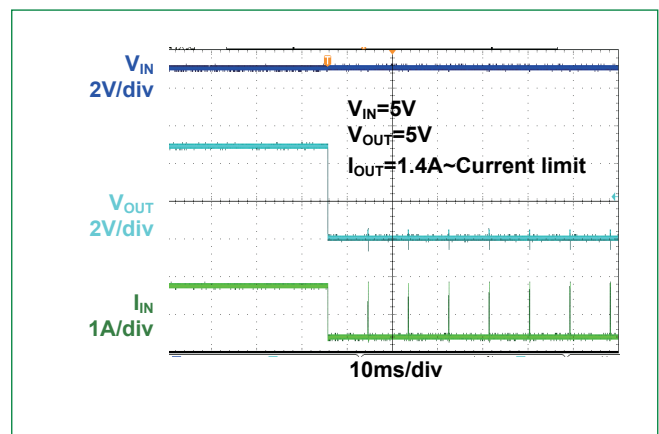
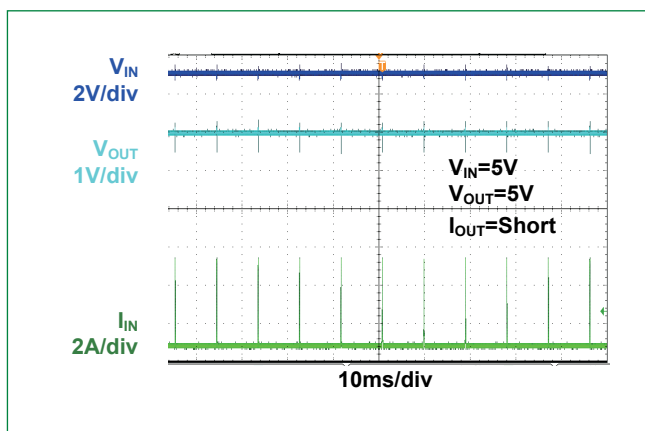
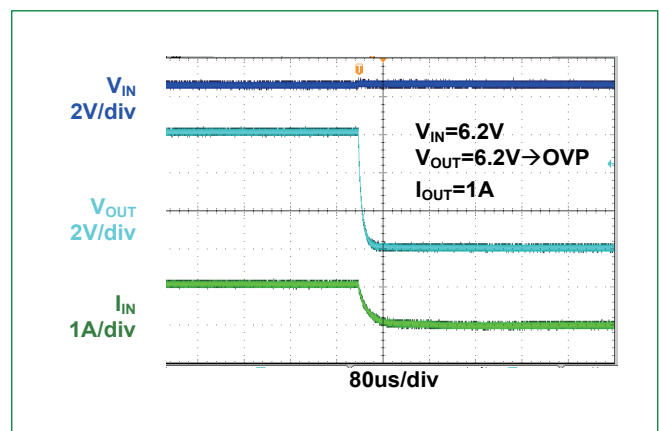
LS0505EVD22**5 V, 5 A eFuse with Over Voltage and Over Current Protection****Soft Start (3.3V_{IN}, I_O=0A)****Soft Start (5V_{IN}, I_O=0A)****Current Limit (5V_{IN}, Rlimit=float)****Current Limit (5V_{IN}, Rlimit=500k)****Short Protection (5V_{IN}, Rlimit=float)****Over Voltage Protection (5V_{IN} Application, I_O=1A)**

LS0505EVD22

5 V, 5 A eFuse with Over Voltage and Over Current Protection

Detailed Description

The LS0505EVD22 is a fully integrated load switch with built-in over-voltage protection, internal soft-start and programmable current limit. When the input voltage is within the valid range (2.7V~28V), the output pin OUT will ramp up with a fixed slew rate defined by internal soft-start. After OUT ramps up to input level, the internal load switch is fully turned on and ready to supply power to the system.

LS0505EVD22 continuously monitors the system load current through the switch when the power is on. Once the load current reaches the current limit ILIMIT programmed by ILIMIT pin, LS0505EVD22 will regulate the load current for 60 μs to prevent the load current from running away. After 60μs, if the current limit condition sustains, LS0505EVD22 will turn off the load switch, wait for 8 ms and then try to re-start. In the event of system short circuit failure, the load current could jump significantly higher than the current limit. Whenever the load current is 2 A larger than the current limit level, LS0505EVD22 immediately turns off the load switch to prevent disastrous outcome, then also for 8ms before it tries to re-start.

LS0505EVD22 has an internal input OVP to protect the system from being stressed by excessively high voltage. Once it detects input voltage is higher than the built-in over-voltage threshold, LS0505EVD22 immediately turns off the load switch. The load switch turns on automatically once the input voltage falls within the valid range.

The LS0505EVD22 also has thermal shutdown protection, when device temperature (T_j) exceeds T_{SHDN} , typically 160°C, the thermal shutdown circuitry will shut down the internal MOSFET thereby disconnecting the load from the input supply. The LS0505EVD22 will remain off during a cooling period until device temperature falls below $T_{SHDN} - 40^\circ\text{C}$, after which it will attempt to restart.

Programmable Over-Current Protection

A programmable current limit level and short circuit current protection has been designed to prevent the load current overload the regulator. When the input current limit loop is engaged, input current will be automatically reduced to the pre-determined level which is set by I_{LIM} pin, and regulate the load current for 60μs, then enter hiccup mode waiting for 8ms to reduce power dissipation. When a short event happens, the short protection circuit will be triggered and turn off power switch quickly, LS0505EVD22 will restart after 8ms. The output can be shorted to ground indefinitely without damaging the part.

Input current limit can be programmed with below equation:

$$I_{INLIM} = \frac{750A * k\Omega}{R_{ILIM}}$$

Where R_{LIM} is the program resistor at the I_{LIM} pin.

Program Current Limit Resistance (kΩ)	750	375	250	187.5	150
Current Limit I_{INLIM} (A)	1	2	3	4	5

For the stable system operation, recommend to set the current limit level 1.2~1.5 times of the maximum system load current to avoid mis-triggering the current limit and causing system malfunctions.

Soft Start

When LS0505EVD22 is power on, VOUT will ramp up with a controlled rising time for minimizing inrush current.

Enable

Enable interface pin. Pull it above ON threshold High to enable the IC. Pull it below OFF threshold to disable the IC.

Input and Output Capacitor Selection

The LS0505EVD22 require $\geq 1 \mu\text{F}$ input and output capacitor connected to GND. Although X7R type capacitors are recommended, X5R and others may be used.

PCB Layout Guideline

- For all applications, a 0.1μF or greater ceramic decoupling capacitor is recommended between IN terminal and GND, and a 0.1μF or greater ceramic decoupling capacitor is recommended between OUT terminal and GDN. For hot-plug applications, where input power path inductance is negligible, this capacitor can be eliminated/minimized.
- The optimum placement of decoupling capacitor is closest to the IN and GND terminals of the device. Care must be taken to minimize the loop area formed by the bypass-capacitor connection, the IN terminal, and the GND terminal of the IC.
- High current carrying power path connections should be as short as possible and should be sized to carry at least twice the full-load current.
- The GND terminal must be tied to the PCB ground plane at the terminal of the IC. The PCB ground should be a copper plane or island on the board.
- Obtaining acceptable performance with alternate layout schemes is possible; however, this layout has been shown to produce good results and is intended as a guideline.

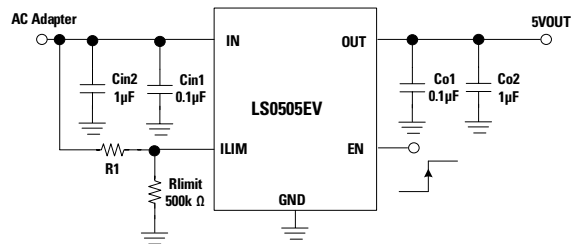
LS0505EVD22**5 V, 5 A eFuse with Over Voltage and Over Current Protection****Application Schematic****Bill of Materials**

Qty	Ref	Value	Description	Package
2	CIN2, CO2	1μF	Ceramic Capacitor, 35 V, X5R	0805
2	CIN1, CO1	0.1μF	Ceramic Capacitor, 35 V, X5R	0603
1	Rlimit	500kΩ	Resistor, ±1%	0603
1	R1	NC	Resistor, ±1%	0603
1	U1	LS0505EV	eFuse IC	DFN2x2_8L

Soldering Parameters

Average ramp up rate (T_{smin} to T_p)	1~2°C/second, 3°C/second max.	
Preheat & Soak	- Temperature Min (T _{s(min)})	150°C
	- Temperature Max (T _{s(max)})	200°C
	- Time (min to max) (t _s)	60 – 120 secs
Time maintained above	- Temperature (T _L)	217°C
	- Time (t _L)	60~150 seconds
Peak Temperature (T_p)	See Classification Temp intable1	
Time within 5°C of actual peak Temperature (t_p)	30 seconds max	
Ramp-down Rate	6°C/second max	
Time 25 °C to peak Temperature (T_p)	8 minutes Max.	

Notes:

1. Tolerance for peak profile Temperature(T_p) is defined as a supplier minimum and a user maximum.
2. Tolerance for time at peak profile temperature (t_p) is defined as a supplier minimum and a user maximum.

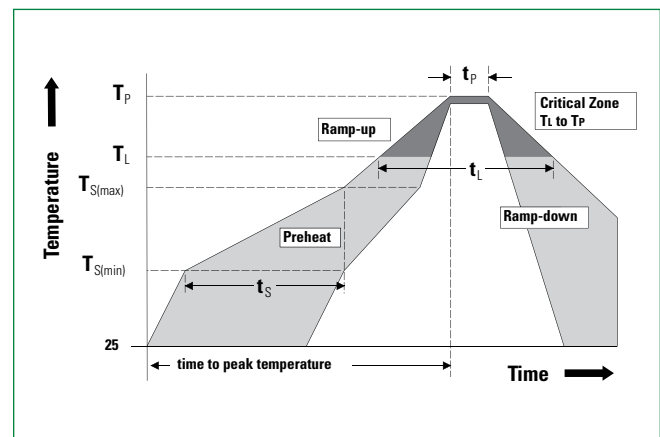
**Ordering Information**

Part Number	Package	Min. Order Qty.
LS0505EVD22	DFN2x2_8L	3000/Tape & Reel

Pb-free Process – Classification Temperatures (T_c)

Package Thickness	Volume mm ³ <350	Volume mm ³ 350-2000	Volume mm ³ >2000
<1.6 mm	260 °C	260 °C	260 °C
1.6 mm–2.5 mm	260 °C	250 °C	245 °C
>2.5 mm	250 °C	245 °C	245 °C
-	3,4,5,6	NC	No Connection

Note: For all temperature information, please refer to topside of the package, measured on the package body surface.

LS0505EVD22

5 V, 5 A eFuse with Over Voltage and Over Current Protection

Part Numbering

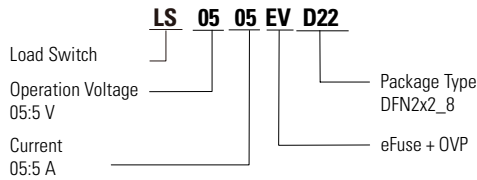

Part Marking

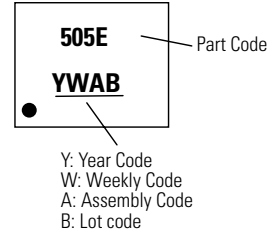

Dimensions – DFN2x2_8L

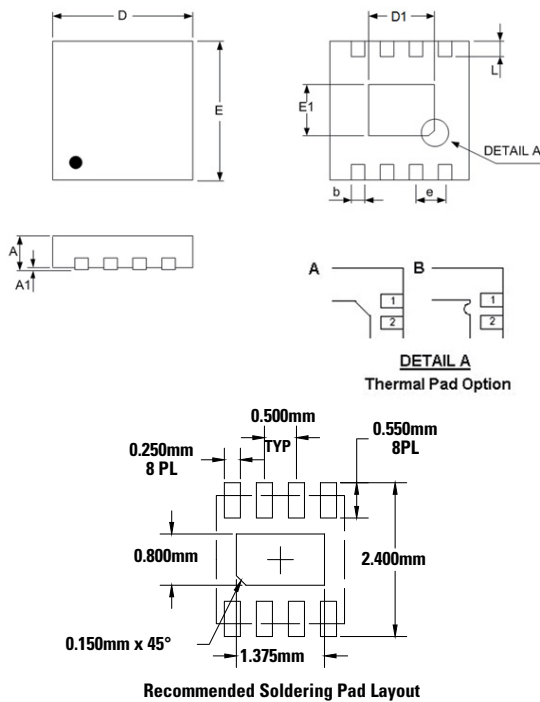

Dimension	Millimeters		Inches	
	MIN	MAX	MIN	MAX
A	0.70	0.80	0.028	0.031
A1	0.00	0.05	0.000	0.002
b	0.18	0.30	0.007	0.012
D	1.90	2.10	0.075	0.083
D1	1.10	1.65	0.043	0.065
E	1.90	2.10	0.075	0.083
E1	0.50	1.10	0.020	0.043
e	0.50		0.020	
L	0.25	0.45	0.010	0.018

Carrier Tape & Reel Specification – DFN2x2_8L

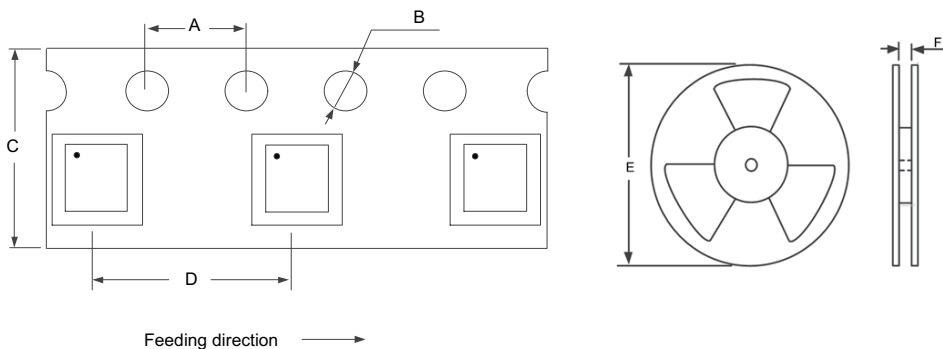

Symbol	Millimeters
A	4.0
B	1.5
C	8.0
D	4.0
E	7 inch
F	9.0

Product Disclaimer - Littelfuse products are not designed for, and shall not be used for, any purpose (including, without limitation, automotive, military, aerospace, medical, life-saving, life-sustaining or nuclear facility applications, devices intended for surgical implant into the body, or any other application in which the failure or lack of desired operation of the product may result in personal injury, death, or property damage) other than those expressly set forth in applicable Littelfuse product documentation. Warranties granted by Littelfuse shall be deemed void for products used for any purpose not expressly set forth in applicable Littelfuse documentation. Littelfuse shall not be liable for any claims or damages arising out of products used in applications not expressly intended by Littelfuse as set forth in applicable Littelfuse documentation. The sale and use of Littelfuse products is subject to Littelfuse Terms and Conditions of Sale, unless otherwise agreed by Littelfuse. "Littelfuse" includes Littelfuse, Inc., and all of its affiliate entities.

<https://www.littelfuse.com/legal/disclaimers/product-disclaimer.asp>