

# Rail-to-Rail Quad Unity-Gain Operational Amplifier

## General Description

The RT9136 consists of low cost, high slew rates, single-supply rail-to-rail input and output operation amplifiers. The RT9136 contains four amplifiers in one package.

Operating on supplies ranging from 4.5V to 16.5V, while consuming only 500µA per channel, the RT9136 has high slew rates (12V/µs), 35mA continuous output current, 120mA peak output current and offset voltage below 10mV. The RT9136 is ideal for Thin Film Transistor Liquid Crystal Displays (TFT-LCD), GAMMA Buffer or repair circuit.

The RT9136 is available in MSOP-10 package and is specified for operation over the full -40°C to 85°C temperature range.

## Ordering Information

- RT9136 □ □
- Package Type  
F : MSOP-10
  - Lead Plating System  
P : Pb Free  
G : Green (Halogen Free and Pb Free)  
Z : ECO (Ecological Element with Halogen Free and Pb free)

Note :

Richtek products are :

- ▶ RoHS compliant and compatible with the current requirements of IPC/JEDEC J-STD-020.
- ▶ Suitable for use in SnPb or Pb-free soldering processes.

## Features

- Rail-to-Rail Output Swing
- Unity gain buffer
- Supply Voltage : 4.5V to 16.5V
- Continuous Output Current : 35mA
- Peak Output Current : 120mA
- High Slew Rate : 12V/µs
- RoHS Compliant and 100% Lead (Pb)-Free

## Applications

- TFT-LCD Gamma / V<sub>COM</sub> Buffer
- Portable Electronic Product
- Communications Product

## Pin Configurations

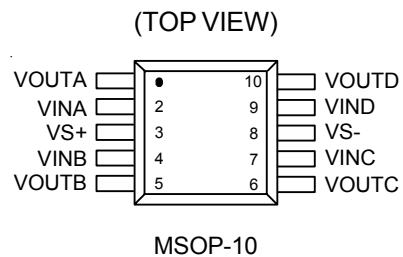

## Marking Information

RT9136PF

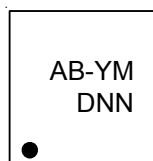

AB- : Product Code  
YMDNN : Date Code

RT9136GF

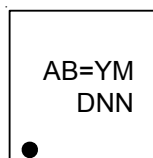

AB= : Product Code  
YMDNN : Date Code

RT9136ZF

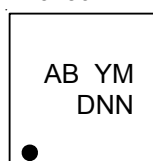

AB : Product Code  
YMDNN : Date Code

## Function Block Diagram

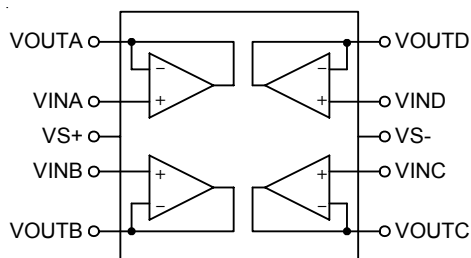

## Functional Pin Description

Pin No.	Pin Name	Pin Function
1	VOUTA	Amplifier A Output.
2	VINA	Amplifier A Input.
3	VS+	Positive Power Supply.
4	VINB	Amplifier B Input.
5	VOUTB	Amplifier B Output.
6	VOUTC	Amplifier C Output.
7	VINC	Amplifier C Input.
8	VS-	Negative Power Supply.
9	VIND	Amplifier D Input.
10	VOUTD	Amplifier D Output.

**Absolute Maximum Ratings** (Note 1)

- Supply Voltage between VS+ and VS- ----- 18V
- Input Voltage ----- -0.5V to Vs+0.5V
- Differential Input Voltage ----- Vs
- Power Dissipation, PD @ TA = 25°C
- MSOP-10 ----- 833mW
- Package Thermal Resistance (Note 2)
- MSOP-10,  $\theta_{JA}$  ----- 120°C/W
- Lead Temperature (Soldering, 10 sec.) ----- 260°C
- Junction Temperature ----- 150°C
- Storage Temperature Range ----- -65°C to +150°C
- ESD Susceptibility (Note 3)
- HBM (Human Body Mode) ----- 2kV
- MM (Machine Mode) ----- 200V

**Recommended Operating Conditions** (Note 4)

- Junction Temperature Range ----- -40°C to 125°C
- Ambient Temperature Range ----- -40°C to 85°C

**Electrical Characteristics**

(VS+ = 5V, VS- = -5V, RL = 10kΩ and CL = 10pF, TA = 25°C, unless otherwise specified)

Parameter	Symbol	Test Conditions	Min	Typ	Max	Unit
<b>Input Characteristics</b>						
Input Offset Voltage	VOS	VCM = 0	--	2	15	mV
Average Offset Voltage Drift	$\Delta V_{OS}/\Delta T$	-40°C ≤ TA ≤ 85°C	--	5	--	μV/°C
Input Bias Current	IB	VCM = 0	--	2	50	nA
Input Impedance	RIN		--	1	--	GΩ
Input Capacitance	CIN		--	1.35	--	pF
Open-Loop Gain	AVOL	-4.5V ≤ VOUT ≤ 4.5V	75	95	--	dB
<b>Output Characteristics</b>						
Output swing Low	VOL	IL = -5mA	--	-4.92	-4.85	V
Output swing High	VOH	IL = 5mA	4.85	4.92	--	V
Short Circuit current	ISCC		--	±120	--	mA
<b>Power Supply</b>						
Supply Voltage (Note 5)	VS		4.5	--	16.5	V
Power Supply Rejection Ratio	PSRR	VS is moved from ±2.25V to ±7.75V	60	70	--	dB
Supply Current/Amplifier	ISY	No Load	--	500	750	μA
<b>Dynamic Performance</b>						
Slew Rate (Note 6)	SR	-4V ≤ VOUT ≤ 4V, 20% to 80%	--	12	--	V/μs
Setting to ±0.1% (AV = 1)	ts	(AV = 1), VOUT = 2V step	--	500	--	ns
-3dB Bandwidth	BW	RL = 10kΩ, CL = 10 pF	--	12	--	MHz
Channel Separation	CS	f = 5MHz	--	75	--	dB

( $V_{S+} = 2.5V$ ,  $V_{S-} = -2.5V$ ,  $R_L = 10k\Omega$  and  $C_L = 10pF$ ,  $T_A = 25^\circ C$ , unless otherwise specified)

Parameter	Symbol	Test Conditions	Min	Typ	Max	Unit
<b>Input Characteristics</b>						
Input Offset Voltage	$V_{OS}$	$V_{CM} = 0V$	--	2	15	mV
Average Offset Voltage Drift	$\Delta V_{OS}/\Delta T$	$-40^\circ C \leq T_A \leq 85^\circ C$	--	5	--	$\mu V/^\circ C$
Input Bias Current	$I_B$	$V_{CM} = 0V$	--	2	50	nA
Input Impedance	$R_{IN}$		--	1	--	$G\Omega$
Input Capacitance	$C_{IN}$		--	1.35	--	pF
Open-Loop Gain	$A_{VOL}$	$0.5V \leq V_{OUT} \leq +4.5V$	75	95	--	dB
<b>Output Characteristics</b>						
Output swing Low	$V_{OL}$	$I_L = -5mA$	--	-2.42	-2.35	V
Output swing High	$V_{OH}$	$I_L = 5mA$	2.35	2.42	--	V
Short Circuit Current	$I_{SCC}$		--	$\pm 90$	--	mA
<b>Power Supply</b>						
Power Supply Rejection Ratio	PSRR	$V_S$ is moved from $\pm 2.25V$ to $\pm 7.75V$	50	70	--	dB
Supply Current/Amplifier	$I_{SY}$	No Load	--	500	750	$\mu A$
<b>Dynamic Performance</b>						
Slew Rate (Note 6)	SR	$-4V \leq V_{OUT} \leq 4V$ , 20% to 80%	--	12	--	$V/\mu s$
Setting to $\pm 0.1\%$ ( $A_V = 1$ )	$t_S$	( $A_V = 1$ ), $V_{OUT} = 2V$ step	--	500	--	ns
-3dB Bandwidth	BW	$R_L = 10k\Omega$ , $C_L = 10 pF$	--	12	--	MHz
Channel Separation	CS	$f = 5MHz$	--	75	--	dB

( $V_{S+} = 7.5V$ ,  $V_{S-} = -7.5V$ ,  $R_L = 10k\Omega$  and  $C_L = 10pF$ ,  $T_A = 25^\circ C$ , unless otherwise specified)

Parameter	Symbol	Test Conditions	Min	Typ	Max	Unit
<b>Input Characteristics</b>						
Input Offset Voltage	$V_{OS}$	$V_{CM} = 0V$	--	2	21	mV
Average Offset Voltage Drift	$\Delta V_{OS}/\Delta T$	$-40^\circ C \leq T_A \leq 85^\circ C$	--	5	--	$\mu V/^\circ C$
Input Bias Current	$I_B$	$V_{CM} = 0V$	--	2	50	nA
Input Impedance	$R_{IN}$		--	1	--	$G\Omega$
Input Capacitance	$C_{IN}$		--	1.35	--	pF
Open-Loop Gain	$A_{VOL}$	$0.5V \leq V_{OUT} \leq 4.5V$	75	95	--	dB
<b>Output Characteristics</b>						
Output swing Low	$V_{OL}$	$I_L = -5mA$	--	-4.92	-4.85	V
Output swing High	$V_{OH}$	$I_L = 5mA$	4.85	4.92	--	V
Short Circuit Current	$I_{SCC}$		--	$\pm 150$	--	mA
<b>Power Supply</b>						
Power Supply Rejection Ratio	PSRR	$V_S$ is moved from $\pm 2.25V$ to $\pm 7.75V$	50	70	--	dB
Supply Current/Amplifier	$I_{SY}$	No Load	--	500	850	$\mu A$
<b>Dynamic Performance</b>						
Slew Rate (Note 6)	SR	$-4V \leq V_{OUT} \leq 4V$ , 20% to 80%	--	20	--	$V/\mu s$
Setting to $\pm 0.1\%$ ( $A_V = 1$ )	$t_S$	( $A_V = 1$ ), $V_{OUT} = 2V$ step	--	500	--	ns
-3dB Bandwidth	BW	$R_L = 10k\Omega$ , $C_L = 10pF$	--	12	--	MHz
Channel Separation	CS	$f = 5MHz$	--	75	--	dB

**Note 1.** Stresses listed as the above "Absolute Maximum Ratings" may cause permanent damage to the device. These are for stress ratings. Functional operation of the device at these or any other conditions beyond those indicated in the operational sections of the specifications is not implied. Exposure to absolute maximum rating conditions for extended periods may remain possibility to affect device reliability.

**Note 2.**  $\theta_{JA}$  is measured in the natural convection at  $T_A = 25^\circ C$  on a high effective thermal conductivity test board (4-Layers, 2S2P) of JEDEC 51-7 thermal measurement standard.

**Note 3.** Devices are ESD sensitive. Handling precaution is recommended.

**Note 4.** The device is not guaranteed to function outside its operating conditions.

**Note 5.** 16.5V is the correct allowable aging voltage; however, full electrical characteristics are specified with a single nominal supply voltage from 5V to 15V or a split supply with its total range from 5V to 15V.

**Note 6.** Slew rate is measured on rising and falling edges.

Typical Operating Characteristics

Quiescent Current vs. Supply Voltage

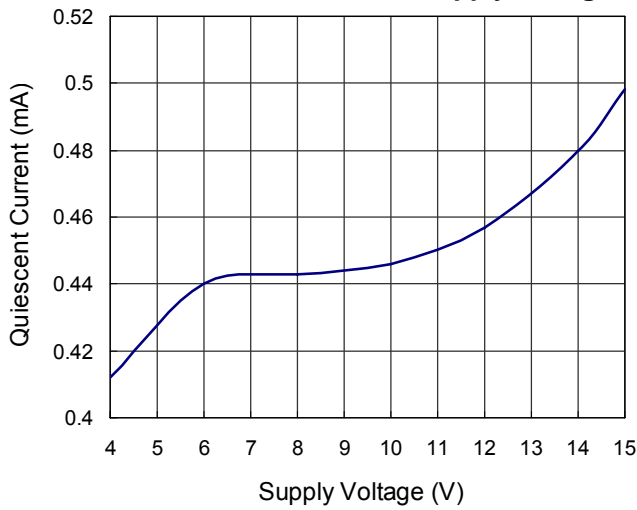

Quiescent Current vs. Temperature

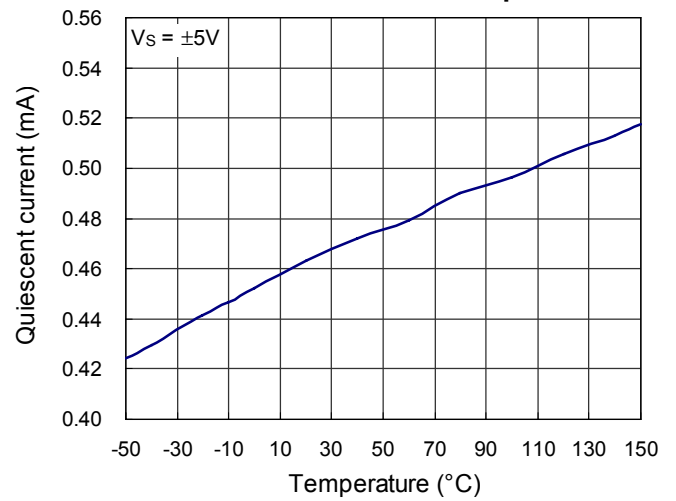

Output High Voltage vs. Temperature

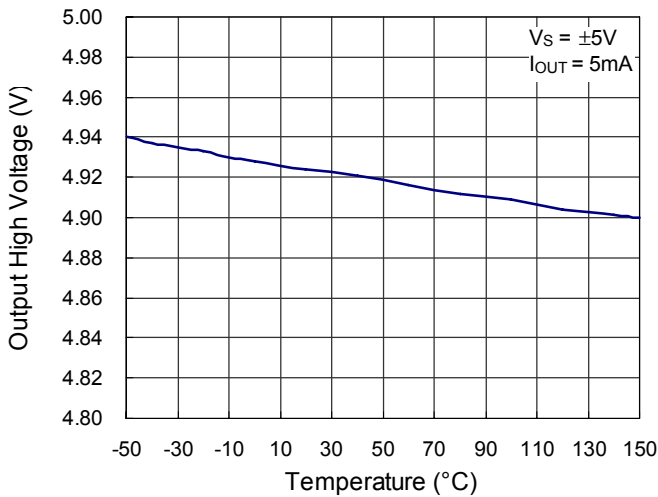

Output Low Voltage vs. Temperature

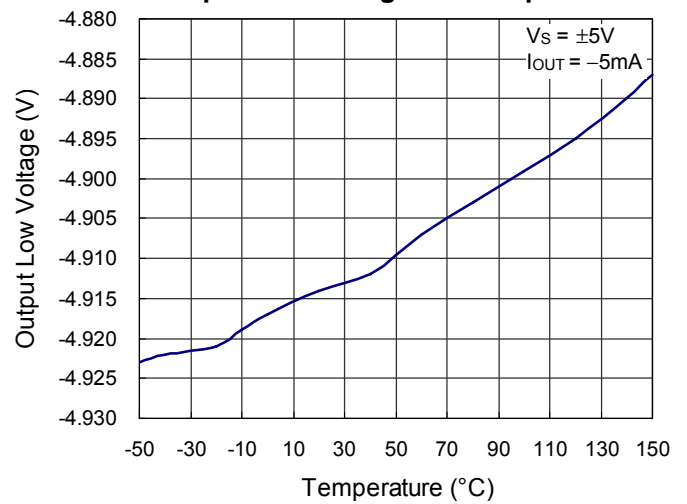

Slew Rate vs. Temperature

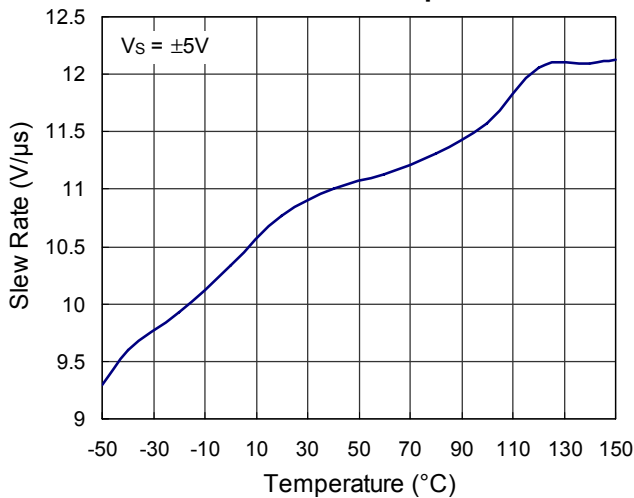

Frequency Response for Various  $R_L$

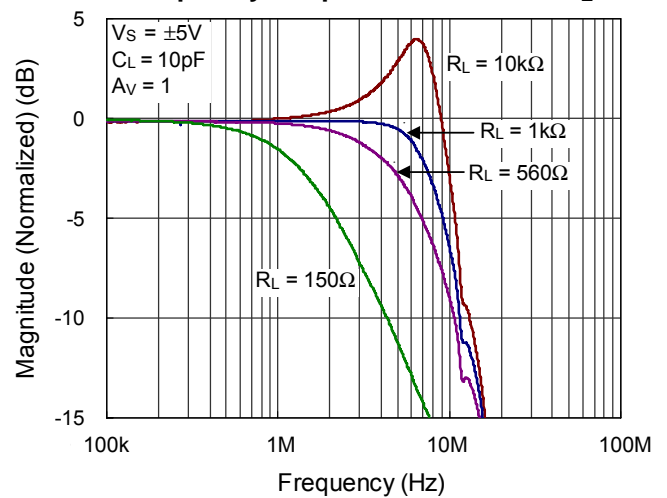

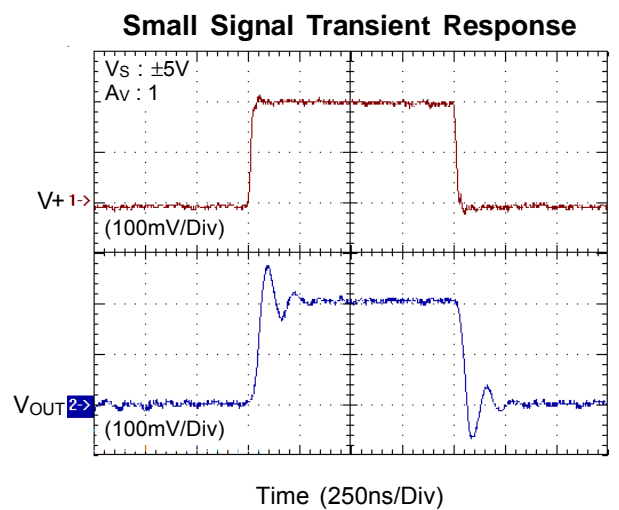
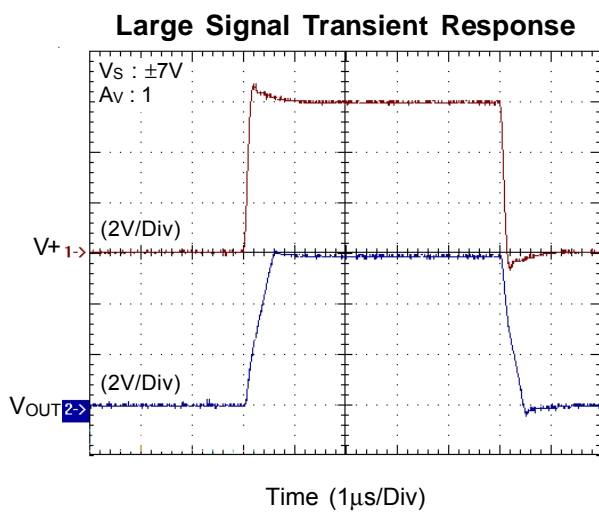
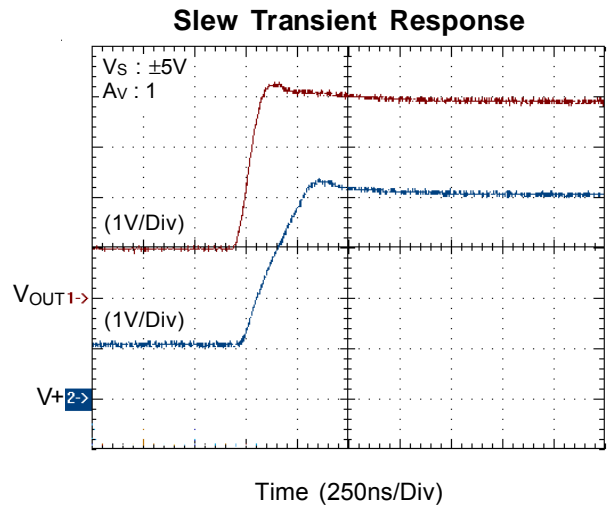
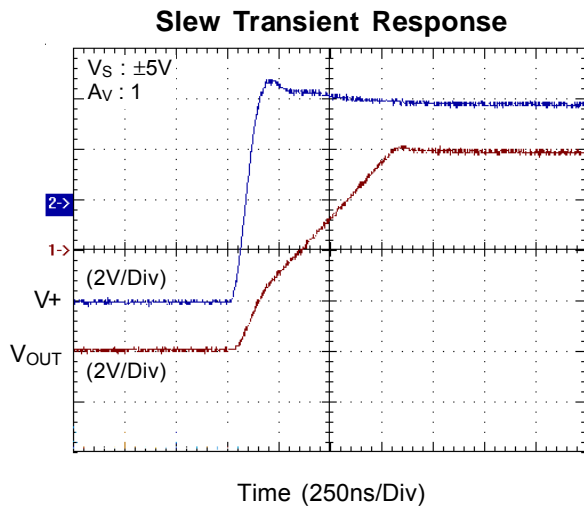
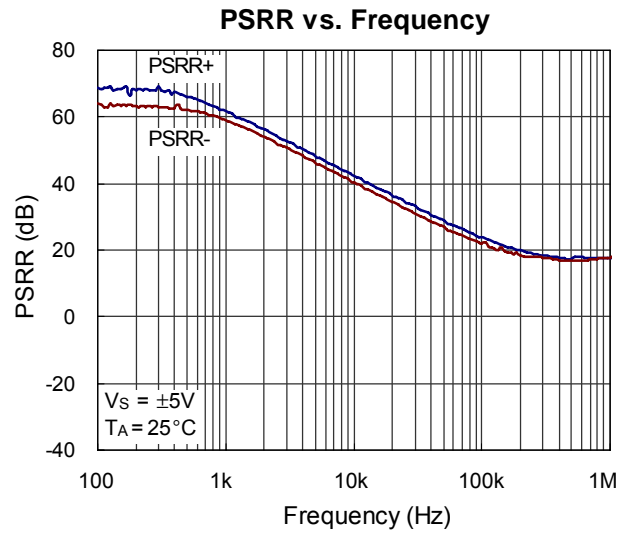
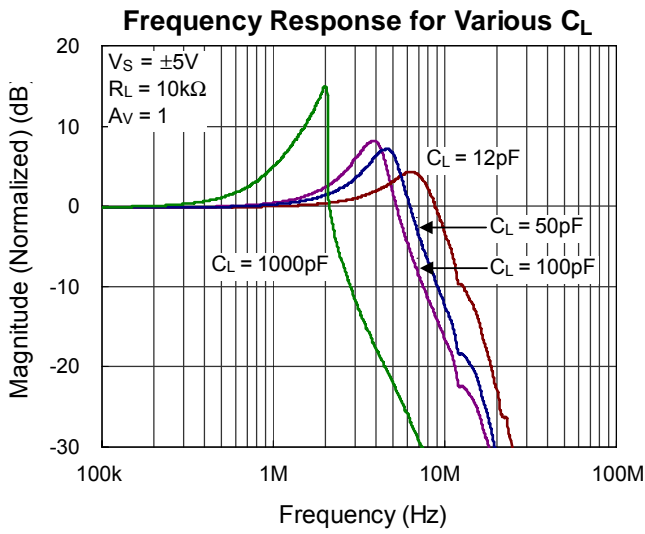

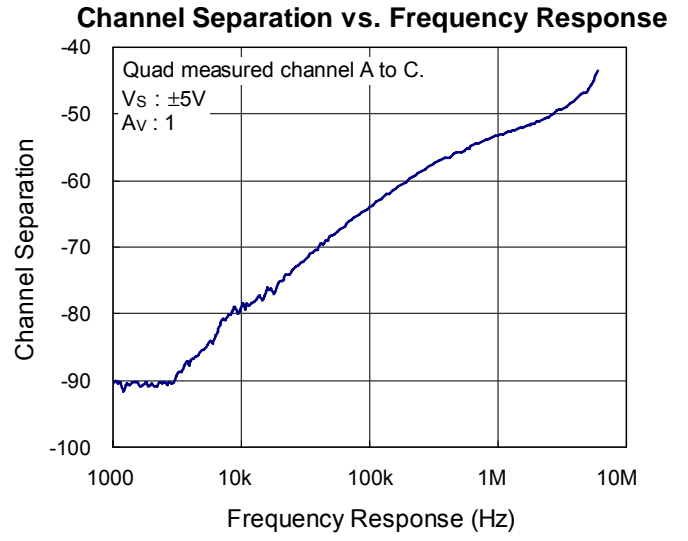
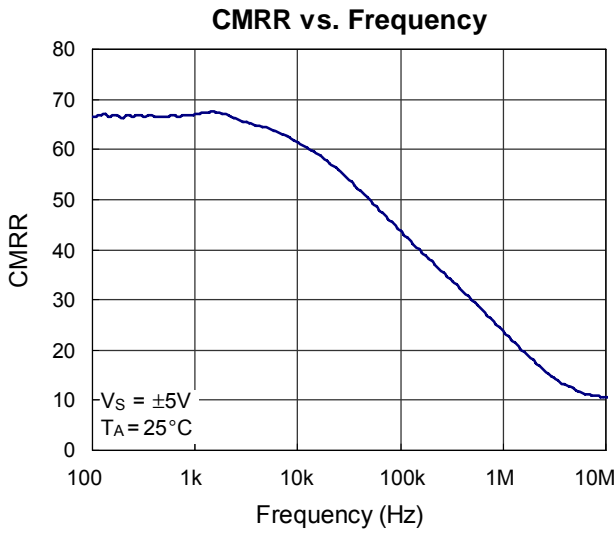



## Applications Information

The RT9136 packaged in quad operational amplifiers has high performance to drive large load for different application. High slew rates, rail-to-rail input and output capability and low power consumption are the features to make the RT9136 ideal for LCD applications. The RT9136 also has wide bandwidth and phase margin to drive a load of 10kΩ and 10pF.

### Operating Voltage

The RT9136 is specified with a single nominal supply voltage from 5V to 15V or a split supply with its total range from 5V to 15V. Correct operation is guaranteed for a supply range of 4.5V to 16.5V.

RT9136 specifications are stable over both the full supply range and operating temperatures of  $-40^{\circ}\text{C}$  to  $85^{\circ}\text{C}$ . Parameter variations with operating voltage and/or temperature are shown in the typical performance curves.

The output swing of the RT9136 typically extends to within 80mV of positive/negative supply rails with 5mA load current source/sink. Decreasing the load current will get output swing even closer to the supply rails. Figure 1 shows the rail-to-rail input and output waveforms in the unit gain configuration without load current. The supply rails are  $\pm 5\text{V}$ . Applying an input 10Vp\_p sinusoidal waveform results in a 9.8Vp\_p output voltage as shown in Figure 1.

### Short Circuit Condition

An internal short-circuit protection circuit is implemented to protect the device from output short circuit. The RT9136 limits the short circuit current to  $\pm 120\text{mA}$  if the output is directly shorted to positive/negative supply rails. For reliability, the continuous output current more than  $\pm 35\text{mA}$  is not recommended.

### Unused Amplifier

If the amplifier is unused. It is recommended to connect the positive input to ground and keep the output pin as open.

## LCD Panel Applications

The RT9136 is mainly designed for LCD gamma and V-com buffer. OP Amplifier-C has 120mA instantaneous source/sink peak current. To test the performance of the RT9136 for LCD driving capability, the test circuit is to simulate the V-com driver as shown Figure 2. Series capacitors and resistors connected to the output of the OP simulate the load of LCD panel. The 300Ω and 3kΩ feedback resistors are used to improve the settling time. This circuit is the worst case for a V-com buffer. Figure 3 shows the waveforms of the output peak current capability.

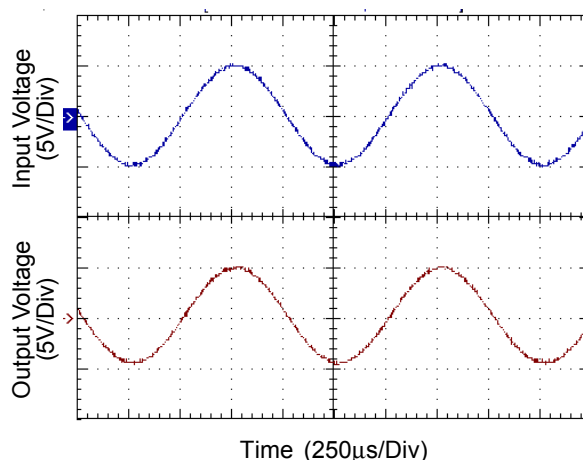

Figure 1. Operation with Rail-to-Rail Input and Output

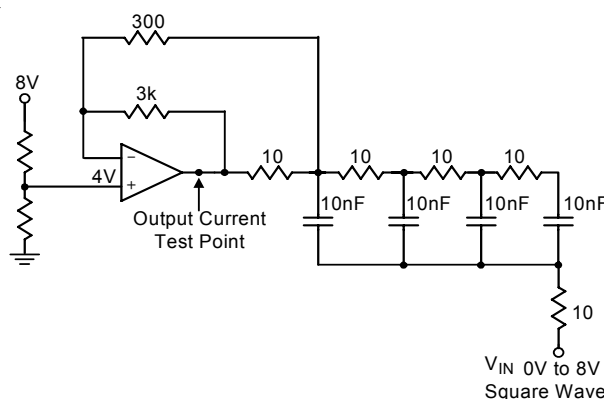

Figure 2. V-com Test Circuit

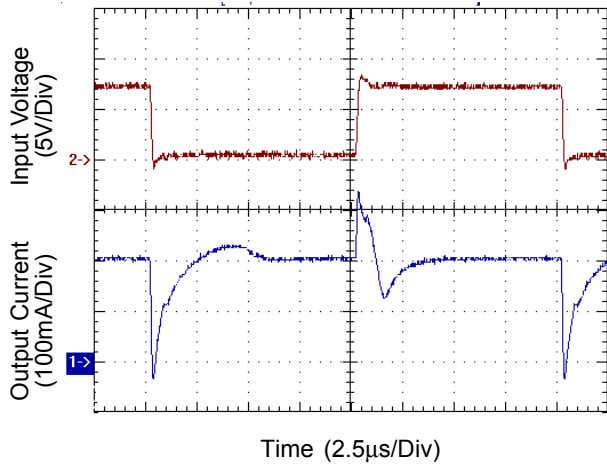
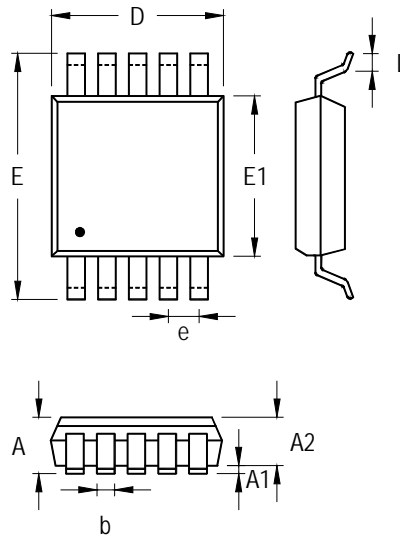

Figure 3. Scope Photo of the V-com Peak Current

**Outline Dimension**



Symbol	Dimensions In Millimeters		Dimensions In Inches	
	Min	Max	Min	Max
A	0.810	1.100	0.032	0.043
A1	0.000	0.150	0.000	0.006
A2	0.750	0.950	0.030	0.037
b	0.170	0.270	0.007	0.011
D	2.900	3.100	0.114	0.122
e	0.500		0.020	
E	4.800	5.000	0.189	0.197
E1	2.900	3.100	0.114	0.122
L	0.400	0.800	0.016	0.031

**10-Lead MSOP Plastic Package**

**Richtek Technology Corporation**

Headquarter  
 5F, No. 20, Taiyuen Street, Chupei City  
 Hsinchu, Taiwan, R.O.C.  
 Tel: (8863)5526789 Fax: (8863)5526611

**Richtek Technology Corporation**

Taipei Office (Marketing)  
 5F, No. 95, Minchiuan Road, Hsintien City  
 Taipei County, Taiwan, R.O.C.  
 Tel: (8862)86672399 Fax: (8862)86672377  
 Email: marketing@richtek.com

Information that is provided by Richtek Technology Corporation is believed to be accurate and reliable. Richtek reserves the right to make any change in circuit design, specification or other related things if necessary without notice at any time. No third party intellectual property infringement of the applications should be guaranteed by users when integrating Richtek products into any application. No legal responsibility for any said applications is assumed by Richtek.