

Data sheet | Item number: 2086-3104/700-000/997-605

SMD PCB terminal block; push-button; 1.5 mm²; Pin spacing 5 mm; 4-pole;
Push-in CAGE CLAMP®; 1,50 mm²; black

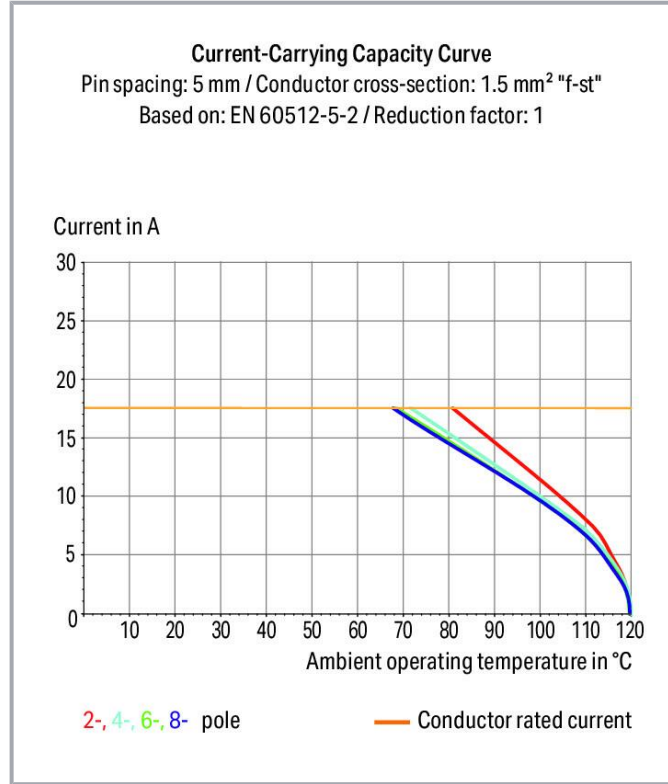

www.wago.com/2086-3104/700-000/997-605

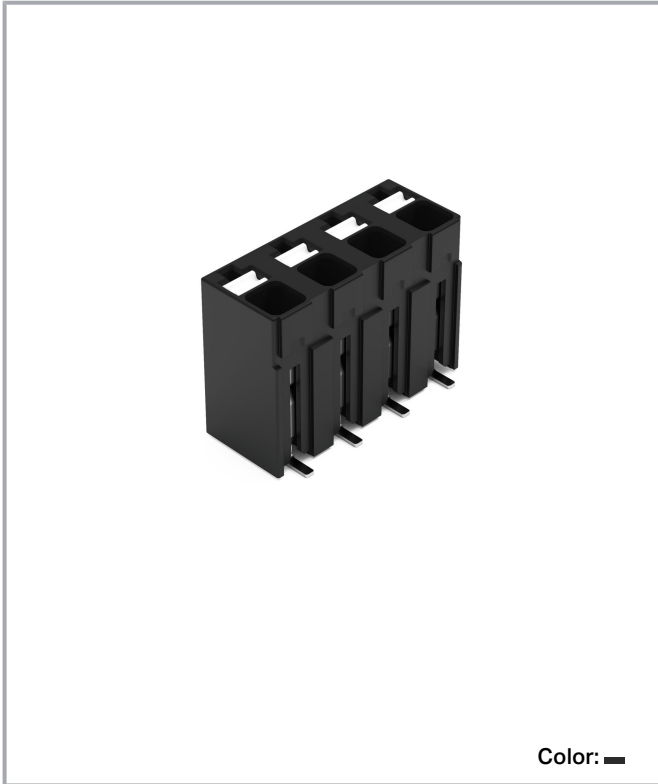

Subject to changes. Please also observe the further product documentation!

WAGO Corporation
Germantown, WI 53022
Phone: 1-800-DIN-RAIL (346-7245) | Fax: (262) 255-6222
Email: info.us@wago.com | Web: www.wago.us

Do you have any questions about our products?
We are always happy to take your call at (262) 255-6222 or 1 800-DIN-RAIL.

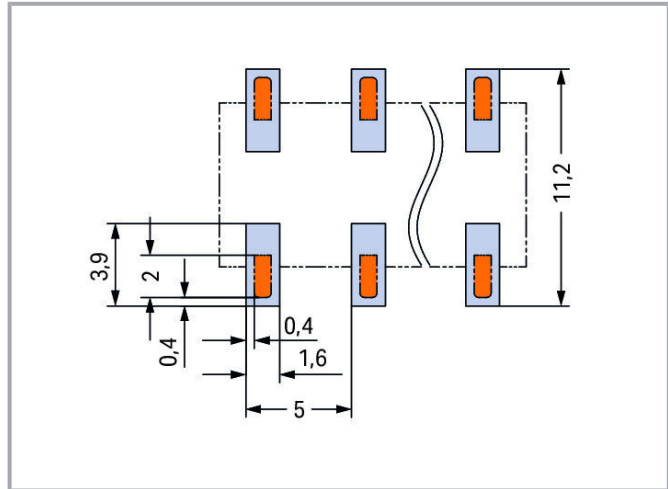

Dimensions in mm

$L = (\text{pole no.} - 1) \times \text{pin spacing} + 4.2 \text{ mm}$

Subject to changes. Please also observe the further product documentation!

WAGO Corporation
Germantown, WI 53022
Phone: 1-800-DIN-RAIL (346-7245) | Fax: (262) 255-6222
Email: info.us@wago.com | Web: www.wago.us

Do you have any questions about our products?
We are always happy to take your call at (262) 255-6222 or 1 800-DIN-RAIL.

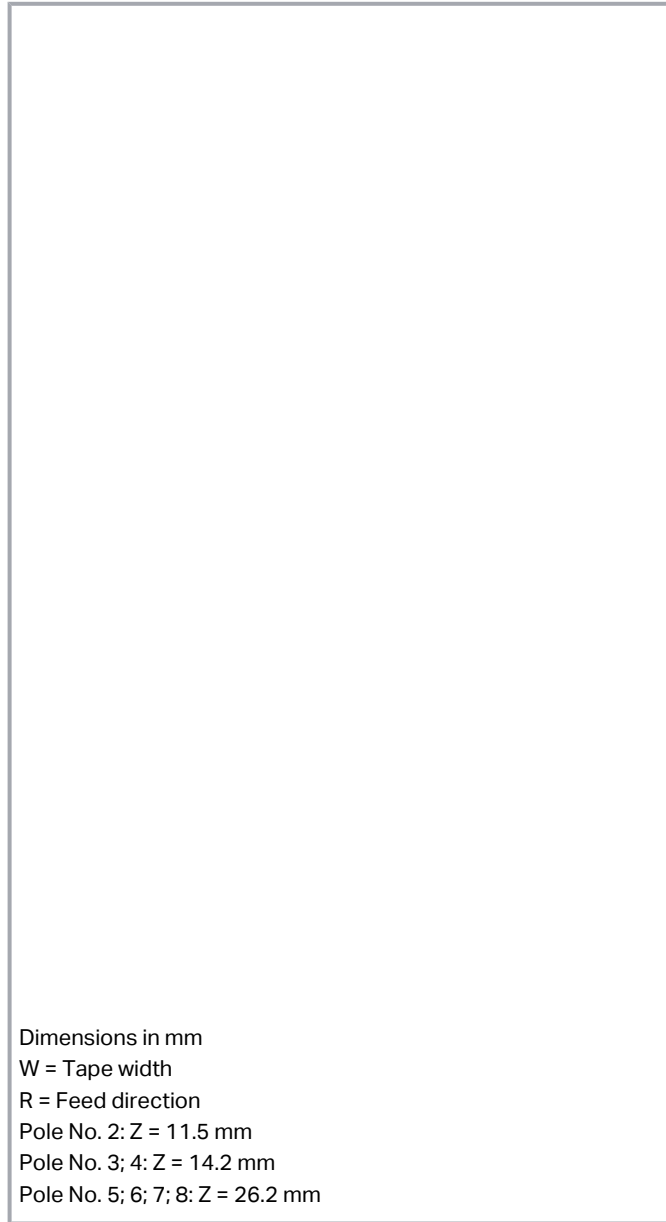

Dimensions in mm

W = Tape width

R = Feed direction

Pole No. 2: Z = 11.5 mm

Pole No. 3; 4: Z = 14.2 mm

Pole No. 5; 6; 7; 8: Z = 26.2 mm

Item description

- Ideal for compact device connection, panel feedthrough and tight spaces
- Push-in CAGE CLAMP® allows push-in termination of solid and fine-stranded conductors with ferrules
- SMD and THR variants available
- Delivery in tape-and-reel packaging for full integration into SMT soldering process
- Push-button moves in direction of conductor connection

—
Subject to changes. Please also observe the further product documentation!

WAGO Corporation
Germantown, WI 53022
Phone: 1-800-DIN-RAIL (346-7245) | Fax: (262) 255-6222
Email: info.us@wago.com | Web: www.wago.us

Do you have any questions about our products?
We are always happy to take your call at (262) 255-6222 or 1 800-DIN-RAIL.



- Conductor connection and mating direction both parallel and perpendicular to the PCB

Data

Electrical data

IEC Approvals

Ratings per	IEC/EN 60664-1
Rated voltage (III / 3)	320 V
Rated surge voltage (III/3)	4 kV
Rated voltage (III/2)	320 V
Rated surge voltage (III/2)	4 kV
Nominal voltage (II/2)	630 V
Rated surge voltage (II/2)	4 kV
Rated current	17.5 A
Legend (ratings)	(III / 2) ≙ Overvoltage category III / Pollution degree 2

UL Approvals

Approvals per	UL 1059
Rated voltage UL (Use Group B)	300 V
Rated current UL (Use Group B)	10 A
Rated voltage UL (Use Group C)	300 V
Rated current UL (Use Group C)	10 A
Rated voltage UL (Use Group D)	300 V
Rated current UL (Use Group D)	10 A

CSA Approvals

Approvals per	CSA
Rated voltage CSA (Use Group B)	300 V
Rated current CSA (Use Group B)	10 A
Rated voltage CSA (Use Group D)	300 V
Rated current CSA (Use Group D)	10 A

Connection data

Total number of potentials	4
Number of connection types	1
Number of levels	1

Subject to changes. Please also observe the further product documentation!

WAGO Corporation
 Germantown, WI 53022
 Phone: 1-800-DIN-RAIL (346-7245) | Fax: (262) 255-6222
 Email: info.us@wago.com | Web: www.wago.us

Do you have any questions about our products?
 We are always happy to take your call at (262) 255-6222 or 1 800-DIN-RAIL.



Connection 1

Connection technology	Push-in CAGE CLAMP®
Actuation type	Push-button
Solid conductor	0.14 ... 1.5 mm ² / 24 ... 16 AWG
Fine-stranded conductor	0.14 ... 1.5 mm ² / 24 ... 16 AWG
Fine-stranded conductor; with insulated ferrule	0.25 ... 0.75 mm ²
Fine-stranded conductor; with uninsulated ferrule	0.25 ... 1.5 mm ²
Strip length	8 ... 9 mm / 0.31 ... 0.35 inch
Conductor connection direction to PCB	90°
Number of poles	4

Physical data

Pin spacing	5 mm / 0.197 inch
Width	19.2 mm / 0.756 inch
Height	13.85 mm / 0.545 inch
Depth	7.8 mm / 0.307 inch
Reel diameter of tape-and-reel packaging	380 mm
Tape width	32 mm

PCB contact

PCB Contact	SMD
Solder pin arrangement	Over the entire terminal strip (in-line)
Number of solder pins per potential	2

Material data

Color	black
Insulation material	Polyphthalamide (PPA GF)
Clamping spring material	Chrome nickel spring steel (CrNi)
Contact material	Electrolytic copper (E _{Cu})
Contact plating	Tin-plated
Fire load	0.004 MJ
Weight	4.2 g

Environmental requirements

Limit temperature range	-60 ... +105 °C
-------------------------	-----------------

Subject to changes. Please also observe the further product documentation!

WAGO Corporation
Germantown, WI 53022
Phone: 1-800-DIN-RAIL (346-7245) | Fax: (262) 255-6222
Email: info.us@wago.com | Web: www.wago.us

Do you have any questions about our products?
We are always happy to take your call at (262) 255-6222 or 1 800-DIN-RAIL.



Commercial data











PU (SPU)	1890 (270) Stück
Packaging type	box
Country of origin	CH
GTIN	4055144108613
Customs tariff number	85369010000

Optional accessories

Tools

Operating tool		
	Item no.: 210-719 Operating tool; Blade: 2.5 x 0.4 mm; with a partially insulated shaft	www.wago.com/210-719

Ferrules

Ferrule		
	Item no.: 216-101 Ferrule; Sleeve for 0.5 mm ² / AWG 22; uninsulated; electro-tin plated; silver-colored	www.wago.com/216-101
	Item no.: 216-104 Ferrule; Sleeve for 1.5 mm ² / AWG 16; uninsulated; electro-tin plated; silver-colored	www.wago.com/216-104
	Item no.: 216-102 Ferrule; Sleeve for 0.75 mm ² / AWG 20; uninsulated; electro-tin plated; silver-colored	www.wago.com/216-102
	Item no.: 216-103 Ferrule; Sleeve for 1 mm ² / AWG 18; uninsulated; electro-tin plated	www.wago.com/216-103
	Item no.: 216-142 Ferrule; Sleeve for 0.75 mm ² / 18 AWG; uninsulated; electro-tin plated; electrolytic copper; gastight crimped; acc. to DIN 46228, Part 1/08.92	www.wago.com/216-142
	Item no.: 216-132 Ferrule; Sleeve for 0.34 mm ² / AWG 24; uninsulated; electro-tin plated	www.wago.com/216-132
	Item no.: 216-121 Ferrule; Sleeve for 0.5 mm ² / AWG 22; uninsulated; electro-tin plated; silver-colored	www.wago.com/216-121
	Item no.: 216-143 Ferrule; Sleeve for 1 mm ² / AWG 18; uninsulated; electro-tin plated; electrolytic copper; gastight crimped; acc. to DIN 46228, Part 1/08.92	www.wago.com/216-143
	Item no.: 216-131 Ferrule; Sleeve for 0.25 mm ² / AWG 24; uninsulated; electro-tin plated; silver-colored	www.wago.com/216-131
	Item no.: 216-141 Ferrule; Sleeve for 0.5 mm ² / 20 AWG; uninsulated; electro-tin plated; electrolytic copper; gastight crimped; acc. to DIN 46228, Part 1/08.92	www.wago.com/216-141
	Item no.: 216-152	

Subject to changes. Please also observe the further product documentation!









WAGO Corporation
Germantown, WI 53022
Phone: 1-800-DIN-RAIL (346-7245) | Fax: (262) 255-6222
Email: info.us@wago.com | Web: www.wago.us

Do you have any questions about our products?
We are always happy to take your call at (262) 255-6222 or 1 800-DIN-RAIL.





Ferrule; Sleeve for 0.34 mm² / AWG 24; uninsulated; electro-tin plated

www.wago.com/216-152

	Item no.: 216-202 Ferrule; Sleeve for 0.75 mm ² / 18 AWG; insulated; electro-tin plated; gray	www.wago.com/216-202
	Item no.: 216-151 Ferrule; Sleeve for 0.25 mm ² / AWG 24; uninsulated; electro-tin plated	www.wago.com/216-151
	Item no.: 216-144 Ferrule; Sleeve for 1.5 mm ² / AWG 16; uninsulated; electro-tin plated; electrolytic copper; gastight crimped; acc. to DIN 46228, Part 1/08.92; silver-colored	www.wago.com/216-144
	Item no.: 216-201 Ferrule; Sleeve for 0.5 mm ² / 20 AWG; insulated; electro-tin plated; white	www.wago.com/216-201
	Item no.: 216-241 Ferrule; Sleeve for 0.5 mm ² / 20 AWG; insulated; electro-tin plated; electrolytic copper; gastight crimped; acc. to DIN 46228, Part 4/09.90; white	www.wago.com/216-241
	Item no.: 216-242 Ferrule; Sleeve for 0.75 mm ² / 18 AWG; insulated; electro-tin plated; electrolytic copper; gastight crimped; acc. to DIN 46228, Part 4/09.90; gray	www.wago.com/216-242
	Item no.: 216-301 Ferrule; Sleeve for 0.25 mm ² / AWG 24; insulated; electro-tin plated; yellow	www.wago.com/216-301
	Item no.: 216-302 Ferrule; Sleeve for 0.34 mm ² / 22 AWG; insulated; electro-tin plated; green	www.wago.com/216-302

Testing accessories

Testing accessories		
	Item no.: 735-500 Test pin; 1 mm Ø; with solder connection for test wire	www.wago.com/735-500
	Item no.: 859-500 Test pin; 1 mm Ø; with solder connection for test wire	www.wago.com/859-500

Downloads

Documentation

Additional Information

Technical explanations	Apr 3, 2019	pdf 2.0 MB	Download
------------------------	-------------	---------------	----------

Environmental Product Compliance

Compliance Search

Environmental Product Compliance 2086-3104/700-000/997-605	URL	Download
--	-----	----------

Subject to changes. Please also observe the further product documentation!

WAGO Corporation
 Germantown, WI 53022
 Phone: 1-800-DIN-RAIL (346-7245) | Fax: (262) 255-6222
 Email: info.us@wago.com | Web: www.wago.us

Do you have any questions about our products?
 We are always happy to take your call at (262) 255-6222 or 1 800-DIN-RAIL.

SMD PCB terminal block; push-button; 1.5 mm²; Pin spacing 5 mm; 4-pole; Push-in
CAGE CLAMP®; 1,50 mm²; black

Installation Notes

Conductor termination



Inserting solid conductor via push-in
termination.

Conductor removal



Removing fine-stranded conductors via
push-buttons.

Conductor termination

Subject to changes. Please also observe the further product documentation!

WAGO Corporation
Germantown, WI 53022
Phone: 1-800-DIN-RAIL (346-7245) | Fax: (262) 255-6222
Email: info.us@wago.com | Web: www.wago.us

Do you have any questions about our products?
We are always happy to take your call at (262) 255-6222 or 1 800-DIN-RAIL.



Inserting and removing fine-stranded conductors via push-buttons.

Testing

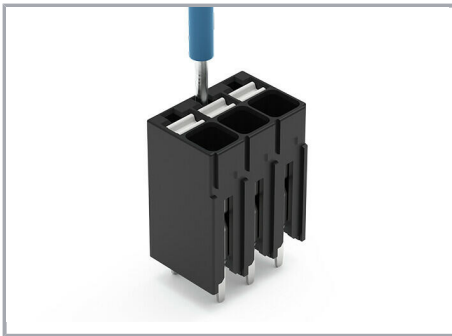

Testing via 1 mm Ø test pin.

Touch contact with current bar.

Marking



Pole marking via direct marking perpendicular to conductor entry.

Subject to changes. Please also observe the further product documentation!