

PART NUMBER **5718L-01P-HP50**

**MOTOR SPECIFICATIONS**

Part Number	<b>5718L-01P</b>
Step Angle	1.8°
Frame Size	NEMA 23
Body Length (Dim. A)	3.1 in. (78.7 mm)
Current	2.8 Amps/Phase
Holding Torque	294 oz-in (2.08 Nm)
Resistance	1.1 Ohms/Phase
Rotor Inertia	2.6 oz-in <sup>2</sup>
Number of Leads	4
Lead length	24 in. (609.6 mm)
Connection	Parallel
Weight	2.35 lbs (1.07 kg)

**GEARBOX SPECIFICATIONS**

Part Number	<b>HP50</b>
Ratio	50:1
Nominal Output Torque (Nm)	50
Emergency Stop Torque (Nm)	3 times nominal output torque
Nominal Input Speed (RPM)	5000
Max Input Speed (RPM)	10000
Max Radial Load (N)	1377
Max Axial Load (N)	765
Efficiency $\eta$ (%)	85
Backlash (arcmin)	<7
Protection Class	IP65 (gearbox), IP40 (motor)
Service Life (hr)	20000
Weight (kg)	1.6
Operating Temperature (°C)	-20 to 90
Lubrication	Grease
Noise (n=3000 rpm) dB(A)	58
Mass Movement of Inertia (kg-cm <sup>2</sup> )	0.03



**PERFORMANCE CURVE**

**5718L-01P GEARMOTOR TORQUE CURVES**

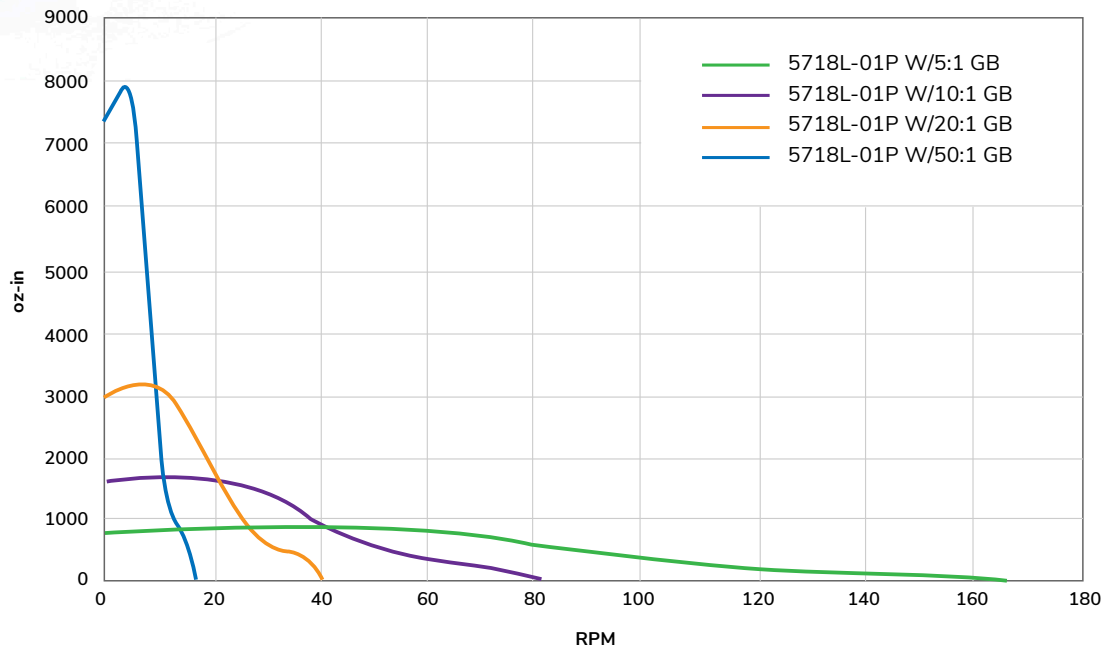

## DIMENSIONS

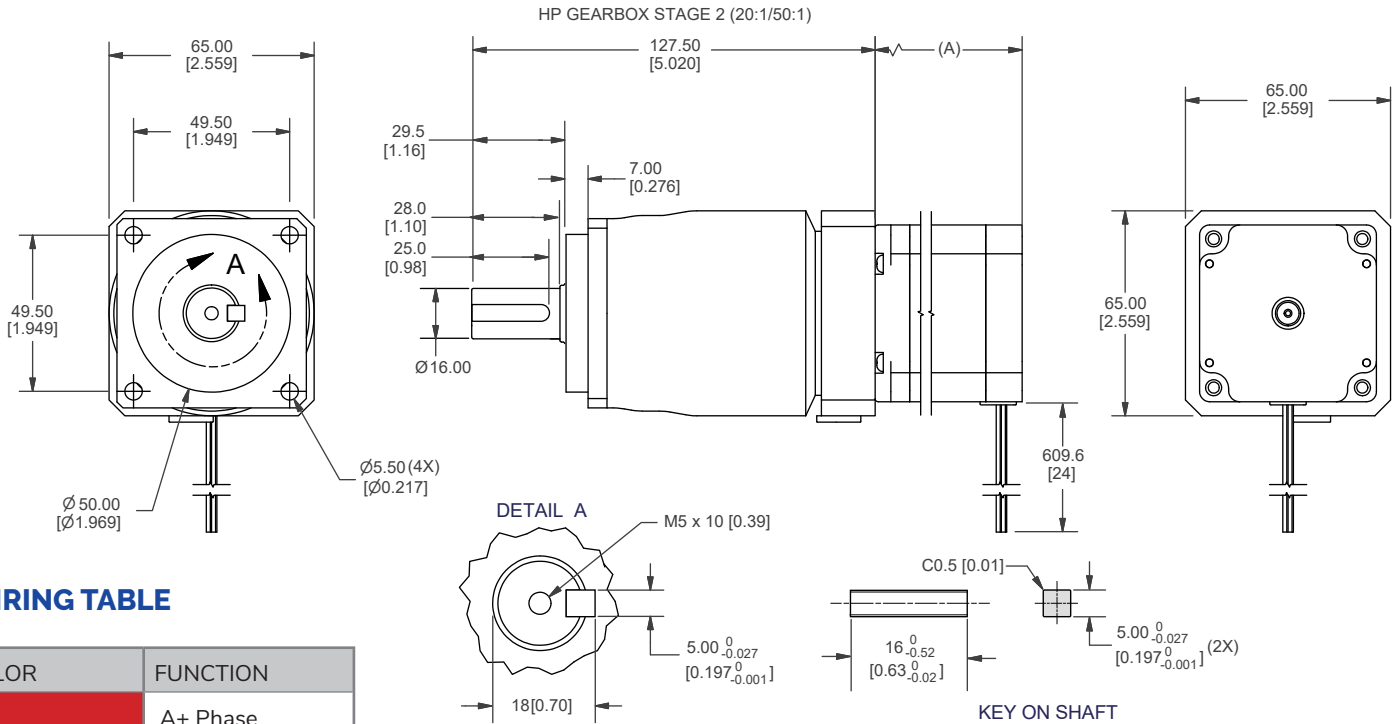

## WIRING TABLE

COLOR	FUNCTION
Red	A+ Phase
Blue	A- Phase
Green	B + Phase
Black	B- Phase

## RECOMMENDED PRODUCTS



MICROSTEPPING DRIVER  
R701P-RO



HIGH RESOLUTION  
STEPPER DRIVER  
R725-RO

## OPERATION & USAGE TIPS

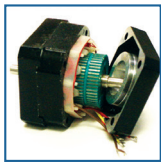

**Do not** disassemble motors; a significant reduction in motor performance will occur.

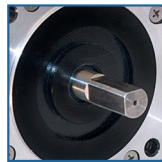

**Do not** machine shafts; this will have a negative effect on shaft run out and perpendicularity.

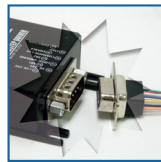

**Do not** disconnect motor from drive while in operation.

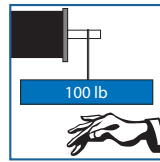

**Do not** use holding torque/detent torque of motor as a fail safe brake.

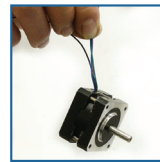

**Do not** hold motor by lead wires.



**Do not** exceed the rated current; this will damage the motor.

FAILURE TO COMPLY WITH THESE RECOMMENDATIONS WILL VOID ALL WARRANTY TERMS

# Motion Control, Solved.

## MOTOR ENGINEERING & MANUFACTURING



Optimized  
For Your  
Application



Quick  
Prototype  
Turnaround



Small Batch  
to OEM Volume  
Production



US Based  
Support &  
Manufacturing