

## Low Offset, Low Noise, RRO Operational Amplifier

Check for Samples: [SM73308](#)

### FEATURES

(Unless Otherwise Noted, Typical Values at  $V_S = 2.7V$ )

- Renewable Energy Grade
- Ensured 2.7V and 5V Specifications
- Maximum  $V_{OS}$  850 $\mu V$  (Limit)
- Voltage noiseN
  - $f = 100$  Hz 12.5nV/ $\sqrt{Hz}$
  - $f = 10$  kHz 7.5nV/ $\sqrt{Hz}$
- Rail-to-Rail Output Swing
  - $R_L = 600\Omega$  100mV From Rail
  - $R_L = 2k\Omega$  50mV From Rail
- Open Loop Gain With  $R_L = 2k\Omega$  100dB
- $V_{CM}$  0 to  $V^+ - 0.9V$
- Supply Current 550 $\mu A$
- Gain Bandwidth Product 3.5MHz
- Temperature Range  $-40^\circ C$  to  $125^\circ C$

### APPLICATIONS

- Transducer Amplifier
- Instrumentation Amplifier
- Precision Current Sensing
- Data Acquisition Systems
- Active Filters and Buffers
- Sample and Hold
- Portable/battery Powered Electronics
- Automotive

### Connection Diagram

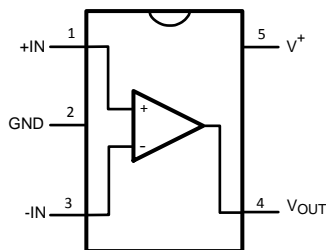

**Figure 1. SC70-5 – Top View**  
See Package Number DCK

### DESCRIPTION

The SM73308 is a single low noise precision operational amplifier intended for use in a wide range of applications. Other important characteristics include: an extended operating temperature range of  $-40^\circ C$  to  $125^\circ C$ , the tiny SC70-5 package, and low input bias current.

The extended temperature range of  $-40^\circ C$  to  $125^\circ C$  allows the SM73308 to accommodate a broad range of applications. The SM73308 expands TI's Silicon Dust™ amplifier portfolio offering enhancements in size, speed, and power savings. The SM73308 is ensured to operate over the voltage range of 2.7V to 5.0V and has rail-to-rail output.

The SM73308 is designed for precision, low noise, low voltage, and miniature systems. This amplifier provides rail-to-rail output swing into heavy loads. The maximum input offset is 850  $\mu V$  at room temperature and the input common mode voltage range includes ground.

The SM73308 is offered in the tiny SC70-5 package.



Please be aware that an important notice concerning availability, standard warranty, and use in critical applications of Texas Instruments semiconductor products and disclaimers thereto appears at the end of this data sheet.

Silicon Dust is a trademark of Texas Instruments.

All other trademarks are the property of their respective owners.

## Instrumentation Amplifier

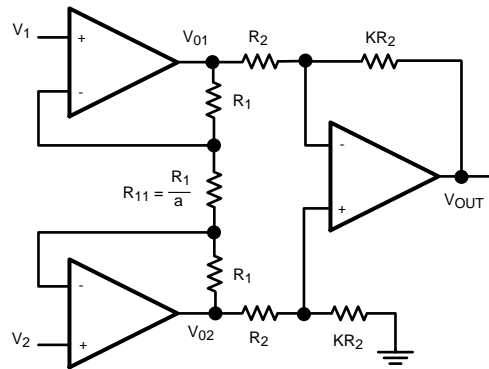

$$V_O = -K(2a + 1)(V_1 - V_2) \quad (1)$$



These devices have limited built-in ESD protection. The leads should be shorted together or the device placed in conductive foam during storage or handling to prevent electrostatic damage to the MOS gates.

### Absolute Maximum Ratings<sup>(1)(2)</sup>

ESD Tolerance <sup>(3)</sup>	Machine Model	200V
	Human Body Model	2000V
Differential Input Voltage		± Supply Voltage
Voltage at Input Pins		(V <sup>+</sup> ) + 0.3V, (V <sup>-</sup> ) - 0.3V
Current at Input Pins		±10 mA
Supply Voltage (V <sup>+</sup> -V <sup>-</sup> )		5.75V
Output Short Circuit to V <sup>+</sup>		See <sup>(4)</sup>
Output Short Circuit to V <sup>-</sup>		See <sup>(5)</sup>
Mounting Temperature	Infrared or Convection (20 sec)	235°C
	Wave Soldering Lead Temp (10 sec)	260°C
Storage Temperature Range		-65°C to 150°C
Junction Temperature <sup>(6)</sup>		150°C

- (1) Absolute Maximum Ratings indicate limits beyond which damage to the device may occur. Operating Ratings indicate conditions for which the device is intended to be functional, but specific performance is not ensured. For ensured specifications and the test conditions, see the Electrical Characteristics.
- (2) If Military/Aerospace specified devices are required, please contact the Texas Instruments Sales Office/ Distributors for availability and specifications.
- (3) Human Body Model is 1.5 kΩ in series with 100 pF. Machine Model is 0Ω in series with 20 pF.
- (4) Shorting output to V<sup>+</sup> will adversely affect reliability.
- (5) Shorting output to V<sup>-</sup> will adversely affect reliability.
- (6) The maximum power dissipation is a function of T<sub>J(MAX)</sub>, θ<sub>JA</sub>, and T<sub>A</sub>. The maximum allowable power dissipation at any ambient temperature is P<sub>D</sub> = (T<sub>J(MAX)</sub> - T<sub>A</sub>) / θ<sub>JA</sub>. All numbers apply for packages soldered directly into a PC board.

### Operating Ratings<sup>(1)</sup>

Supply Voltage	2.7V to 5.5V
Temperature Range	-40°C to 125°C
Thermal Resistance (θ <sub>JA</sub> )	440 °C/W

- (1) Absolute Maximum Ratings indicate limits beyond which damage to the device may occur. Operating Ratings indicate conditions for which the device is intended to be functional, but specific performance is not ensured. For ensured specifications and the test conditions, see the Electrical Characteristics.

## 2.7V DC Electrical Characteristics<sup>(1)</sup>

Unless otherwise specified, all limits are ensured for  $T_A = 25^\circ\text{C}$ .  $V^+ = 2.7\text{V}$ ,  $V^- = 0\text{V}$ ,  $V_{\text{CM}} = V^+/2$ ,  $V_O = V^+/2$  and  $R_L > 1\text{M}\Omega$ .

**Boldface** limits apply at the temperature extremes.

Symbol	Parameter	Condition	Min <sup>(2)</sup>	Typ <sup>(3)</sup>	Max <sup>(2)</sup>	Units
$V_{\text{OS}}$	Input Offset Voltage			0.3	0.85 <b>1.0</b>	mV
$\text{TCV}_{\text{OS}}$	Input Offset Voltage Average Drift			-0.45		$\mu\text{V}/^\circ\text{C}$
$I_B$	Input Bias Current <sup>(4)</sup>	$V_{\text{CM}} = 1\text{V}$		-0.1	100 <b>250</b>	$\mu\text{A}$
$I_{\text{OS}}$	Input Offset Current <sup>(4)</sup>			0.004	100	$\mu\text{A}$
$I_S$	Supply Current			550	900 <b>910</b>	$\mu\text{A}$
CMRR	Common Mode Rejection Ratio	$0.5 \leq V_{\text{CM}} \leq 1.2\text{V}$	74 <b>72</b>	80		dB
PSSR	Power Supply Rejection Ratio	$2.7\text{V} \leq V^+ \leq 5\text{V}$	82 <b>76</b>	90		dB
$V_{\text{CM}}$	Input Common-Mode Voltage Range	For CMRR $\geq 50\text{dB}$	0		1.8	V
$A_V$	Large Signal Voltage Gain <sup>(5)</sup>	$R_L = 600\Omega$ to $1.35\text{V}$ , $V_O = 0.2\text{V}$ to $2.5\text{V}$	92 <b>80</b>	100		dB
		$R_L = 2\text{k}\Omega$ to $1.35\text{V}$ , $V_O = 0.2\text{V}$ to $2.5\text{V}$	98 <b>86</b>	100		
$V_O$	Output Swing	$R_L = 600\Omega$ to $1.35\text{V}$ $V_{\text{IN}} = \pm 100\text{mV}$	0.11 <b>0.14</b>	0.084 to 2.62	2.59 <b>2.56</b>	V
		$R_L = 2\text{k}\Omega$ to $1.35\text{V}$ $V_{\text{IN}} = \pm 100\text{mV}$	0.05 <b>0.06</b>	0.026 to 2.68	2.65 <b>2.64</b>	
$I_O$	Output Short Circuit Current	Sourcing, $V_O = 0\text{V}$ $V_{\text{IN}} = 100\text{mV}$	18 <b>11</b>	24		mA
		Sinking, $V_O = 2.7\text{V}$ $V_{\text{IN}} = -100\text{mV}$	18 <b>11</b>	22		

(1) Electrical Table values apply only for factory testing conditions at the temperature indicated. Factory testing conditions result in very limited self-heating of the device such that  $T_J = T_A$ .

(2) All limits are ensured by testing or statistical analysis.

(3) Typical values represent the most likely parametric norm.

(4) Limits ensured by design.

(5)  $R_L$  is connected to mid-supply. The output voltage is set at 200mV from the rails.  $V_O = \text{GND} + 0.2\text{V}$  and  $V_O = V^+ - 0.2\text{V}$

## 2.7V AC Electrical Characteristics<sup>(1)</sup>

Unless otherwise specified, all limits are ensured for  $T_A = 25^\circ\text{C}$ .  $V^+ = 5.0\text{V}$ ,  $V^- = 0\text{V}$ ,  $V_{\text{CM}} = V^+/2$ ,  $V_O = V^+/2$  and  $R_L > 1\text{M}\Omega$ .

**Boldface** limits apply at the temperature extremes.

Symbol	Parameter	Conditions	Min <sup>(2)</sup>	Typ <sup>(3)</sup>	Max <sup>(2)</sup>	Units
SR	Slew Rate <sup>(4)</sup>	$A_V = +1$ , $R_L = 10\text{ k}\Omega$		1.4		$\text{V}/\mu\text{s}$
GBW	Gain-Bandwidth Product			3.5		MHz
$\Phi_m$	Phase Margin			79		Deg
$G_m$	Gain Margin			-15		dB
$e_n$	Input-Referred Voltage Noise (Flatband)	$f = 10\text{kHz}$		7.5		$\text{nV}/\sqrt{\text{Hz}}$
$e_n$	Input-Referred Voltage Noise (1/f)	$f = 100\text{Hz}$		12.5		$\text{nV}/\sqrt{\text{Hz}}$
$i_n$	Input-Referred Current Noise	$f = 1\text{kHz}$		0.001		$\text{pA}/\sqrt{\text{Hz}}$
THD	Total Harmonic Distortion	$f = 1\text{kHz}$ , $A_V = +1$ $R_L = 600\Omega$ , $V_{\text{IN}} = 1\text{ V}_{\text{PP}}$		0.007		%

(1) Electrical Table values apply only for factory testing conditions at the temperature indicated. Factory testing conditions result in very limited self-heating of the device such that  $T_J = T_A$ .

(2) All limits are ensured by testing or statistical analysis.

(3) Typical values represent the most likely parametric norm.

(4) The number specified is the slower of positive and negative slew rates.

## 5.0V DC Electrical Characteristics <sup>(1)</sup>

Unless otherwise specified, all limits are ensured for  $T_A = 25^\circ\text{C}$ .  $V^+ = 5.0\text{V}$ ,  $V^- = 0\text{V}$ ,  $V_{\text{CM}} = V^+/2$ ,  $V_O = V^+/2$  and  $R_L > 1\text{M}\Omega$ .

**Boldface** limits apply at the temperature extremes.

Symbol	Parameter	Condition	Min <sup>(2)</sup>	Typ <sup>(3)</sup>	Max <sup>(2)</sup>	Units
$V_{\text{OS}}$	Input Offset Voltage			0.25	0.85 <b>1.0</b>	mV
$\text{TCV}_{\text{OS}}$	Input Offset Voltage Average Drift			-0.35		$\mu\text{V}/^\circ\text{C}$
$I_B$	Input Bias Current <sup>(4)</sup>	$V_{\text{CM}} = 1\text{V}$		-0.23	100 <b>250</b>	$\mu\text{A}$
$I_{\text{OS}}$	Input Offset Current <sup>(4)</sup>			0.017	100	$\mu\text{A}$
$I_S$	Supply Current			600	950 <b>960</b>	$\mu\text{A}$
CMRR	Common Mode Rejection Ratio	$0.5 \leq V_{\text{CM}} \leq 3.5\text{V}$	80 <b>79</b>	90		dB
PSRR	Power Supply Rejection Ratio	$2.7\text{V} \leq V^+ \leq 5\text{V}$	82 <b>76</b>	90		dB
$V_{\text{CM}}$	Input Common-Mode Voltage Range	For CMRR $\geq 50\text{dB}$	0		4.1	V
$A_V$	Large Signal Voltage Gain <sup>(5)</sup>	$R_L = 600\Omega$ to 2.5V, $V_O = 0.2\text{V}$ to 4.8V	92 <b>89</b>	100		dB
		$R_L = 2\text{k}\Omega$ to 2.5V, $V_O = 0.2\text{V}$ to 4.8V	98 <b>95</b>	100		
$V_O$	Output Swing	$R_L = 600\Omega$ to 2.5V $V_{\text{IN}} = \pm 100\text{mV}$	0.15 <b>0.23</b>	0.112 to 4.9	4.85 <b>4.77</b>	V
		$R_L = 2\text{k}\Omega$ to 2.5V $V_{\text{IN}} = \pm 100\text{mV}$	0.06 <b>0.07</b>	0.035 to 4.97	4.94 <b>4.93</b>	
$I_O$	Output Short Circuit Current <sup>(4)(6)</sup>	Sourcing, $V_O = 0\text{V}$ $V_{\text{IN}} = 100\text{mV}$	35 <b>35</b>	75		mA
		Sinking, $V_O = 2.7\text{V}$ $V_{\text{IN}} = -100\text{mV}$	35 <b>35</b>	66		

(1) Electrical Table values apply only for factory testing conditions at the temperature indicated. Factory testing conditions result in very limited self-heating of the device such that  $T_J = T_A$ .

(2) All limits are ensured by testing or statistical analysis.

(3) Typical values represent the most likely parametric norm.

(4) Limits ensured by design.

(5)  $R_L$  is connected to mid-supply. The output voltage is set at 200mV from the rails.  $V_O = \text{GND} + 0.2\text{V}$  and  $V_O = V^+ - 0.2\text{V}$

(6) Continuous operation of the device with an output short circuit current larger than 35mA may cause permanent damage to the device.

## 5.0V AC Electrical Characteristics <sup>(1)</sup>

Unless otherwise specified, all limits are ensured for  $T_A = 25^\circ\text{C}$ .  $V^+ = 5.0\text{V}$ ,  $V^- = 0\text{V}$ ,  $V_{\text{CM}} = V^+/2$ ,  $V_O = V^+/2$  and  $R_L > 1\text{M}\Omega$ .

**Boldface** limits apply at the temperature extremes.

Symbol	Parameter	Conditions	Min <sup>(2)</sup>	Typ <sup>(3)</sup>	Max <sup>(2)</sup>	Units
SR	Slew Rate <sup>(4)</sup>	$A_V = +1$ , $R_L = 10\text{ k}\Omega$		1.4		$\text{V}/\mu\text{s}$
GBW	Gain-Bandwidth Product			3.5		MHz
$\Phi_m$	Phase Margin			79		Deg
$G_m$	Gain Margin			-15		dB
$e_n$	Input-Referred Voltage Noise (Flatband)	$f = 10\text{kHz}$		6.5		$\text{nV}/\sqrt{\text{Hz}}$
$e_n$	Input-Referred Voltage Noise (1/f)	$f = 100\text{Hz}$		12		$\text{nV}/\sqrt{\text{Hz}}$
$i_n$	Input-Referred Current Noise	$f = 1\text{kHz}$		0.001		$\text{pA}/\sqrt{\text{Hz}}$
THD	Total Harmonic Distortion	$f = 1\text{kHz}$ , $A_V = +1$ $R_L = 600\Omega$ , $V_{\text{IN}} = 1\text{ V}_{\text{PP}}$		0.007		%

(1) Electrical Table values apply only for factory testing conditions at the temperature indicated. Factory testing conditions result in very limited self-heating of the device such that  $T_J = T_A$ .

(2) All limits are ensured by testing or statistical analysis.

(3) Typical values represent the most likely parametric norm.

(4) The number specified is the slower of positive and negative slew rates.

Typical Performance Characteristics

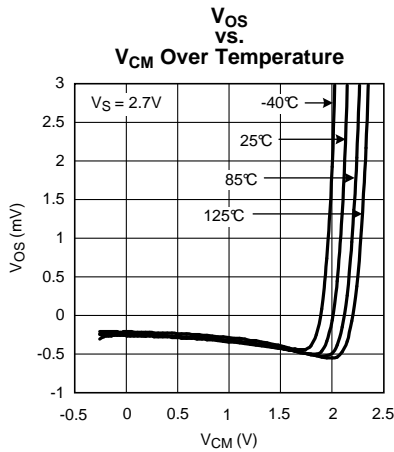

Figure 2.

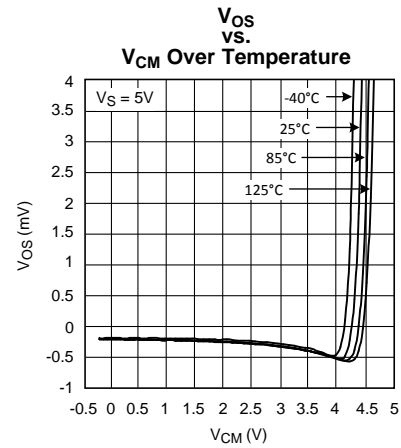

Figure 3.

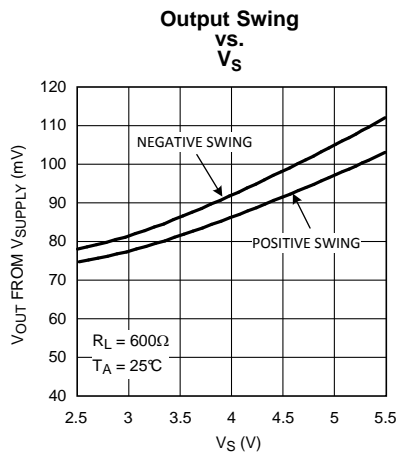

Figure 4.

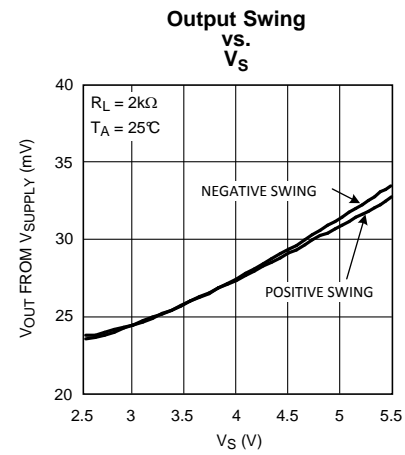

Figure 5.

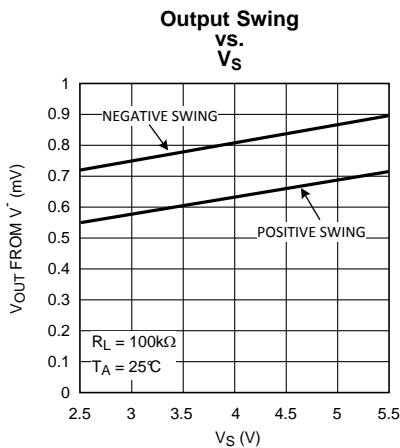

Figure 6.

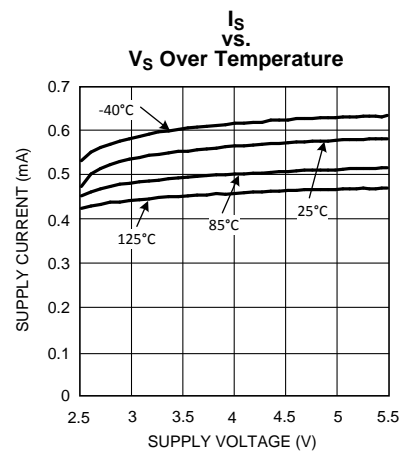

Figure 7.

Typical Performance Characteristics (continued)

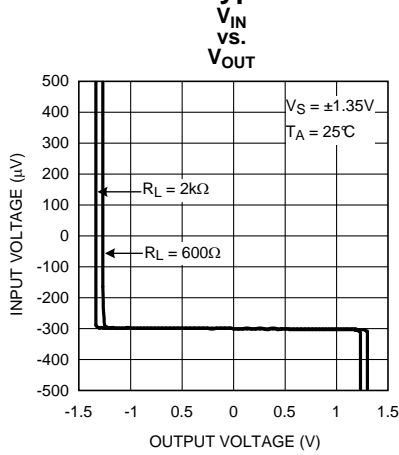

Figure 8.

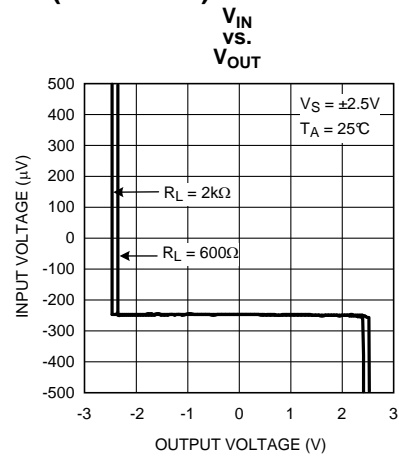

Figure 9.

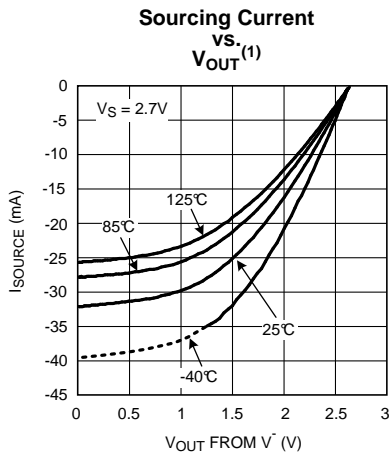

Figure 10.

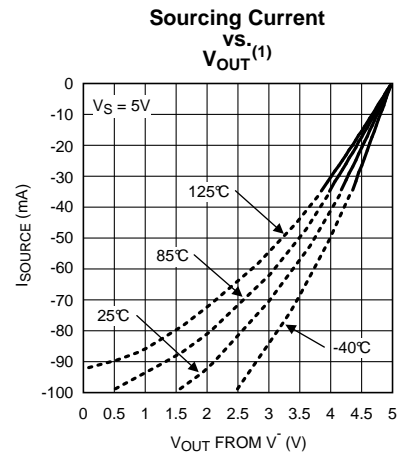

Figure 11.

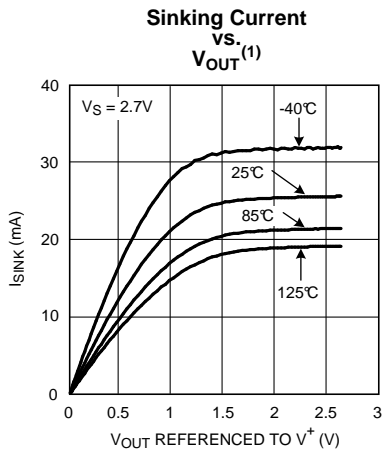

Figure 12.

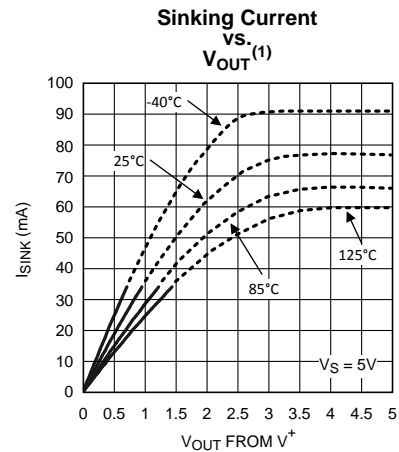

Figure 13.

(1) Continuous operation of the device with an output short circuit current larger than 35mA may cause permanent damage to the device.

**Typical Performance Characteristics (continued)**  
**Input Voltage Noise vs. Frequency**

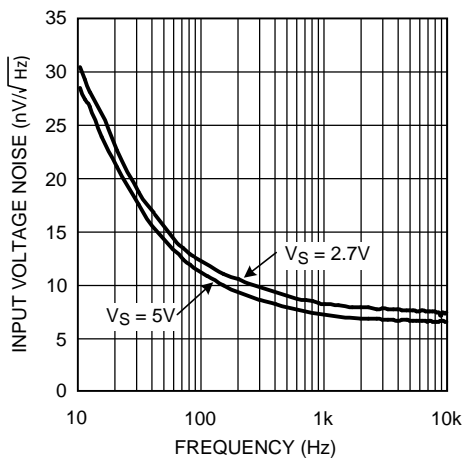

Figure 14.

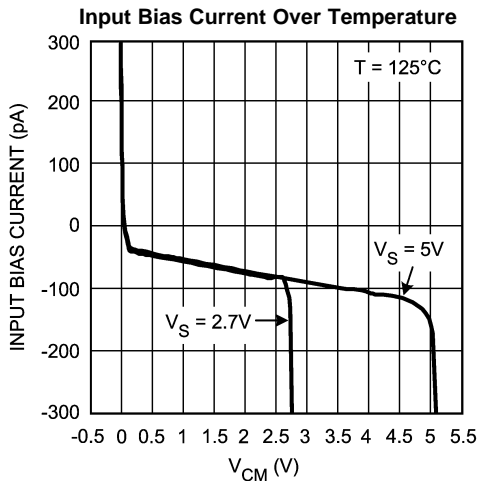

Figure 15.

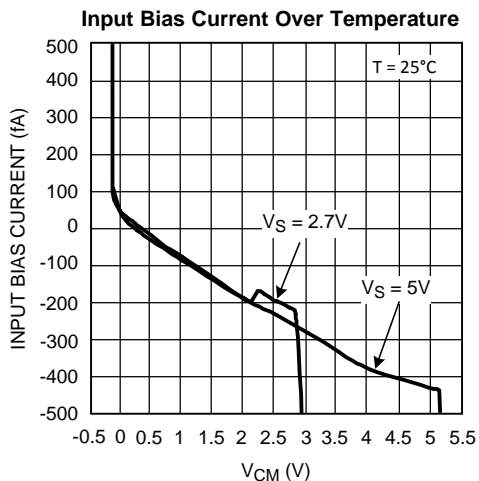

Figure 16.

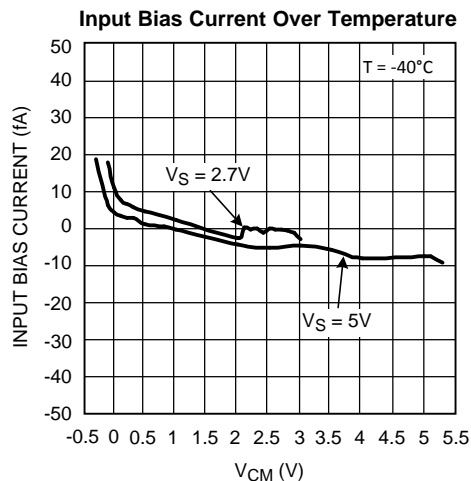

Figure 17.

**THD+N vs. Frequency**

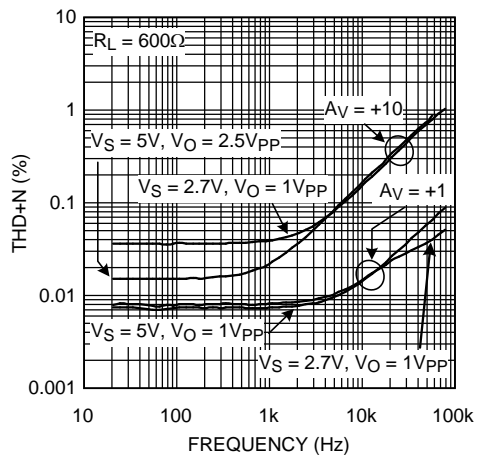

Figure 18.

**THD+N vs. VOUT**

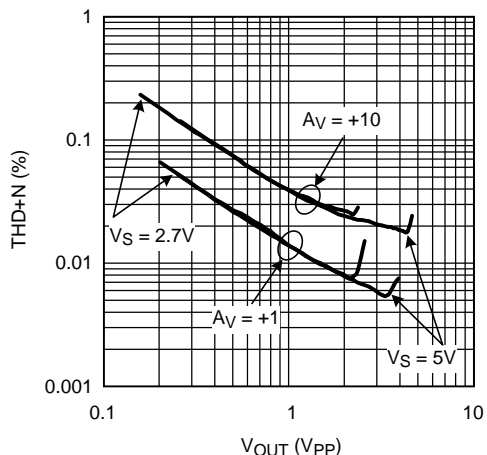

Figure 19.

Typical Performance Characteristics (continued)

Slew Rate vs. Supply Voltage

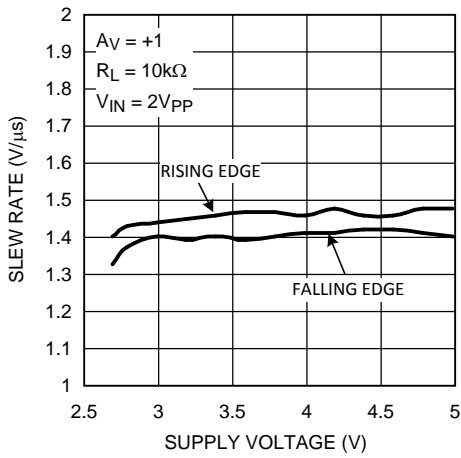

Figure 20.

Open Loop Frequency Response Over Temperature

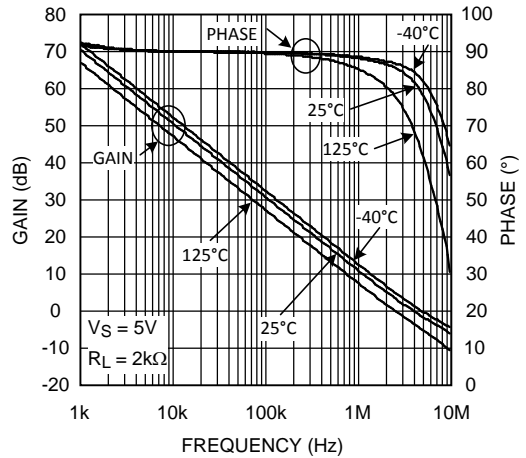

Figure 21.

Open Loop Frequency Response

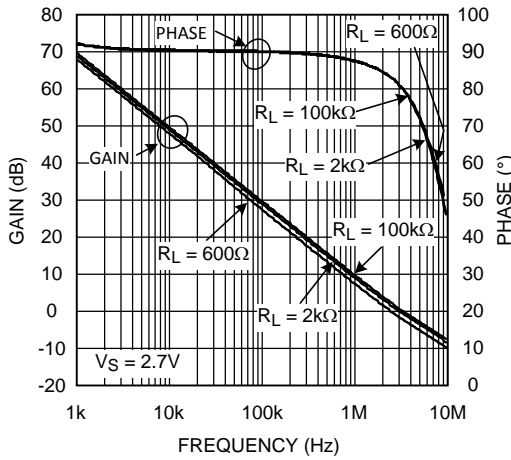

Figure 22.

Open Loop Frequency Response

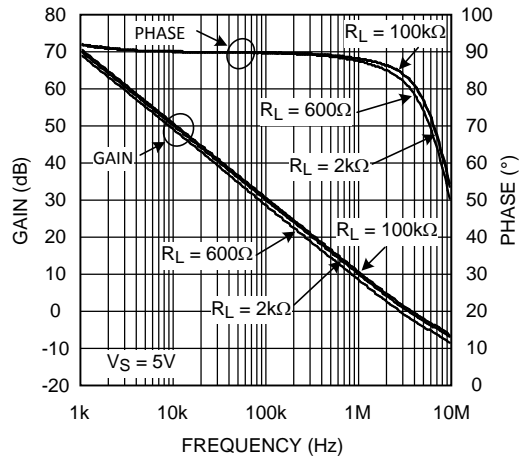

Figure 23.

Open Loop Gain & Phase with Cap. Loading

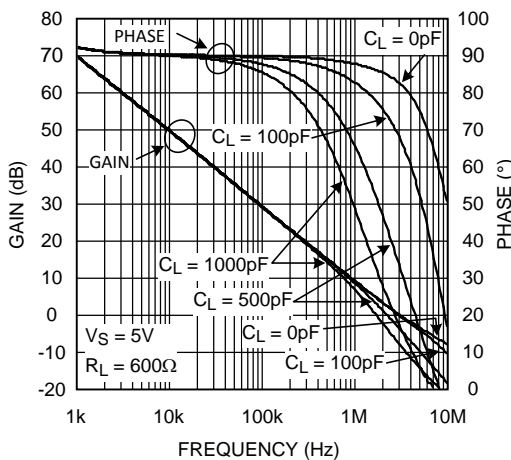

Figure 24.

Open Loop Gain & Phase with Cap. Loading

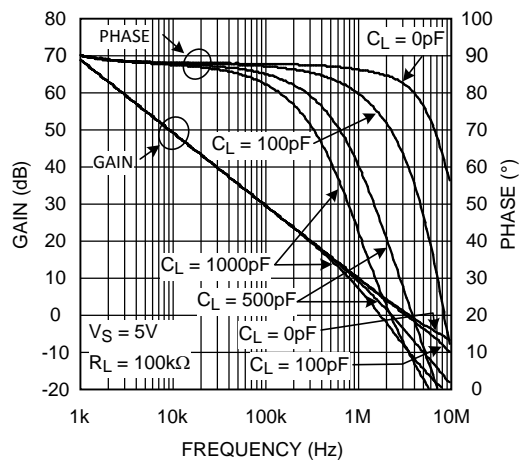

Figure 25.



Typical Performance Characteristics (continued)

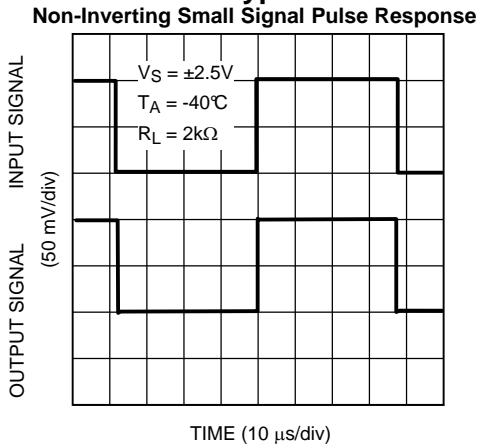

Figure 26.

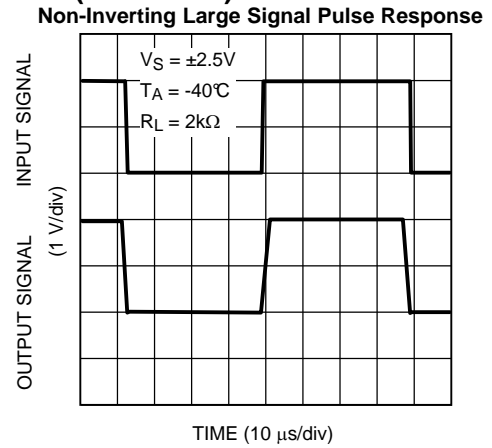

Figure 27.

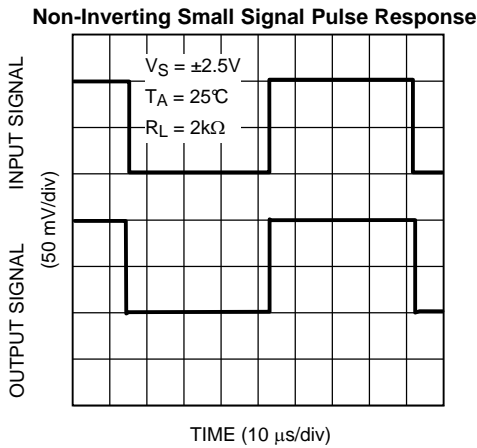

Figure 28.

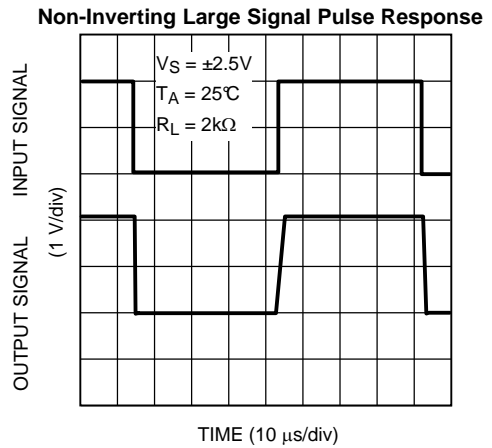

Figure 29.

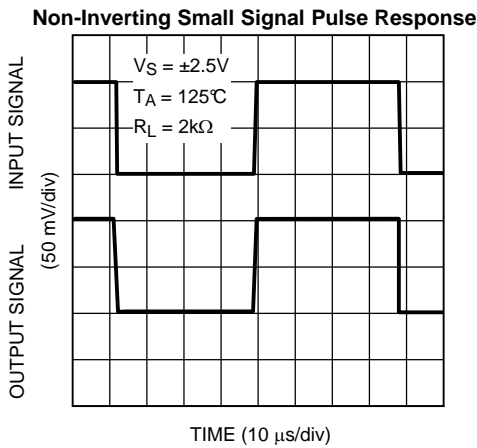

Figure 30.

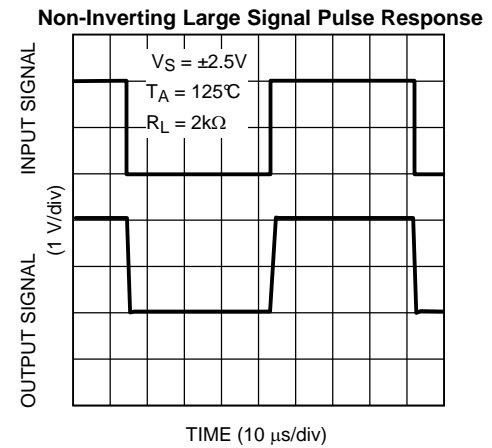
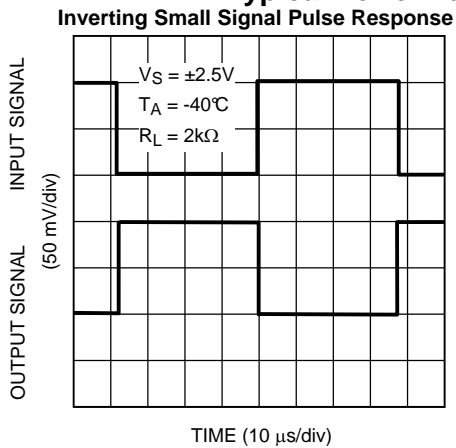
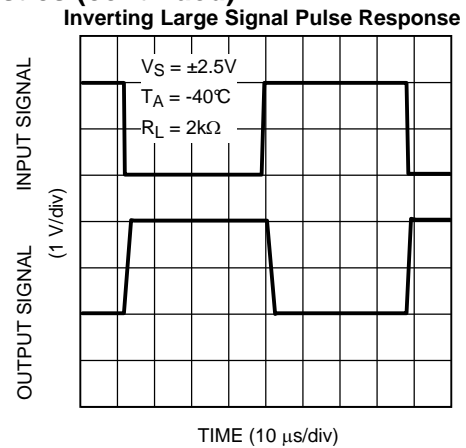

Figure 31.

**Typical Performance Characteristics (continued)**



**Figure 32.**



**Figure 33.**

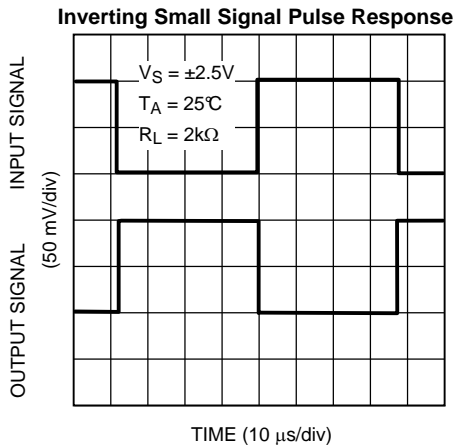

**Figure 34.**

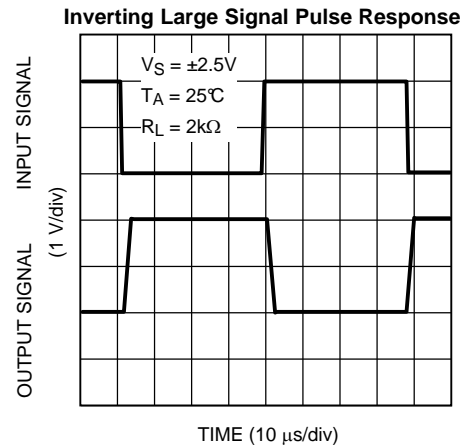

**Figure 35.**

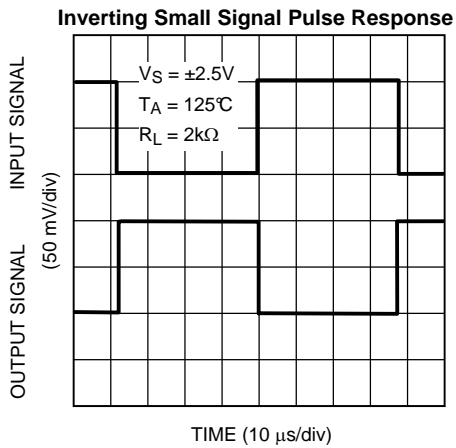

**Figure 36.**

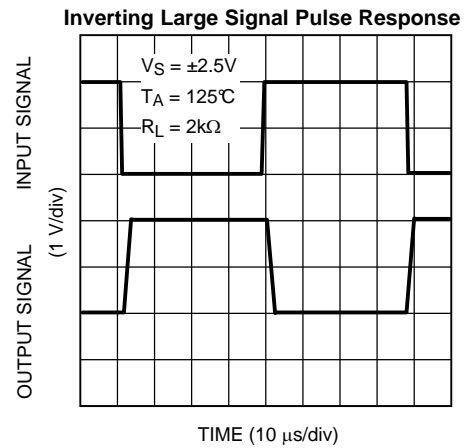

**Figure 37.**

Typical Performance Characteristics (continued)

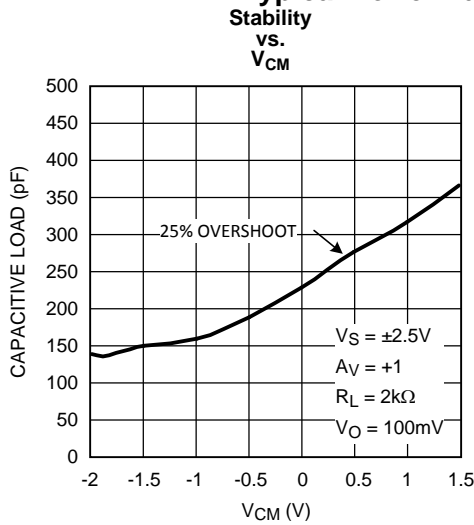

Figure 38.

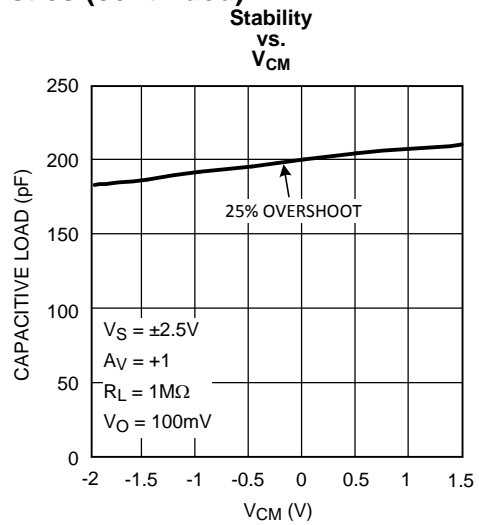

Figure 39.

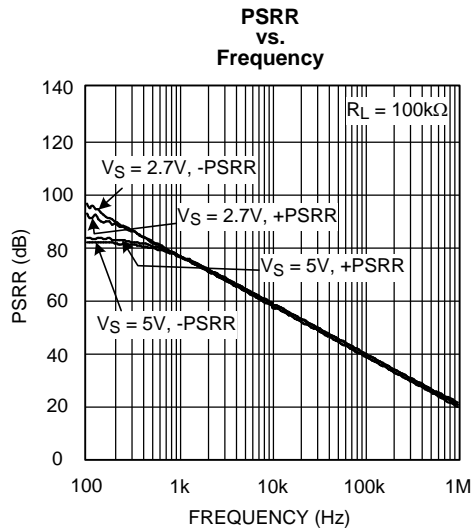

Figure 40.

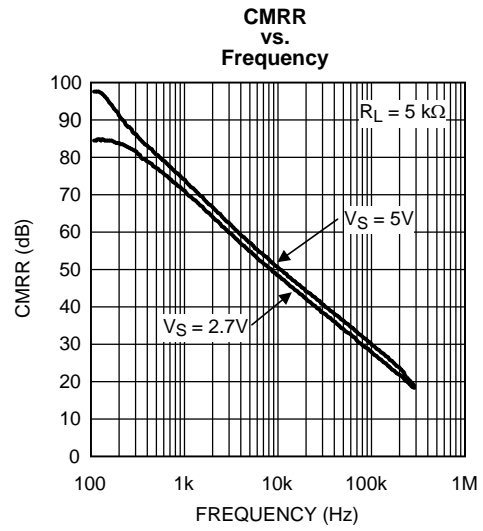

Figure 41.

## APPLICATION NOTE

### SM73308

The SM73308 is a precision amplifier with very low noise and ultra low offset voltage. SM73308's extended temperature range of  $-40^{\circ}\text{C}$  to  $125^{\circ}\text{C}$  enables the user to design a variety of applications including automotive.

The SM73308 has a maximum offset voltage of 1mV over the extended temperature range. This makes the SM73308 ideal for applications where precision is important.

### INSTRUMENTATION AMPLIFIER

Measurement of very small signals with an amplifier requires close attention to the input impedance of the amplifier, gain of the overall signal on the inputs, and the gain on each input since we are only interested in the difference of the two inputs and the common signal is considered noise. A classic solution is an instrumentation amplifier. Instrumentation amplifiers have a finite, accurate, and stable gain. Also they have extremely high input impedances and very low output impedances. Finally they have an extremely high CMRR so that the amplifier can only respond to the differential signal. A typical instrumentation amplifier is shown in [Figure 42](#).

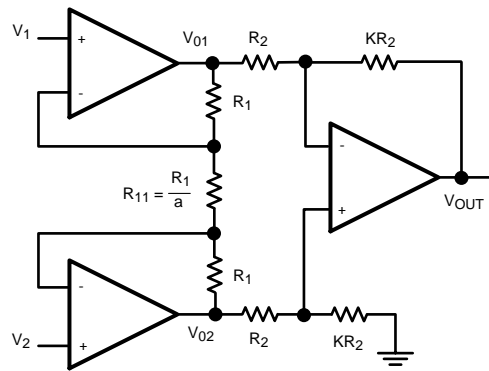

**Figure 42. Instrumentation Amplifier**

There are two stages in this amplifier. The last stage, output stage, is a differential amplifier. In an ideal case the two amplifiers of the first stage, input stage, would be set up as buffers to isolate the inputs. However they cannot be connected as followers because of real amplifier's mismatch. That is why there is a balancing resistor between the two. The product of the two stages of gain will give the gain of the instrumentation amplifier. Ideally, the CMRR should be infinite. However the output stage has a small non-zero common mode gain which results from resistor mismatch.

In the input stage of the circuit, current is the same across all resistors. This is due to the high input impedance and low input bias current of the SM73308. With the node equations we have:

$$\text{GIVEN: } I_{R_1} = I_{R_{11}} \quad (2)$$

By Ohm's Law:

$$\begin{aligned} V_{01} - V_{02} &= (2R_1 + R_{11}) I_{R_{11}} \\ &= (2a + 1) R_{11} \cdot I_{R_{11}} \\ &= (2a + 1) V_{R_{11}} \end{aligned} \quad (3)$$

However:

$$V_{R_{11}} = V_1 - V_2 \quad (4)$$

So we have:

$$V_{O1} - V_{O2} = (2a + 1) (V_1 - V_2) \tag{5}$$

Now looking at the output of the instrumentation amplifier:

$$\begin{aligned} V_O &= \frac{KR_2}{R_2} (V_{O2} - V_{O1}) \\ &= -K (V_{O1} - V_{O2}) \end{aligned} \tag{6}$$

Substituting from Equation 5:

$$V_O = -K (2a + 1) (V_1 - V_2) \tag{7}$$

This shows the gain of the instrumentation amplifier to be:

$$-K(2a+1) \tag{8}$$

Typical values for this circuit can be obtained by setting: a = 12 and K= 4. This results in an overall gain of -100.

Figure 43 shows typical CMRR characteristics of this Instrumentation amplifier over frequency. Three SM73308 amplifiers are used along with 1% resistors to minimize resistor mismatch. Resistors used to build the circuit are: R<sub>1</sub> = 21.6kΩ, R<sub>11</sub> = 1.8kΩ, R<sub>2</sub> = 2.5kΩ with K = 40 and a = 12. This results in an overall gain of -1000, -K(2a+1) = -1000.

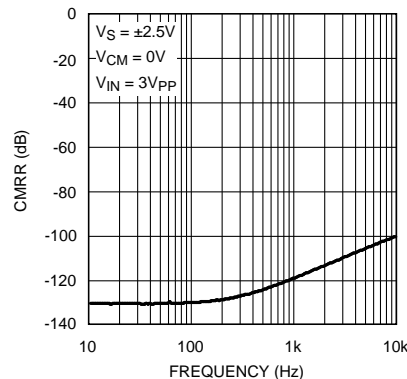

**Figure 43. CMRR vs. Frequency**

## ACTIVE FILTER

Active filters are circuits with amplifiers, resistors, and capacitors. The use of amplifiers instead of inductors, which are used in passive filters, enhances the circuit performance while reducing the size and complexity of the filter.

The simplest active filters are designed using an inverting op amp configuration where at least one reactive element has been added to the configuration. This means that the op amp will provide "frequency-dependent" amplification, since reactive elements are frequency dependent devices.

## LOW PASS FILTER

The following shows a very simple low pass filter.

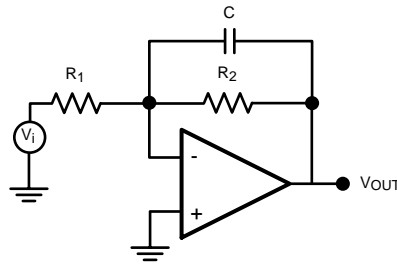

**Figure 44. Lowpass Filter**

The transfer function can be expressed as follows:

By KCL:

$$\frac{-V_i}{R_1} - \frac{V_O}{\left[ \frac{1}{j\omega C} \right]} - \frac{V_O}{R_2} = 0 \quad (9)$$

Simplifying this further results in:

$$V_O = \frac{-R_2}{R_1} \left[ \frac{1}{j\omega C R_2 + 1} \right] V_i \quad (10)$$

or

$$\frac{V_O}{V_i} = \frac{-R_2}{R_1} \left[ \frac{1}{j\omega C R_2 + 1} \right] \quad (11)$$

Now, substituting  $\omega = 2\pi f$ , so that the calculations are in f(Hz) and not  $\omega$ (rad/s), and setting the DC gain  $H_O = -R_2/R_1$  and  $H = V_O/V_i$

$$H = H_O \left[ \frac{1}{j2\pi f C R_2 + 1} \right] \quad (12)$$

Set:  $f_o = 1/(2\pi R_1 C)$

$$H = H_O \left[ \frac{1}{1 + j(f/f_o)} \right] \quad (13)$$

Low pass filters are known as lossy integrators because they only behave as an integrator at higher frequencies. Just by looking at the transfer function one can predict the general form of the bode plot. When the  $f/f_o$  ratio is small, the capacitor is in effect an open circuit and the amplifier behaves at a set DC gain. Starting at  $f_o$ , -3dB corner, the capacitor will have the dominant impedance and hence the circuit will behave as an integrator and the signal will be attenuated and eventually cut. The bode plot for this filter is shown in the following picture:

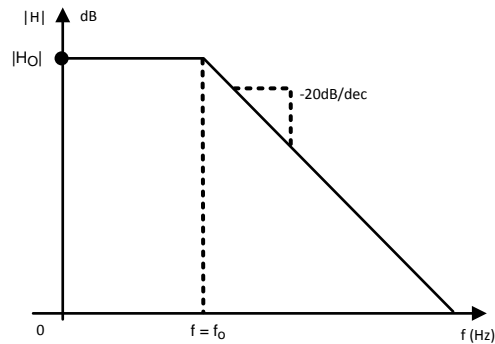

Figure 45. Lowpass Filter Transfer Function

## HIGH PASS FILTER

In a similar approach, one can derive the transfer function of a high pass filter. A typical first order high pass filter is shown below:

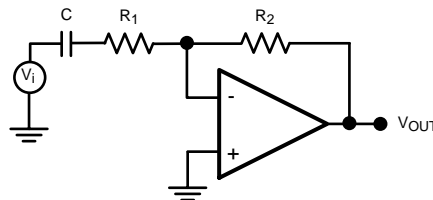

Figure 46. Highpass Filter

Writing the KCL for this circuit :

( $V_1$  denotes the voltage between C and  $R_1$ )

$$\frac{V_1 - V_i}{\frac{1}{j\omega C}} = \frac{V_1 - V^-}{R_1} \quad (14)$$

$$\frac{V^- + V_1}{R_1} = \frac{V^- + V_O}{R_2} \quad (15)$$

Solving these two equations to find the transfer function and using:

$$f_0 = \frac{1}{2\pi R_1 C} \quad (16)$$

(high frequency gain)  $H_0 = \frac{-R_2}{R_1}$  and  $H = \frac{V_O}{V_i}$

Which results:

$$H = H_0 \frac{j(f/f_0)}{1 + j(f/f_0)} \quad (17)$$

Looking at the transfer function, it is clear that when  $f/f_0$  is small, the capacitor is open and hence no signal is getting in to the amplifier. As the frequency increases the amplifier starts operating. At  $f = f_0$  the capacitor behaves like a short circuit and the amplifier will have a constant, high frequency, gain of  $H_0$ . Figure 47 shows the transfer function of this high pass filter:

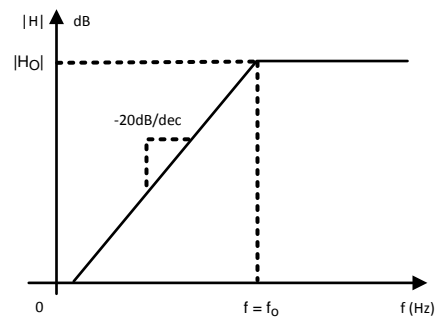

**Figure 47. Highpass Filter Transfer Function**

## BAND PASS FILTER

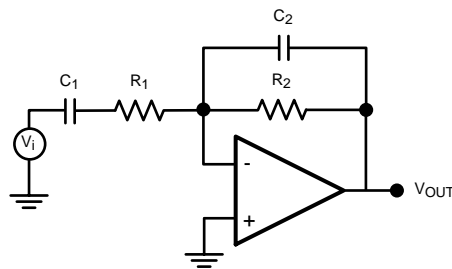

**Figure 48. Bandpass Filter**

Combining a low pass filter and a high pass filter will generate a band pass filter. In this network the input impedance forms the high pass filter while the feedback impedance forms the low pass filter. Choosing the corner frequencies so that  $f_1 < f_2$ , then all the frequencies in between,  $f_1 \leq f \leq f_2$ , will pass through the filter while frequencies below  $f_1$  and above  $f_2$  will be cut off.

The transfer function can be easily calculated using the same methodology as before.

$$H = H_0 \frac{j(f/f_1)}{[1 + j(f/f_1)] [1 + j(f/f_2)]}$$

where

$$f_1 = \frac{1}{2\pi R_1 C_1}$$

$$f_2 = \frac{1}{2\pi R_2 C_2}$$

$$H_0 = \frac{-R_2}{R_1}$$

(18)

The transfer function is presented in the following figure.



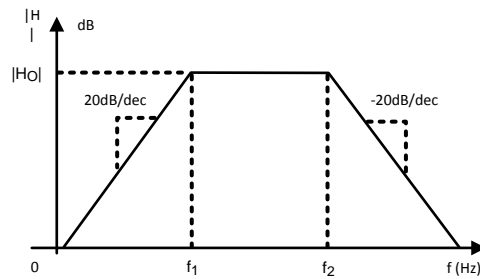

Figure 49. Bandpass filter Transfer Function

### STATE VARIABLE ACTIVE FILTER

State variable active filters are circuits that can simultaneously represent high pass, band pass, and low pass filters. The state variable active filter uses three separate amplifiers to achieve this task. A typical state variable active filter is shown in Figure 50. The first amplifier in the circuit is connected as a gain stage. The second and third amplifiers are connected as integrators, which means they behave as low pass filters. The feedback path from the output of the third amplifier to the first amplifier enables this low frequency signal to be fed back with a finite and fairly low closed loop gain. This is while the high frequency signal on the input is still gained up by the open loop gain of the 1st amplifier. This makes the first amplifier a high pass filter. The high pass signal is then fed into a low pass filter. The outcome is a band pass signal, meaning the second amplifier is a band pass filter. This signal is then fed into the third amplifiers input and so, the third amplifier behaves as a simple low pass filter.

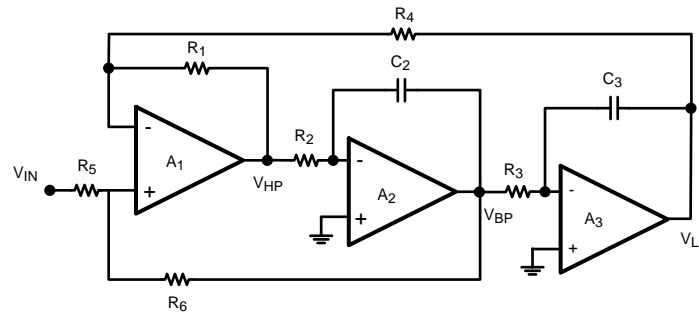
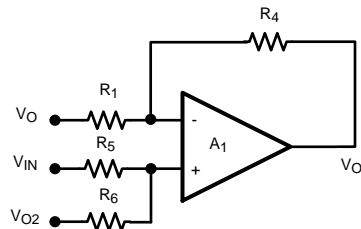
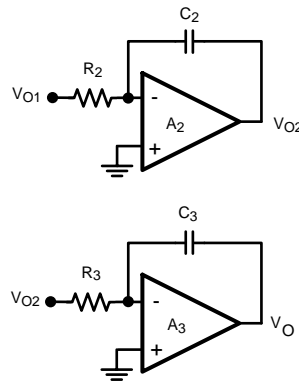

Figure 50. State Variable Active Filter

The transfer function of each filter needs to be calculated. The derivations will be more trivial if each stage of the filter is shown on its own.

The three components are:





For  $A_1$  the relationship between input and output is:

$$V_{O1} = \frac{-R_4}{R_1} V_0 + \left[ \frac{R_6}{R_5 + R_6} \right] \left[ \frac{R_1 + R_4}{R_1} \right] V_{IN} + \left[ \frac{R_5}{R_5 + R_6} \right] \left[ \frac{R_1 + R_4}{R_1} \right] V_{O2} \quad (19)$$

This relationship depends on the output of all the filters. The input-output relationship for  $A_2$  can be expressed as:

$$V_{O2} = \frac{-1}{s C_2 R_2} V_{O1} \quad (20)$$

And finally this relationship for  $A_3$  is as follows:

$$V_0 = \frac{-1}{s C_3 R_3} V_{O2} \quad (21)$$

Re-arranging these equations, one can find the relationship between  $V_0$  and  $V_{IN}$  (transfer function of the lowpass filter),  $V_{O1}$  and  $V_{IN}$  (transfer function of the highpass filter), and  $V_{O2}$  and  $V_{IN}$  (transfer function of the bandpass filter) These relationships are as follows:

### Lowpass Filter

$$\frac{V_0}{V_{IN}} = \frac{\left[ \frac{R_1 + R_4}{R_1} \right] \left[ \frac{R_6}{R_5 + R_6} \right] \left[ \frac{1}{C_2 C_3 R_2 R_3} \right]}{s^2 + s \left[ \frac{1}{C_2 R_2} \right] \left[ \frac{R_5}{R_5 + R_6} \right] \left[ \frac{R_1 + R_4}{R_1} \right] + \left[ \frac{1}{C_2 C_3 R_2 R_3} \right]} \quad (22)$$

### Highpass Filter

$$\frac{V_{O1}}{V_{IN}} = \frac{s^2 \left[ \frac{R_1 + R_4}{R_1} \right] \left[ \frac{R_6}{R_5 + R_6} \right]}{s^2 + s \left[ \frac{1}{C_2 R_2} \right] \left[ \frac{R_5}{R_5 + R_6} \right] \left[ \frac{R_1 + R_4}{R_1} \right] + \left[ \frac{1}{C_2 C_3 R_2 R_3} \right]} \quad (23)$$

### Bandpass Filter

$$\frac{V_{O2}}{V_{IN}} = \frac{s \left[ \frac{1}{C_2 R_2} \right] \left[ \frac{R_1 + R_4}{R_1} \right] \left[ \frac{R_6}{R_5 + R_6} \right]}{s^2 + s \left[ \frac{1}{C_2 R_2} \right] \left[ \frac{R_5}{R_5 + R_6} \right] \left[ \frac{R_1 + R_4}{R_1} \right] + \left[ \frac{1}{C_2 C_3 R_2 R_3} \right]} \quad (24)$$

The center frequency and Quality Factor for all of these filters is the same. The values can be calculated in the following manner:

$$\omega_c = \sqrt{\frac{1}{C_2 C_3 R_2 R_3}}$$

and

$$Q = \sqrt{\frac{C_2 R_2}{C_3 R_3} \left[ \frac{R_5 + R_6}{R_6} \right] \left[ \frac{R_1}{R_1 + R_4} \right]} \quad (25)$$

A design example is shown here:

Designing a bandpass filter with center frequency of 10kHz and Quality Factor of 5.5

To do this, first consider the Quality Factor. It is best to pick convenient values for the capacitors.  $C_2 = C_3 = 1000\text{pF}$ . Also, choose  $R_1 = R_4 = 30\text{k}\Omega$ . Now values of  $R_5$  and  $R_6$  need to be calculated. With the chosen values for the capacitors and resistors,  $Q$  reduces to:

$$Q = \frac{11}{2} = \frac{1}{2} \left[ \frac{R_5 + R_6}{R_6} \right] \quad (26)$$

or

$$R_5 = 10R_6 \quad R_6 = 1.5\text{k}\Omega \quad R_5 = 15\text{k}\Omega \quad (27)$$

Also, for  $f = 10\text{kHz}$ , the center frequency is  $\omega_c = 2\pi f = 62.8\text{kHz}$ .

Using the expressions above, the appropriate resistor values will be  $R_2 = R_3 = 16\text{k}\Omega$ .

The following graphs show the transfer function of each of the filters. The DC gain of this circuit is:

$$\text{DC GAIN} = \left[ \frac{R_1 + R_4}{R_1} \right] \left[ \frac{R_6}{R_5 + R_6} \right] = -14.8 \text{ dB} \quad (28)$$

## REVISION HISTORY

Changes from Revision A (April 2013) to Revision B	Page
• Changed layout of National Data Sheet to TI format .....	<a href="#">19</a>

**PACKAGING INFORMATION**

Orderable Device	Status (1)	Package Type	Package Drawing	Pins	Package Qty	Eco Plan (2)	Lead finish/ Ball material (6)	MSL Peak Temp (3)	Op Temp (°C)	Device Marking (4/5)	Samples
SM73308MG/NOPB	ACTIVE	SC70	DCK	5	1000	RoHS & Green	SN	Level-1-260C-UNLIM	-40 to 125	S08	<a href="#">Samples</a>
SM73308MGE/NOPB	ACTIVE	SC70	DCK	5	250	RoHS & Green	SN	Level-1-260C-UNLIM	-40 to 125	S08	<a href="#">Samples</a>
SM73308MGX/NOPB	ACTIVE	SC70	DCK	5	3000	RoHS & Green	SN	Level-1-260C-UNLIM	-40 to 125	S08	<a href="#">Samples</a>

(1) The marketing status values are defined as follows:

**ACTIVE:** Product device recommended for new designs.

**LIFEBUY:** TI has announced that the device will be discontinued, and a lifetime-buy period is in effect.

**NRND:** Not recommended for new designs. Device is in production to support existing customers, but TI does not recommend using this part in a new design.

**PREVIEW:** Device has been announced but is not in production. Samples may or may not be available.

**OBSOLETE:** TI has discontinued the production of the device.

(2) **RoHS:** TI defines "RoHS" to mean semiconductor products that are compliant with the current EU RoHS requirements for all 10 RoHS substances, including the requirement that RoHS substance do not exceed 0.1% by weight in homogeneous materials. Where designed to be soldered at high temperatures, "RoHS" products are suitable for use in specified lead-free processes. TI may reference these types of products as "Pb-Free".

**RoHS Exempt:** TI defines "RoHS Exempt" to mean products that contain lead but are compliant with EU RoHS pursuant to a specific EU RoHS exemption.

**Green:** TI defines "Green" to mean the content of Chlorine (Cl) and Bromine (Br) based flame retardants meet JS709B low halogen requirements of <=1000ppm threshold. Antimony trioxide based flame retardants must also meet the <=1000ppm threshold requirement.

(3) MSL, Peak Temp. - The Moisture Sensitivity Level rating according to the JEDEC industry standard classifications, and peak solder temperature.

(4) There may be additional marking, which relates to the logo, the lot trace code information, or the environmental category on the device.

(5) Multiple Device Markings will be inside parentheses. Only one Device Marking contained in parentheses and separated by a "~" will appear on a device. If a line is indented then it is a continuation of the previous line and the two combined represent the entire Device Marking for that device.

(6) Lead finish/Ball material - Orderable Devices may have multiple material finish options. Finish options are separated by a vertical ruled line. Lead finish/Ball material values may wrap to two lines if the finish value exceeds the maximum column width.

**Important Information and Disclaimer:** The information provided on this page represents TI's knowledge and belief as of the date that it is provided. TI bases its knowledge and belief on information provided by third parties, and makes no representation or warranty as to the accuracy of such information. Efforts are underway to better integrate information from third parties. TI has taken and continues to take reasonable steps to provide representative and accurate information but may not have conducted destructive testing or chemical analysis on incoming materials and chemicals. TI and TI suppliers consider certain information to be proprietary, and thus CAS numbers and other limited information may not be available for release.

In no event shall TI's liability arising out of such information exceed the total purchase price of the TI part(s) at issue in this document sold by TI to Customer on an annual basis.

**TAPE AND REEL INFORMATION**

**QUADRANT ASSIGNMENTS FOR PIN 1 ORIENTATION IN TAPE**

\*All dimensions are nominal

Device	Package Type	Package Drawing	Pins	SPQ	Reel Diameter (mm)	Reel Width W1 (mm)	A0 (mm)	B0 (mm)	K0 (mm)	P1 (mm)	W (mm)	Pin1 Quadrant
SM73308MG/NOPB	SC70	DCK	5	1000	178.0	8.4	2.25	2.45	1.2	4.0	8.0	Q3
SM73308MGE/NOPB	SC70	DCK	5	250	178.0	8.4	2.25	2.45	1.2	4.0	8.0	Q3
SM73308MGX/NOPB	SC70	DCK	5	3000	178.0	8.4	2.25	2.45	1.2	4.0	8.0	Q3

**TAPE AND REEL BOX DIMENSIONS**

\*All dimensions are nominal

Device	Package Type	Package Drawing	Pins	SPQ	Length (mm)	Width (mm)	Height (mm)
SM73308MG/NOPB	SC70	DCK	5	1000	208.0	191.0	35.0
SM73308MGE/NOPB	SC70	DCK	5	250	208.0	191.0	35.0
SM73308MGX/NOPB	SC70	DCK	5	3000	208.0	191.0	35.0



DCK0005A



# PACKAGE OUTLINE

SOT - 1.1 max height

SMALL OUTLINE TRANSISTOR

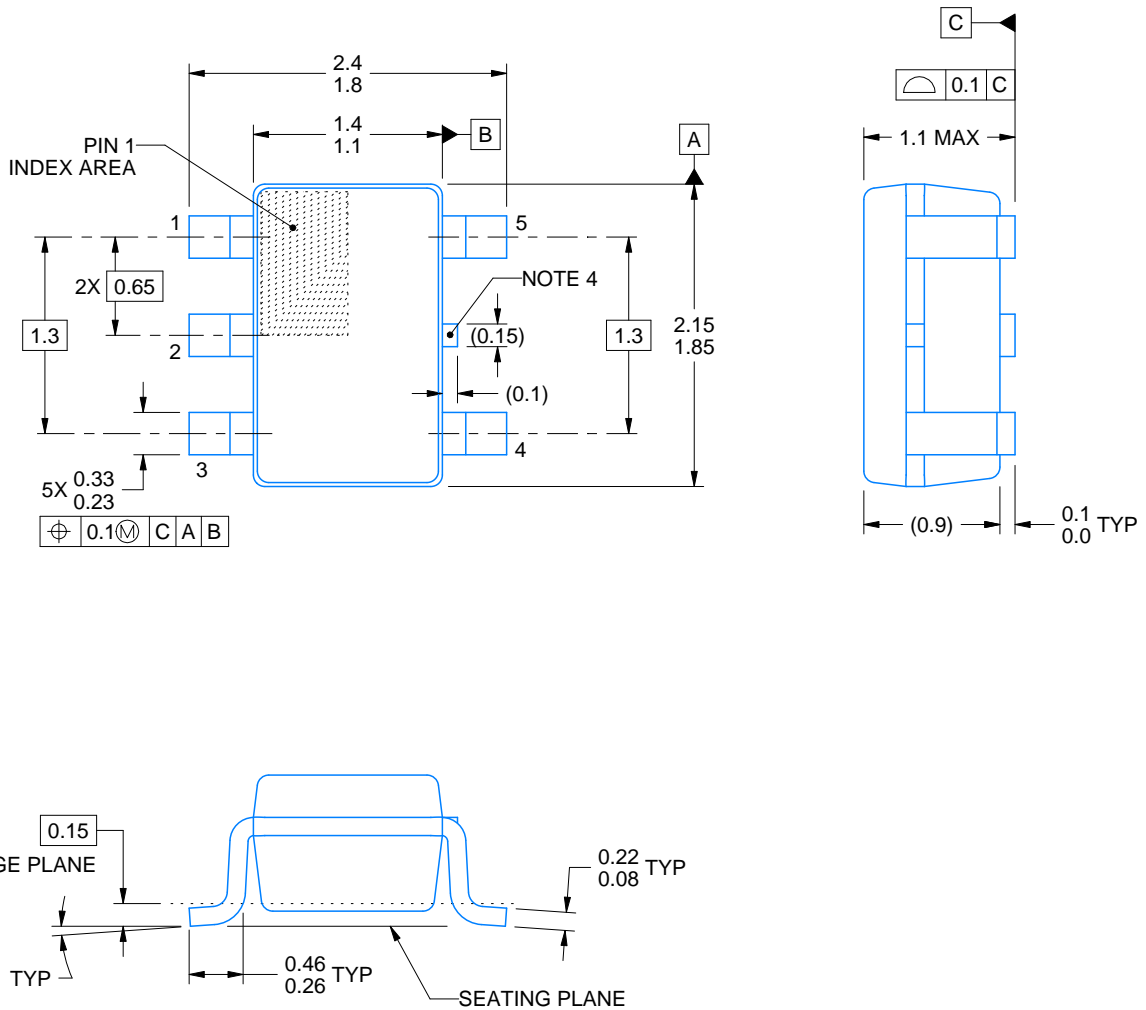

4214834/C 03/2023

NOTES:

1. All linear dimensions are in millimeters. Any dimensions in parenthesis are for reference only. Dimensioning and tolerancing per ASME Y14.5M.
2. This drawing is subject to change without notice.
3. Reference JEDEC MO-203.
4. Support pin may differ or may not be present.

# EXAMPLE BOARD LAYOUT

DCK0005A

SOT - 1.1 max height

SMALL OUTLINE TRANSISTOR

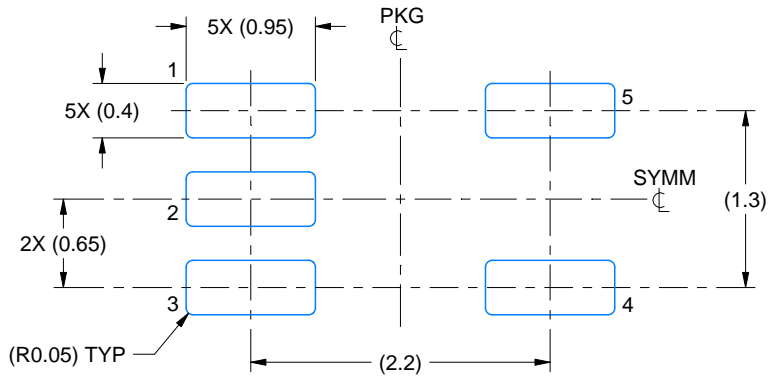

LAND PATTERN EXAMPLE  
EXPOSED METAL SHOWN  
SCALE:18X

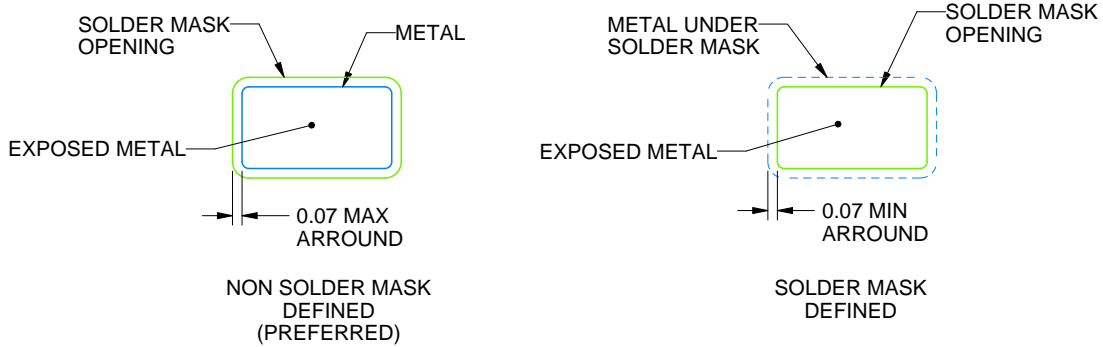

SOLDER MASK DETAILS

4214834/C 03/2023

NOTES: (continued)

- 4. Publication IPC-7351 may have alternate designs.
- 5. Solder mask tolerances between and around signal pads can vary based on board fabrication site.

# EXAMPLE STENCIL DESIGN

DCK0005A

SOT - 1.1 max height

SMALL OUTLINE TRANSISTOR



SOLDER PASTE EXAMPLE  
BASED ON 0.125 THICK STENCIL  
SCALE:18X

4214834/C 03/2023

NOTES: (continued)

6. Laser cutting apertures with trapezoidal walls and rounded corners may offer better paste release. IPC-7525 may have alternate design recommendations.
7. Board assembly site may have different recommendations for stencil design.

## IMPORTANT NOTICE AND DISCLAIMER

TI PROVIDES TECHNICAL AND RELIABILITY DATA (INCLUDING DATA SHEETS), DESIGN RESOURCES (INCLUDING REFERENCE DESIGNS), APPLICATION OR OTHER DESIGN ADVICE, WEB TOOLS, SAFETY INFORMATION, AND OTHER RESOURCES "AS IS" AND WITH ALL FAULTS, AND DISCLAIMS ALL WARRANTIES, EXPRESS AND IMPLIED, INCLUDING WITHOUT LIMITATION ANY IMPLIED WARRANTIES OF MERCHANTABILITY, FITNESS FOR A PARTICULAR PURPOSE OR NON-INFRINGEMENT OF THIRD PARTY INTELLECTUAL PROPERTY RIGHTS.

These resources are intended for skilled developers designing with TI products. You are solely responsible for (1) selecting the appropriate TI products for your application, (2) designing, validating and testing your application, and (3) ensuring your application meets applicable standards, and any other safety, security, regulatory or other requirements.

These resources are subject to change without notice. TI grants you permission to use these resources only for development of an application that uses the TI products described in the resource. Other reproduction and display of these resources is prohibited. No license is granted to any other TI intellectual property right or to any third party intellectual property right. TI disclaims responsibility for, and you will fully indemnify TI and its representatives against, any claims, damages, costs, losses, and liabilities arising out of your use of these resources.

TI's products are provided subject to [TI's Terms of Sale](#) or other applicable terms available either on [ti.com](https://www.ti.com) or provided in conjunction with such TI products. TI's provision of these resources does not expand or otherwise alter TI's applicable warranties or warranty disclaimers for TI products.

TI objects to and rejects any additional or different terms you may have proposed.

Mailing Address: Texas Instruments, Post Office Box 655303, Dallas, Texas 75265  
Copyright © 2023, Texas Instruments Incorporated