



Quality Products. Service Excellence.

Printer and Paper Stand *S2CPS Series*



- Provides convenient pullout access and support for printers in bases.
- Two versions available for high or low applications.
- Mounts onto Combination Rails (not included).
- Finished in textured black.
- Slides included.

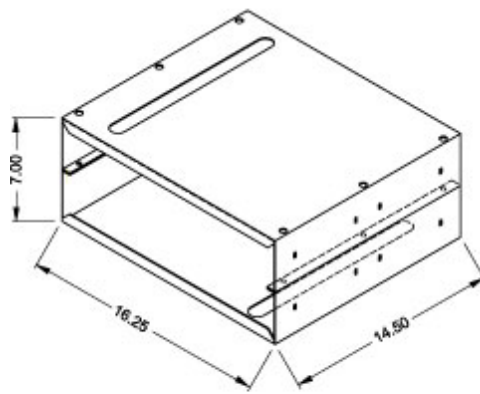

Low Printer Stand

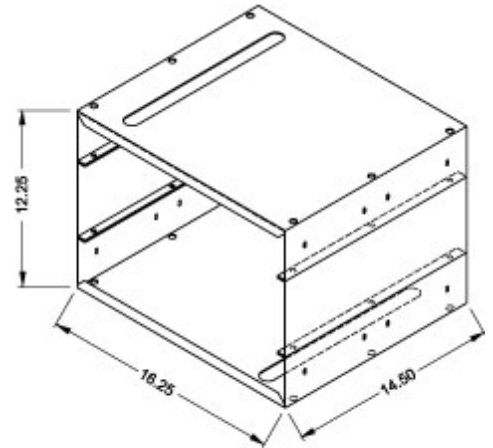

High Printer Stand

Part No.	Description	Height
2CLPS	Low Printer Stand	7.00
2CHPS	High Printer Stand	12.25

Data subject to change without notice

© 2023. Hammond Manufacturing Ltd. All rights reserved.