

Rotary Position Sensor

PHS04 Series



OBSOLETE

Features:

- Angle/Position sensor with more than a 300,000 life cycle
- Small footprint size at 4mm width x 5mm length
- Smooth operation

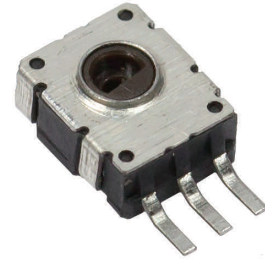

Description:

The PHS04 series is a rotary position sensor that features a small footprint, smooth operation, and a 300,000 life cycle. Some applications are game controllers and robot joint angle controls.

Applications:

- Robot joint angle control
- Game controller

Electrical Specifications

Electrical Characteristics (T_A = 25° C unless otherwise noted)

SYMBOL	PARAMETER	MIN	TYP	MAX	UNITS	TEST CONDITIONS
Ω	Total Resistance	1K		100K	Ohms	
V	Rated Voltage	5.0		50	Volts	
W	Rated Power		0.01		Watts	
	Linearity Tolerance			±5%		
	Resistance Tolerance		20%			
	Sliding Noise			300	mV	
	Withstand Voltage		1		Min	At AC 250V
	Insulated Resistance	100			mΩ	DC250V, 1 minute

General Note

TT Electronics reserves the right to make changes in product specification without notice or liability. All information is subject to TT Electronics' own data and is considered accurate at time of going to print.

Rotary Position Sensor

PHS04 Series

OBSOLETE



Mechanical Characteristics	
Rotational torque	20mN-m
Total rotational angle	360°
Push strength	30 N, 3 sec
Pull strength	5 N, 3 sec
Operating temperature	-20°C to 70°C
Storage temperature	-30°C to 70°C
Operating life	300,000 (Standard) 500,000 (Long life)
Dry Heat	70±2°C, 240±2hr, -30%≤ΔTR≤+5%
Cold	-30±2°C, 300±5hr, without load, ΔTR≤±20%
Damp Heat	70±2°C, 85%RH, 300±5hr, -5%≤ΔTR≤+35%
Temperature Cycle	-10~+70°C, 5 cycles, ΔTR≤±10%
Temperature Characteristics	70±3°Cn 5hr, -20%≤ΔTR≤+5%
Soldering Conditions	Wave soldering: 250±5°C Peak, 3 sec max Manual soldering: 300°C Peak, 3 sec. max

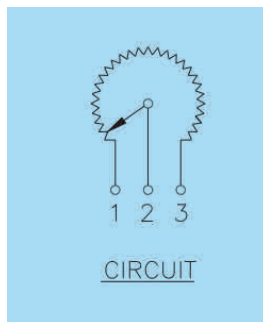
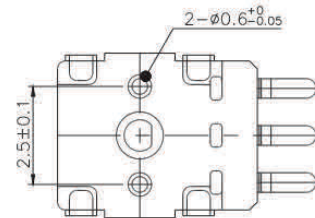
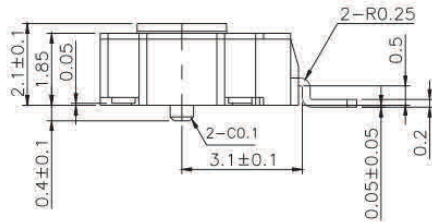
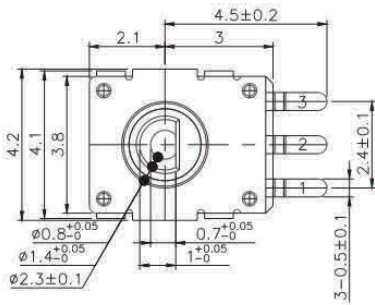

General Note

TT Electronics reserves the right to make changes in product specification without notice or liability. All information is subject to TT Electronics' own data and is considered accurate at time of going to print.

Rotary Position Sensor

PHS04 Series

OBSOLETE



Ordering Information

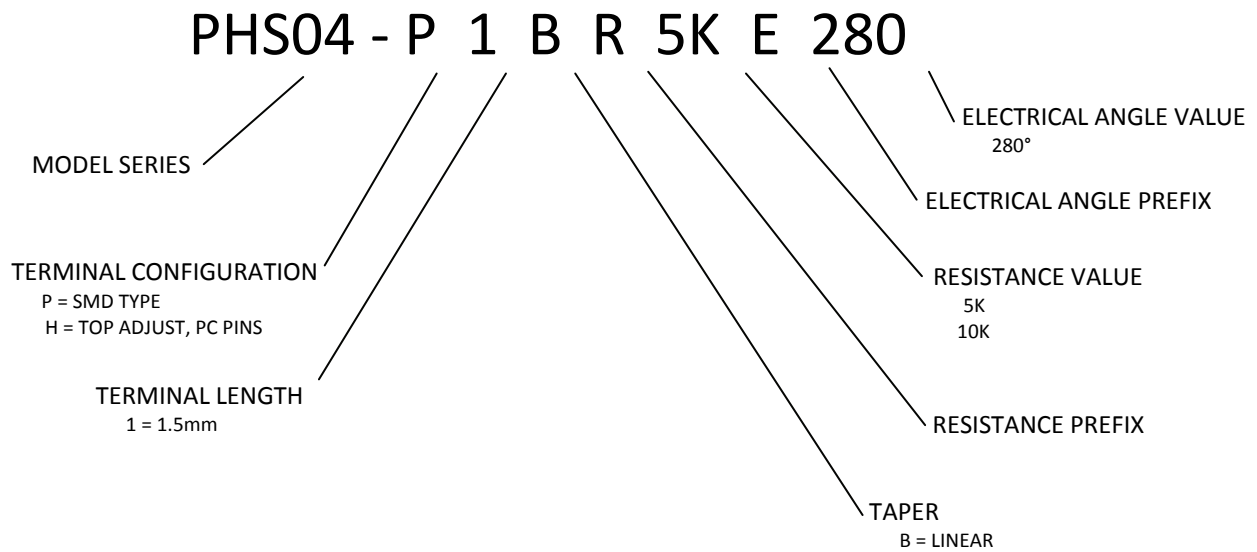

General Note
TT Electronics reserves the right to make changes in product specification without notice or liability. All information is subject to TT Electronics' own data and is considered accurate at time of going to print.

© TT electronics plc Form # 500-1080-002 Rev - 06/2019

TT Electronics | BI Technologies
413 Rood RD, Suite 7
Calexico, CA 92231
Ph: + 1 (714) 447-2345
www.ttelectronics.com/bi-technologies
Rev C 07/2019 Page 3

Rotary Position Sensor

PHS04 Series

OBSOLETE



Packaging Specification

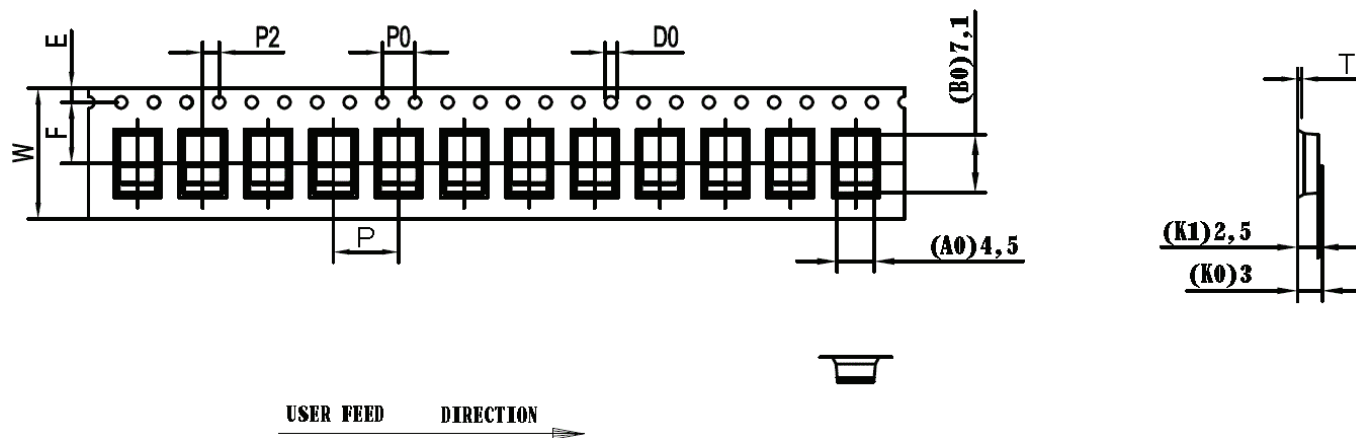

Notes:

- (1) The accumulated error of any 10 ratchet holes is below $\pm 0.20\text{mm}$;
- (2) Measurement of thickness of material must be conducted by the edge of the carrier belt
- (3) The non-parallelism of the distance of 100mm in the longitudinal of the carrier tape shall not exceed 1mm; anything exceeding 250mm does not calculate accumulated error.
- (4) Unspecified tolerance range within $\pm 0.1\text{mm}$;
- (5) A0, B0 measurement must be conducted at 0.3mm above the inner bottom of cavity, KO is internal depth.
- (6) Chamfer R of any unmarked cavity is 0.2-0.3
- (7) Unmarked demolding slope is 5°

ITEM	W	A0	B0	K0	K1	P	F	E	D	P0	P2	T	13"	
DIM	16.0	4.50	7.10	3.0	3.00	8.00	7.50	1.75	1.50	4.00	2.00	0.35	Length/ reel	Units/ reel
TOLE	+0.30 -0.30	+0.10 -0.10	+0.10 -0.10	+0.10 -0.10	+0.10 -0.10	+0.10 -0.10	+0.10 -0.10	+0.10 -0.10	+0.10 -0.10	+0.10 -0.10	+0.15 -0.15	+0.05 -0.05	23.04M	2800pcs

General Note

TT Electronics reserves the right to make changes in product specification without notice or liability. All information is subject to TT Electronics' own data and is considered accurate at time of going to print.