

Self-Protected Low Side Driver with In-Rush Current Management



ON Semiconductor®

www.onsemi.com

NCV8415

The NCV8415 is a three terminal protected Low-Side Smart Discrete FET. The protection features include Delta Thermal Shutdown, overcurrent, overtemperature, ESD and integrated Drain-to-Gate clamping for overvoltage protection. The device also offers fault indication via the gate pin. This device is suitable for harsh automotive environments.

Features

- Short-Circuit Protection with In-Rush Current Management
- Delta Thermal Shutdown
- Thermal Shutdown with Automatic Restart
- Overvoltage Protection
- Integrated Clamp for Overvoltage Protection and Inductive Switching
- ESD Protection
- dV/dt Robustness
- Analog Drive Capability (Logic Level Input)
- NCV Prefix for Automotive and Other Applications Requiring Unique Site and Control Change Requirements; AEC-Q101 Grade 1 Qualified and PPAP Capable
- These Devices are Pb-Free and are RoHS Compliant

Typical Applications

- Switch a Variety of Resistive, Inductive and Capacitive Loads
- Can Replace Electromechanical Relays and Discrete Circuits
- Automotive / Industrial

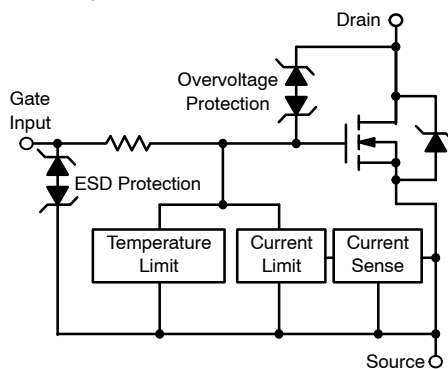
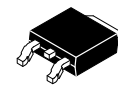

Figure 1. Block Diagram

V _{DSS} (Clamped)	R _{DS(ON)} TYP	I _D MAX (Limited)
42 V	80 mΩ @ 10 V	11 A



SOT-223
CASE 318E
STYLE 3



DPAK
CASE 369C
STYLE 2

MARKING DIAGRAMS

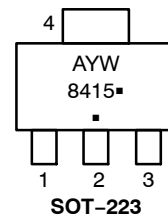

SOT-223

Pin Marking Information

- 1 = Gate
- 2 = Drain
- 3 = Source
- 4 = Drain

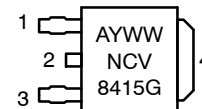

DPAK

- A = Assembly Location
- Y = Year
- W, WW = Work Week
- G or ■ = Pb-Free Package

(Note: Microdot may be in either location)

ORDERING INFORMATION

Device	Package	Shipping†
NCV8415DTRKG	DPAK (Pb-Free)	2500 / Tape & Reel
NCV8415STT1G	SOT-223 (Pb-Free)	1000 / Tape & Reel
NCV8415STT3G	SOT-223 (Pb-Free)	4000 / Tape & Reel

†For information on tape and reel specifications, including part orientation and tape sizes, please refer to our Tape and Reel Packaging Specification Brochure, BRD8011/D.

MAXIMUM RATINGS

Rating	Symbol	Value	Unit
Drain-to-Source Voltage Internally Clamped	V_{DSS}	42	V
Drain-to-Gate Voltage Internally Clamped	V_{DG}	42	V
Gate-to-Source Voltage	V_{GS}	± 14	V
Drain Current - Continuous	I_D	Internally Limited	
Total Power Dissipation (SOT-223) @ $T_A = 25^\circ\text{C}$ (Note 1) @ $T_A = 25^\circ\text{C}$ (Note 2)	P_D	1.29	W
		2.20	
Total Power Dissipation (DPAK) @ $T_A = 25^\circ\text{C}$ (Note 1) @ $T_A = 25^\circ\text{C}$ (Note 2)		1.54	
		2.99	
Thermal Resistance (SOT-223) Junction-to-Ambient (Note 1) Junction-to-Ambient (Note 2) Junction-to-Case (Soldering Point)	$R_{\theta JA}$ $R_{\theta JA}$ $R_{\theta JS}$	96.4 56.8 10.6	$^\circ\text{C/W}$
Thermal Resistance (DPAK) Junction-to-Ambient (Note 1) Junction-to-Ambient (Note 2) Junction-to-Case (Soldering Point)	$R_{\theta JA}$ $R_{\theta JA}$ $R_{\theta JS}$	80.8 41.8 3.2	
Single Pulse Inductive Load Switching Energy ($L = 10\text{ mH}$, $I_{Lpeak} = 4.2\text{ A}$, $V_{GS} = 5\text{ V}$, $R_G = 25\ \Omega$, $T_{Jstart} = 25^\circ\text{C}$)	E_{AS}	88	mJ
Load Dump Voltage ($V_{GS} = 0$ and 10 V , $R_L = 10\ \Omega$) (Note 3)	U_S^*	52	V
Operating Junction Temperature	T_J	-40 to 150	$^\circ\text{C}$
Storage Temperature	$T_{storage}$	-55 to 150	$^\circ\text{C}$

Stresses exceeding those listed in the Maximum Ratings table may damage the device. If any of these limits are exceeded, device functionality should not be assumed, damage may occur and reliability may be affected.

1. Mounted onto a $80 \times 80 \times 1.6\text{ mm}$ single layer FR4 board (100 sq mm, 1 oz. Cu, steady state).
2. Mounted onto a $80 \times 80 \times 1.6\text{ mm}$ single layer FR4 board (645 sq mm, 1 oz. Cu, steady state).
3. Load Dump Test B (with centralized load dump suppression) according to ISO16750-2 standard. Guaranteed by design. Not tested in production. Passed Class C according to ISO16750-1.

ESD ELECTRICAL CHARACTERISTICS (Note 4, 5)

Parameter	Test Condition	Symbol	Min	Typ	Max	Unit
Electro-Static Discharge Capability	Human Body Model (HBM)	ESD	4000	-	-	V
	Charged Device Model (CDM)		1000	-	-	

4. Not tested in production.
5. This device series incorporates ESD protection and is tested by the following methods:
 ESD Human Body Model tested per AEC-Q100-002 (JS-001-2017).
 Field Induced Charge Device Model ESD characterization is not performed on plastic molded packages with body sizes smaller than $2 \times 2\text{ mm}$ due to the inability of a small package body to acquire and retain enough charge to meet the minimum CDM discharge current waveform characteristic defined in JEDEC JS-002-2018.

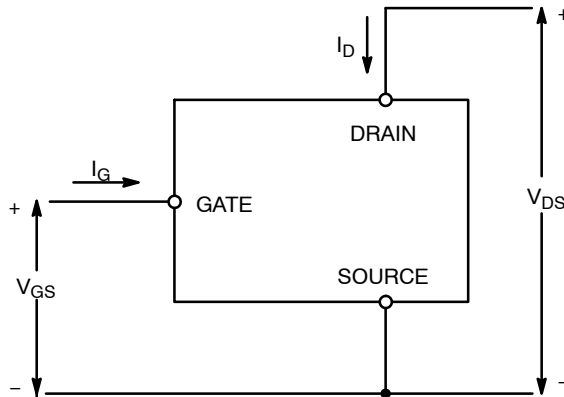

Figure 2. Voltage and Current Convention

NCV8415

ELECTRICAL CHARACTERISTICS (T_J = 25°C unless otherwise noted)

Parameter	Test Condition	Symbol	Min	Typ	Max	Unit
OFF CHARACTERISTICS						
Drain-to-Source Breakdown Voltage	V _{GS} = 0 V, I _D = 10 mA	V _{(BR)DSS}	42	46	51	V
	V _{GS} = 0 V, I _D = 10 mA, T _J = 150°C (Note 6)		42	44	51	
Zero Gate Voltage Drain Current	V _{GS} = 0 V, V _{DS} = 32 V	I _{DSS}	-	0.6	2.0	μA
	V _{GS} = 0 V, V _{DS} = 32 V, T _J = 150°C (Note 6)		-	2.4	10	
Gate Input Current	V _{GS} = 5 V, V _{DS} = 0 V	I _{GSS}	-	50	70	

ON CHARACTERISTICS

Gate Threshold Voltage	V _{GS} = V _{DS} , I _D = 150 μA	V _{GS(th)}	1.0	1.6	2.0	V
Gate Threshold Temperature Coefficient	V _{GS} = V _{DS} , I _D = 150 μA (Note 6)	V _{GS(th)} /T _J	-	-4.0	-	mV/°C
Static Drain-to-Source On Resistance	V _{GS} = 10 V, I _D = 1.4 A	R _{DS(ON)}	-	80	100	mΩ
	V _{GS} = 10 V, I _D = 1.4 A, T _J = 150°C (Note 6)		-	150	190	
	V _{GS} = 5.0 V, I _D = 1.4 A		-	105	120	
	V _{GS} = 5.0 V, I _D = 1.4 A, T _J = 150°C (Note 6)		-	185	210	
	V _{GS} = 5.0 V, I _D = 0.5 A		-	105	120	
	V _{GS} = 5.0 V, I _D = 0.5 A, T _J = 150°C (Note 6)		-	185	210	
Source-Drain Forward On Voltage	I _S = 7 A, V _{GS} = 0 V	V _{SD}	-	0.88	1.10	V

SWITCHING CHARACTERISTICS (Note 6)

Turn-On Time (10% V _{GS} to 90% I _D)	V _{GS} = 0 V to 5 V, V _{DD} = 12 V, I _D = 1 A	t _{ON}	-	30	35	μs	
Turn-Off Time (90% V _{GS} to 10% I _D)		t _{OFF}	-	44	55		
Turn-On Time (10% V _{GS} to 90% I _D)	V _{GS} = 0 V to 10 V, V _{DD} = 12 V, I _D = 1 A	t _{ON}	-	13	20	μs	
Turn-Off Time (90% V _{GS} to 10% I _D)		t _{OFF}	-	70	90		
Turn-On Rise Time (10% I _D to 90% I _D)		t _{rise}	-	9	15		
Turn-Off Fall Time (90% I _D to 10% I _D)		t _{fall}	-	29	40		
Slew Rate On (80% V _{DS} to 50% V _{DS})		-dV _{DS} /dt _{ON}	0.5	1.63	-		V/μs
Slew Rate Off (50% V _{DS} to 80% V _{DS})		dV _{DS} /dt _{OFF}	0.4	0.55	-		

SELF PROTECTION CHARACTERISTICS

Current Limit	V _{GS} = 5 V, V _{DS} = 10 V	I _{LIM}	7.0	8.8	11	A
	V _{GS} = 5 V, V _{DS} = 10 V, T _J = 150°C (Note 6)		6.4	7.9	9.1	
	V _{GS} = 10 V, V _{DS} = 10 V (Note 6)		5.2	8.2	11	
	V _{GS} = 10 V, V _{DS} = 10 V, T _J = 150°C (Note 6)		5.0	7.4	10	
Temperature Limit (Turn-Off)	V _{GS} = 5.0 V (Note 6)	T _{LIM(OFF)}	150	175	185	°C
Thermal Hysteresis		ΔT _{LIM(ON)}	-	15	-	
Temperature Limit (Turn-Off)	V _{GS} = 10 V (Note 6)	T _{LIM(OFF)}	150	185	200	°C
Thermal Hysteresis		ΔT _{LIM(ON)}	-	15	-	

GATE INPUT CHARACTERISTICS (Note 6)

Device ON Gate Input Current	V _{GS} = 5 V, V _{DS} = 10 V, I _D = 1 A	I _{GON}	35	50	70	μA
	V _{GS} = 10 V, V _{DS} = 10 V, I _D = 1 A		250	310	450	
Current Limit Gate Input Current	V _{GS} = 5 V, V _{DS} = 10 V	I _{GCL}	45	76	95	μA
	V _{GS} = 10 V, V _{DS} = 10 V		320	450	550	
Thermal Limit Gate Input Current	V _{GS} = 5 V, V _{DS} = 10 V, I _D = 0 A	I _{GTL}	210	240	260	μA
	V _{GS} = 10 V, V _{DS} = 10 V, I _D = 0 A		620	700	830	

Product parametric performance is indicated in the Electrical Characteristics for the listed test conditions, unless otherwise noted. Product performance may not be indicated by the Electrical Characteristics if operated under different conditions.

6. Not subject to production testing.

TYPICAL PERFORMANCE CURVES

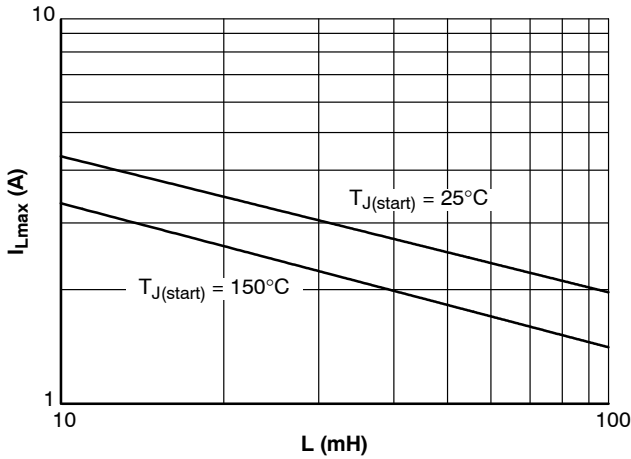

Figure 3. Single Pulse Maximum Switch-Off Current vs. Load Inductance

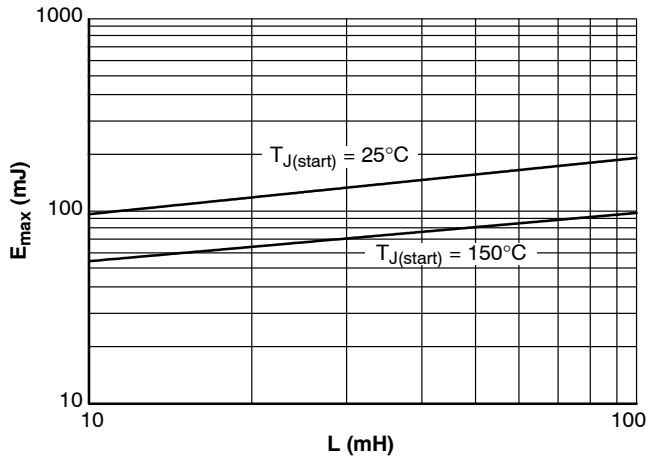

Figure 4. Single Pulse Maximum Switching Energy vs. Load Inductance

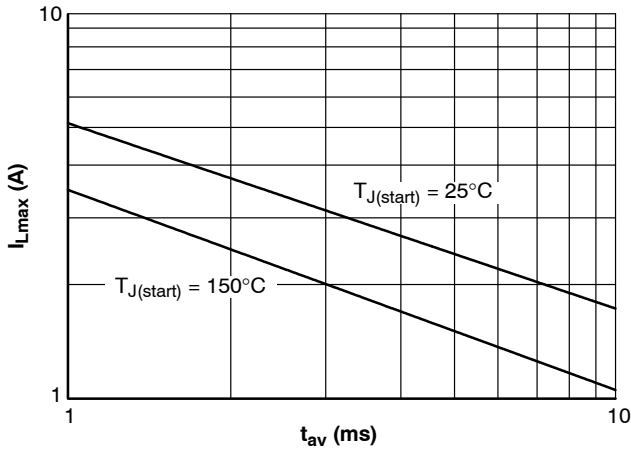

Figure 5. Single Pulse Maximum Inductive Switch-Off Current vs. Time in Avalanche

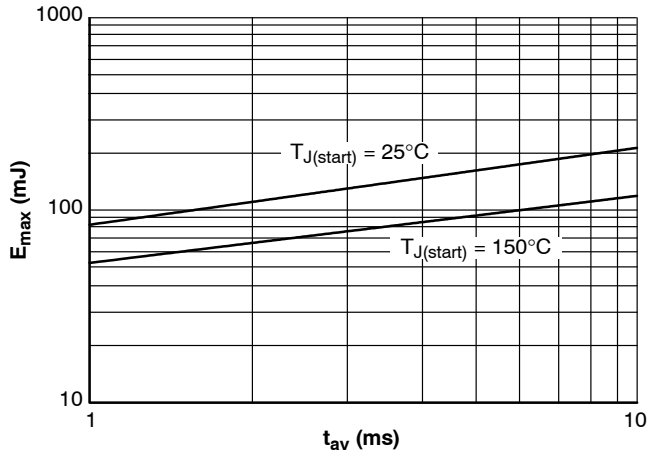

Figure 6. Single Pulse Maximum Inductive Switching Energy vs. Time in Avalanche

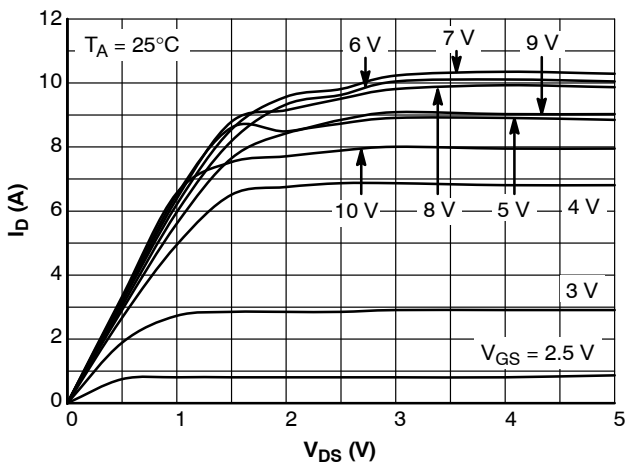

Figure 7. On-State Output Characteristics

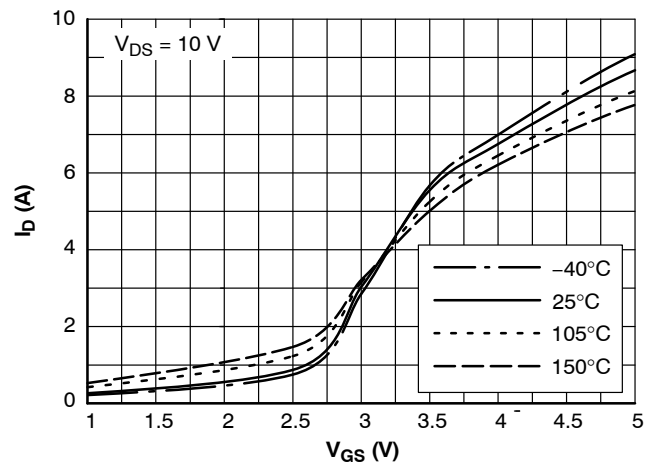

Figure 8. Transfer Characteristics

TYPICAL PERFORMANCE CURVES

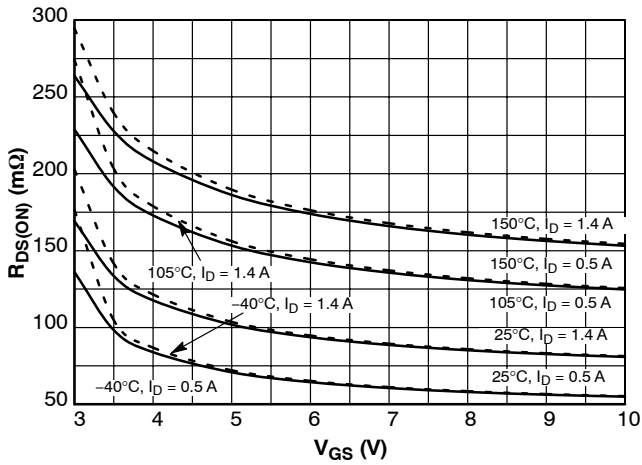

Figure 9. $R_{DS(ON)}$ vs. Gate-Source Voltage

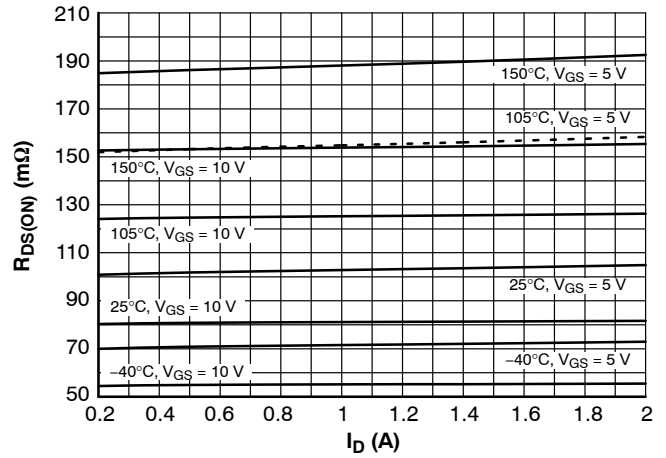

Figure 10. $R_{DS(ON)}$ vs. Drain Current

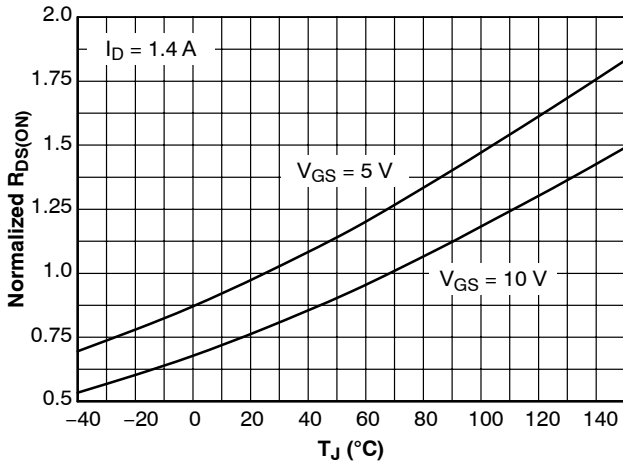

Figure 11. Normalized $R_{DS(ON)}$ vs. Temperature

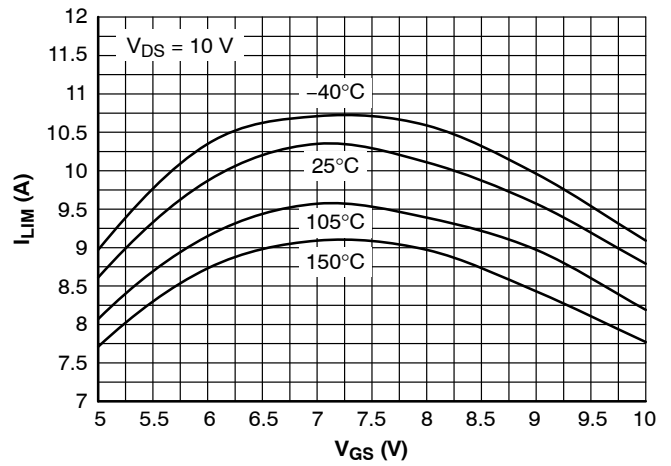

Figure 12. Current Limit vs. Gate-Source Voltage

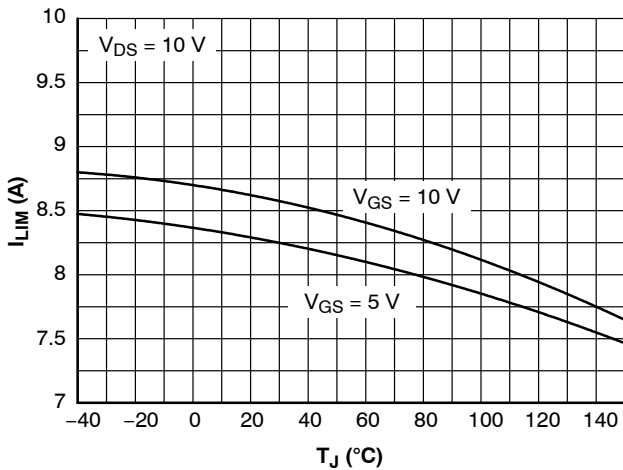

Figure 13. Current Limit vs. Junction Temperature

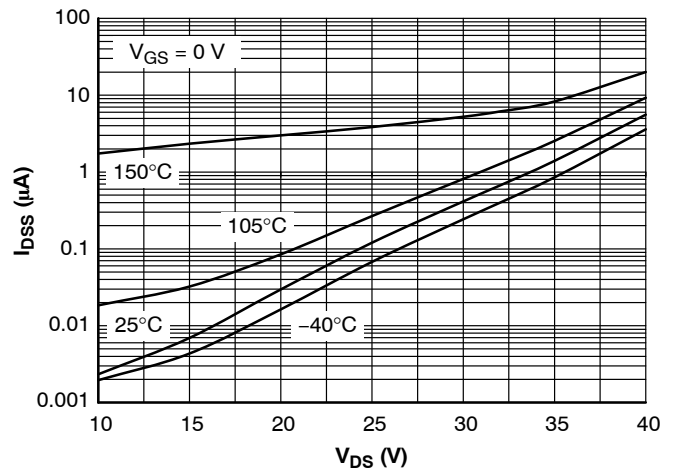

Figure 14. Drain-to-Source Leakage Current

TYPICAL PERFORMANCE CURVES

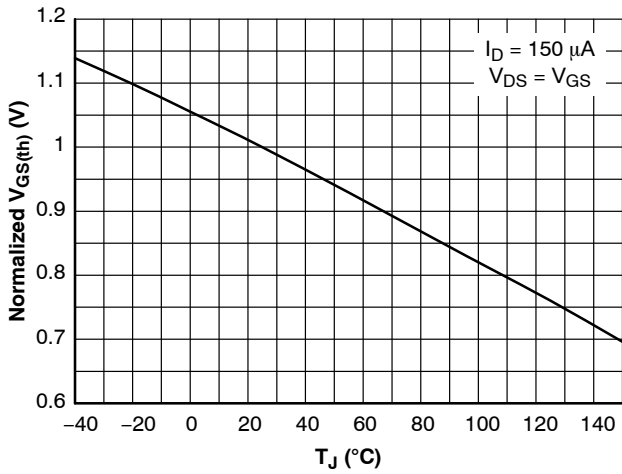

Figure 15. Normalized Threshold Voltage vs. Temperature

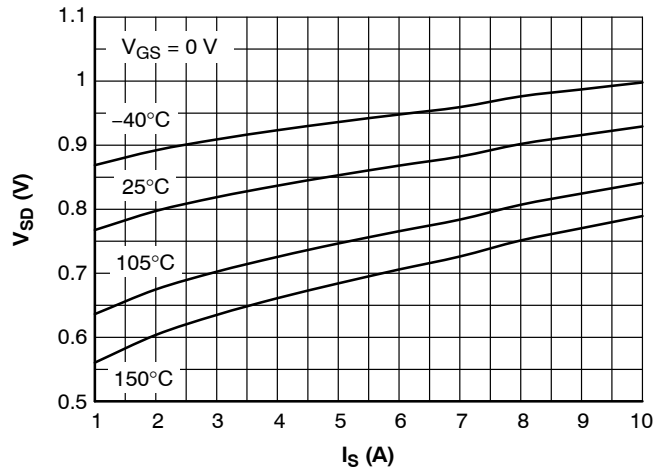

Figure 16. Source-Drain Diode Forward Characteristics

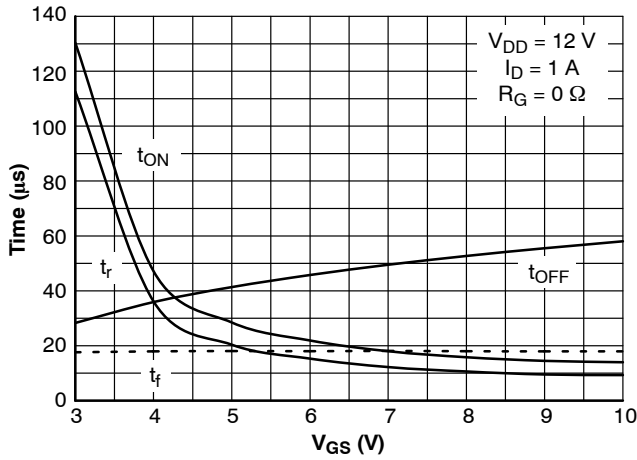

Figure 17. Resistive Load Switching Time vs. Gate-Source Voltage

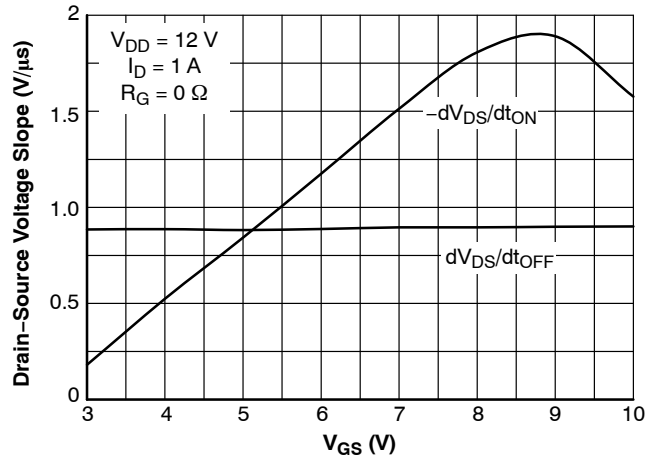

Figure 18. Resistive Load Switching Drain-Source Voltage Slope vs. Gate-Source Voltage

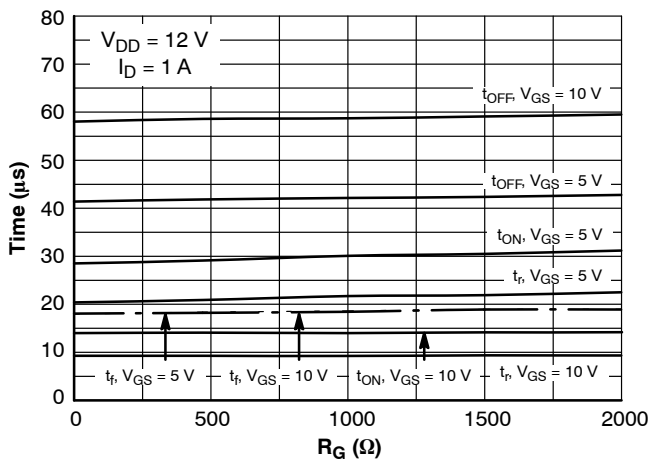

Figure 19. Resistive Load Switching Time vs. Gate Resistance

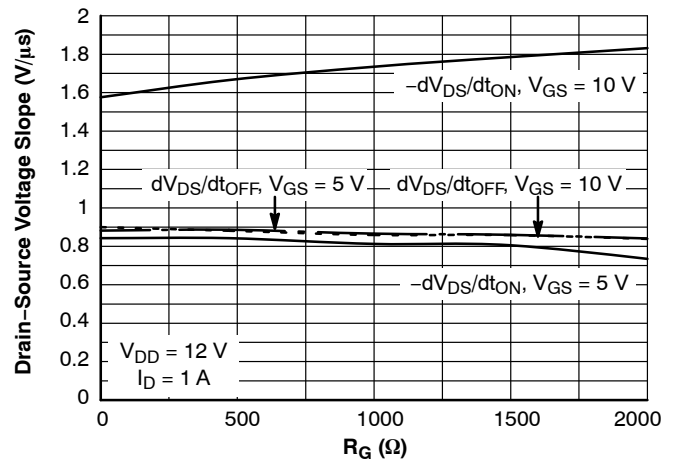

Figure 20. Resistive Load Switching Drain-Source Voltage Slope vs. Gate Resistance

TYPICAL PERFORMANCE CURVES

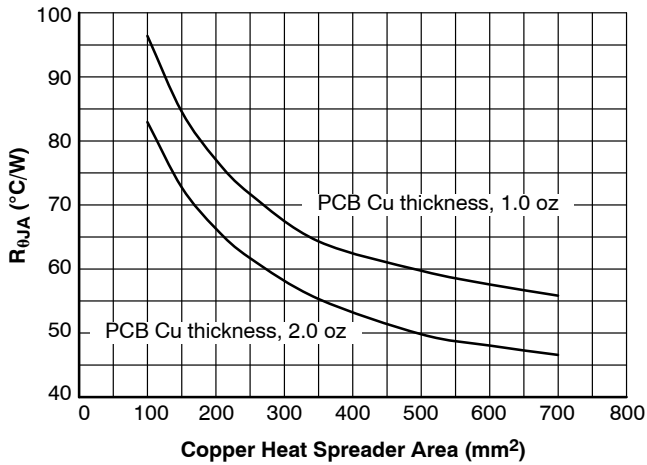

Figure 21. $R_{\theta JA}$ vs. Copper Area (SOT-223)

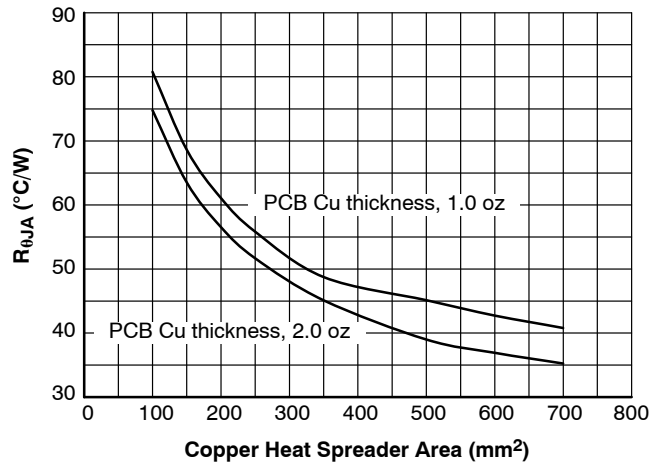

Figure 22. $R_{\theta JA}$ vs. Copper Area (DPAK)

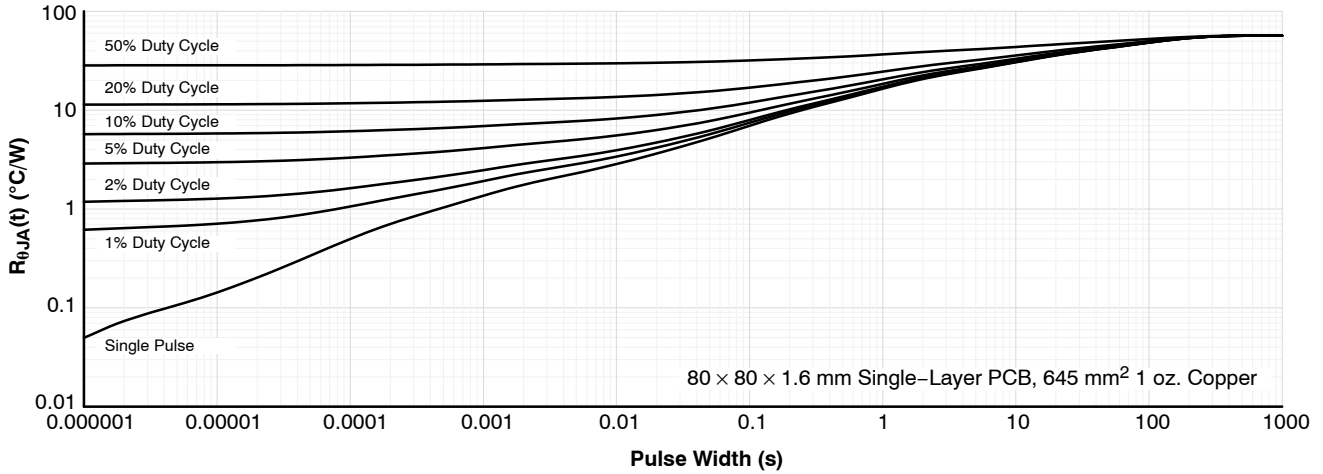

Figure 23. Transient Thermal Resistance (SOT-223)

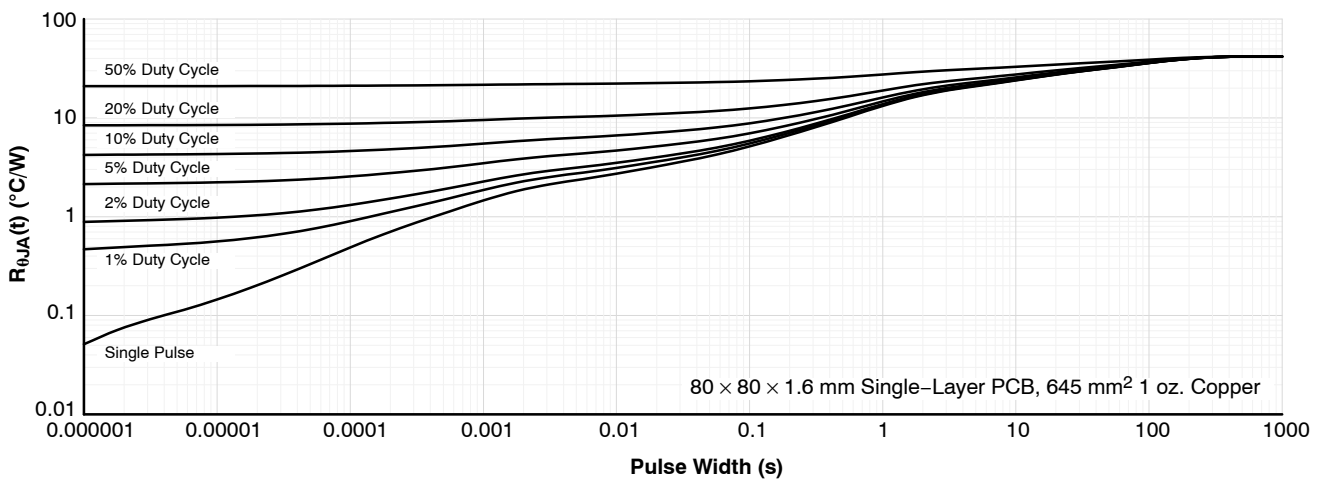

Figure 24. Transient Thermal Resistance (DPAK)

APPLICATION INFORMATION

Circuit Protection Features

The NCV8415 has three main protections. Current Limit, Thermal Shutdown and Delta Thermal Shutdown. These protections establish robustness of the NCV8415.

Current Limit and Short Circuit Protection

The NCV8415 has current sense element. In the event that the drain current reaches designed current limit level, integrated Current Limit protection establishes its constant level.

Delta Thermal Shutdown

Delta Thermal Shutdown (DTSD) Protection increases higher reliability of the NCV8415. DTSD consist of two independent temperature sensors – cold and hot sensors. The NCV8415 establishes a slow junction temperature rise by sensing the difference between the hot and cold sensors. ON/OFF output cycling is designed with hysteresis that results in a controlled saw tooth temperature profile (Figure 26). The die temperature slowly rises (DTSD) until the absolute temperature shutdown (TSD) is reached around 175°C.

Thermal Shutdown with Automatic Restart

Internal Thermal Shutdown (TSD) circuitry is provided to protect the NCV8415 in the event that the maximum

junction temperature is exceeded. When activated at typically 175°C, the NCV8415 turns off. This feature is provided to prevent failures from accidental overheating.

EMC Performance

To improve the EMC performance/robustness, connect a small ceramic capacitor to the drain pin as close to the device as possible according to Figure 25.

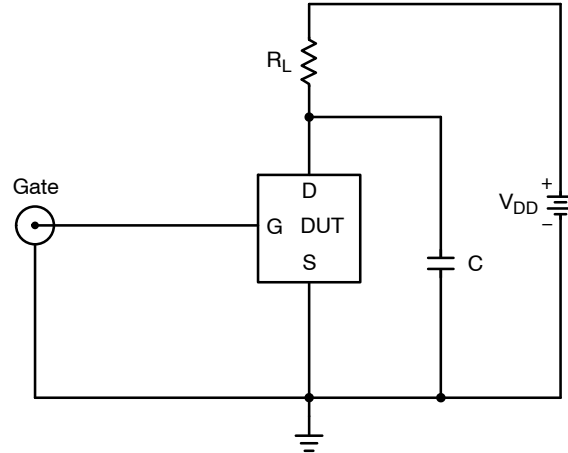

Figure 25. EMC Capacitor Placement

TEST CIRCUITS AND WAVEFORMS

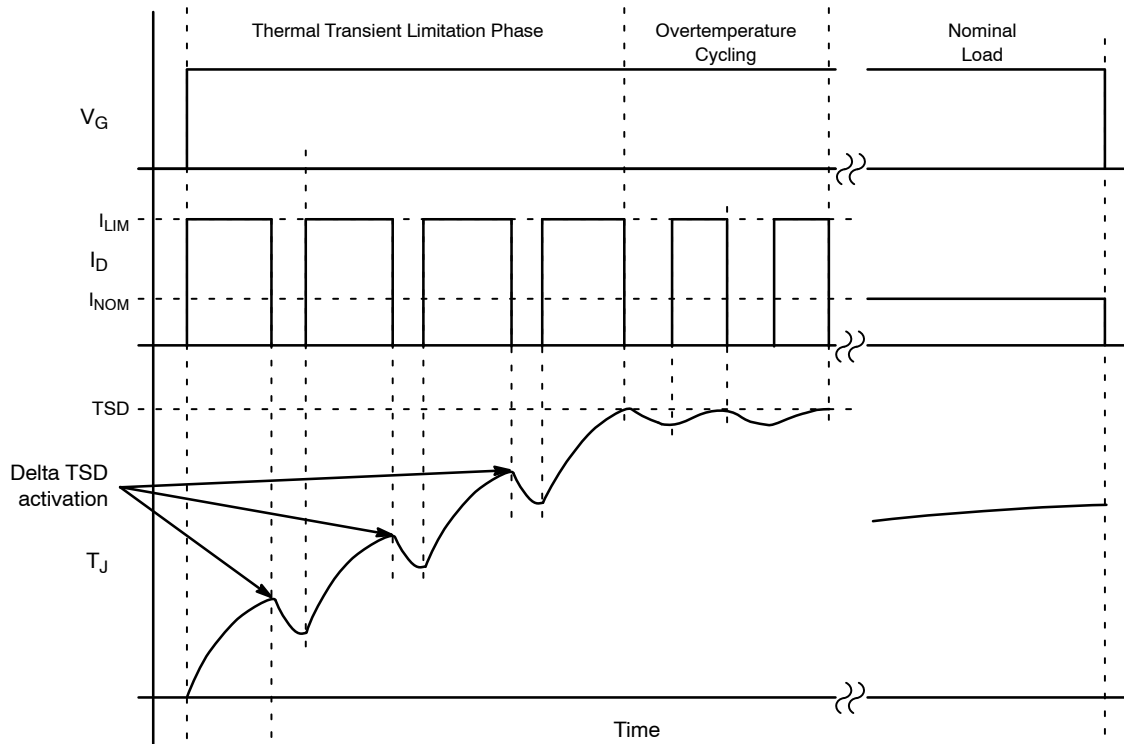

Figure 26. Overload Protection Behavior

TEST CIRCUITS AND WAVEFORMS

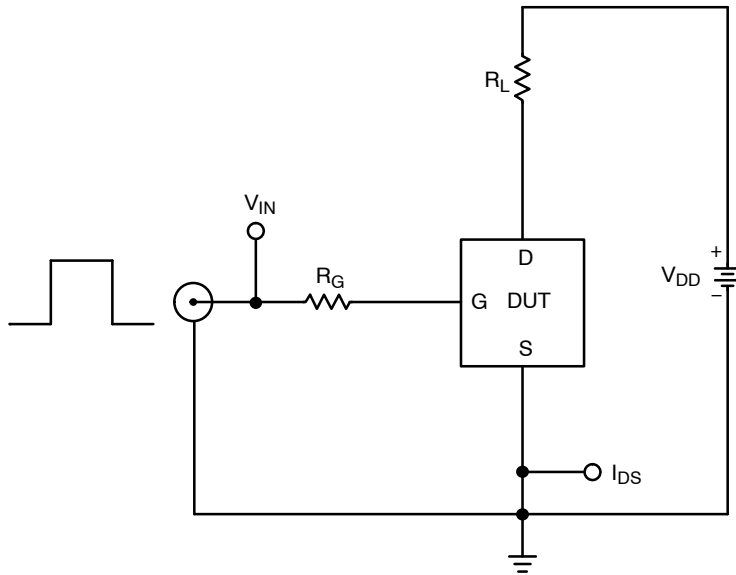

Figure 27. Resistive Load Switching Test Circuit

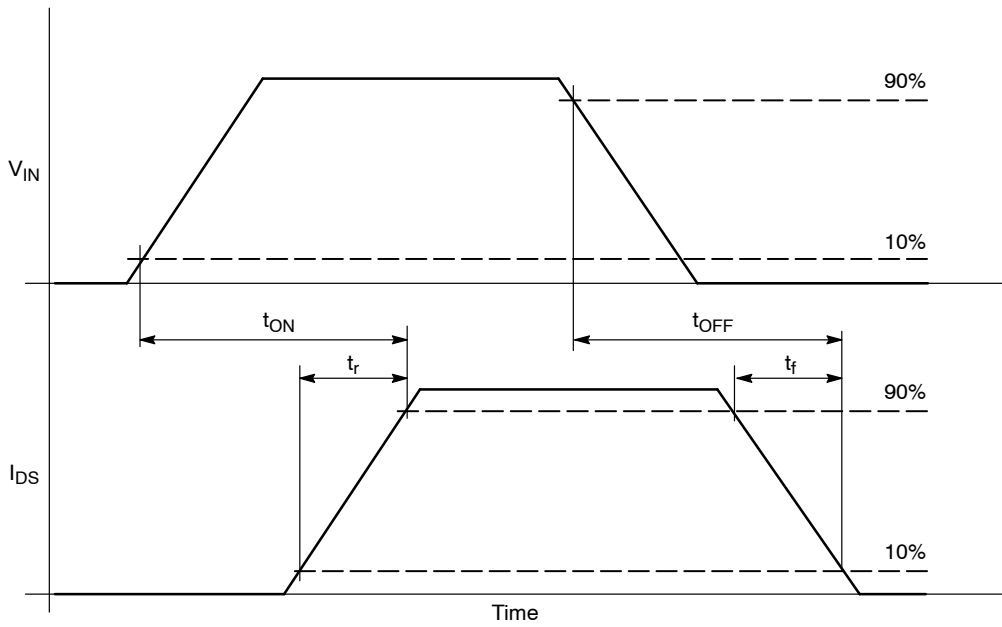

Figure 28. Resistive Load Switching Waveforms

TEST CIRCUITS AND WAVEFORMS

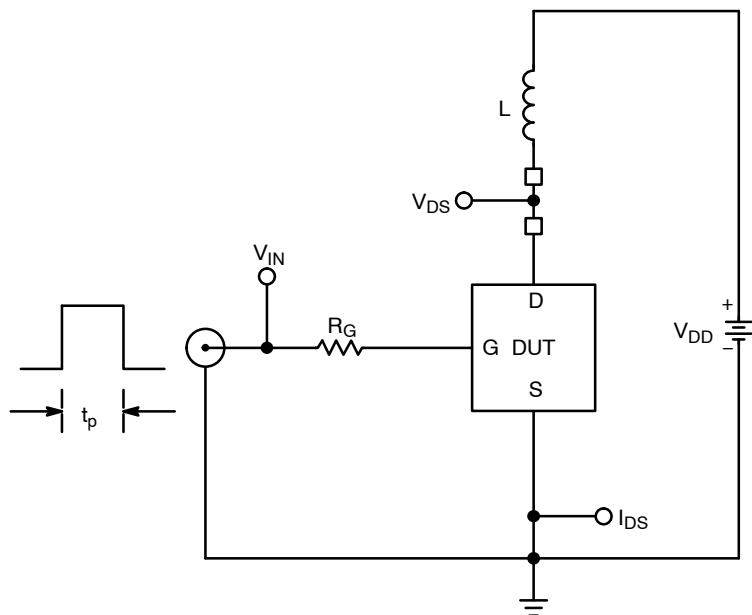

Figure 29. Inductive Load Switching Test Circuit

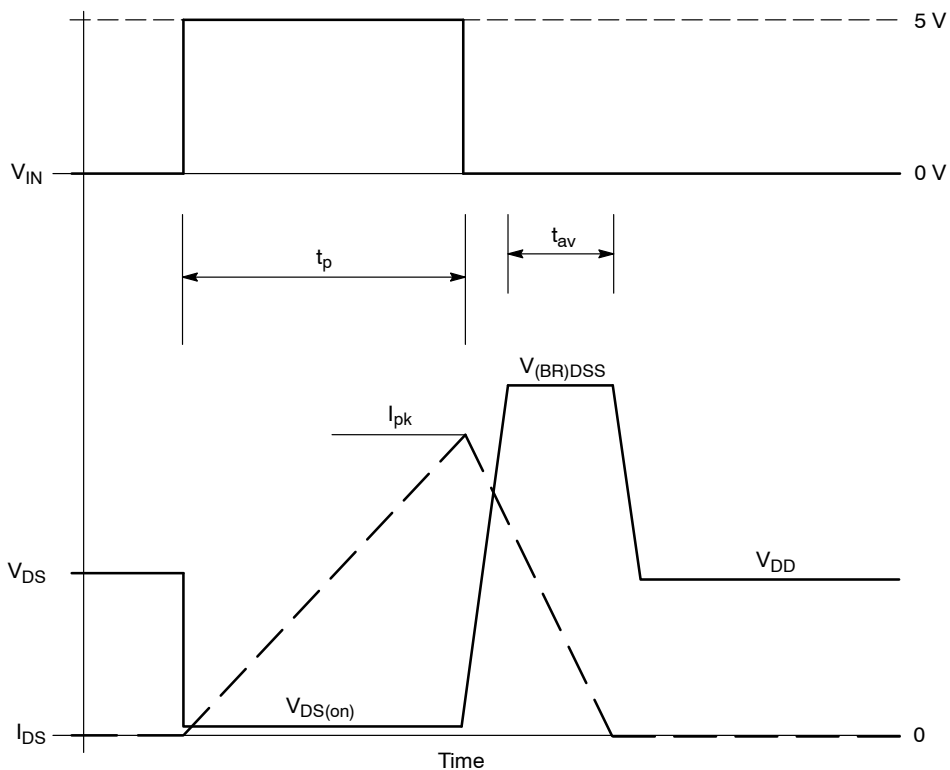

Figure 30. Inductive Load Switching Waveforms

MECHANICAL CASE OUTLINE

PACKAGE DIMENSIONS

ON Semiconductor®



SCALE 1:1

SOT-223 (TO-261)
CASE 318E-04
ISSUE R

DATE 02 OCT 2018

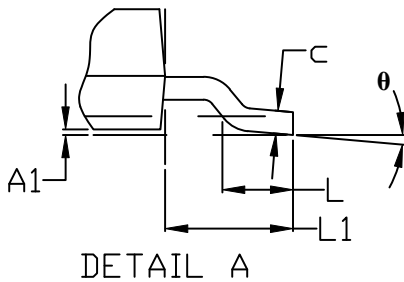
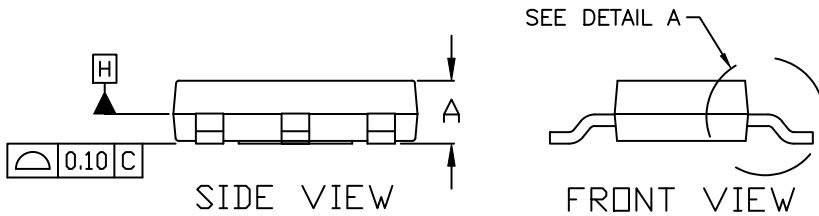
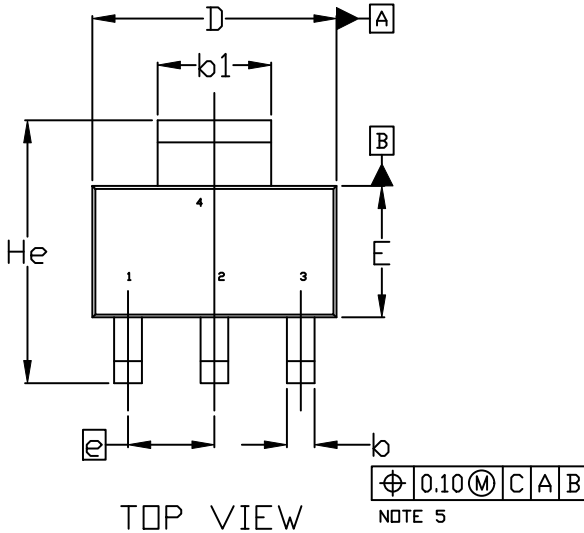

NOTES:

1. DIMENSIONING AND TOLERANCING PER ASME Y14.5M, 1994.
2. CONTROLLING DIMENSION: MILLIMETERS
3. DIMENSIONS D & E DO NOT INCLUDE MOLD FLASH, PROTRUSIONS OR GATE BURRS. MOLD FLASH, PROTRUSIONS OR GATE BURRS SHALL NOT EXCEED 0.200MM PER SIDE.
4. DATUMS A AND B ARE DETERMINED AT DATUM H.
5. A1 IS DEFINED AS THE VERTICAL DISTANCE FROM THE SEATING PLANE TO THE LOWEST POINT OF THE PACKAGE BODY.
6. POSITIONAL TOLERANCE APPLIES TO DIMENSIONS b AND b1.

MILLIMETERS			
DIM	MIN.	NOM.	MAX.
A	1.50	1.63	1.75
A1	0.02	0.06	0.10
b	0.60	0.75	0.89
b1	2.90	3.06	3.20
c	0.24	0.29	0.35
D	6.30	6.50	6.70
E	3.30	3.50	3.70
e	2.30 BSC		
L	0.20	---	---
L1	1.50	1.75	2.00
He	6.70	7.00	7.30
θ	0°	---	10°

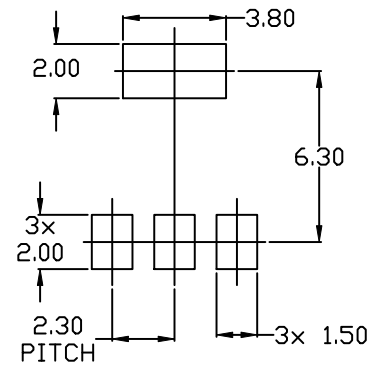

DOCUMENT NUMBER:	98ASB42680B	Electronic versions are uncontrolled except when accessed directly from the Document Repository. Printed versions are uncontrolled except when stamped "CONTROLLED COPY" in red.
DESCRIPTION:	SOT-223 (TO-261)	PAGE 1 OF 2

ON Semiconductor and are trademarks of Semiconductor Components Industries, LLC dba ON Semiconductor or its subsidiaries in the United States and/or other countries. ON Semiconductor reserves the right to make changes without further notice to any products herein. ON Semiconductor makes no warranty, representation or guarantee regarding the suitability of its products for any particular purpose, nor does ON Semiconductor assume any liability arising out of the application or use of any product or circuit, and specifically disclaims any and all liability, including without limitation special, consequential or incidental damages. ON Semiconductor does not convey any license under its patent rights nor the rights of others.

SOT-223 (TO-261)
CASE 318E-04
ISSUE R

DATE 02 OCT 2018

- | | | | | |
|--|---|---|---|---|
| STYLE 1:
PIN 1. BASE
2. COLLECTOR
3. EMITTER
4. COLLECTOR | STYLE 2:
PIN 1. ANODE
2. CATHODE
3. NC
4. CATHODE | STYLE 3:
PIN 1. GATE
2. DRAIN
3. SOURCE
4. DRAIN | STYLE 4:
PIN 1. SOURCE
2. DRAIN
3. GATE
4. DRAIN | STYLE 5:
PIN 1. DRAIN
2. GATE
3. SOURCE
4. GATE |
| STYLE 6:
PIN 1. RETURN
2. INPUT
3. OUTPUT
4. INPUT | STYLE 7:
PIN 1. ANODE 1
2. CATHODE
3. ANODE 2
4. CATHODE | STYLE 8:
CANCELLED | STYLE 9:
PIN 1. INPUT
2. GROUND
3. LOGIC
4. GROUND | STYLE 10:
PIN 1. CATHODE
2. ANODE
3. GATE
4. ANODE |
| STYLE 11:
PIN 1. MT 1
2. MT 2
3. GATE
4. MT 2 | STYLE 12:
PIN 1. INPUT
2. OUTPUT
3. NC
4. OUTPUT | STYLE 13:
PIN 1. GATE
2. COLLECTOR
3. EMITTER
4. COLLECTOR | | |

**GENERIC
 MARKING DIAGRAM***



- A = Assembly Location
- Y = Year
- W = Work Week
- XXXXX = Specific Device Code
- = Pb-Free Package

(Note: Microdot may be in either location)

*This information is generic. Please refer to device data sheet for actual part marking. Pb-Free indicator, "G" or microdot "▪", may or may not be present. Some products may not follow the Generic Marking.

DOCUMENT NUMBER:	98ASB42680B	Electronic versions are uncontrolled except when accessed directly from the Document Repository. Printed versions are uncontrolled except when stamped "CONTROLLED COPY" in red.
DESCRIPTION:	SOT-223 (TO-261)	PAGE 2 OF 2

ON Semiconductor and are trademarks of Semiconductor Components Industries, LLC dba ON Semiconductor or its subsidiaries in the United States and/or other countries. ON Semiconductor reserves the right to make changes without further notice to any products herein. ON Semiconductor makes no warranty, representation or guarantee regarding the suitability of its products for any particular purpose, nor does ON Semiconductor assume any liability arising out of the application or use of any product or circuit, and specifically disclaims any and all liability, including without limitation special, consequential or incidental damages. ON Semiconductor does not convey any license under its patent rights nor the rights of others.

MECHANICAL CASE OUTLINE

PACKAGE DIMENSIONS

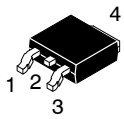

DPAK (SINGLE GAUGE)

CASE 369C

ISSUE F

DATE 21 JUL 2015

SCALE 1:1



NOTES:

- DIMENSIONING AND TOLERANCING PER ASME Y14.5M, 1994.
- CONTROLLING DIMENSION: INCHES.
- THERMAL PAD CONTOUR OPTIONAL WITHIN DIMENSIONS b3, L3 and Z.
- DIMENSIONS D AND E DO NOT INCLUDE MOLD FLASH, PROTRUSIONS, OR BURRS. MOLD FLASH, PROTRUSIONS, OR GATE BURRS SHALL NOT EXCEED 0.006 INCHES PER SIDE.
- DIMENSIONS D AND E ARE DETERMINED AT THE OUTERMOST EXTREMES OF THE PLASTIC BODY.
- DATUMS A AND B ARE DETERMINED AT DATUM PLANE H.
- OPTIONAL MOLD FEATURE.

DIM	INCHES		MILLIMETERS	
	MIN	MAX	MIN	MAX
A	0.086	0.094	2.18	2.38
A1	0.000	0.005	0.00	0.13
b	0.025	0.035	0.63	0.89
b2	0.028	0.045	0.72	1.14
b3	0.180	0.215	4.57	5.46
c	0.018	0.024	0.46	0.61
c2	0.018	0.024	0.46	0.61
D	0.235	0.245	5.97	6.22
E	0.250	0.265	6.35	6.73
e	0.090	BSC	2.29	BSC
H	0.370	0.410	9.40	10.41
L	0.055	0.070	1.40	1.78
L1	0.114	REF	2.90	REF
L2	0.020	BSC	0.51	BSC
L3	0.035	0.050	0.89	1.27
L4	---	0.040	---	1.01
Z	0.155	---	3.93	---

GENERIC MARKING DIAGRAM*

- | | | | | |
|--|--|---|---|--|
| <p>STYLE 1:
PIN 1. BASE
2. COLLECTOR
3. EMITTER
4. COLLECTOR</p> | <p>STYLE 2:
PIN 1. GATE
2. DRAIN
3. SOURCE
4. DRAIN</p> | <p>STYLE 3:
PIN 1. ANODE
2. CATHODE
3. ANODE
4. CATHODE</p> | <p>STYLE 4:
PIN 1. CATHODE
2. ANODE
3. GATE
4. ANODE</p> | <p>STYLE 5:
PIN 1. GATE
2. ANODE
3. CATHODE
4. ANODE</p> |
| <p>STYLE 6:
PIN 1. MT1
2. MT2
3. GATE
4. MT2</p> | <p>STYLE 7:
PIN 1. GATE
2. COLLECTOR
3. EMITTER
4. COLLECTOR</p> | <p>STYLE 8:
PIN 1. N/C
2. CATHODE
3. ANODE
4. CATHODE</p> | <p>STYLE 9:
PIN 1. ANODE
2. CATHODE
3. RESISTOR ADJUST
4. CATHODE</p> | <p>STYLE 10:
PIN 1. CATHODE
2. ANODE
3. CATHODE
4. ANODE</p> |

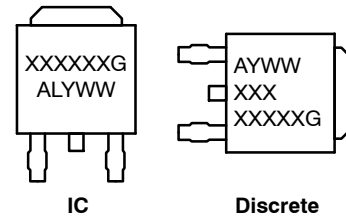

- XXXXXX = Device Code
 A = Assembly Location
 L = Wafer Lot
 Y = Year
 WW = Work Week
 G = Pb-Free Package

SOLDERING FOOTPRINT*

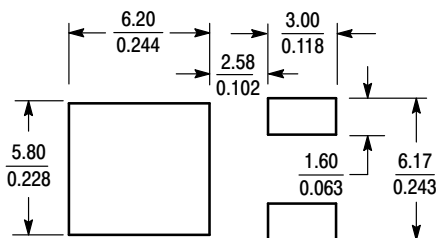

SCALE 3:1 (mm/inches)

*For additional information on our Pb-Free strategy and soldering details, please download the ON Semiconductor Soldering and Mounting Techniques Reference Manual, SOLDERRM/D.

*This information is generic. Please refer to device data sheet for actual part marking. Pb-Free indicator, "G" or microdot "•", may or may not be present. Some products may not follow the Generic Marking.

DOCUMENT NUMBER:	98AON10527D	Electronic versions are uncontrolled except when accessed directly from the Document Repository. Printed versions are uncontrolled except when stamped "CONTROLLED COPY" in red.
DESCRIPTION:	DPAK (SINGLE GAUGE)	PAGE 1 OF 1

onsemi and ONSEMI are trademarks of Semiconductor Components Industries, LLC dba onsemi or its subsidiaries in the United States and/or other countries. onsemi reserves the right to make changes without further notice to any products herein. onsemi makes no warranty, representation or guarantee regarding the suitability of its products for any particular purpose, nor does onsemi assume any liability arising out of the application or use of any product or circuit, and specifically disclaims any and all liability, including without limitation special, consequential or incidental damages. onsemi does not convey any license under its patent rights nor the rights of others.

onsemi, **Onsemi**, and other names, marks, and brands are registered and/or common law trademarks of Semiconductor Components Industries, LLC dba "**onsemi**" or its affiliates and/or subsidiaries in the United States and/or other countries. **onsemi** owns the rights to a number of patents, trademarks, copyrights, trade secrets, and other intellectual property. A listing of **onsemi**'s product/patent coverage may be accessed at www.onsemi.com/site/pdf/Patent-Marking.pdf. **onsemi** reserves the right to make changes at any time to any products or information herein, without notice. The information herein is provided "as-is" and **onsemi** makes no warranty, representation or guarantee regarding the accuracy of the information, product features, availability, functionality, or suitability of its products for any particular purpose, nor does **onsemi** assume any liability arising out of the application or use of any product or circuit, and specifically disclaims any and all liability, including without limitation special, consequential or incidental damages. Buyer is responsible for its products and applications using **onsemi** products, including compliance with all laws, regulations and safety requirements or standards, regardless of any support or applications information provided by **onsemi**. "Typical" parameters which may be provided in **onsemi** data sheets and/or specifications can and do vary in different applications and actual performance may vary over time. All operating parameters, including "Typicals" must be validated for each customer application by customer's technical experts. **onsemi** does not convey any license under any of its intellectual property rights nor the rights of others. **onsemi** products are not designed, intended, or authorized for use as a critical component in life support systems or any FDA Class 3 medical devices or medical devices with a same or similar classification in a foreign jurisdiction or any devices intended for implantation in the human body. Should Buyer purchase or use **onsemi** products for any such unintended or unauthorized application, Buyer shall indemnify and hold **onsemi** and its officers, employees, subsidiaries, affiliates, and distributors harmless against all claims, costs, damages, and expenses, and reasonable attorney fees arising out of, directly or indirectly, any claim of personal injury or death associated with such unintended or unauthorized use, even if such claim alleges that **onsemi** was negligent regarding the design or manufacture of the part. **onsemi** is an Equal Opportunity/Affirmative Action Employer. This literature is subject to all applicable copyright laws and is not for resale in any manner.

PUBLICATION ORDERING INFORMATION

LITERATURE FULFILLMENT:

Email Requests to: orderlit@onsemi.com

onsemi Website: www.onsemi.com

TECHNICAL SUPPORT

North American Technical Support:

Voice Mail: 1 800-282-9855 Toll Free USA/Canada

Phone: 011 421 33 790 2910

Europe, Middle East and Africa Technical Support:

Phone: 00421 33 790 2910

For additional information, please contact your local Sales Representative