

Micro-controller X

Model: PXR4/5/9

Operation Manual

Table of Contents

1. Part Names and Functions	6
2. Operations	7
2-1 Parameter list	7
2-2 Basic operations	12
2-3 Parameter functions and method of settings	14
Manual mode setting	15
Standby setting	16
Local/remote operation setting	17
Ramp-soak control	18
Canceling the alarm latch	19
Auto-tuning function	20
Displaying ON-delay alarm or the remaining time of timers	21
Setting alarm 1, 2 and 3	22
Upper limit of alarm 1, 2 and 3	22
Lower limit of alarm 1, 2 and 3	22
Key lock	23
Proportional band	24
Integral time	25
Derivative time	26
Hysteresis range for ON/OFF control	27
Cooling-side proportional band coefficient	28
Cooling-side proportional band shift (Dead band/Overlap band)	29
Output offset value	30
Anti-reset windup	30
Control algorithm	31
PV (Measured value) stable range	35
HYS (Hysteresis) mode at ON/OFF control	36
Cycle time of control output 1	37
Cycle time of control output 2 (Cooling-side)	38
Input signal code	39
Setting the measuring range (Input range)	40
Selection °C / °F	40
Decimal point position	42
PV (Measured value) offset	43
SV (Setting value) offset	44
Time constant of input filter	45
Alarm types	46
Selecting ramp-soak patterns	49
Ramp-soak status display	50
1st to 8th target SV	50
1st to 8th ramp segment time	50
1st to 8th soak segment time	50
Ramp-soak modes	50

Specifying control action and output direction at input burn-out	53
SV (Setting value) lower limiter	54
SV (Setting value) upper limiter	54
The time of ON-delay alarm or timer function	55
Displaying current detector input	57
HB (Set value of heater break alarm)	57
Hysteresis alarm 1, 2 and 3	59
Options of alarm 1, 2 and 3	60
Upper and lower limits for control output 1	62
Upper and lower limits for control output 2	62
Output limit types	63
Output value display	64
RCJ (Cold junction compensation)	65
Adjusting the PV (Measured value) display (0%)	66
Adjusting the PV (Measured value) display (100%)	66
DI1/2 (Digital input 1/2) operation	67
Station No. for communication	70
Parity for communication	71
Communication protocol setting	72
Re-transmission output type setting	73
Re-transmission base and span scale	74
Remote SV input (0%) adjustment	75
Remote SV input (100%) adjustment	75
Remote SV input filter constant	76
Remote SV input value display	77
Parameter display mask	78
3. Troubleshooting	79
Index	81

PXR4

Digit	Specification	Note	4	5	6	7	8	9	10	11	12	13
4	<Front dimensions> 48 X 48mm		↓									
5	<Input signal> Thermocouple °C Thermocouple °F Resistance bulb Pt100 3-wire type °C Resistance bulb Pt100 3-wire type °F 1 to 5V DC 4 to 20mA DC		↓	T R N S A B								
6	<Control output 1> Relay contact output Voltage pulse output (24V DC) 4 to 20mA DC output	Note 1			A C E							
7	<Control output 2> None Relay contact output Voltage pulse output (24V DC) 4 to 20mA DC output Re-transmission output (4 to 20mA DC)	Note 2 Note 2 Note 2 Note 2				Y A C E R						
8	<Revision code>						1					
9	<Optional specifications 1> None Alarm (1 pc.) Alarm for heater break Alarm (1 pc.) + Alarm for heater break Ramp-soak Alarm (1 pc.) + Ramp-soak Alarm for heater break + Ramp-soak Alarm (1 pc.) + Alarm for heater break + Ramp-soak Alarm (2 pcs.) Alarm (2 pcs.) + Ramp-soak Alarm (2 pcs.) + Alarm for heater break + Ramp-soak Alarm (3 pcs.) Remote SV Remote SV + Alarm (2 pcs.)	Note 3 Note 3 Note 3 Note 3 Note 3 Note 3 Note 3 Note 3 Note 3 Note 3 Note 3 Note 3						0 1 2 3 4 5 6 7 F G H M D P				
10	<Instruction manual> <Power supply voltage> None 100 to 240V AC English 100 to 240V AC None 24V DC English 24V DC								N V C B			
11	<Optional specifications 2>									↓	↓	↓
12	None									0	0	0
13	RS485 (Modbus) communication									M	0	0
	RS485 (ASCII) communication									N	0	0
	Digital input 1 point									S	0	0
	Digital input 2 points									T	0	0
	RS485 (Modbus) communication + Digital input 1 point	Note 4								V	0	0
	RS485 (ASCII) communication + Digital input 1 point									W	0	0

Note 1: Cannot be combined with heater break alarm.

(2, 3, 6, 7, H cannot be specified on 9th digit.)

Note 2: Cannot be combined with alarm (1 pc.) + heater break alarm, alarm (2 pcs.), or alarm (3pcs.).

(3, 7, F, G, H, M, P cannot be specified on 9th digit.)

Note 3: Cannot be combined with RS485 + 1-point digital input.

(V and W cannot be specified on 11th digit.)

Note 4: In the case of control output 2, either of heater break alarm or remote SV input can be selected.

(A, C, E and R on the 7th digit, and 2,3,6,7,H, D and P on the 9th digit cannot be specified.)

Input signal, measurement range, and set value at the time of deliver are as follows.

When thermocouple is specified: Thermocouple K, Measurement range; 0 to 400°C, Set value; 0°C

When resistance bulb is specified: Pt, Measurement range; 0 to 150°C, Set value; 0°C

When voltage/current is specified: Scaling; 0 to 100%, Set value; 0%

For the cases other than the above, specify input signal and measurement range.

Input signal of the thermocouple and the resistance bulb can be switched by key operation on the front panel.

The actuating method of the control output has been set to reverse for control output 1, and to direct for control output 2 at the time of delivery. Note that reverse and direct actuation can be switched by key operation on the front panel.

PXR5/9

			4	5	6	7	8	9	10	11	12	13	
			PXR										
Digit	Specification	Note											
4	<Front dimensions> 48 X 96mm 96 X 96mm		↓										
5	<Input signal> Thermocouple °C Thermocouple °F Resistance bulb Pt100 3-wire type °C Resistance bulb Pt100 3-wire type °F 1 to 5V DC 4 to 20mA DC		5 9	↓									
6	<Control output 1> Relay contact output Voltage pulse output (24V DC) 4 to 20mA DC output	Note 1		T R N S A B	↓								
7	<Control output 2> None Relay contact output Voltage pulse output (24V DC) 4 to 20mA DC output Re-transmission output (4 to 20mA DC)				A C E	↓							
8	<Revision code>					Y A C E R	↓						
9	<Optional specifications 1> None Alarm (1 pc.) Alarm for heater break Alarm (1 pc.) + Alarm for heater break Ramp-soak Alarm (1 pc.) + Ramp-soak Alarm for heater break + Ramp-soak Alarm (1 pc.) + Alarm for heater break + Ramp-soak Alarm (2 pcs.) Alarm (2 pcs.) + Ramp-soak Alarm (2 pcs.) + Alarm for heater break + Ramp-soak Alarm (3 pcs.) Remote SV Remote SV + Alarm (2 pcs.)	Note 2 Note 2 Note 2 Note 2 Note 2 Note 2 Note 2 Note 2 Note 2 Note 2 Note 2					1						
10	<Instruction manual> <Power supply voltage> None 100 to 240V AC English 100 to 240V AC None 24V DC English 24V DC							0 1 2 3 4 5 6 7 F G H M D P					
11	<Optional specifications 2>								↓				
12	None								N V C B				
13	RS485 (Modbus) communication RS485 (ASCII) communication Digital input 1 point Digital input 2 points RS485 (Modbus) communication + Digital input 1 point RS485 (ASCII) communication + Digital input 1 point	Note 3								0 0 0 M 0 0 N 0 0 S 0 0 T 0 0 V 0 0 W 0 0			

- Note 1: Cannot be combined with heater break alarm.
(2, 3, 6, 7, H cannot be specified on 9th digit.)
- Note 2: Cannot be combined with RS485 + 1-point digital input.
(V and W cannot be specified on 11th digit.)
- Note 3: In the case of control output 2, either of heater break alarm or remote SV input can be selected.
(A, C, E and R on the 7th digit, and 2,3,6,7,H, D and P on the 9th digit cannot be specified.)

Input signal, measurement range, and set value at the time of deliver are as follows.
When thermocouple is specified: Thermocouple K, Measurement range; 0 to 400°C, Set value; 0°C
When resistance bulb is specified: Pt, Measurement range; 0 to 150°C, Set value; 0°C
When voltage/current is specified: Scaling; 0 to 100%, Set value; 0%

For the cases other than the above, specify input signal and measurement range.
 Input signal of the thermocouple and the resistance bulb can be switched by key operation on the front panel.

The actuating method of the control output has been set to reverse for control output 1, and to direct for control output 2 at the time of delivery. Note that reverse and direct actuation can be switched by key operation on the front panel.

1 Part Names and Functions

This chapter explains the part names and functions on the face panel. The face panel has the PV and SV displays, the status indicating lamp, and the setting keys, etc. Those functions are explained below. Please read and understand them before using the PXR. For details about the setting of parameters, see Chapter 2.

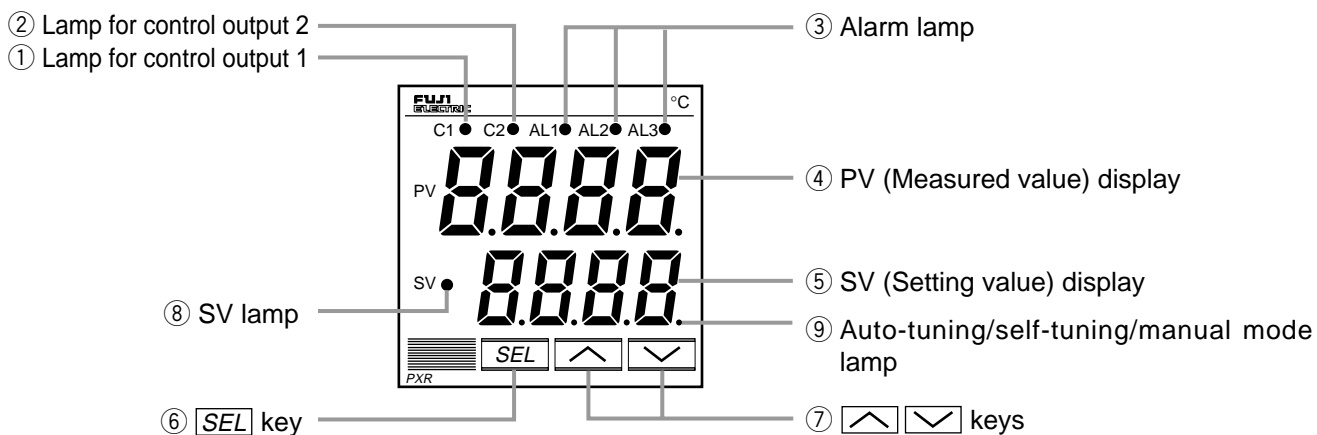

- ① Lamp for control output 1
Lights up while control output 1 stays ON.
- ② Lamp for control output 2
Lights up while control output 2 stays ON.
- ③ Alarm lamp
Lights up on detecting an alarm. The alarm output is turned ON at the same time.
If the optional heater break alarm is provided, the AL3 lamp lights up on detecting a heater break.
- ④ PV (Measured value) display
Displays the PV. When setting a parameter, its name appears.
- ⑤ SV (Setting value) display
Displays the SV. When setting a parameter, its value appears.
- ⑥ **SEL** key
Used to select a parameter block and a parameter, and register a set value.
- ⑦ keys
Used to change the SV, call parameters, and change parameter values.
- ⑧ SV lamp
Lights up while the SV is displayed in the SV display. When parameters and data are displayed, the SV lamp goes out.
- ⑨ Auto-tuning/self-tuning/manual mode lamp
Flashes under an auto-tuning or self-tuning operation. The lamp is kept on in manual mode.

2 Operations

This chapter explains how to set the SV (Setting value) and the parameters for the PXR.

2-1 Parameter list

Parameters for the PXR are classified into operation parameters, and the first block, the second block and the third block parameters according to the frequency of use. The second and the third block parameters are used at initialization or when they are absolutely necessary.

Operation parameter

Parameter display symbol	Parameter name	Description	Setting range and factory default setting (*)	Parameter mask DSP	Reference page
(PV)	Measured temperature (Measurement value)	Displays the currently measured temperature (Measurement value).	Setting not allowed.	dP13-64	See page 78 for the method of turning on/off PV.
(SV)	Set temperature (Set value)	Displays the set temperature (Set value).	0 to 100%FS (*: 0%FS)	Mask not allowed.	14

Parameters of the first block

Parameter display symbol	Parameter name	Description	Setting range and factory default setting (*)	User's set value	Parameter mask DSP	Reference page
MANU	Manual mode selection	Switches between Auto and Manual operation modes.	oN: Manual mode oFF: Auto mode*		dP13-32	15
STBY	Standby setting	Switches between RUN and Standby for control.	oN: Control standby (Output: OFF, Alarm: OFF) oFF: Control RUN*		dSP1-1	16
LOD	Remote/local setting	Switches between remote and local operations.	rEM: Remote LoCL: Local		dp13-8	17
PROG	Ramp-soak control		oFF: Stop* rUn: Start HLd: Hold		dSP1-2	18
LACH	Alarm latch cancel	Cancels the alarm latch.	0: Keeps the alarm latch.* 1: Opens up the alarm latch.		dSP1-4	19
AT	Auto-tuning	Used for setting the constants for P , I , and d by auto-tuning.	0: OFF (Resets the auto-tuning or does not use it.)* 1: ON (Performs the auto-tuning in the SV standard type.) 2: ON (Performs the auto-tuning in low PV type (SV value-10%FS).)		dSP1-8	20
TN-1	Timer 1 display	Displays the remaining time of timer 1.	- (Unit: seconds)		dSP1-16	21
TN-2	Timer 2 display	Displays the remaining time of timer 2.	- (Unit: seconds)		dSP1-32	21
TN-3	Timer 3 display	Displays the remaining time of timer 3.	- (Unit: seconds)		dSP1-64	21
AL1	Set value of alarm 1	Sets the value at which alarm 1 is detected.	AL1 is displayed when alarm type 1 is 0 to 15, or 32 to 34, and AL1-H or AL1-L is displayed when alarm type 1 is 16 to 31.		dSP1-128	22 *
AL1-L	Lower limit value of alarm 1	Sets the lower limit value at which alarm 1 is detected.			dSP2-1	22 *
AL1-H	Upper limit value of alarm 1	Sets the upper limit value at which alarm 1 is detected.			dSP2-2	22 *
AL2	Set value of alarm 2	Sets the value during which alarm 2 is detected.	AL2 is displayed when alarm type 2 is 0 to 15 or 32 to 34, and AL2-H or AL2-L is displayed when alarm type 2 is 16 to 31.		dSP2-4	22 *
AL2-L	Lower limit value of alarm 2	Sets the lower limit value at which alarm 2 is detected.			dSP2-8	22 *
AL2-H	Upper limit value of alarm 2	Sets the upper limit value at which alarm 2 is detected.			dSP2-16	22 *
AL3	Set value of alarm 3	Sets the value at which alarm 3 is detected.	AL3 is displayed when alarm type 3 is 0 to 15 or 32 to 34, and AL3-H or AL3-L is displayed when alarm type 3 is 16 to 31.		dSP2-32	22 *
AL3-L	Lower limit value of alarm 3	Sets the lower limit value at which alarm 3 is detected.			dSP2-64	22 *
AL3-H	Upper limit value of alarm 3	Sets the upper limit value at which alarm 3 is detected.			dSP2-128	22 *
LoC		Specifies whether or not to allow the change of parameters.	0: All settings are changeable both from the face panel and via communication.* 1: All settings are unchangeable from the face panel, but changeable via communication. 2: Only the SV is changeable from the face panel, and all settings are changeable via communication. 3: All settings are changeable from the face panel, but unchangeable via communication. 4: All settings are unchangeable from the face panel or via communication. 5: Only the SV is changeable from the face panel, but all settings are unchangeable via communication.		dSP3-1	23

Note: The parameters for which * is marked with the page number in Reference page are related to Remedies of "4" on page 79.

Parameters of the second block

Note: The parameters for which * is marked with the page number in Reference page are related to Remedies of "4" on page 79.

Parameter display symbol	Parameter name	Description	Setting range and factory default setting (*)	User's set value	Parameter mask DSP	Reference page
<i>P</i>	Proportional band	Set <i>P</i> to 0.0 to select the ON/OFF control (Two-position control).	0.0 to 999.9% (*: 5.0)		dSP3-2	24
<i>I</i>	Integral time		0 to 3200 seconds (*: 240)		dSP3-4	25
<i>D</i>	Derivative time		0.0 to 999.9 seconds (*: 60.0)		dSP3-8	26
<i>HYS</i>	Hysteresis range for ON/OFF control	Sets the hysteresis for ON/OFF control.	0 to 50%FS (*: equivalent of 1.0°C)		dSP3-16	27 *
<i>Cool</i>	Cooling-side proportional band coefficient		0.0 to 100.0 (*: 1.0)		dSP3-32	28
<i>db</i>	Cooling-side proportional band shift		-50.0 to +50.0 (*: 0.0)		dSP3-64	29
<i>bAL</i>	Output convergence value		-100 to 100% (*: single 0.0, dual 50.0)		dSP3-128	30
<i>Ar</i>	Anti-reset windup		0 to 100%FS (*: 100%FS)		dSP4-1	30 *
<i>CrL</i>	Control algorithm	Selects the control algorithm.	PID: Runs normal PID control.* FUZY: Runs PID control with fuzzy logic. SELF: Runs PID control with self-running.		dSP4-2	31
<i>SLFb</i>	PV (Measured value) stable range	Sets the PV stable range for the self-tuning operation.	0 to 100%FS (*: 2%FS)		dSP4-4	35 *
<i>onof</i>	Setting HYS (Hysteresis) mode	Selects the hysteresis operation at ON/OFF control.	oFF: Starts the two-position control at the values of SV+HYS/2 and SV-HYS/2. on: Starts the two-position control at the values of SV and SV+HYS, or SV and SV-HYS.*		dSP4-8	36
<i>FL</i>	Cycle time of control output 1	Not shown at 4-20mA DC output	RLY, SSR: 1 to 150 seconds (*: Contact output = 30, SSR/SSC-driven output = 2)		dSP4-16	37
<i>FL2</i>	Cycle time of control output 2 (cooling-side)		1 to 150 seconds (*: 30)		dSP4-32	38
<i>P-n2</i>	Input signal code	Set this parameter when changing the types of temperature sensors.	1 to 16 (*: specified by customer while ordering) Note 1		dSP4-64	39
<i>P-SL</i>	Lower limit of measuring range		-1999 to 9999 (*: specified by customer while ordering) Note 1		dSP4-128	40
<i>P-SU</i>	Upper limit of measuring range		-1999 to 9999 (*: specified by customer while ordering) Note 1		dSP5-1	40
<i>P-dP</i>	Setting the decimal point position		0 to 2 (*: specified by customer while ordering) Note 1		dSP5-2	42
<i>P-F</i>	°C / °F selection		°C / °F		dSP5-4	40
<i>PUDF</i>	PV (Measured value) offset		-10 to 10%FS (*: 0)		dSP5-8	43
<i>SUDF</i>	SV (Setting value) offset		-50 to 50%FS (*: 0)		dSP5-16	44 *
<i>P-dF</i>	Time constant of input filter		0.0 to 900.0 seconds (*: 5.0)		dSP5-32	45 *
<i>ALN1</i>	Alarm type 1	Sets the types of alarm operations.	0 to 34 (*: 0/5)		dSP5-64	46
<i>ALN2</i>	Alarm type 2	Sets the types of alarm operations.	0 to 34 (*: 0/9)		dSP5-128	46
<i>ALN3</i>	Alarm type 3	Sets the types of alarm operations.	0 to 34 (*: 0)		dSP6-1	46
<i>SRAR</i>	Status display of ramp-soak		- (*: OFF)		dSP6-2	50
<i>PRn</i>	Selecting ramp-soak execute type	Selects ramp-soak patterns.	1: Performs 1st to 4th segments.* 2: Performs 5th to 8th segments. 3: Performs 1st to 8th segments.		dSP6-4	49
<i>SU-1</i>	1st target value /Switching-SV value	Sets the 1st target SV of ramp-soak operation. / Selected at switching-SV function for DII	Within the SV limit. (*: 0%FS)		dSP6-8	50 *
<i>FR1r</i>	First ramp segment time	Sets the first ramp segment time.	0 to 99h59m (*: 0.00)		dSP6-16	50

Note: The parameters for which * is marked with the page number in Reference page are related to Remedies of “4” on page 79.

Parameter display symbol	Parameter name	Description	Setting range and factory default setting (*)	User's set value	Parameter mask DSP	Reference page
<i>r015</i>	1st soak segment time	Sets the 1st soak segment time.	0 to 99h59m (*: 0.00)		dSP6-32	50
<i>sv-2</i>	2nd target SV	Sets the 2nd target SV of ramp-soak operation.	Within the SV limit. (*: 0%FS)		dSP6-64	50*
<i>r02r</i>	2nd ramp segment time	Sets the 2nd ramp segment time.	0 to 99h59m (*: 0.00)		dSP6-128	50
<i>r025</i>	2nd soak segment time	Sets the 2nd soak segment time.	0 to 99h59m (*: 0.00)		dSP7-1	50
<i>sv-3</i>	3rd target SV	Sets the 3rd target SV of ramp-soak operation.	Within the SV limit. (*: 0%FS)		dSP7-2	50*
<i>r03r</i>	3rd ramp segment time	Sets the 3rd ramp segment time.	0 to 99h59m (*: 0.00)		dSP7-4	50
<i>r035</i>	3rd soak segment time	Sets the 3rd soak segment time.	0 to 99h59m (*: 0.00)		dSP7-8	50
<i>sv-4</i>	4th target SV	Sets the 4th target SV of ramp-soak operation.	Within the SV limit. (*: 0%FS)		dSP7-16	50*
<i>r04r</i>	4th ramp segment time	Sets the 4th ramp segment time.	0 to 99h59m (*: 0.00)		dSP7-32	50
<i>r045</i>	4th soak segment time	Sets the 4th soak segment time.	0 to 99h59m (*: 0.00)		dSP7-64	50
<i>sv-5</i>	5th target SV	Sets the 5th target SV of ramp-soak operation.	Within the SV limit. (*: 0%FS)		dSP7-128	50*
<i>r05r</i>	5th ramp segment time	Sets the 5th ramp segment time.	0 to 99h59m (*: 0.00)		dSP8-1	50
<i>r055</i>	5th soak segment time	Sets the 5th soak segment time.	0 to 99h59m (*: 0.00)		dSP8-2	50
<i>sv-6</i>	6th target SV	Sets the 6th target SV of ramp-soak operation.	Within the SV limit. (*: 0%FS)		dSP8-4	50*
<i>r06r</i>	6th ramp segment time	Sets the 6th ramp segment time.	0 to 99h59m (*: 0.00)		dSP8-8	50
<i>r065</i>	6th soak segment time	Sets the 6th soak segment time.	0 to 99h59m (*: 0.00)		dSP8-16	50
<i>sv-7</i>	7th target SV	Sets the 7th target SV of ramp-soak operation.	Within the SV limit. (*: 0%FS)		dSP8-32	50*
<i>r07r</i>	7th ramp segment time	Sets the 7th ramp segment time.	0 to 99h59m (*: 0.00)		dSP8-64	50
<i>r075</i>	7th soak segment time	Sets the 7th soak segment time.	0 to 99h59m (*: 0.00)		dSP8-128	50
<i>sv-8</i>	8th target SV	Sets the 8th target SV of ramp-soak operation.	Within the SV limit. (*: 0%FS)		dSP9-1	50*
<i>r08r</i>	8th ramp segment time	Sets the 8th ramp segment time.	0 to 99h59m (*: 0.00)		dSP9-2	50
<i>r085</i>	8th soak segment time	Sets the 8th soak segment time.	0 to 99h59m (*: 0.00)		dSP9-4	50
<i>Mod</i>	Ramp-soak mode	Selects the power-on start, repeat, and standby functions for ramp-soak operations.	0 to 15 (*: 0)		dSP9-8	50

Note 1: When a customer does not specify the settings while ordering, the following settings are selected as factory defaults.

Thermocouple input: Thermocouple K	Measured range: 0 to 400°C
Resistance bulb input:	Measured range: 0 to 150°C
Voltage/Current input:	Scaling: 0 to 100%

Parameters of the third block

Note: The parameters for which * is marked with the page number in Reference page are related to Remedies of “4” on page 79

Parameter display symbol	Parameter name	Description	Setting range and factory default setting (*)	User's set value	Parameter mask DSP	Reference page
P-n1	Control action	Specifies control action and output at the input burn-out.	0 to 19 (*: specified by customer while ordering) Note 2		dSP9-16	53
SV-L	SV (Setting value) lower limiter	Sets the lower limit of the SV.	0 to 100%FS (*: 0%FS)		dSP9-32	54*
SV-H	SV (Setting value) upper limiter	Sets the upper limit of the SV.	0 to 100%FS (*: 100%FS)		dSP9-64	54*
dLY1	Delay time 1	Delay time or timer value for alarm 1 relay.	0 to 9999 seconds (*: 0)		dSP9-128	55
dLY2	Delay time 2	Delay time or timer value for alarm 2 relay.	0 to 9999 seconds (*: 0)		dP10-1	55
dLY3	Delay time 3	Delay time or timer value for alarm 3 relay.	0 to 9999 seconds (*: 0)		dP10-2	55
Cr	Current transe display	Displays the current detector input value for HB alarm.	-		dP10-4	57
Hb	HB (Set value of heater break alarm) setting	Sets the operation value that detects the heater break.	0 to 50.0A (Setting to 0.0A turns off the HB alarm.) (*: 0.0)		dP10-8	57
A1hY	Alarm 1 hysteresis	Sets the hysteresis range of ON and OFF of alarm 1.	0 to 50%FS (*: 1)		dP10-16	59*
A2hY	Alarm 2 hysteresis	Sets the hysteresis range of ON and OFF of alarm 2.	0 to 50%FS (*: 1)		dP10-32	59*
A3hY	Alarm 3 hysteresis	Sets the hysteresis range of ON and OFF of alarm 3.	0 to 50%FS (*: 1)		dP10-64	59*
A1oP	Alarm 1 options	Sets the optional functions of alarms 1, 2 and 3.	000 to 111 (*: 000)		dP10-128	60
A2oP	Alarm 2 options	<div style="border: 1px solid black; padding: 2px; display: inline-block;">8888</div> <ul style="list-style-type: none"> └ Alarm latch (1: use, 0: not use) └ Alarm of error status (1: use, 0: not use) └ De-energized output (1: use, 0: not use) 	000 to 111 (*: 000)		dP11-1	60
A3oP	Alarm 3 options		000 to 111 (*: 000)		dP11-2	60
PLC1	Lower limit for output 1	Sets the lower limit for output 1.	-3.0 to 103.0% (*: -3.0)		dP11-4	62
PHC1	Upper limit for output 1	Sets the upper limit for output 1.	-3.0 to 103.0% (*: 103.0)		dP11-8	62
PLC2	Lower limit for output 2	Sets the lower limit for output 2.	-3.0 to 103.0% (*: -3.0)		dP11-16	62
PHC2	Upper limit for output 2	Sets the upper limit for output 2.	-3.0 to 103.0% (*: 103.0)		dP11-32	62
PLUR	Output limit types	Sets the limit types of outputs 1 and 2 (breaking the limit, or maintained within the limit).	0 to 15 (*: 0)		dP11-64	63
oUr1	Output value (MV) display	Displays the value of output 1.	-		dP11-128	64
oUr2	Output value (MV) display	Displays the value of output 2.	-		dP12-1	64
rCJ	RCJ (Cold junction compensation) setting	Sets the cold junction compensation function to ON/OFF.	ON: Performs the RCJ (Cold junction compensation).* OFF: Does not perform the RCJ (Cold junction compensation).		dP12-2	65
GRcn	PV gradient		0.001 to 2.000 (*: 1.000)		dP12-4	
AdJ0	User-definable zero adjustment	Shifts the zero point of input value.	-50 to 50%FS (*: 0)		dP12-8	66*
AdJ5	User-definable span adjustment	Shifts the span of input value.	-50 to 50%FS (*: 0)		dP12-16	66*
dI-1	DI1 (Digital input 1) operation	Sets the DI1 operations.	0 to 12 (*: 0=OFF)		dP12-32	67
dI-2	DI2 (Digital input 2) operation	Sets the DI2 operations.	0 to 12 (*: 0=OFF)		dP12-64	67
Stno	Station No.	Sets the station No. for communication.	0 to 255 (Setting to 0 does not start the communications function.) (*: 1)		dP12-128	70
CoP	Parity setting	Sets the parity for communication. (The baud rate is fixed at 9600bps.	0: Odd parity* 1: Even parity 2: No parity		dP13-1	71

Note 2: The following settings are selected as factory defaults depending on the model you order.

Seventh digit = Y model: 0

Seventh digit = A model: 4

Note: The parameters for which * is marked with the page number in Reference page are related to Remedies of “4” on page 79.

Parameter display symbol	Parameter name	Description	Setting range and factory default setting (*)	User's set value	Parameter mask DSP	Reference page
<i>PCOL</i>	Communication protocol setting	Switches communication protocols between Modbus and ASCII	0 : Z-ASCII 1 : Modbus (RTU)		dP13-2	72
<i>Ro-r</i>	Re-transmission output type setting	Sets the type of signals to be outputted from re-transmission output.	Setting range 0 : PV / 1 : SV / 2 : MV / 3 : DV (* : 0)		dP13-4	73
<i>Ro-L</i>	Re-transmission output scaling base side setting	Re-transmission output scaling setting on the base side	Setting range -100.0 to 100.0% (*: 0.0)		dP13-4	74
<i>Ro-H</i>	Re-transmission output scaling span side setting	Re-transmission output scaling on the span side	Setting range -100.0 to 100.0% (*: 100.0)		dP13-4	74
<i>rENO</i>	Remote SV input zero adjustment	Shifts the zero point of input value.	-50 to 50%FS (*: 0)		dP13-16	75
<i>rENS</i>	Remote SV input span adjustment	Shifts the span point of input value.	-50 to 50%FS (*: 0)		dP13-16	75
<i>r-dF</i>	Remote SV input filter constant	Sets the filter constant of remote SV input value.	0.0 to 900.0 seconds (*: 0.0)		dP13-16	76
<i>rSv</i>	Remote SV input value display	Displays remote SV input value.	-		dP13-16	77
<i>dSP1</i> <i>dSP9</i> <i>dP10</i> <i>dP13</i>	Parameter mask	Sets whether or not to display each parameter.	0 to 255 (*: specified by customer while ordering)		-	78

2-2 Basic operations

Just after power-on:

The display below appears just after power-on.

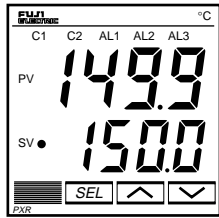

Status at delivery
<In Auto mode>

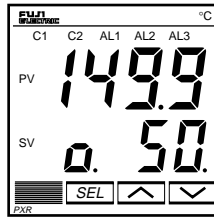

<In Manual mode>

How to switch parameters:

The figure below shows the basic operations for the PXR.

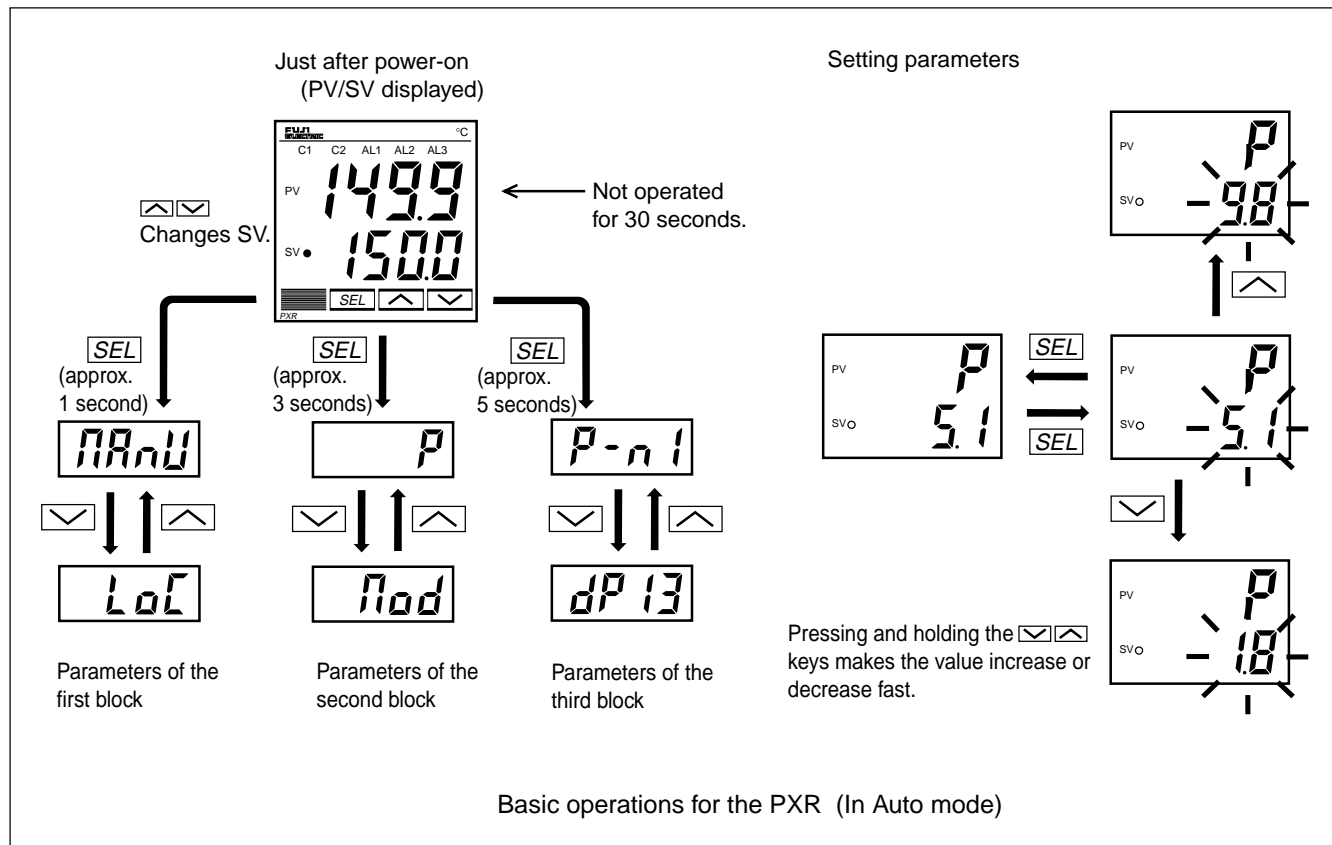

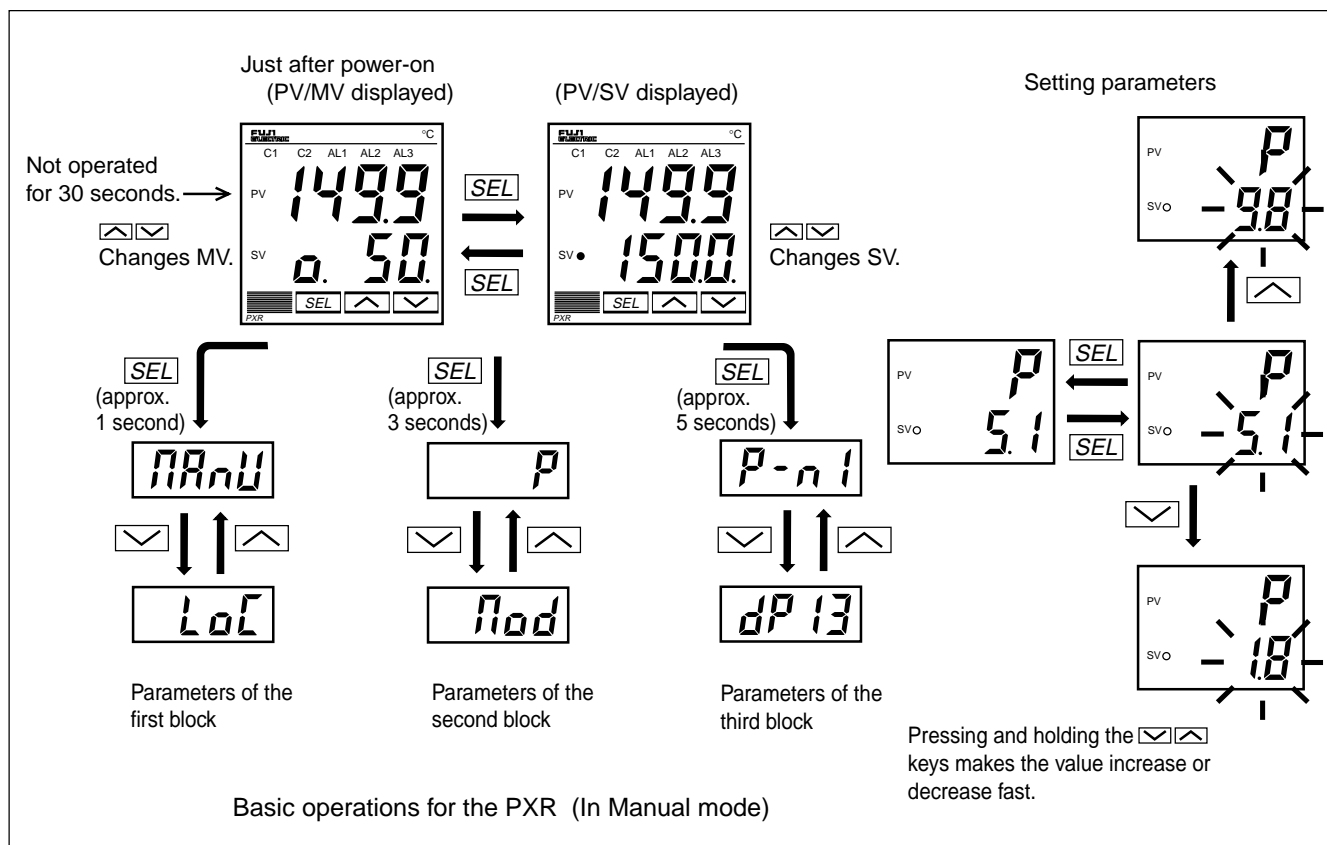

How to set values:

- [up] key: One press increases the value by 1.
Press and hold this key to increase the value fast.
- [down] key: One press decreases the value by 1.
Press and hold this key to decrease the value fast.

How to register the set data:

- By pressing the [SEL] key, the displayed values are registered.
- Note that the SV (SVO) will be registered in 3 seconds without any operation.

2-3 Parameter functions and method of settings

Method of setting the SV (Setting value)



[Description]

- The SV is a target value for control.
- Any SV that is outside of the range set in the parameters of $SV-L$ (lower limit) and $SV-H$ (upper limit) of the third block cannot be set. (See page 54.)

Related parameters: $SV-L$ (page 54)

$SV-H$ (page 54)

[Setting example] Changing the SV from 250°C to 1195°C

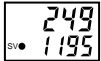
Display	Operating procedure
	1. Press the  or  keys to display <i>1195</i> .
	2. <i>1195</i> will be registered in the SV (SV0) in three seconds. After that, the controller will operate with the SV being 1195.

MANU Manual mode setting (Settings: oFF/on)

[Description]

- This parameter switches the control mode between Auto and Manual.
- During Manual operation, the decimal point is kept on at the far right in the SV display section.
- During Manual operation, auto tuning or self tuning is not done. If the mode is switched to Manual while auto or self tuning is being done, the tuning is forcibly terminated. The PID parameter remains the same in such cases.
- Manual operation output is not limited by MV limit.
- Manual operation can be carried out during standby operation.
- The operation output set value during Auto/Manual operation mode and manual mode is stored in non-volatile memory. It is kept stored even if a power interruption occurs. When the power is turned on again, the state before the power interruption is resumed.
- The following table lists the operation output at the time of switching between Auto and Manual..

Auto → Manual	Manual → Auto
Balanceless bumpless (Switches to manual mode, holding the MV value just before the switching.)	MV output according to PID operation (Sudden change may occur to the MV value.)

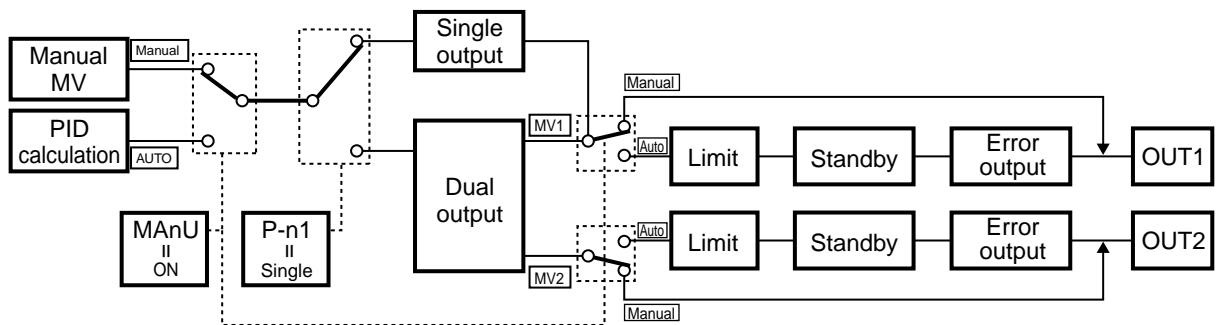

[Setting example] Switching to manual mode









Display	Operating procedure
	1. Press and hold the [SEL] key for one second, and MANU is displayed.
	2. Press the [SEL] key once, and the current set value (oFF) on the SV display section starts flickering.
	3. Press the [▲] or the [▼] keys to display oN .
	4. Press the [SEL] key once, and the manual lamp at the lower right corner comes on, indicating that the mode has been switched to Manual.
	5. To display operation status, press and hold the [SEL] key for two seconds.

Sfby Standby setting (Settings: oFF/on)

[Description]

- This parameter switches the control between RUN and Standby.
- During standby, the control output and the alarm output stay OFF, like the standby for ramp-soak operation.
- While the alarm with a hold is selected, the hold function takes effect after changing the Standby setting from ON to OFF.
- **Sfby** is displayed during the standby for ramp-soak operations or the controller changes to the standby state in case of the occurrence of errors.
- The other operations are the same as those of the ramp-soak standby.
- The setting of ON/OFF for standby is saved after power-off.
- When the standby is set to ON during the auto-tuning, self-tuning, and ramp-soak operations, those operations will stop. (The PID constant will not be renewed.) Even through it is set to OFF later, the auto-tuning, self-tuning, and ramp-soak operations will not be re-started.
- During standby, the ON-delay timer is reset. When returning to RUN from the standby state, the timer will start from the beginning.

[Setting example] Starting the control

Display	Operating procedure
     	<ol style="list-style-type: none"> 1. Press and hold the SEL key for one second. RRnU will be displayed. Then press the  key once. 2. Press the SEL key once. The current setting (oFF) flashes on the SV display. 3. Press the  or  keys to display on. 4. Press the SEL key once. The standby state for control is selected. (control output and all the alarm outputs: OFF) 5. If you want to display the operation status, press and hold the SEL key for two seconds. The value on the SV display will flash, indicating the standby status.

[Mod] Local/remote operation setting (Setting range: LoCL/rEM) (Option)

[Description]

- This parameter is used to switch between local and remote operations.









Set value	Operation
LoCL	Performs local operation.
rEM	Performs remote operation. (“rSū” and the set value (SV) are displayed alternately in the SV display section on the front face while in remote operation.)

* Local operation: Control by SV set by the keys on the front face, ramp-soak operation, SV selection determined by digital input, and SV setting via communication

* Remote operation: Control by SV determined by Remote SV input

Related parameters: *rEN0* (page 75)
rEN5 (page 75)
r-dF (page 76)
rSū (page 77)

[Setting example] Switching to remote operation

Display	Operating procedure
      	<ol style="list-style-type: none"> Press and hold the [SEL] key for one second. 5rb4 will be displayed on the PV display section. Press the  keys to display [Mod]. Press the [SEL] key once. The current setting (LoCL) in the SV display section flickers. Press the  keys to display rEM. Press the [SEL] key once. Flickering stops and the operation is switched to remote. To display the operation status, press and hold the [SEL] key for two seconds.

Prog Ramp-soak control (Settings: oFF/rUn/hLd) (Option)

[Description]



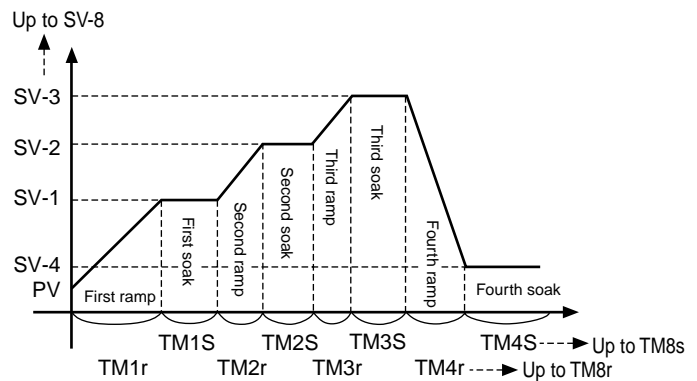



- This function automatically changes the SV (Setting value) according to the program pattern set in advance as shown in the right line graph. Up to eight pairs of ramp-soak operation can be programmed.
- The first ramp starts at the PV (Measured value) that is the one just before running the program.
- The program can also automatically run at power-on (Power-on starting function). Refer to the parameter of *Pod* (page 47).



Related parameters: *SrPr* (page 50)
Sv-1 to *Sv-8* (page 50)
Tr1r to *Tr8r* (page 50)
Tr1s to *Tr8s* (page 50)
Pod (page 50)
Pfn (page 49)

Ramp: the section in which the SV changes toward the target value.
 Soak: the section in which the SV is the target value, and remains unchanged.

[Setting example] Starting the ramp-soak operation

Display	Operating procedure
      	<ol style="list-style-type: none"> 1. Press and hold the SEL key for one second. <i>5rby</i> will be displayed on the PV display. 2. Press the <input type="checkbox"/> key to display <i>Prog</i> 3. Press the SEL key once. The current setting (<i>oFF</i>) flashes on the SV display. 4. Press the <input type="checkbox"/> or <input type="checkbox"/> keys to display <i>rUn</i>. 5. Press the SEL key once. Then, the program will start according to the ramp-soak pattern that is set in advance. 6. If you want to display the operation status, press and hold the SEL key for two seconds.

LACH Canceling the alarm latch (Setting range: 0/1) (Option)











[Description]

- This parameter cancels the alarm latch when it is latching.

Related parameters:

R1oP to *R3oP* (page 60)

[Setting example] Opening up the alarm latch

Display	Operating procedure
	<ol style="list-style-type: none"> Press and hold the SEL key for one second. <i>Srby</i> will be displayed on the PV display. Press the  key to display LACH. Press the SEL key once. The current setting (<i>0</i>) flashes on the SV display. Press the  or  keys to display <i>1</i>. Press the SEL key once. <i>1</i> will stop flashing and will change to <i>0</i> in a few seconds. If you want to display the operation status, press and hold the SEL key for two seconds.
	
	
	
	
	
	

AT Auto-tuning function (Settings: 0/1/2)

[Description]

[Note]

If the controller is powered off during auto-tuning, this makes the auto-tuning ineffective with each parameter of P , \bar{z} , and d unchanged. To start the auto-tuning operation, set AT to "1" or "2" again.

- To suspend the auto-tuning, set AT to "0". This makes the auto-tuning cancel with each parameter of P , \bar{z} , and d unchanged.
- Once the parameters of P , \bar{z} , and d are set automatically by the auto-tuning, those parameters are stored in the controller even after it is powered off. Therefore, it is not necessary to execute the auto-tuning again.
- By setting AT to "1" or "2", the auto-tuning operation starts, and at the end of the tuning, t will be displayed automatically to AT .
- After the auto-tuning operation, the controller starts to operate at the automatically set values of P , \bar{z} , and d .
- A decimal point at the right end of the SV display flashes during auto-tuning.

- There are two codes for AT:

Setting code [1]: SV standard type

Performs the auto-tuning based on the SV.

Setting code [2]: Low PV type

Performs the auto-tuning based on the SV-10%FS.

[Note]

Since ON/OFF control is performed during auto-tuning, overshoot against the SV may occur. To reduce the overshoot, execute the auto-tuning operation with the setting code [2] (Low PV) selected.

- The auto-tuning can be executed both just after power-on and in a control or stable status.

Related parameters:

P (page 24)









\bar{z} (page 25)

d (page 26)

Ar (page 30)

$LoOL$ (page 28)

[Setting example] Setting the auto-tuning operation to 1

Display	Operating procedure
	1. Press and hold the SEL key for one second. $Stby$ will be displayed on the PV display.
	
	2. Press the ▽ key to display AT .
	3. Press the SEL key once. The current setting (0) flashes on the SV display.
	4. Press the △ or ▽ keys to display t .
	
	5. Press the SEL key once. t will stop flashing and the auto-tuning will start. During auto-tuning, a decimal point at the right end of the SV display flashes.
	6. When the auto-tuning finishes properly, a decimal point stops flashing, and the set values of P , \bar{z} , and d parameters change. When the auto-tuning finishes abnormally, a decimal point stops flashing, but the set values of P , \bar{z} , and d parameters remain unchanged.
	7. If you want to display the operation status, press and hold the SEL key for two seconds.

FN-1, FN-2, FN-3 Displaying ON-delay alarm or the remaining time of timers
(unit: seconds) (Option)



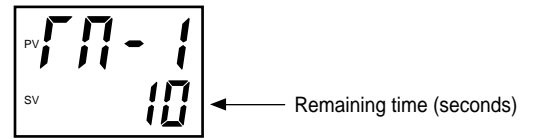

[Description]

- These parameters display the remaining time of Timers 1, 2 and 3.
- The remaining time of the ON/OFF-delay timer is counted down. When the counter shows 0, the alarm relay is closed.
- During count-down, if the PV changes to the value of the temperature at which the alarm is set to OFF, or if “DI” for the timer is set to OFF, the counter is reset, and the alarm relay is opened.

- FN-1 display parameter



[Setting example] Displaying ON-delay alarm or the remaining time of timers

Display	Operating procedure
  	<p>1. Press and hold the [SEL] key for one second. SfbY will be displayed.</p>
	<p>2. Press the [V] key to display FN-1. The remaining time of timer 1 will be displayed.</p>
	<p>3. Press the [^] or [V] keys to display the remaining time of FN-1, FN-2 and FN-3.</p>
	<p>4. If you want to display the operation status, press and hold the [SEL] key for two seconds.</p>

			Setting alarm 1, 2 and 3	} (Setting range: Absolute value alarm: 0 to 100%FS Deviation value alarm: -100 to 100%FS) (Option)
			Upper limit of alarm 1, 2 and 3	
			Lower limit of alarm 1,2 and 3	

[Description]

- These parameters are used to for settings of alarm 1, 2 and 3.
- When the alarm type (*ALN1*, *ALN2* or *ALN3*) is set to 0 to 15, alarms 1, 2 and 3 (*AL1*, *AL2* and *AL3*) can be set.
- When the alarm type (*ALN1*, *ALN2* or *ALN3*) is set to any value other than 0 to 15, the upper and lower limits of alarm 1, 2 and 3 (*A1-H*, *A2-H*, *A3-H*, *A1-L*, *A2-L*, *A3-L*) can be set.

[Note]

Setting codes (12 to 15) cannot be selected in alarm type 1 and 3 (*ALN1* / *ALN3*).

Related parameters: *ALN1*, *ALN2*, *ALN3* (page 46)
A1hY, *A2hY*, *A3hY* (page 59)
dLY1, *dLY2*, *dLY3* (page 55)
A1oP, *A2oP*, *A3oP* (page 60)

[Setting example] Setting the operation value of alarm 2 to -10°C











Display	Operating procedure
	<ol style="list-style-type: none"> 1. Press and hold the SEL key for one second. <i>Srby</i> will be displayed on the PV display. 2. Press the key to display <i>AL2</i>. 3. Press the SEL key once. The current setting (<i>10</i>) flashes on the SV display. 4. Press the or keys to display - <i>10</i>. 5. Press the SEL key once. - <i>10</i> will stop flashing and will be registered for <i>AL2</i>. After that, the controller will operate with the operation value of alarm 2 being -10°C. 6. If you want to display the operation status, press and hold the SEL key for two seconds.

LoL Key lock (Setting range: 0–5)

[Description]

- This parameter makes the set values of parameters unchangeable. However, the parameter name and the set values can be displayed.
- To reset the key lock, change to 0.
- Even when the key lock is set, control and alarm functions can operate properly.
- There are six levels of the key lock:
 - 0 : Unlocked (reset)
 - 1 : All settings are unchangeable from the controller, but changeable via communication.
 - 2 : Only the SV is changeable from the controller, and all settings are changeable via communication.
 - 3 : All settings are changeable from the controller, but unchangeable via communication.
 - 4 : All settings are unchangeable from the controller or via communication.
 - 5 : Only the SV is changeable from the controller, but all settings are unchangeable via communication.

[Setting example] Setting the key lock to “2”







Display	Operating procedure
      	<ol style="list-style-type: none"> 1. Press and hold the SEL key for one second. 5rb4 will be displayed on the PV display. 2. Press the  key to display LoL. 3. Press the SEL key once. The current setting (0) flashes on the SV display. 4. Press the  or  keys to display 2. 5. Press the SEL key once. 2 will stop flashing and will be registered for LoL. After that, any setting other than the SV cannot be changed from the front panel. 6. If you want to display the operation status, press and hold the SEL key for two seconds.

P Proportional band (Setting range: 0.0 to 999.9% of the measured range)

[Description]

- To select the ON/OFF control (two-position control), set **P** to 0.0. It is not necessary to set **L** and **d**.
- **P** can be automatically set by the auto-tuning operation.
- When **P** is too small, control will be unstable, and when **P** is too large, the response will be delayed.
- Set the hysteresis of the ON/OFF control (two-position control) in the parameter **HYS**.
- If auto-tuning is run after the ON/OFF control is selected, the ON/OFF control changes to the PID control. To keep the ON/OFF control selected, do not execute the auto-tuning.

[Setting example] Changing the proportional band from 5.0% to 15.0%















Display	Operating procedure
	<p>1. Press and hold the [SEL] key for three seconds. P will be displayed on the PV display.</p>
	
	<p>2. Press the [SEL] key once. The current setting (50) flashes on the SV display.</p>
	<p>3. Press the [▲] or [▼] keys to display 150.</p>
	<p>4. Press the [SEL] key once. 150 will stop flashing and will be registered for P. After that, the controller will operate with P being 15.0%.</p>
	<p>5. If you want to display the operation status, press and hold the [SEL] key for two seconds.</p>

 Integral time (Setting range: 0 to 3200 seconds)

[Description]

- \bar{I} can be set automatically by the auto-tuning operation.
- \bar{I} can also be set manually.
- When \bar{I} is set to 0, the integral operation does not start.
- When P is set to 0.0, this makes the setting of \bar{I} ineffective.

[Setting example] Changing the integral time from 240 seconds to 600 seconds

Display	Operating procedure
	<p>1. Press and hold the  key for three seconds. P will be displayed on the PV display.</p>
	
	<p>2. Press the  key to display \bar{I}.</p>
	<p>3. Press the  key once. The current setting (240) flashes on the SV display.</p>
	<p>4. Press the  or  keys to display 600.</p>
	<p>5. Press the  key once. 600 will stop flashing and will be registered for \bar{I}. After that, the controller will operate with \bar{I} being 600 seconds.</p>
	<p>6. If you want to display the operation status, press and hold the  key for two seconds.</p>



Derivative time (Setting range: 0.0 to 999.9 seconds)

[Description]

- d can be set automatically by the auto-tuning operation.
- d can also be set manually.
- When d is set to 0, the differential operation does not start.
- When P is set to 0.0, this makes the setting of d ineffective.

[Setting example] Changing the differential time from 60.0 seconds to 50.0 seconds

Display	Operating procedure
	<ol style="list-style-type: none"> 1. Press and hold the [SEL] key for three seconds. P will be displayed on the PV display. 2. Press the [V] key to display d. 3. Press the [SEL] key once. The current setting (600) flashes on the SV display. 4. Press the [^] or [v] keys to display 500. 5. Press the [SEL] key once. 500 will stop flashing and will be registered for d. After that, the controller will operate with d being 50.0 seconds. 6. If you want to display the operation status, press and hold the [SEL] key for two seconds.

HYS Hysteresis range for ON/OFF control (Setting range: 0 to 50%FS)

[Description]







- To select the ON/OFF control (two-position control), set P to 0.0. It is not necessary to set \bar{L} and d .
- When the hysteresis range (Range of ON/OFF control) is too small, the output may switch the ON/OFF frequently. (This may affect the life of the device to be controlled, especially when contact output is selected.)
- The unit of the set value of this parameter is °C or °F (engineering unit). The setting range varies according to the measured range of input.

[Ex] Input Thermocouple K : At measured range of 0 to 400 °C, the setting range is 0 to 200 °C.

Resistance bulb : At measured range of 0 to 150 °C, the setting range is 0 to 75 °C.

Related parameters: P (page 24)
 $ONOFF$ (page 36)

[Setting example] Changing the hysteresis range from 1°C to 35°C

Display	Operating procedure
      	<ol style="list-style-type: none"> 1. Press and hold the [SEL] key for three seconds. P will be displayed on the PV display. 2. Press the [V] key to display HYS. 3. Press the [SEL] key once. The current setting (1) flashes on the SV display. 4. Press the [^] or [v] keys to display 35 . 5. Press the [SEL] key once. 35 will stop flashing and will be registered for HYS . After that, the controller will operate with the hysteresis range being 35°C. 6. If you want to display the operation status, press and hold the [SEL] key for two seconds.

COOL

Cooling-side proportional band coefficient (Option: Available for DUAL output only) (Setting range: 0.0 to 100.0)

[Description]

- This parameter is used for setting the cooling-side proportional band. (See the figure below.)

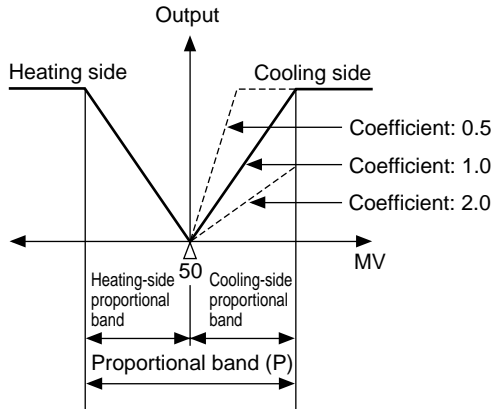

- Before setting the cooling-side proportional band, set the heating-side proportional band to an optimum value. To select the two-position control for the cooling side, set **COOL** to 0.0.

$$\text{Cooling-side proportional band} = \frac{\text{Proportional band (P)}}{2} \times \text{Coefficient}$$

Ex) When making the proportional band of 10% of the full scale with the proportional band (P) being 50%:

$$10\% = \frac{50\%}{2} \times \text{Coefficient}$$

Consequently, the coefficient is 0.4.

- When **P** is set to 0.0 and **COOL** is set to 0.0 in the dual output type, the cooling output is as shown in the figure below. The hysteresis is fixed at 0.5% FS.

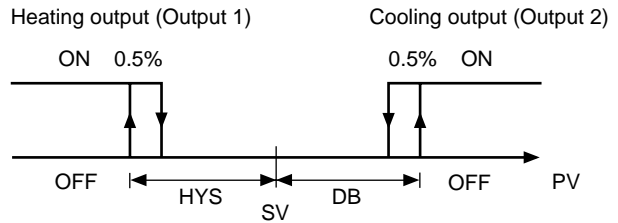

Related parameters: **HYS** (page 27)
P (page 24)
db (page 29)

[Setting example] Changing the cooling-side proportional band coefficient from 1.0 to 2.5

Display	Operating procedure
 	<ol style="list-style-type: none"> Press and hold the SEL key for three seconds. P will be displayed on the PV display.
	<ol style="list-style-type: none"> Press the DOWN key to display COOL.
	<ol style="list-style-type: none"> Press the SEL key once. The current setting (10) flashes on the SV display.
	<ol style="list-style-type: none"> Press the UP or DOWN keys to display 25.
	<ol style="list-style-type: none"> Press the SEL key once. 25 will stop flashing and will be registered for COOL. After that, the controller will operate with the cooling-side proportional band coefficient being 2.5.
	<ol style="list-style-type: none"> If you want to display the operation status, press and hold the SEL key for two seconds.

db

Cooling-side proportional band shift (Dead band/Overlap band)

(Option: Available for DUAL output only) (Setting range: -50.0 to +50.0)

[Description]

- This parameter is used for shifting the cooling-side proportional band from the set value. (See the figure below.)

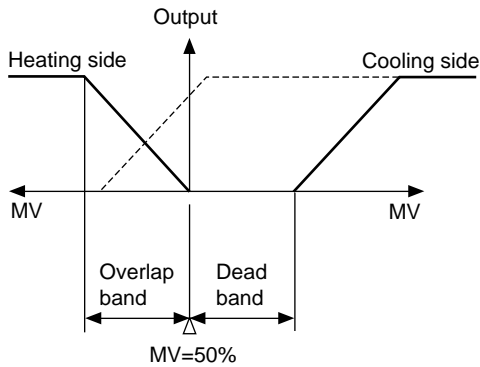

- When **db** is a positive value, it is called the “Dead band”, and when it is a negative value, the “Overlap band”.
- Since the unit of **db** is same one used for MV [%], if you want to set **db** in the unit of deviation [%], **db** must be converted using the equation below.

$$DB [\%] = \text{Deviation} \times \frac{100}{P} [\%]$$

Ex) When making a dead band with a deviation of 1.0 [%] from the SV while the proportional band (P) is 5.0%:

$$DB [\%] = 1.0 \times \frac{100}{5.0} = 20 [\%]$$

Consequently, set the parameter **db** to 20 [%].

- Related parameters: **P** (page 24)

[Setting example] Shifting the cooling-side proportional band by 2.0

Display	Operating procedure
	<ol style="list-style-type: none"> Press and hold the [SEL] key for three seconds. P will be displayed on the PV display. Press the [V] key to display db. Press the [SEL] key once. The current setting (00) flashes on the SV display. Press the [^] or [v] keys to display 20. Press the [SEL] key once. 20 will stop flashing and will be registered for db. After that, the controller will operate with db being 2.0 %. If you want to display the operation status, press and hold the [SEL] key for two seconds.

bAL Output offset value (Setting range: -100.0 to 100.0 %)

Ar Anti-reset windup (Setting range: 0 to 100%FS)

[Description]







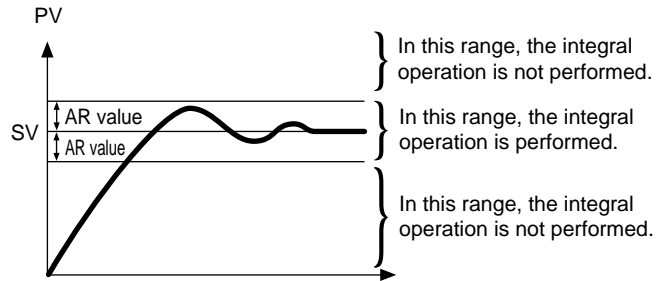



- The anti-reset windup (**Ar**) is automatically set to an optimum value by the auto-tuning operation.
By setting **bAL**, the amount of overshoot can be adjusted.

[Note]

By making use of the fuzzy control system equipped with PXR, the amount of overshoot can be minimized without setting **bAL** and **Ar**.



[Setting example] Changing the anti-reset windup from 60°C to 80°C.







Display	Operating procedure
	<ol style="list-style-type: none"> Press and hold the SEL key for three seconds. P will be displayed on the PV display. Press the  key to display Ar. Press the SEL key once. The current setting (60) flashes on the SV display. Press the  or  keys to display 80. Press the SEL key once. 80 will stop flashing and will be registered for Ar. After that, the controller will operate with the anti-reset windup being 80°C. If you want to display the operation status, press and hold the SEL key for two seconds.
	
	
	
	
	
	

[FRL] Control algorithm (Settings: PID/FUZY/SELF)

[Description]

- This parameter is used for selecting PID control, FUZZY-PID control, or PID control with self-tuning.
- To select the PID control or FUZZY-PID control, it is necessary to set the parameters of P , I , d , and Rr manually or by the auto-tuning in advance.
- For the ON/OFF control (Two-position control), select the PID control and then set P to 0.0. For detailed information, refer to P (page 24).
- Refer to the next page for the PID control with self-tuning.

[Setting example] Changing the control system from PID to FUZZY

Display	Operating procedure
	<ol style="list-style-type: none"> 1. Press and hold the [SEL] key for three seconds. P will be displayed on the PV display. 2. Press the [V] key to display [FRL]. 3. Press the [SEL] key once. The current setting (PId) flashes on the SV display. 4. Press the [^] or [v] keys to display FUZY. 5. Press the [SEL] key once. FUZY will stop flashing and will be registered for [FRL]. After that, the controller will operate with the FUZZY control system activated. 6. If you want to display the operation status, press and hold the [SEL] key for two seconds.
	
	
	
	
	
	

[Self-tuning]

1 Function:

With the self-tuning function, PID parameters are automatically re-optimised depending on the actual condition of device to be controlled and the setting temperature (SV).

2 How to execute:

Follow the procedure shown below to set and execute the self-tuning. The self-tuning starts to run at the appropriate conditions. (See page 31)

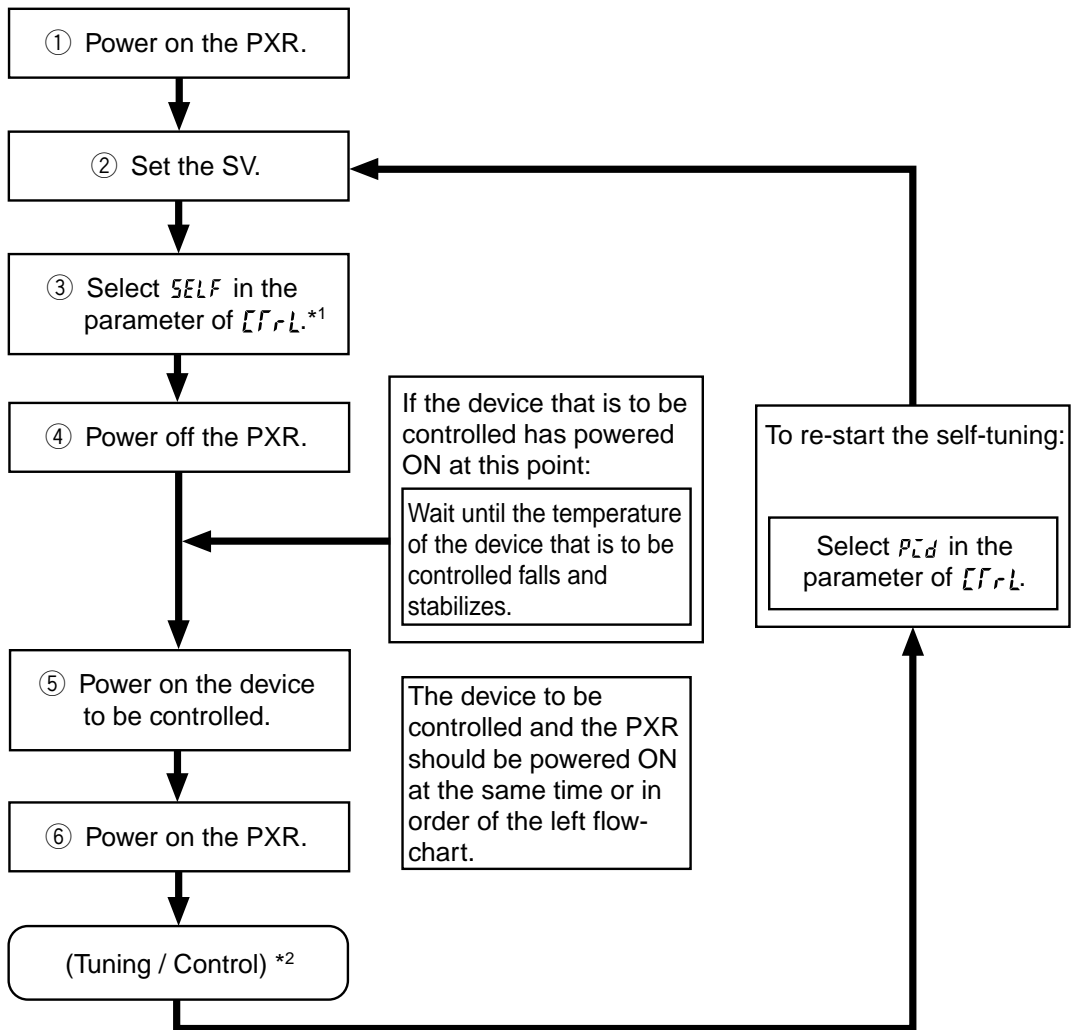

*1: How to set the parameter of CFrL:



*2: Display during self-tuning is shown below:

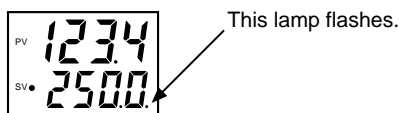

3 Conditions under which the self-tuning runs:

① At power-on:

The self-tuning runs when all of the following conditions are met.

- The SV that appears at power-on is not the same one when the P , \bar{I} , d , and R_r were set previously. (i.e. the P , \bar{I} , d , and R_r set by the self-tuning, auto-tuning, manual setting, and writing by communications tools at previous time)
- The (SV-PV) at power-on is larger than (the value of $P \times$ input range) or (the set value of $SLFb$).

② When the SV is changed:

The self-tuning runs when all the conditions below are met.

- The changed SV is larger than the SV that was set when the P , \bar{I} , d , and R_r were selected previously.
- The changed amount of the SV is larger than 0.
- The changed amount of the SV is larger than (the set value of $P \times$ input range) or (the set value of $SLFb$).

③ When output becomes unstable:

The self-tuning runs when control becomes unstable and the hunting of the operating output (MV) occurs. (The self-tuning runs only once as long as the SV is not changed.)

④ When the control standby mode is cancelled:

The self-tuning runs by the same reason as “① At power-on” are met.

* Only when the PXR is set to standby mode at power-on.

4 Conditions under which the self-tuning does not run:

- ① During control standby mode
- ② During two-position control (Parameter of $P = 0$)
- ③ During auto-tuning operation
- ④ During ramp-soak operation
- ⑤ Error display ($LLLL$ or $UUUU$ is displayed.)
- ⑥ During dual output (The set value of the parameter of $P-n$ l is larger than 4.)
- ⑦ When setting the parameters of P , \bar{I} , d , and R_r manually (including the setting written by communications tools)

5 Conditions under which the self-tuning is suspended:

- ① At the condition described in **4** shown above
- ② When the SV is changed during self-tuning operation
- ③ When the self-tuning operation can not be completed within approx. 9 hours

6 Caution

- ① Once the PID constant is set, the self-tuning does not operate at next power-on as long as the SV is not changed.
- ② For an accurate tuning, be sure to power on the device to be controlled before or at the same time as the PXR is powered on. If the PXR has to be powered on first for reasons of the system configuration, perform the auto-tuning with the PID or FUZZY control.
- ③ If the device to be controlled is powered on under temperature change (especially when it rises), accurate tunings can not be performed. Be sure to power on the PYX when the temperature of device to be controlled is stabilized.
- ④ The self-tuning does not run for cooling system control under Direct Action output (Parameter $P-n$ $l = 2$ or 3).
- ⑤ In case the control is not stable after performing the self-tuning, change the algorithm to the PID or FUZZY control and perform the auto-tuning.

7 Reference [About the self-tuning method]

The PID constant is calculated in one of the following two methods.

The method is selected automatically depending on the characteristics of the device to be controlled.

- Step response method
- Limit cycle method

The following figures show the operations at power-on and changing the SV, and under unstable control.

① Operations at power-on

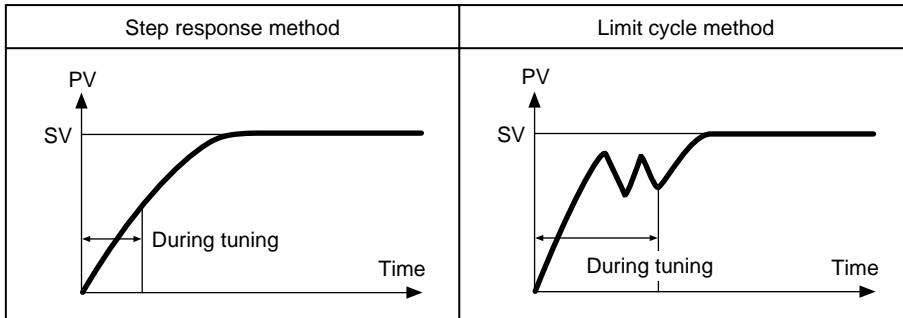

② Operations at changing the SV

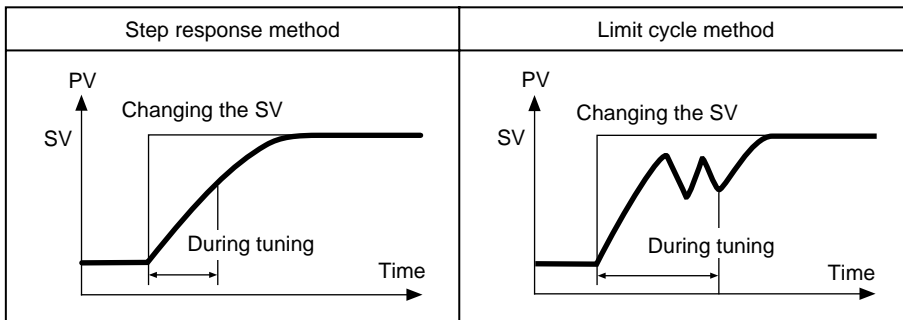

③ Operation under unstable control

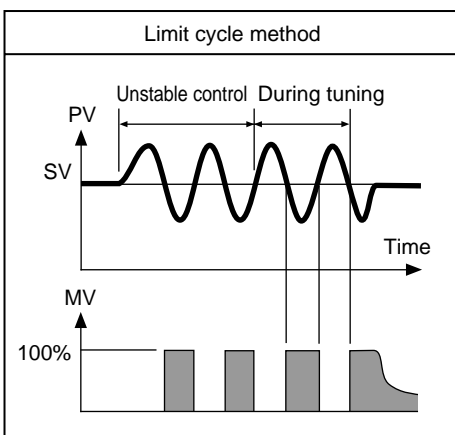











SLFb PV (Measured value) stable range (Setting range: 0 to 100%FS)

[Description]

- Self-tuning logic recognizes that control is stable if PV is staying within the $SV \pm SLFb$.
- It is not necessary to set this parameter under normal conditions.

[Setting example] Changing the PV stable range from 2 to 3

Display	Operating procedure
	<p>1. Press and hold the SEL key for three seconds. P will be displayed on the PV display.</p>
	
	<p>2. Press the  key to display SLFb.</p>
	<p>3. Press the SEL key once. The current setting (2) flashes on the SV display.</p>
	<p>4. Press the  or  keys to display 3.</p>
	<p>5. Press the SEL key once. 3 will stop flashing and will be registered for SLFb. After that, the controller will operate with the PV range being 3.</p>
	
	<p>6. If you want to display the operation status, press and hold the SEL key for two seconds.</p>



HYS (Hysteresis) mode at ON/OFF control (Settings: oFF/on)

[Description]

- This parameter is used for selecting the hysteresis operation mode at ON/OFF control.

oFF: Starts the ON/OFF control at the values of $SV + \frac{HYS}{2}$ and $SV - \frac{HYS}{2}$.

on: Starts the ON/OFF control at the values of SV and SV+HYS, or SV and SV-HYS.

- Default setting: ON

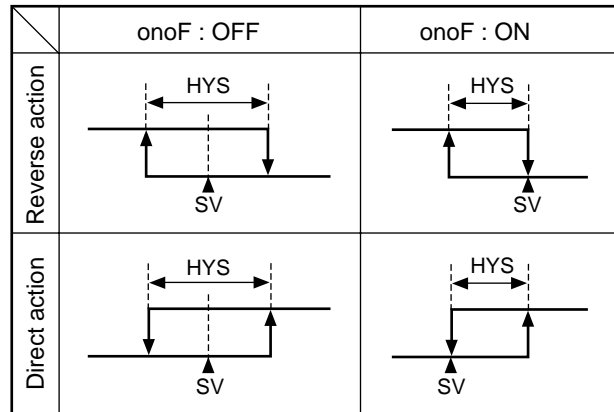

[Setting example] Setting the hysteresis mode to ON

Display	Operating procedure
 	<ol style="list-style-type: none"> Press and hold the [SEL] key for three seconds. P will be displayed on the PV display.
	<ol style="list-style-type: none"> Press the [V] key to display onoF.
	<ol style="list-style-type: none"> Press the [SEL] key once. The current setting (oFF) flashes on the SV display.
 	<ol style="list-style-type: none"> Press the [V] key to display on. Press the [SEL] key once. on will stop flashing and will be registered for onoF. After that, the controller will operate with the hysteresis being as shown in the figure of ON above.
	<ol style="list-style-type: none"> If you want to display the operation status, press and hold the [SEL] key for two seconds.



Cycle time of control output 1 (Setting range: 1 to 150 seconds)

[Description]

- This parameter is applicable for to the contact output and SSR-driving output.
- While input is within the proportional band, output changes between ON and OFF in cycles. These cycles are called cycle time.

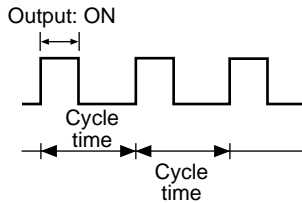

- Do not set this parameter to "0".

For contact output:

The higher the frequency of output is, the more precise the control becomes. However a high frequency of output may shorten the life of the contacts and the device to be controlled. Be sure to adjust the proportional cycles considering controllability and the life of the device and the contacts.

Typical: 30 seconds

For SSR-driving output:

Use in short cycles if there is no problem with the device to be controlled.

Typical: 1 to 2 seconds

[Setting example] Setting the cycle time from 30 seconds to 20 seconds

Display	Operating procedure
	<ol style="list-style-type: none"> 1. Press and hold the [SEL] key for three seconds. P will be displayed on the PV display. 2. Press the [∇] key to display FC. 3. Press the [SEL] key once. The current setting (30) flashes on the SV display. 4. Press the [▲] or [∇] key to display 20. 5. Press the [SEL] key once. 20 will stop flashing and will be registered for FC. After that, the controller will operate with the cycle time being 20 seconds. 6. If you want to display the operation status, press and hold the [SEL] key for two seconds.



Cycle time of control output 2 (Cooling-side)

(Setting range: 1 to 150 seconds) (Option: Available for DUAL output only)

[Description]

- By this parameter is set, the cycle time of control output 2.
- While input is within the proportional band, output changes between ON and OFF in cycles. These cycles are called cycle time.

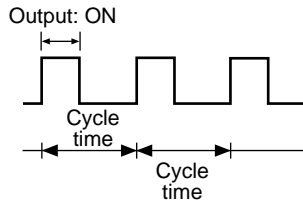

- Do not set this parameter to "0".

For contact output:

The higher the frequency of output is, the more precise the control becomes. However a high frequency of output may shorten the life of the contacts and the device to be controlled. Be sure to adjust the proportional cycles considering controllability and the life of the device and the contacts.

Typical: 30 seconds

[Setting example] Setting the cooling-side cycle time from 30 seconds to 20 seconds

Display	Operating procedure
	<ol style="list-style-type: none"> 1. Press and hold the SEL key for three seconds. P will be displayed on the PV display. 2. Press the key to display rC2. 3. Press the SEL key once. The current setting (30) flashes on the SV display. 4. Press the or key to display 20. 5. Press the SEL key once. 20 will stop flashing and will be registered for rC2. After that, the controller will operate with the cooling-side cycle time being 20 seconds. 6. If you want to display the operation status, press and hold the SEL key for two seconds.

$P-n2$ Input signal code (Setting range: 0 to 16)

[Description]

- This parameter is used for selecting input signals. Input signal varies depending on the sensors (2 types below).

Set a code that corresponds to the sensor you use.

Type I : Thermocouples (9 kinds of signals)
Resistance bulbs (1 kind of signal)

Type II : Voltage, current

- Input signals can be selected within the same type. It is impossible to select input signals of a different type.
- For type II, to change from the voltage input to the current input, connect the supplied resistance of 250Ω between terminals ⑰ and ⑱ (in the case of PXR4), and between terminals ⑳ and ㉑ (in the case of PXR5/9), in addition to changing the code.

When changing from the current input to the voltage input, remove the resistance of 250Ω as well as changing the code.

- Input signals and codes











① Input signals code table

Type	Input signal	Code $P-n2$
I	Resistance bulb (RTD)	1
	• Pt 100	
	Thermocouple	2 3 4 5 6 7 8 12 13
	• J	
	• K	
	• R	
	• B	
	• S	
	• T	
	• E	
• N		
• PL-II		
II	1 to 5 V, 4 to 20mA DC	16

[Note]

After changing the codes, power off the PXR, and then power it on again.

[Setting example] Changing from thermocouple K to thermocouple T in Type I

Display	Operating procedure
      	<ol style="list-style-type: none"> Press and hold the SEL key for three seconds. P will be displayed on the PV display. Press the  key to display $P-n2$. Press the SEL key once. The current setting (3) flashes on the SV display. Press the  or  key to display 7. Press the SEL key once. 7 will stop flashing and will be registered for $P-n2$. After that, the controller will operate with the kind of input signals being thermocouple T. If you want to display the operation status, press and hold the SEL key for two seconds.

P-5L Setting the measuring range (Input range) (Setting range: -1999 to 9999)

P-5U

P-F Selection °C / °F (Settings: °C / °F)

[Description]

- These parameters are used for setting the lower and upper limits of the measured range and unit of temperature.
- A decimal point position can be set in the parameter of **P-dP**.
- For the current and voltage inputs, **0**, **1** and **2** can be set for **P-dP**, and for other inputs, **0** and **1** can be set for **P-dP**.
- See the right table for input range.

② Input range table (Standard range)

Input type		Range (°C)	With / without a decimal point (°C)*	Range (°F)	With / without a decimal point (°F)*
Resistance bulb JIS (IEC)	Pt100Ω	0 to 150	O	32 to 302	O
		0 to 300	O	32 to 572	O
		0 to 500	O	32 to 932	O
		0 to 600	O	32 to 1112	X
		-50 to 100	O	-58 to 212	O
		-100 to 200	O	-148 to 392	O
		-199 to 600	O	-328 to 1112	X
Thermocouple	J J K K K R B S T T E E N PL-II	0 to 400	O	32 to 752	O
		0 to 800	O	32 to 1472	X
		0 to 400	O	32 to 752	O
		0 to 800	O	32 to 1472	X
		0 to 1200	X	32 to 2192	X
		0 to 1600	X	32 to 2912	X
		0 to 1800	X	32 to 3272	X
		0 to 1600	X	32 to 2912	X
		-150 to 200	O	-238 to 392	X
		-150 to 400	O	-238 to 752	X
		0 to 800	O	32 to 1472	X
		-150 to 800	O	-238 to 1472	X
		0 to 1300	X	32 to 2372	X
0 to 1300	X	32 to 2372	X		
Direct-current voltage	1 to 5 V DC	-1999 to 9999 (Scaling is possible)			

* O: with
X: without

* For 4 to 20mA DC input, connect the supplied resistance of 250Ω between terminals ⑰ and ⑱ (in the case of PXR4), and between terminals ⑳ and ㉑ (in the case of PXR5/9) to change to the 1 to 5V DC input.

















[Note]

The input accuracy is ±0.5%FS±1 digit except the cases shown below.

Thermocouple R at 0 to 500 °C: } In this range, this controller may display a wrong process value because of the characteristics of the sensor.
Thermocouple B at 0 to 400 °C: }

Other kinds of thermocouples: ±0.5% FS ± 1 digit ± 1 °C

[Setting example] Changing the measuring range from 0°C to 150°C to -100°C to 200°C (Pt100) —

Display	Operating procedure
	<p>1. Press and hold the SEL key for three seconds. <i>P</i> will be displayed on the PV display.</p>
	
	<p>2. Press the  key to display <i>P-5L</i>.</p>
	<p>3. Press the SEL key once. The current setting (<i>0</i>) flashes on the SV display.</p>
	<p>4. Press the  or  key to display <i>-100</i>.</p>
	<p>5. Press the SEL key once. <i>-100</i> will stop flashing and will be registered for <i>P-5L</i>.</p>
	<p>6. Press the  key to display <i>P-5U</i> on the PV display.</p>
	<p>7. Press the SEL key once. The current setting (<i>150</i>) flashes on the SV display.</p>
	<p>8. Press the  or  key to display <i>200</i>.</p>
	<p>9. Press the SEL key once. <i>200</i> will be registered for <i>P-5U</i>. After that, the controller will operate with the measured range being -100°C to 200°C.</p>
	<p>10. If you want to display the operation status, press and hold the SEL key for two seconds.</p>

P-dP Decimal point position (Settings: 0 / 1 / 2)

[Description]

- This parameter is used for selecting the number of decimal point positions for the PV (Measured value).

Related parameters: **P-SL** (page 40)
P-SU (page 40)



- "0" (No digit after decimal point)
- "1" (1 digit after decimal point)
- "2" (2 digit after decimal point. This is valid only for the voltage and current inputs)

[Setting example] Changing the decimal point position setting from 0 to 1







Display	Operating procedure
 	<p>1. Press and hold the SEL key for three seconds. P will be displayed on the PV display.</p>
	<p>2. Press the key to display P-dP.</p>
	<p>3. Press the SEL key once. The current setting (0) flashes on the SV display.</p>
	<p>4. Press the key to display 1.</p>
	<p>5. Press the SEL key once. 1 will stop flashing and will be registered for P-dP. After that, the controller will operate with one decimal point position displayed.</p>
	<p>6. If you want to display the operation status, press and hold the SEL key for two seconds.</p>

PVDF PV (Measured value) offset (Setting range: -10 to 10%FS)

[Description]

- With this function, predetermined value is added to the input reading. This parameter is used for adjusting PXR's indication so that it becomes same as the one of the other instruments like recorder.
- The PXR operates at the displayed PV (the value to which the PV offset value is added).

[Setting example] Adding the PV offset value of 5°C to the input value of 1200 °C











Display	Operating procedure
	<p>1. Press and hold the [SEL] key for three seconds. <i>p</i> will be displayed on the PV display.</p> <p>2. Press the [V] key to display <i>PVDF</i>.</p> <p>3. Press the [SEL] key once. The current setting (<i>0</i>) flashes on the SV display.</p> <p>4. Press the [^] or [v] key to display <i>5</i>.</p> <p>5. Press the [SEL] key once. <i>5</i> will stop flashing and will be registered for <i>PVDF</i>. After that, the controller will operate so that the value to which the offset value of 5°C is added can be brought close to the set value.</p> <p>6. If you want to display the operation status, press and hold the [SEL] key for two seconds.</p>
	
	
	
	
	
	

SVDF SV (Setting value) offset (Setting range: -50 to 50%FS)

[Description]

- With this function, predetermined value is added to the original SV. This parameter is used to eliminate the offset that occurs in performing P control.
- The PXR operates based on the SV to which the SV offset value is added.
- Alarm judgment is made by the displayed SV to which the SV offset value is not added.

[Setting example] Adding the SV offset value of 9°C to the currently set value

Display	Operating procedure
 	<p>1. Press and hold the SEL key for three seconds. <i>p</i> will be displayed on the PV display.</p>
	<p>2. Press the  key to display SVDF.</p>
	<p>3. Press the SEL key once. The current setting (<i>0</i>) flashes on the SV display.</p>
	<p>4. Press the  or  key to display <i>9</i>.</p>
	<p>5. Press the SEL key once. <i>9</i> will stop flashing and will be registered for SVDF. (The displayed SV remains unchanged.) After that, the controller will operate at the SV value to which the SV offset value of 9°C is added.</p>
	<p>6. If you want to display the operation status, press and hold the SEL key for two seconds.</p>

P-dF Time constant of input filter (Setting range: 0.0 to 900.0 seconds)

[Description]

- This parameter are used for reducing the fluctuation of input signal (filter function).

For example, when the input filter constant is set to 5 seconds, the PV changes as shown in right figure while input changes from 0 to 100% suddenly. It takes 5 seconds for the PV to change from 0 to 63.2%.

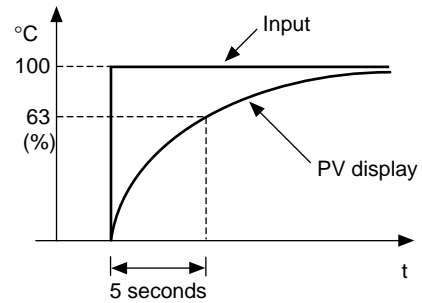
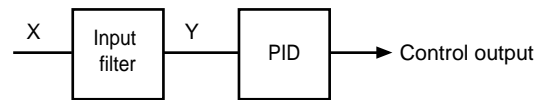

[Note]

The factory default setting is 5.0 (5 seconds). Do not change this parameter as long as changing is not of absolute necessity.

[Setting example] Changing the filter constant from 5.0 (5 seconds) to 10.0 (10 seconds)

Display	Operating procedure
	<ol style="list-style-type: none"> Press and hold the SEL key for three seconds. p will be displayed on the PV display. Press the key to display P-dF. Press the SEL key once. The current setting (50) flashes on the SV display. Press the or key to display 100. Press the SEL key once. 100 will stop flashing and will be registered for P-dF. After that, the controller will operate with the filter constant being 10.0. If you want to display the operation status, press and hold the SEL key for two seconds.

ALN1, **ALN2**, **ALN3** Alarm types (Setting range: 0 to 34) (Option)

[Description]

- These parameters are used for selecting the operation types of Alarms 1, 2 and 3.
- **ALN1** or **ALN3** is activated in the same way as **ALN2** except for codes 12 to 15. (Codes 12 to 15 cannot be selected for **ALN1** and **ALN3**.)
- When any code of 12 to 15 is selected for Alarm 2, Alarm 2 is activated and Alarm 1 or Alarm 3 is cancelled. “Alarm hysteresis”, “Delay time”, and “Alarm latch” can be selected in Alarm 2 settings.
- The display of the parameter in which the alarm value is set varies depending on the alarm operation types.

[Note]

- Since the alarm set value may change after changing the alarm operation types, be sure to set the alarm set value again.
- After changing the alarm operation types, power the PXR off, and then on.
- Setting code 0 indicates “No alarm”.

Related parameters: **R1hY**, **R2hY**, **R3hY** (page 59)
R1oP, **R2oP**, **R3oP** (page 60)
AL1, **AL2**, **AL3** (page 22)
dLY1, **dLY2**, **dLY3** (page 55)

[Note] Alarm set value and alarm operations

		Alarm set value (AL)	
		Plus setting	Minus setting
Absolute value	Upper limit		Disabled
	Lower limit		Disabled
Deviation value	Upper limit		
	Lower limit		

[Setting example] Changing the alarm type of Alarm 2 from upper-limit deviation to the upper-limit deviation with hold

Display	Operating procedure
	<ol style="list-style-type: none"> 1. Press and hold the [SEL] key for three seconds. <i>p</i> will be displayed on the PV display. 2. Press the [V] key to display ALN2. 3. Press the [SEL] key once. The current setting (5) flashes on the SV display. 4. Press the [<] key to display 8. 5. Press the [SEL] key once. 8 will stop flashing and will be registered for ALN2. After that, the controller will operate with Alarm 2 of upper limit deviation with hold. 6. If you want to display the operation status, press and hold the [SEL] key for two seconds.

[Alarm type list]

The table below shows the meaning of symbols in the following operation figures.

Alarm type	Alarm 1		Alarm 2		Alarm 3	
	Display symbol	Screen name	Display symbol	Screen name	Display symbol	Screen name
0 to 15	AL1	Set value of Alarm 1	AL2	Set value of Alarm 2	AL3	Set value of Alarm 3
16 to 31	A1-L	Lower-limit of set value of Alarm 1	A2-L	Lower-limit of set value of Alarm 2	A3-L	Lower-limit of set value of Alarm 3
	A1-H	Upper-limit of set value of Alarm 1	A2-H	Upper-limit of set value of Alarm 2	A3-H	Upper-limit of set value of Alarm 3

- Alarm 1 and 3 are activated in the same way as alarm 2 except codes 12 to 15. (Codes 12 to 15 cannot be selected for Alarm 1 or 3. If any of them is selected, the instrument recognizes it as code 0, “No alarm,” and operates as such.)
- When any code of 12 to 15 is selected for Alarm 2, Alarm 2 is activated and Alarm 1 is not raised. “Alarm hysteresis”, “Delay time”, and “Alarm latch” can be selected in Alarm 2 settings.
- The display of the parameter in which the alarm value is set varies depending on the alarm operation types.
- Since the alarm set value may change after changing the alarm operation types, confirm the alarm set value. (Note that this is not abnormal.)

• Alarm codes for standard types

	ALM1	ALM2	ALM3	Alarm type	Operation figure
	0	0	0	No alarm	
Absolute value alarm	1	1	1	Upper-limit absolute value	
	2	2	2	Lower-limit absolute value	
	3	3	3	Upper-limit absolute value (with hold)	
	4	4	4	Lower-limit absolute value (with hold)	
Deviation value alarm	5	5	5	Upper-limit deviation	
	6	6	6	Lower-limit deviation	
	7	7	7	Upper and lower limits deviation	
	8	8	8	Upper-limit deviation (with hold)	
	9	9	9	Lower-limit deviation (with hold)	
	10	10	10	Upper and lower limits deviation (with hold)	

	ALM1	ALM2	ALM3	Alarm type	Operation figure
Range alarm	11	11	11	Range upper and lower limits deviation (ALM1/2 independent operation)	
	-	12	-	Range upper and lower limits absolute value	
	-	13	-	Range upper and lower limits deviation	
	-	14	-	Range upper limit absolute value and lower limit deviation	
	-	15	-	Range upper limit deviation and lower limit absolute value	

• Timer codes

	ALM1	ALM2	ALM3	Alarm type	Operation figure
Timer	32	32	32	ON-delay timer	
	33	33	33	OFF-delay timer	
	34	34	34	ON/OFF-delay timer	

• Alarm codes with dual set values

	ALM1	ALM2	ALM3	Alarm type	Operation figure
Upper and lower limits alarm	16	16	16	Upper and lower limits absolute value	
	17	17	17	Upper and lower limits deviation	
	18	18	18	Upper limit absolute value and lower limit deviation	
	19	19	19	Upper limit deviation and lower limit absolute value	
	20	20	20	Upper and lower limits absolute value (with hold)	
	21	21	21	Upper and lower limit deviation (with hold)	
	22	22	22	Upper limit absolute value and lower limit deviation (with hold)	
	23	23	23	Upper limit deviation and lower limit absolute value (with hold)	

	ALM1	ALM2	ALM3	Alarm type	Operation figure
Range alarm	24	24	24	Range upper and lower limits absolute value	
	25	25	25	Range upper and lower limits deviation	
	26	26	26	Range upper limit absolute value and lower limit deviation	
	27	27	27	Range upper limit deviation and lower limit absolute value	
	28	28	28	Range upper and lower limits absolute value (with hold)	
	29	29	29	Range upper and lower limits deviation (with hold)	
	30	30	30	Range upper limit absolute value and lower limit deviation (with hold)	
	31	31	31	Range upper limit deviation and lower limit absolute value (with hold)	

dLYn: The delay time of Alarms 1, 2 and 3 or timers 1, 2 and 3

ALn: The set value of Alarms 1, 2 and 3

An-L: The set value (lower limit) of Alarms 1, 2 and 3

An-H: The set value (upper limit) of Alarms 1, 2 and 3

AL1: The set value of Alarm 1

AL2: The set value of Alarm 2

AL3: The set value of Alarm 3

PFn Selecting ramp-soak patterns (Settings: 1 / 2 / 3) (Option)

[Description]

- This parameter becomes effective when the ramp-soak operation is changed from *OFF* to *RUN*.
- Setting range
 - 1 : Performs 1st to 4th segments.
 - 2 : Performs 5th to 8th segments.
 - 3 : Performs 1st to 8th segments.

[Note]

- This parameter is not effective if it is changed during RUN or HOLD.
- Types 1 and 2 cannot run one after another.
- Once *SV-1* to *SV-8* are set, when the SV limiter is set the set values of *SV-1* to *SV-8* are not changed, but the SV displayed during ramp-soak operation is affected by the SV limiter.

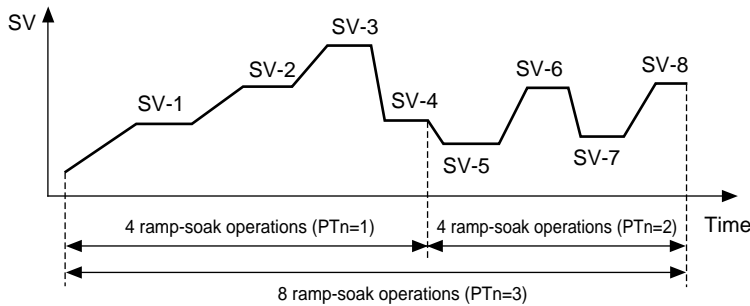

[Setting example] Changing the ramp-soak execute type from 1 to 3

Display	Operating procedure
	<ol style="list-style-type: none"> 1. Press and hold the SEL key for three seconds. <i>p</i> will be displayed on the PV display. 2. Press the ∇ key to display <i>PFn</i>. 3. Press the SEL key once. The current setting (1) flashes on the SV display. 4. Press the ∧ key to display 3. 5. Press the SEL key once. 3 will stop flashing and will be registered for <i>PFn</i>. After that, the controller will operate in ramp-soak type 3 6. If you want to display the operation status, press and hold the SEL key for two seconds.

5rAr Ramp-soak status display (Display only)

5u-1 to **5u-8** 1st to 8th target SV (Setting range: $5u-L$ to $5u-H$) (Option)

rAr to **rAr** 1st to 8th ramp segment time (Setting range: 0 to 99h 59min) (Option)

rAs to **rAs** 1st to 8th soak segment time (Setting range: 0 to 99h 59min) (Option)

Mod Ramp-soak modes (Setting range: 0 to 15) (Option)

[Description]

- By these parameters, the SV (Set value) are automatically changed over time according to the patterns set in advance as shown in the figure below. A maximum of 8 ramp-soak segments can be set in PXR.
- The first ramp starts from the PV (Measured value) just before performing the program.
- The program can also be started at power-on automatically (Power-on start function).
- A maximum of eight ramp-soak segments can be set. It is also possible to set 4 ramp-soak segments twice instead.
- When the following parameters are changed under ramp-soak operation, operation will change the patterns of the ramp-soak pattern is changed to the new setting.

- $5u-1$ to $5u-8$
- rAr to rAr
- rAs to rAs
- Mod

[Parameters]

In order to execute these functions, it is necessary to set the programs in advance. To set the programs, set the SV (Setting value) and time desired for the parameters shown in the table on next page.

Related parameters: PFn (page 49)
 $PrOB$ (page 18)
 $5u-L$ (page 54)
 $5u-H$ (page 54)

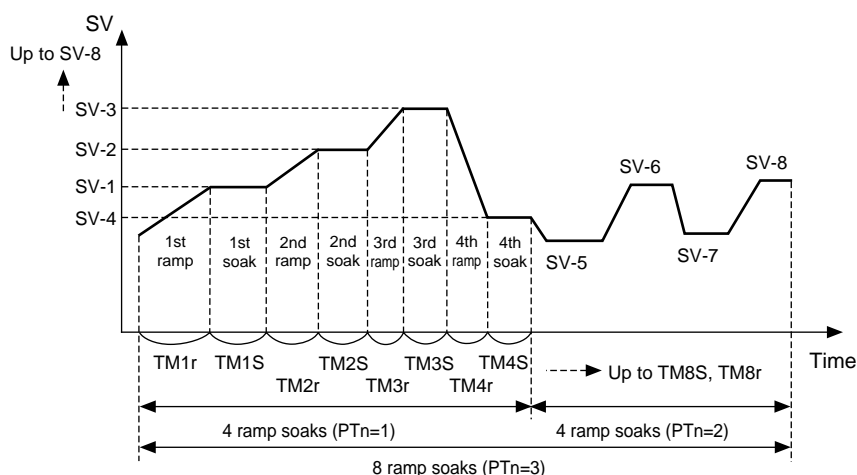

Parameter display symbol	Name		Description	Factory default settings	Remark
<i>STAT</i>	STAT	Current program status	Displays the Ramp-soak current status. This parameter is only for display, and cannot set anything. <i>OFF</i> : OFF <i>1-rP</i> to <i>8-rP</i> : Under the 1st to 8th ramp operation <i>1-Sk</i> to <i>8-Sk</i> : Under the 1st to 8th soak operation <i>End</i> : Ends the program	—	No symbol appears when the ramp-soak model is not selected.
<i>SV-1</i> to <i>SV-8</i>	SV-1 to SV-8	1st to 8th target SV	Sets the target value (SV) of each ramp segment (Setting range: <i>SV-L</i> to <i>SV-H</i>)	0%FS	
<i>TM1r</i> to <i>TM8r</i>	TM1r to TM8r	1st to 8th ramp segment time	Sets the ramp time for each segment (Setting range: 0 to 99h 59min)	0.00	
<i>TM1s</i> to <i>TM8s</i>	TM1s to TM8s	1st to 8th soak segment time	Sets the soak time for each segment (Setting range: 0 to 99h 59min)	0.00	
<i>Mod</i>	Mod	Ramp-soak mode	Selects the modes of ramp-soak function. Set to "0" under normal conditions	0	

[MODE code list]

MOD	Power-on start	Output at the END	Output at OFF	Repeat operation
0	OFF	Continuous control	Continuous control	OFF
1	OFF	Continuous control	Continuous control	ON
2	OFF	Continuous control	Standby mode	OFF
3	OFF	Continuous control	Standby mode	ON
4	OFF	Standby mode	Continuous control	OFF
5	OFF	Standby mode	Continuous control	ON
6	OFF	Standby mode	Standby mode	OFF
7	OFF	Standby mode	Standby mode	ON
8	ON	Continuous control	Continuous control	OFF
9	ON	Continuous control	Continuous control	ON
10	ON	Continuous control	Standby mode	OFF
11	ON	Continuous control	Standby mode	ON
12	ON	Standby mode	Continuous control	OFF
13	ON	Standby mode	Continuous control	ON
14	ON	Standby mode	Standby mode	OFF
15	ON	Standby mode	Standby mode	ON

[Description of functions]

1. Power-on start: The ramp-soak operation starts to run from the current PV value.
2. Output at END: The output status at the END of the ramp-soak operation.
3. Output at OFF: The output status while the ramp-soak operation is set to OFF.
4. Repeat operation: This function makes the ramp-soak operation to continue after one cycle of ramp-soak operation is completed. At the event of Repeat operation: OFF, the SV that is set in the final cycle is kept.

* Standby mode: Output: control output OFF or -3%
 Alarm: OFF
 Control: OFF

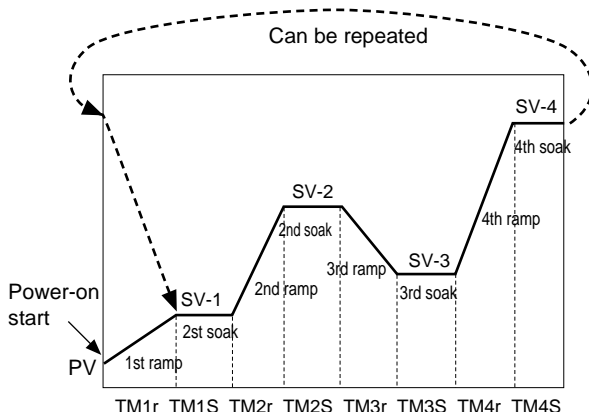

[Ramp]

The segment in which the set value changes toward the target value.

[Soak]

The segment in which the set value is always the target value and remains unchanged.

- The segment in which both the ramp time and soak time are set to "0" is skipped.

[Ex]

SV-1: 50	SV-2:200	SV-3:100
TM1r:0.10	TM2r:0.00	TM3r:1.00
TM1S:0.05	TM2S:0.00	TM3S:0.75

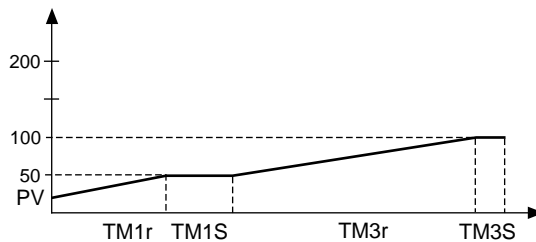

- The SV limit function is valid even while the ramp-soak operation is running.

Although the set value (SV-n) remains unchanged, the SV under ramp-soak operation is affected by the limit function. Therefore, the pattern is as shown in the figure on right, and it may not change according to the original set time.

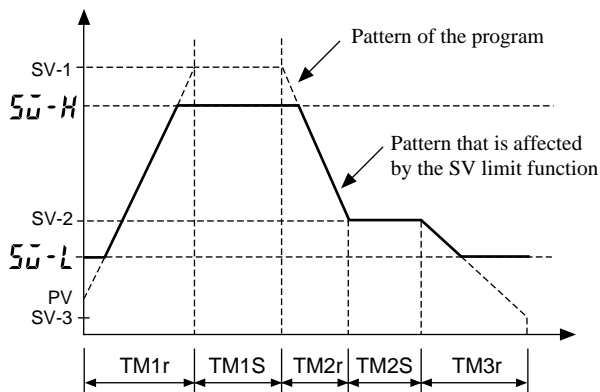

[Setting example] Setting the 1st target SV to 400°C

Display	Operating procedure
	<ol style="list-style-type: none"> Press and hold the [SEL] key for three seconds. p will be displayed on the PV display. Press the [V] key to display 50-1. Press the [SEL] key once. The current setting (0) flashes on the SV display. Press the [^] key to display 400. Press the [SEL] key once. 400 will stop flashing and will be registered for 50-1. If you want to display the operation status, press and hold the [SEL] key for two seconds.

P-n1 Specifying control action, and output direction at input burn-out (Setting range: 0 to 19)

[Description]

- This parameter specifies action (Single/Dual and Heating/Cooling), and output direction at input burn-out.
- The standard model (single output) or the heating/cooling control output (dual output) are available.
- There is difference of hardware between the standard model and the heating/cooling control output model. Set the code that is applicable to your controller.
- In general, reverse action is applied for the heating process and direct action is applied for the cooling process.







* “burn-out output” means the output direction at input burn-out.

* The lower limit of a burn-out output indicates that output is set to OFF, or 4mA or less. The upper limit indicates that output is set to ON, or 20mA or more.

• Control operation code table

Code (P-n1)	Model	Control action		Burn-out output*			
		Output 1	Output 2	Output 1	Output 2		
0	Standard (single)	Reverse	...	Lower limit	...		
1				Upper limit			
2		Direct		Lower limit			
3				Upper limit			
4	Heating /Cooling (dual)	Reverse	Direct	Lower limit	Lower limit		
5				Upper limit	Upper limit		
6				Lower limit			
7				Upper limit			
8				Direct		Lower limit	Lower limit
9						Upper limit	Upper limit
10		Lower limit					
11		Upper limit					
12		Reverse	Reverse		Lower limit	Lower limit	
13					Upper limit	Upper limit	
14				Lower limit			
15				Upper limit			
16	Direct			Lower limit	Lower limit		
17				Upper limit	Upper limit		
18		Lower limit					
19		Upper limit					

[Setting example] Changing the “Reverse/Lower limit for burn-out output” to the “Direct/Upper limit for burn-out output”

Display	Operating procedure
     	<ol style="list-style-type: none"> 1. Press and hold the [SEL] key for five seconds. P-n1 will be displayed on the PV display. 2. Press the [SEL] key once. The current setting (0) flashes on the SV display. 3. Press the [▲] or [▼] keys to display 3. 4. Press the [SEL] key once. 3 will stop flashing and will be registered for P-n1. After that, the controller will operate with the “Direct/Upper limit for burn-out output” selected. 5. If you want to display the operation status, press and hold the [SEL] key for two seconds.

SV-L SV (Setting value) lower limiter (Setting range: 0 to 100%FS)

SV-H SV (Setting value) upper limiter (Setting range: 0 to 100%FS)

[Description]

- These parameters set the setting range of the SV (Setting value).
- Both the SV under ramp-soak operation and the SV switched by the DI1 function are affected by the SV limiter.
- The SV upper and lower limiters (**SV-H**, **SV-L**) can be set within the range of the measuring values (**P-SL**, **P-SU**).

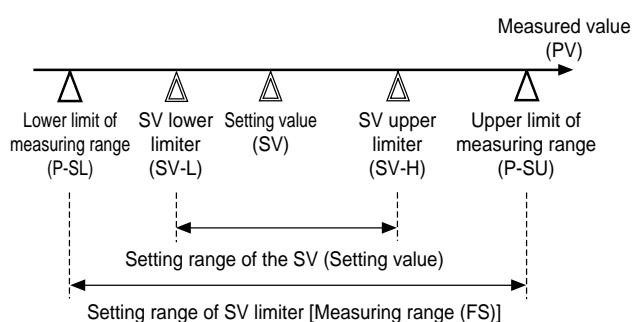

[Note]

- Before setting the parameters of **SV-H** and **SV-L**, be sure to set the following parameters.
 - Setting the lower limit of the measured range (**P-SL**)
 - Setting the upper limit of the measured range (**P-SU**)
 - Setting the of decimal places point position (**P-dP**)
- After changing the parameters of **P-SL**, **P-SU**, and **P-dP**, power off the PXR, and then on. Then, set the parameters of **SV-H** and **SV-L** again.
- Before setting the SV, set the parameters of **SV-H** and **SV-L**.
- Be sure to set the values of **SV-H** and **SV-L** so that **SV-H** is larger than **SV-L** or **SV-H** is the same as **SV-L**.
- Although the displayed SV is affected by the limiter immediately after setting **SV-H** and **SV-L**, the set values of **SV-1** to **SV-8** are not affected.
- When the SV limiter is set during ramp-soak operation or switching the SV with the DI1 function, the SV (SV0) that is set manually and the displayed SV are affected by the SV limiter. So, after setting the ramp-soak operation to OFF, or returning the switched SV to the original SV, the PXR operates with the SV0 affected by the SV limiter.

[Setting example] Setting the upper limiter to 100°C

Display	Operating procedure
 	<p>1. Press and hold the SEL key for five seconds. P-n 1 will be displayed on the PV display.</p>
	<p>2. Press the key to display SV-H.</p>
	<p>3. Press the SEL key once. The current setting (400) flashes on the SV display.</p>
	<p>4. Press the or keys to display 100.</p>
	<p>5. Press the SEL key once. 100 will stop flashing and will be registered for SV-H. After that, the upper limit of the SV will be 100°C.</p>
	<p>6. If you want to display the operation status, press and hold the SEL key for two seconds.</p>

dLY1 , **dLY2** , **dLY3**

The time of ON-delay alarm or timer function

(Setting range: 0 to 9999 seconds)

[Description]

ON-delay alarm

- With this function, the alarm relay is closed after the pre-determined delay time. (See operation ① shown in the figure below.)
- In case the cause of the alarm is solved within the delay time, the alarm relay is not closed. (See operation ③ shown in the figure below.)
- The alarm relay is opened regardless of this parameter. (See operation ② shown in the figure below.)

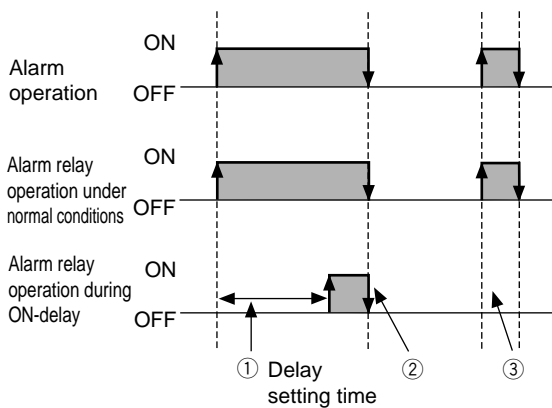

- In case the alarm is set to OFF during standby, the ON-delay operation performs again when returning to RUN.
- When the delay time is changed during ON-delay operation, the alarm is activated in the changed delay time.

Timer function

- When the ON-delay timer is selected (ALMn = 32), the relay is closed in the set time after DI input is set to ON. While the DI input stays OFF, the timer cannot be activated.
- When the OFF-delay timer is selected (ALMn = 33), the timer cannot be activated while the DI input is set to ON. The relay is closed in the set time after DI input is set to OFF.
- When the ON/OFF-delay timer is selected (ALMn = 34), the timer is activated while the DI input stays either ON or OFF.

- The timer display function shows the remaining time of timers 1, 2 and 3.
- The set time is counted down while the ON or OFF timer is activated.
- While the ON timer is activated, the alarm relay is closed when the remaining time is 0. While the OFF timer is activated, the alarm relay is opened when the remaining time is 0.

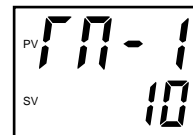



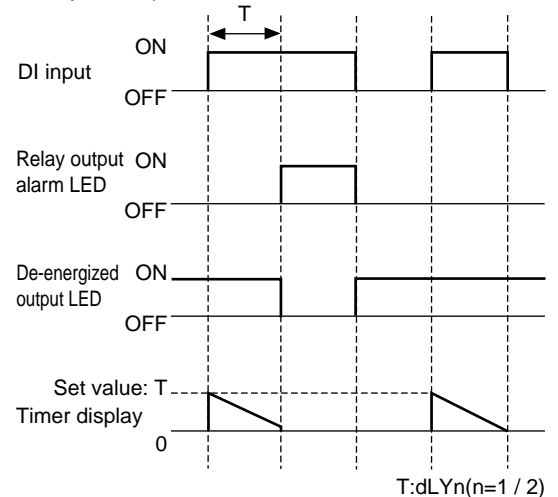



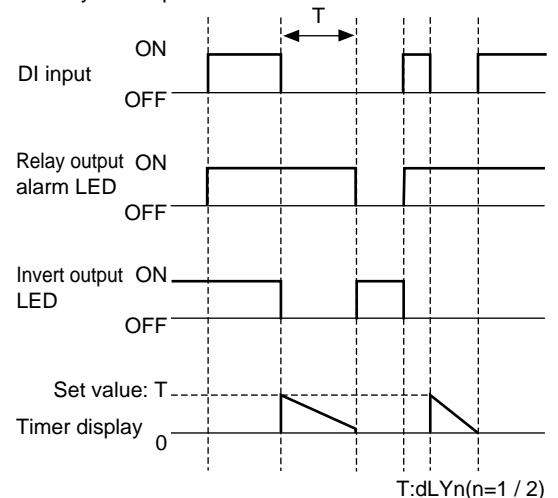



• ON-delay timer operation



• OFF-delay timer operation



[Setting example] Setting the delay time for ON-delay alarm to 30 seconds

Display	Operating procedure
	<p>1. Press and hold the SEL key for five seconds.</p>
	<p><i>P-n l</i> will be displayed on the PV display.</p>
	<p>2. Press the  key to display <i>dL y l</i>.</p>
	<p>3. Press the SEL key once.</p> <p>The current setting (0) flashes on the SV display.</p>
	<p>4. Press the  or  keys to display 30.</p>
	<p>5. Press the SEL key once. 30 will stop flashing and will be registered for <i>dL y l</i>. After that, the controller will operate with the ON-delay alarm being 30 seconds.</p>
	<p>6. If you want to display the operation status, press and hold the SEL key for two seconds.</p>

CF Displaying current detector input (Display only) (Option)

Hb HB (Set value of heater break alarm) (Setting range: 0.0 to 50.0 A) (Option)

[Description]

- When **Hb** is set to 0.0, the HB alarm is turned OFF.
- The point at which the alarm is activated can be set in the parameter of **Hb**.
- There are two types of the current transformers (CT) available: CTL-6-SF type for 1 A to 30 A and CTL-12-S36-8F type for 20 A to 50 A. Select the suitable type to the current value of the heater you use.
- How to set the point at which the alarm is activated:
 - Set the output of the PXR to ON continuously to provide the current to the heater.
 - You can monitor the current value of the heater in the parameter of **CF**. Set the value that is 70 to 80 % of the monitored current value as the final set value.
 - When the number of heaters is “n” (more than two), set the middle value between the current of “n” heaters and the current of (“n”-1) heaters.
- When the thyristor (SCR) phase control system is used to control the heater, the parameters of **CF** and **Hb** cannot be used.
- In case detection of an error becomes difficult due to insufficient heater capacity, pass the wire through the CT twice to double the apparent current. This will improve the sensitivity of the CT. (In this case, set the value that is twice as much as the original value.)
- When winding the wire around the CT several times, be sure to wind in the same direction.

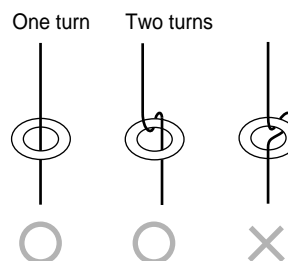

[Note]

To detect heater current, control output 1 must be kept on for 0.5 second or longer.

Related parameter: **FL** (page 37)

• Connection example for the alarm for heater break (PXR4 model)

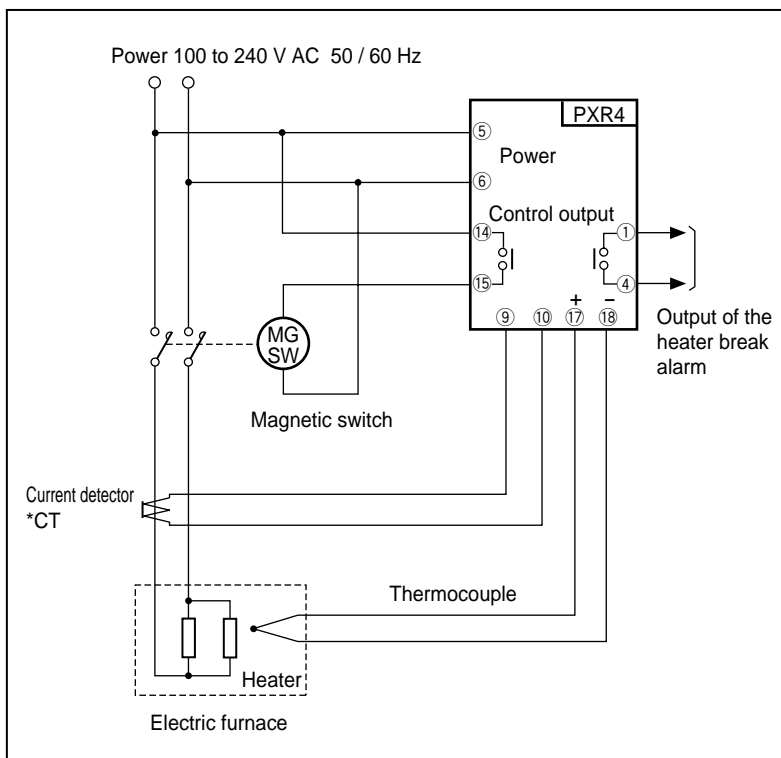

• How to connect the current transformer (CT) for heater break:

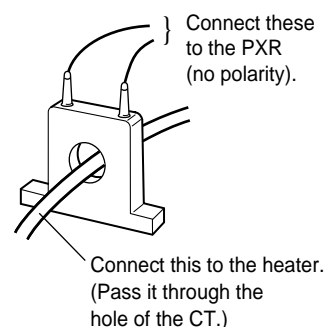

- Connection example for the alarm for heater break (PXR5/9 model)

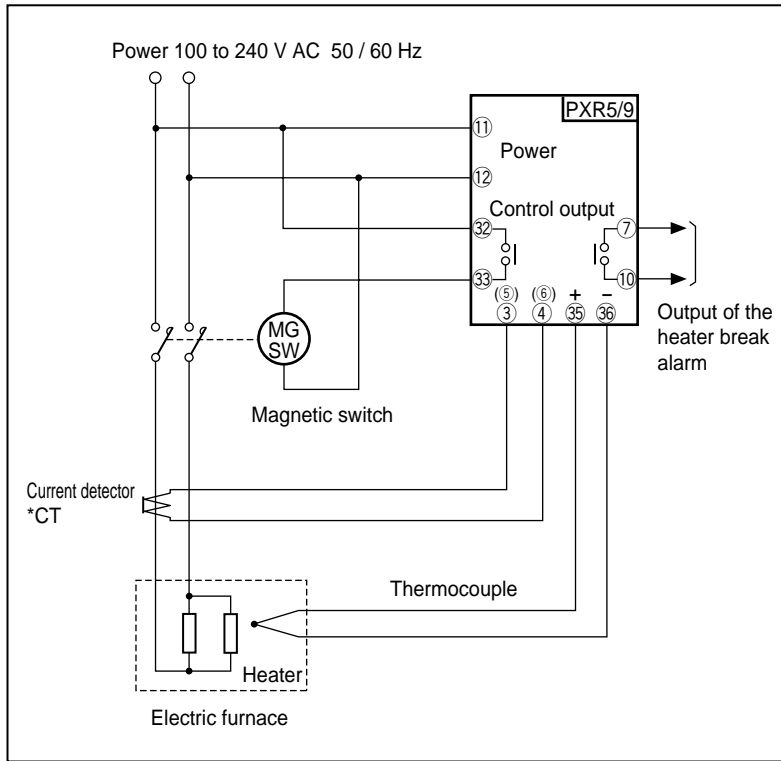

[Setting example] Changing the detecting current of heater break from 8.0 A to 9.0A

Display	Operating procedure
	<ol style="list-style-type: none"> 1. Press and hold the [SEL] key for five seconds. P-n l will be displayed on the PV display. 2. Press the key to display Hb. 3. Press the [SEL] key once. The current setting (80) flashes on the SV display. 4. Press the or keys to display 90. 5. Press the [SEL] key once. 90 will stop flashing and will be registered for Hb. After that, the controller will operate with detecting current of heater break being 9.0A 6. If you want to display the operation status, press and hold the [SEL] key for two seconds.

A1hy , **A2hy** , **A3hy** Hysteresis of alarm 1, 2 and 3 (Setting range: 0 to 50% FS)
(Option)

[Description]

- The alarm is detected in the two-position operation (ON/OFF). The hysteresis means the difference between the input at ON and the input at OFF. For example, the hysteresis of 5°C means that the range between ON and OFF is 5°C.
- As to the decimal point position, the setting at **P-dP** is respected.
- Hysteresis can be set for each alarm.

• Upper limit alarm

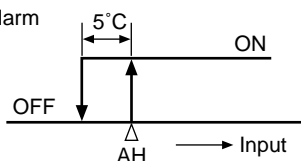

• Lower limit alarm (AL)

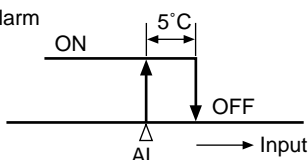

• Range alarm

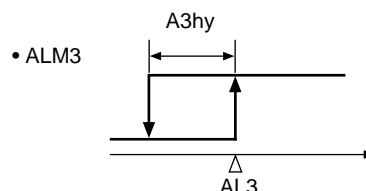
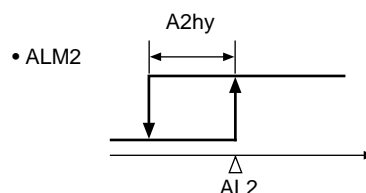
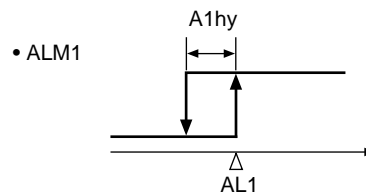
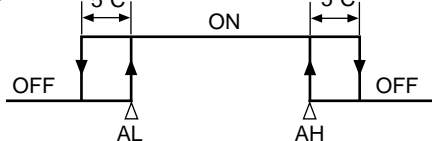

[Setting example] Changing the hysteresis of alarm 2 from 1°C to 3°C

Display	Operating procedure
 	<p>1. Press and hold the SEL key for five seconds. P-n 1 will be displayed on the PV display.</p>
	<p>2. Press the key to display A2hy.</p>
	<p>3. Press the SEL key once. The current setting (1) flashes on the SV.</p>
	<p>4. Press the or keys to display 3.</p>
	<p>5. Press the SEL key once. 3 will stop flashing and will be registered for A2hy. After that, the controller will operate with the hysteresis of alarm 2 being 3°C.</p>
	<p>6. If you want to display the operation status, press and hold the SEL key for two seconds.</p>

A1oP , **A2oP** , **A3oP**

Options of alarm 1, 2 and 3 (Setting range: 000 to 111)
(Option)

[Description]

- These parameters are used to switch ON/OFF of the alarm latch, the error status alarm, and the de-energized output alarm functions for each of Alarm 1, 2 and 3.
- Each function is set to ON by setting the following digit to “1”:

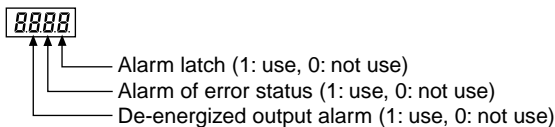

- The alarm latch is the function to keep the alarm ON, once the alarm judgment shows the alarm ON status. To cancel the alarm latch, follow the instructions below.
 - Power off the PXR, and then on.
 - Set the alarm latch to OFF.
 - Cancel the alarm latch at the alarm latch canceling parameter.
 - Cancel the alarm latch by DI input.
 - Cancel the alarm latch via communication.
- The alarm of error status is activated, when the problems in the table below occur. When using this error status alarm function, set the alarm types (ALM1, 2 or 3) to “0”.

Display	Causes
UUUU	<ul style="list-style-type: none"> • A break in the thermocouple sensor • A break in the resistance bulb sensor (RTD) (A) • The PV reading value exceeds the P-SU by 5%FS or more.
LLLL	<ul style="list-style-type: none"> • A break in the resistance bulb sensor (B) or (C) • The resistance bulb sensor (A-B) or (A-C) is short-circuited. • The PV reading value is below the P-SL by 5%FS or more. • A break or a short-circuit in the voltage input line.



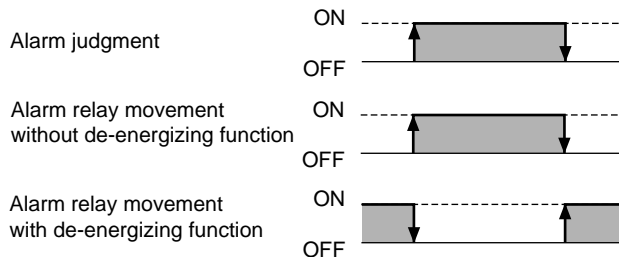







- The de-energized output alarm function is used for energizing or de-energizing the alarm relay to be closed. While this function is set to ON, when the alarm judgment shows the ON status, the relay is opened, and when the alarm judgment shows the OFF status, the relay is closed.



[Note]

- The ON-delay, the alarm latch, and the de-energized output functions can be activated for the error status alarm.
- The alarm lamps (AL1, AL2, AL3) goes on and off according to the alarm judgment regardless of the de-energized output settings.

[Setting example] Setting the error status alarm function for Alarm 2 to ON

Display	Operating procedure
	<p>1. Press and hold the [SEL] key for five seconds.</p>
	<p><i>P-n l</i> will be displayed on the PV display.</p>
	<p>2. Press the  key to display <i>R2oP</i>.</p>
	<p>3. Press the [SEL] key once.</p> <p>The current setting (<i>000</i>) flashes on the SV display.</p>
	<p>4. Press the  or  keys to display <i>0 10</i>.</p>
	<p>5. Press the [SEL] key once. <i>0 10</i> will stop flashing and will be registered for <i>R2oP</i>. After that, the controller will operate with the error status alarm function for Alarm 2 being ON.</p>
	<p>6. If you want to display the operation status, press and hold the [SEL] key for two seconds.</p>

PLC1 , **PHC1** Upper and lower limits for control output 1 (Setting range: -3.0 to 103.0%)

PLC2 , **PHC2** Upper and lower limits for control output 2 (Setting range: -3.0 to 103.0%) (Option)

[Description]

- These parameters set the limit value of output.

	Upper limit	Lower limit
OUT1	PHC1	PLC1
OUT2	PHC2	PLC2

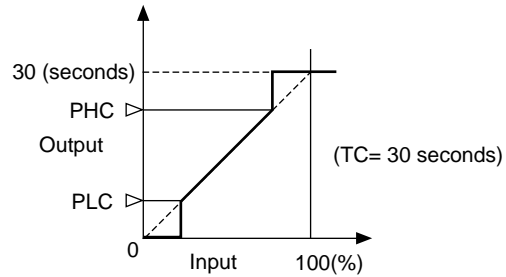

- How the output is limited (maintained within the limit or breaks the limit) is set in the parameter of **PCUF** .
- When flammability is controlled by turning the gas on and off, this function can avoid flashing.

Related parameters: **FC** (page 37)
PCUF (page 63)

$$(\text{Minimum ON pulse width [seconds]}) = \text{PLC1} \times \frac{100}{\text{TC}}$$

$$(\text{Minimum OFF pulse width [seconds]}) = (100 - \text{PHC1}) \times \frac{100}{\text{TC}}$$

FC : Cycle time

[Setting example] Changing the lower pulse width limit from 20.0% to 10.0%

Display	Operating procedure
 	<ol style="list-style-type: none"> 1. Press and hold the SEL key for five seconds. <i>P-n 1</i> will be displayed on the PV display.
	<ol style="list-style-type: none"> 2. Press the key to display PLC1 .
	<ol style="list-style-type: none"> 3. Press the SEL key once. The current setting (<i>200</i>) flashes on the SV display.
	<ol style="list-style-type: none"> 4. Press the or keys to display <i>100</i> .
	<ol style="list-style-type: none"> 5. Press the SEL key once. <i>100</i> will stop flashing and will be registered for PLC1 . After that, the controller will operate with the output lower limit being 10%.
	<ol style="list-style-type: none"> 6. If you want to display the operation status, press and hold the SEL key for two seconds.

PCUR Output limit types (Setting range: 0 to 15)

[Description]

- This parameter sets whether or not to maintain the value within the limit when the output value increases up to the limit set value.

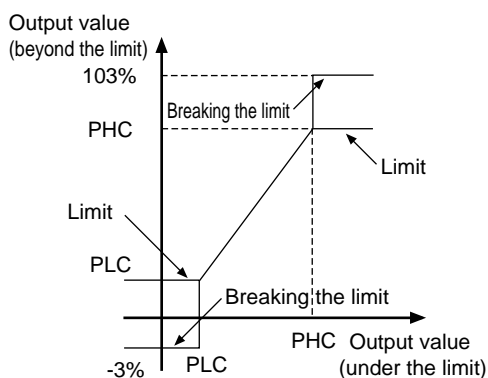

PCUT	Output 1		Output 2	
	Upper limit	Lower limit	Upper limit	Lower limit
0	103%	-3%	103%	-3%
1	103%	Limit	103%	-3%
2	Limit	-3%	103%	-3%
3	Limit	Limit	103%	-3%
4	103%	-3%	103%	Limit
5	103%	Limit	103%	Limit
6	Limit	-3%	103%	Limit
7	Limit	Limit	103%	Limit
8	103%	-3%	Limit	-3%
9	103%	Limit	Limit	-3%
10	Limit	-3%	Limit	-3%
11	Limit	Limit	Limit	-3%
12	103%	-3%	Limit	Limit
13	103%	Limit	Limit	Limit
14	Limit	-3%	Limit	Limit
15	Limit	Limit	Limit	Limit

[Setting example] Selecting the operation that outputs 1 and 2 are maintained within the upper and lower limits

Display	Operating procedure
 	<ol style="list-style-type: none"> Press and hold the [SEL] key for five seconds. P-n l will be displayed on the PV display. Press the [V] key to display PCUR . Press the [SEL] key once. The current setting (0) flashes on the SV display. Press the [^] or [v] keys to display 15 . Press the [SEL] key once. 15 will stop flashing and will be registered for PCUR . After that, the controller will operate with outputs 1 and 2 maintained within the upper and lower limits. If you want to display the operation status, press and hold the [SEL] key for two seconds.

Output value display (Display only: -3.0 to 103.0%)

[Description]

- These parameters display the output values of outputs 1 and 2 in the unit of %. (Since the values are calculated with the software, they may have some error comparing to the actual output.)

[Setting example] Confirming the output value (the calculated value) of control output 1











Display	Operating procedure
 	<ol style="list-style-type: none"> 1. Press and hold the key for five seconds. <i>P-n 1</i> will be displayed on the PV display. 2. Press the key to display <i>out 1</i>. The output value will appear in the SV display. 3. If you want to display the operation status, press and hold the key for two seconds.

rcj RCJ (Cold junction compensation) (Setting range: ON/OFF)

[Description]

- This parameter sets whether or not to perform the RCJ (Cold junction compensation) for the thermocouple input. Use the factory default setting (ON: performs the RCJ) under normal conditions.
 - ON: Performs the RCJ (Cold junction compensation).
 - OFF: Does not perform the RCJ (Cold junction compensation).
- Set this parameter to OFF under the conditions that the RCJ is not needed, such as when the RCJ is performed outside of the PXR or when the temperature deviations are recorded.

[Setting example] Changing the RCJ (Cold junction compensation) from ON to OFF

Display	Operating procedure
	<ol style="list-style-type: none"> 1. Press and hold the SEL key for five seconds. P-nl will be displayed on the PV display. 2. Press the  key to display rcj. 3. Press the SEL key once. The current setting (on) flashes on the SV display. 4. Press the  or  keys to display off. 5. Press the SEL key once. off will stop flashing and will be registered for rcj. After that, the controller will operate with the RCJ (Cold junction compensation) being off. 6. If you want to display the operation status, press and hold the SEL key for two seconds.
	
	
	
	
	
	

Adj0 Adjusting the PV (Measured value) display (0%) (Setting range: -50 to 50% FS)

Adj5 Adjusting the PV (Measured value) display (100%) (Setting range: -50 to 50% FS)

[Description]

- The user-definable functions are independent of the adjustment values of the PXR. Setting the parameters of **Adj0** and **Adj5** to 0 can return to the factory default settings.

1. Prepare the following devices before adjustment by using these parameters.

- DC voltage standard generator
 - 1 to 5V (for voltage input)
 - 0 to 100 mV (for thermocouple input)
- Decade resistance box
 - 100.0 to 400.0 Ω (for resistance bulb input)

2. Set the parameter of **rCU** to OFF.

3. Apply a voltage that is equivalent of 0%.

If there is an error large enough to impair its accuracy, set the parameter of **Adj0**. (See the right example to set **Adj0**.)

4. Apply a voltage that is equivalent of 100%.

If there is an error large enough to impair its accuracy, set the parameter of **Adj5**. (See the right example to set **Adj5**.)

5. Return the parameter of **rCU** to ON.

[Operating example for input range of 0°C to 400°C]

{ Reading at input of 0°C: -1°C
 { Reading at input of 400°C: 402°C

Set the parameter of **Adj0** to "1".

Set the parameter of **Adj5** to "-2".

Therefore;











{ Reading at input of 0°C: 0°C
 { Reading at input of 400°C: 400°C

[Adjustment example for input range of 0 to 400°C]

Before adjustment	Adjustment value	After adjustment
Display at input of 0°C: -1°C	Adj0 : 1	Display at input of 0°C: 0°C
Display at input of 400°C: 402°C	Adj5 : -2	Display at input of 400°C: 400°C

Setting the parameters of **Adj0** and **Adj5** to "0" returns to the factory default settings.

[Setting example] Setting the zero adjustment to "+1°C"

Display	Operating procedure
      	<p>1. Press and hold the SEL key for five seconds. P-n I will be displayed on the PV display.</p> <p>2. Press the  key to display Adj0.</p> <p>3. Press the SEL key once. The current setting (0) flashes on the SV display.</p> <p>4. Press the  or  keys to display 1.</p> <p>5. Press the SEL key once. 1 will stop flashing and will be registered for Adj0. After that, the controller will operate with the zero adjustment being +1°C.</p> <p>6. If you want to display the operation status, press and hold the SEL key for two seconds.</p>

d_L-1 **d_L-2** DI operation (Setting range: 0 to 12) (Option)

[Description]

- Select each DI function with **d_L-1** and **d_L-2** (DI setting parameter) and set the DI to ON to activate the functions.

Setting range: 0 to 12

- 0** = No function
- 1** = Switches the SV.
- 2** = Control RUN/Standby
- 3** = Starts the auto tuning (standard).
- 4** = Starts the auto tuning (low PV).
- 5** = Cancels latching for all alarms.
- 6** = Cancels latching for alarm 1.
- 7** = Cancels latching for alarm 2.
- 8** = Cancels latching for alarm 3.
- 9** = Activates ALM 1 relay timer.
- 10** = Activates ALM 2 relay timer.
- 11** = Activates ALM 3 relay timer.
- 12** = Ramp-soak operation RUN/RESET

Switching the SV (DI function 1)

- This function switches the SV.

(Exp.) In case of switching SV 4 points

DI set parameter, DI and type of SV to be switched and selected

d_L-1 Set value	d_L-2 Set value	DI2 OFF		DI2 ON	
		DI1 OFF	DI1 ON	DI1 OFF	DI1 ON
1	1	S_V	S_V-1	S_V-2	S_V-3

- S_V-1** of the ramp-soak target SV is used to set the SV 1.
- The SV cannot be changed on the SV display screen while **S_V-1** is selected.
- While switching the SV, the SV and the SV No. appear alternately. (SV: 2 seconds, SV No.: 1 second) However, the SV No. is not displayed during the ramp-soak operation.

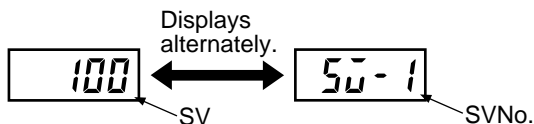

Ramp-soak operation RUN/RESET (DI function 12)

- The ramp-soak operation is switched between RUN/RESET by DI.

DI ON edge ↑: RUN

DI OFF edge ↓: RESET

[Note]

RUN and RESET are switched by ON and OFF edge of DI.

- The ramp-soak operation can be also switched between RUN/RESET manually.
- The ramp-soak execute types that are set in the parameter of **P_{Fn}** operate.
- The table below shows the operations when the DI changes during ramp-soak operation.

Ramp-soak operation status	DI	
	ON edge	OFF edge
RUN	No change	RESET
RESET	RUN	No change
HOLD	RUN	RESET
END	No change	RESET

- When the settings are set manually, via communication, and DI, the settings that are set later are valid.

Switching control RUN/Standby (DI function 2)

- RUN and Standby mode is switched by DI

DI ON : Standby

DI OFF: RUN

- When the control is in standby state,

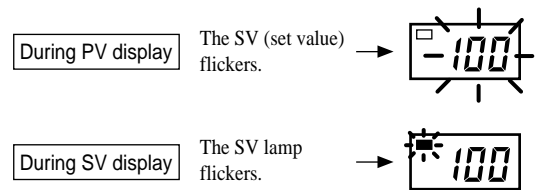

- The control can also be switched between RUN/Standby manually.

Select ON or OFF in the parameter for **S_{TbY}** (Setting standby).

S_{TbY} setting screen (the first block)

Display during OFF: Control RUN mode

Display during ON: Control Standby mode

off

on

- The table below shows the relationship between the RUN and Standby mode switched with a manual operation, DI 1, and ramp-soak operation.

DI	Standby status of ramp-soak operation			
	OFF		ON	
	Manual setting			
	OFF	ON	OFF	ON
DI OFF	RUN	Standby	Standby	Standby
DI ON	Standby	Standby	Standby	Standby

Starting the auto-tuning (DI functions 3, 4)

- These functions can switch the start/stop of the auto-tuning.

DI function	DI ON edge	DI OFF edge
AT (Standard)	AT start	AT cancel
AT (Low PV)		

Cancel the alarm latch (DI functions 5 to 8)











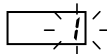

- These functions can cancel the alarm latch while alarms are latched by setting the alarm latch function to ON.

Set value of $d\bar{L}-1$ or $d\bar{L}-2$	DI ON	DI OFF
5	Cancels the latching for alarms 1 and 2	Keeps the alarm latching
6	Cancels the latching for alarm 1	
7	Cancels the latching for alarm 2	
8	Cancels the latching for alarm 3	

Timer operation (DI functions 9 to 11)

- The DI can set the ON/OFF of timer while codes 32 to 34 are set in “Setting alarm types” (page 46). For the operation, see page 46.

[Setting example] Changing the SV (Front SV) to SV1

Display	Operating procedure
<p> PV indication</p> <p> P-n I</p> <p> dL-I</p> <p> 0</p> <p> I</p> <p> dL-I</p>	<ol style="list-style-type: none"> 1. Press and hold the SEL key for five seconds. P-n I will be displayed. 2. Press the  key to display dL-I. 3. Press the SEL key once. The current setting (0) will be displayed. 4. Press the  or  keys to flicker and to display I. 5. Press the SEL key once. dL-I will be displayed and 1 will be registered for dL-I. (Repeat the procedure from 3 to 5 to check the set value.) 6. Short-circuit the Di1 terminals. The SV will be changed from the front SV to SV1.
<p> SV indication</p>	<ol style="list-style-type: none"> 7. If you want to display the operation status, press and hold the SEL key for two seconds. The SV value and SV No. will appear alternately. The switched SV or  will be displayed alternately on the display area.
<p> PV indication</p>	<p>If unoperated state continues, the PV will be displayed.</p>















St no

Station No. for communication (Setting range: 0 to 255)

[Description]

- Do not set the same number as other Micro-controllers.
- See Communication function instruction manual for details.

[Setting example] Setting the station No. to "123"

Display	Operating procedure
	1. Press and hold the SEL key for five seconds. <i>P-n!</i> will be displayed on the PV display.
	
	2. Press the  key to display <i>St no</i> .
	
	3. Press the SEL key once. The current setting (<i>!</i>) flashes on the SV display.
	
	4. Press the  or  keys to display <i>123</i> .
	
	5. Press the SEL key once. <i>123</i> will stop flashing and will be registered for <i>St no</i> . After that, the controller will operate with the station number being 123.
	6. If you want to display the operation status, press and hold the SEL key for two seconds.
	

[Note]

- In the case of Modbus (RTU) communication specifications, communication is prohibited if the station No. is set to 0.
- In the case of Z-ASCII communication specifications, communication is allowed even if the station No. is set to 0.

LoP Parity for communication (Setting range: 0 to 2)











[Description]

- This parameter sets the parity for communications.

The baud rate is fixed at 9600bps.

- 0 : Odd parity
- 1 : Even parity
- 2 : No parity

[Setting example] Setting the even parity

Display	Operating procedure
      	<ol style="list-style-type: none"> Press and hold the SEL key for five seconds. P-n 1 will be displayed on the PV display. Press the  key to display LoP. Press the SEL key once. The current setting (0) flashes on the SV display. Press the  or  keys to display 1. Press the SEL key once. 1 will stop flashing and will be registered for LoP. However, it does not switch to the even parity at this point. Power off the PXR, and then on. The even parity is set now.

Prcl Communication protocol setting (Setting range: 0 to 1) (Option)

[Description]

- This parameter is used to switch communication protocols.











Set value	Output type
1	Modbus (RTU) protocol
0	Z-ASCII protocol

* See the following communication specifications for details of each protocol.

- Instruction manual for Micro Controller X communication functions (RS485 MODBUS)INP-TN512642-E
- Instruction manual for Micro Controller X communication functions (RS485 Z-ASCII)INP-TN512644-E

Related parameters: **Sfrno** (page 70)
Con (page 71)

[Setting example] Changing to Z-ASCII protocol

Display	Operating procedure
      	<ol style="list-style-type: none"> Press and hold the SEL key for 5 seconds. <i>P-n I</i> will be displayed in the PV display section. Press the  key to display Prcl. Press the SEL key once. The current set value (<i>i</i>) in the SV display section flickers. Press the  and  keys to display 0. Press the SEL key once. Flickering stops and 0 will be registered in Prcl. The operation is then performed using Z-ASCII protocol. To display the operation status, press and hold the SEL key for 2 seconds.

R₀-r Re-transmission output type setting (Setting range: 0 to 3) (Option)

[Description]

- This parameter is used to set the retransmission output type.



The means of the set values are as shown below.

Set value	Output type
0	PV
1	SV
2	MV
3	DV

Related parameters: **R₀-L** (page 74)

R₀-H (page 74)

[Setting example] Changing the retransmission output type from the process value (PV) to the set value (SV)

Display	Operating procedure
<div style="border: 1px solid black; padding: 2px; display: inline-block;">25</div> PV indication <div style="border: 1px solid black; padding: 2px; display: inline-block;">P-n I</div> <div style="border: 1px solid black; padding: 2px; display: inline-block;">R₀-r</div> <div style="border: 1px solid black; padding: 2px; display: inline-block;">0</div> <div style="border: 1px solid black; padding: 2px; display: inline-block;">- I -</div> <div style="border: 1px solid black; padding: 2px; display: inline-block;">R₀-r</div>	<ol style="list-style-type: none"> Press and hold the SEL key for 5 seconds. P-n I will be displayed. Press the  key to display R₀-r. Press the SEL key once. The current setting (0 : PV retransmission) will be displayed. Press the  or  key to flicker and to display I (SV retransmission). Press the SEL key once. R₀-r will be displayed and 1 (SV retransmission) will be registered for the retransmission output type. After that, the controller will operate with the retransmission output being SV. (Repeat the procedure from 3 to 5 to check the set value.) If you want to display the operation status, press and hold the SEL key for two seconds. The SV will be displayed on the display area.
<div style="border: 1px solid black; padding: 2px; display: inline-block;">25</div> SV indication	
<div style="border: 1px solid black; padding: 2px; display: inline-block;">25</div> PV indication	If unoperated state continues, the PV will be displayed.

Ao-L

Re-transmission base scale (Setting range: -100.0 to 100.0%) (Option)

Ao-H

Re-transmission span scale (Setting range: -100.0 to 100.0%) (Option)

[Description]

- The retransmission base scale and span scale can be set as shown below. Unit for the setting is %.

Output type	Description of percentage
PV/SV/DV	Percentage of input measurement range (Note 1)
MV	Output value

Note 1: Calculate the set value by using the following formula (refer also to the setting example shown below).

$$\text{Set value (\%)} = (A \div B) \times 100 [\%]$$

A = Temperature to be set – Set value of parameter “P-SL”

B = Set value of parameter “P-SU” – Set value of “P-SL”

- When the value of retransmission output (example: SV) becomes equal to the set value of Ao-L, the retransmission output becomes 0% (output).
- When the value of retransmission output (example: PV) becomes equal to the set value of Ao-H, the retransmission output becomes 100% (output).

Related parameters: **Ao-F** (page 73)

[Note]

- Be sure to always set **Ao-L** smaller than **Ao-H**.













[Setting example] At K thermocouple input of 0 to 400°C, make the setting so that the PV (value of retransmission output type) becomes 0% at 100°C, and 100% at 300°C.



Since the measurement range is 0 to 400°C, P – SL = 0 (lower limit value of measurement range), and P – SU = 400 (upper limit value of measurement range). So, from the formula shown above,

$$A = (100^\circ\text{C} - 0) \text{ or } (300^\circ\text{C} - 0), B = 400 - 0 = 400$$

1) Setting Ao-L : What position is 100°C in the temperature range from 0 to 400°C ? = 25% (= (100 - 0) ÷ 400 × 100 [%]) → Ao-L = 25.0 (%)

2) Setting Ao-H : What position is 300°C in the temperature range from 0 to 400°C ? = 75% (= (300 - 0) ÷ 400 × 100 [%]) → Ao-H = 75.0 (%)

Display	Operating procedure
         	<ol style="list-style-type: none"> Press and hold the [SEL] for five seconds. P-n l will be displayed. Press the [V] key to display Ao-L. Press the [SEL] key once. The current setting value will be displayed. Press the [^] or [v] key to flicker and to display 250. Press the [SEL] key once. Ao-L will be displayed and 250 will be registered for the retransmission base scale. (Repeat the procedure from 3 to 5 to check the set value.) Press the [V] key to display Ao-H. Press the [SEL] key once. The current setting value will be displayed. Press the [^] or [v] key to flicker and to display 750. Press the [SEL] key once. Ao-H will be displayed and 750 will be registered for the retransmission span scale. (Repeat the procedure from 7 to 9 to check the set value.) If you want to display the operation status, press and hold the [SEL] key for two seconds. The SV will be displayed on the display area. If unoperated state continues, the PV will be displayed.
 	

-  Remote SV input (0%) adjustment (Setting range: -50 to 50% FS) (Option)
-  Remote SV input (100%) adjustment (Setting range: -50 to 50% FS)











[Description]

* These parameters are used to correct the deviation of remote SV input.
By setting 0 to the parameters, the status at the time of delivery from the factory can be restored.

1. To correct the deviation from zero point (0% input side)
 - (1) Enter the value equivalent to 0% to remote SV.
 - (2) Check that $r5\bar{u}$ is displayed, and then check the deviation of SV value on the 0% side.
 - (3) Enter in $rEN0$ the value to correct the deviation observed in (2).
 - (4) Check on the $r5\bar{u}$ display that the input has been corrected.
2. To correct the deviation of span point (on 100% input side)
 - (1) Enter the value equivalent to 100% to remote SV.
 - (2) Check that $r5\bar{u}$ is displayed, and then check the deviation of SV value on the 100% side.
 - (3) Enter in $rEN5$ the value to correct the deviation observed in (2).
 - (4) Check on the $r5\bar{u}$ display that the input has been corrected.

Related parameters: $ENod$ (page 17)
 $r-dF$ (page 76)
 $r5\bar{u}$ (page 77)

[Setting example] Setting zero adjustment +1°C

Display	Operating procedure
	1. Press and hold the SEL key for 5 seconds. $P-n!$ will be displayed in the PV display section.
	
	2. Press the \checkmark key to display $rEN0$.
	
	3. Press the SEL key once. The current set value (\bar{d}) in the SV section flickers.
	
	4. Press the \wedge and \checkmark keys to display $!$.
	
	5. Press the SEL key once. Flickering stops and $rEN0 = 1^\circ C$ is registered. The operation is then performed at zero adjustment +1°C.
	
	6. To display the operation status, press and hold the SEL key for 2 seconds.

r-dF Remote SV input filter constant (Setting range: 0.0 to 900.0 seconds)

[Description]



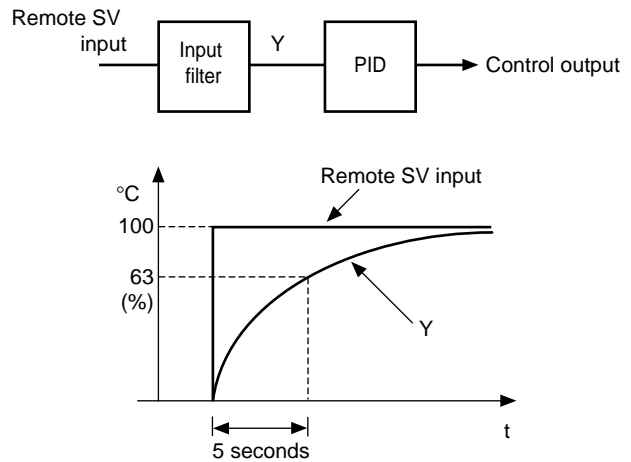







- This parameter is used to make the input signal fluctuation range smaller (filtering function).
Suppose that the input filter constant is set to 5 seconds. If the input is suddenly changed from 0 to 100%, the PV display gradually changes as shown in the figure on the right, and it takes 5 seconds to change from 0 to 63.2%.



[Note]

- The value is set to 0.0 at the time of delivery (filter OFF). Do not change the value unless required.

[Setting example] Changing the filter constant from 0.0 (filter OFF) to 5.0 (5 seconds)

Display	Operating procedure
 	<ol style="list-style-type: none"> Press and hold the SEL key for 5 seconds. P-n l will be displayed in the PV display section.
	<ol style="list-style-type: none"> Press the  key to display r-dF.
	<ol style="list-style-type: none"> Press the SEL key once. The current set value (00) in the SV display section flickers.
	<ol style="list-style-type: none"> Press the  and  keys to display 50.
	<ol style="list-style-type: none"> The operation will then be performed with the filter constant of 5.0 seconds.
	<ol style="list-style-type: none"> To display the operation status, press and hold the SEL key for 2 seconds.







Remote SV input value display (Display only: -1999 to 9999) (Option)

[Description]

- These parameters are used to correct the deviation of remote SV input.

(The value obtained by calculations for remote SV input filter and remote SV input adjustment is displayed as $r\ 5\bar{u}$ display value.)

[Setting example] Checking the remote SV input value

Display	Operating procedure
	<p>1. Press and hold the [SEL] key for 5 seconds. <i>P-n l</i> will be displayed in the PV display section.</p>
	
	<p>2. Press the [V] key to display $r\ 5\bar{u}$. The remote SV input value is displayed in the SV display section.</p>
	<p>3. To display the operation status, press and hold the [SEL] key for 2 seconds.</p>

dSP 1 to **dSP9**

dP 10 to **dP 13**







Parameter display mask (Setting range: 0 to 255)

[Description]

- This parameter skips the parameter display by items.
- This parameter is used not to display the items that are not used, or not to change the settings mistakenly.
- “Parameter mask DSP” in “2-1 Parameter list” (pages 7 to 11) shows which parameter is skipped by setting **dSP 1** to **dSP9** and **dP 10** to **dP 13**.
- Set the total value of the item codes that you want to skip.

[Setting example 1] Skipping “I” and “d”

Setting “4+8=12” according to the code table of dSP3

Display	Operating procedure
 	1. Press and hold the [SEL] key for five seconds. <i>P-n I</i> will be displayed on the PV display.
	2. Press the [V] key to display dSP3 .
	3. Press the [SEL] key once. The current setting (0) flashes on the SV display.
	4. Press the [<] or [>] keys to display 12 .
	5. Press the [SEL] key once. 12 will stop flashing and will be registered for dSP3 . After that, the parameters of I and d will be skipped, and will not be displayed.
	6. If you want to display the operation status, press and hold the [SEL] key for two seconds.

[Setting example 2] Extinguishing the PV display

Reducing 64 from parameter dP13

Operating procedure
1. Display parameter dP 13 .
2. Check a currently displayed value of dP 13 and reduce 64 from the value. (Example: When a value of dP 13 is 127, 127-64=63).
3. Re-set the result of calculation obtained from Step 2 to dP 13 . (Example: Set 63 to dP 13).

[Setting example 3] Displaying the PV display (factory default)

Adding 64 to a value of parameter dP13

Operating procedure
1. Display parameter dP 13 .
2. Check a currently displayed value of dP 13 and add 64 to the value. (Example: When a value of dP 13 is 63, 63+64=127).
3. Re-set the result of calculation obtained from Step 2 to dP 13 . (Example: Set 127 to dP 13).

3 Troubleshooting

This section explains the judgments and remedies for problems.

Symptoms	Possible causes	Remedies	Reference pages
1. The display has shown <i>UUUU</i> or <i>LLLL</i> .	① The setting of $P-nZ$ is not correct for the input signals of sensors or others.	Set the parameter of $P-nZ$ correctly.	Page 39
	② The polarity of the sensor does not match that of the PXR.	Correct the polarity of the sensor and the PXR.	Page 57
	③ Input terminals are short-circuited in thermocouple B or R. ($P-nZ = 4, 5$)	Set the parameter of $P-nZ$ to 3, and check if the temperature around an ordinary temperature is displayed. (Thermocouples B and R have a large error around ordinary temperatures. However, this is not a fault.)	Page 39
	④ The input signals of sensors or others do not match those of the controller you use.	Ask to make adaptations on your model. Or replace your model with a new one.	-
	⑤ The connecting cables for the sensor are loose.	Tighten the connecting cables.	-
	⑥ A break or short-circuit occurred in the sensor.	Replace the sensor with a new one. Or remove the short-circuit.	-
	⑦ The sensor or other input devices that are connected to the PXR have problems.	Replace the sensor or other input devices with new ones.	-
	⑧ The set value of the parameter of $P-SL$ is larger than the value of $P-SU$.	Set the parameters again so that the value of $P-SL$ is smaller than the value of $P-SU$.	Page 40
	⑨ The measured value is too large or too small.	Set the parameters again so that the difference of the set values of $P-SL$ and $P-SU$ is made larger.	Page 40
2. <i>Err</i> has been displayed.	① The value of $P-SU$ is set to 3277°C or more for thermocouple and resistance bulb input.	Set the parameters of $P-SL$ and $P-SU$ again according to the input range table.	Page 40
	② The measured range ($P-SU$ to $P-SL$) is set to 10000 or more for voltage and current input.	Set the parameters of $P-SL$ and $P-SU$ again so that the measured range is 9999 or less.	Page 40
3. A decimal point has not been displayed.	"0" is set in the parameter of $P-dP$.	Set the parameter of $P-dP$ to "1" or "2".	Page 42
4. The SV or the set values of some parameters have been changed without any operation.	① The parameter of $P-SL$, $P-SU$, or $P-dP$ was changed.	Set all the parameters again. (When the set values of the parameters of $P-SL$, $P-SU$, and $P-dP$ are changed, the set value of each parameter for which "*" is marked with the page 5 to 8 of the Parameter list, are changed.)	Page 40 Page 7 to 11
	② When the set value of $P-SU$ is larger than 1000, "1" is registered for $P-dP$.	Set $P-dP$ to "0", and return $P-SU$ to an original value.	Page 40
5. ON/OFF control (Two-position control) has not started.	0.0 is not set in the parameter of P .	Set the parameter of P to 0.0.	Page 24
6. ON/OFF control has not function properly.	① The set value of parameter <i>HY5</i> is not correct.	Adjust the set value of parameter <i>HY5</i> to be suitable for the device to be controlled.	Page 27
	② The setting of parameter <i>onof</i> is not correct.	Set the parameter <i>onof</i> correctly.	Page 36
7. The Micro-controller is not controlling properly.	① The set values of the parameters P , \bar{L} , and d are not correct.	Perform the auto-tuning.	Page 20
	② The cycle times are too long.	Decrease the set value of the parameters fL and $fL2$ gradually.	Page 37
	③ Output is limited.	Set the parameters of $PLC1$, $PHC1$, $PLC2$, and $PHC2$ again to be suitable for the process.	Page 62
	④ Output is not limited correctly.	Set the parameters of $PCUR$ again to be suitable for the process.	Page 63

Symptoms	Possible causes	Remedies	Reference pages
8. Response is too slow. (The measured value changes slowly.)	Input filter constant is too large.	Decrease the set value of the parameter of $P-dF$.	Page 45
9. Output changes between ON and OFF, but the reading does not change.	① Some input terminals are short-circuited.	Remove the short-circuited terminals.	-
	② The connecting cable for the device to be controlled are not connected properly.	Connect it properly.	-
	③ The device to be controlled has powered off.	Power it on.	-
	④ The output signals of the Micro-controller do not match the input signals of the device to be controlled.	Prepare the Micro-controller to be suitable for the device to be controlled. Or select the device to be controlled to be suitable for the Micro-controller.	-
10. The keys do not operate. The set value of the parameters cannot be changed.	"1", "2", "4", or "5" is set in the parameter of LoC .	Set the parameter of LoC to "0" or "3".	Page 23
11. The SV cannot be changed.	① "1", or "4" is set in the parameter of LoC .	Set the parameter of LoC to "0", "2", "3" or "5".	Page 23
	② You have tried to set the value that is outside of the SV limiter (Parameters of $S\bar{u}-L$ to $S\bar{u}-H$).	Widen the range of $S\bar{u}-L$ to $S\bar{u}-H$. (However, it should be within the set range in the input range table.)	Page 54
	③ You have tried to change the SV during ramp-soak operation (rUn , Hld , or End is selected.)	Set the parameter of $ProG$ to OFF .	Page 18
12. The parameters you want to confirm or change are not displayed.	The concerned parameters are set to skip in the parameters of $dSP1$ to $dP13$.	Change the set value of the concerned dSP.	Page 78
13. Auto-tuning does not work properly.	① After starting the auto-tuning operation, the display has showed $UUUU$ or $LLLL$.	Set the parameters again so that the difference of the set values of $P-SL$ and $P-SU$ is made larger, and perform the auto-tuning again.	Page 40
	② You have changed the SV after starting the auto-tuning operation.	Set the desirable SV, and perform the auto-tuning again.	-
	③ The response of the controlled device was too fast.	Use a controller whose control cycle is fast, such as PYH.	-
	④ You have tried to perform the auto-tuning during ramp-soak operation.	Set the parameter of $ProG$ to OFF , and perform the auto-tuning again.	Page 18
	⑤ Peripheral devices have problems. Or they are not connected properly.	Connect them properly.	Page 57
	⑥ Direct/reverse actions are not suitable for the operations of the device to be controlled.	Set the parameter of $P-nI$ properly.	Page 53
	⑦ The response of the controlled device was too slow, and the auto-tuning did not finish in 9 hours.	Perform the tuning manually. (Set the parameter of P to "0" to try the ON/OFF control in a hurry.)	Page 24
14. An excessive overshoot has occurred during auto-tuning operation.	-	(1) Perform the auto-tuning with the parameter of RF being "2" (Low PV type).	Page 20
	-	(2) Perform the tuning manually.	Page 24
15. The self-tuning does not work properly.	See the section of the parameter of $CFrL$.		Page 31
16. The PV display disappeared.	The set value of parameter $dP13$ is not proper.	See the page of parameter $dP13$.	Page 78

Index

A	Adjusting the PV display (0%)	66	P	Parameter display mask	78
	Adjusting the PV display (100%)	66		Parameter functions and method of settings	14
	Alarm codes	47		Parameter list	7
	Alarm types	46		Parity for communication	71
	Anti-reset windup	30		Part names and functions	6
	Auto-tuning function	20		Power-on start	51
B	Basic operations	12		Proportional band	24
C	Calibrating the input	66		PV (Measured value) offset	43
	Canceling the alarm latch	19		PV (Measured value) stable range	35
	Cold junction compensation	65	R	Ramp-soak control	18
	Communication protocol setting	72		Ramp-soak modes	50
	Contact output	37		Ramp-soak status display	50
	Control algorithm	31		Range alarm	47
	Cooling side proportional band shift	29		RCJ (Cold junction compensation)	65
	Cooling side proportional coefficient	28		Remote SV input	75
	Current detector input	57		Remote SV input filter constant	76
	Cycle time of control output 1	37		Remote SV input value display	77
	Cycle time of control output 2 (Cooling-side)	38		Re-transmission base scale	74
D	Dead band	29		Re-transmission output type setting	73
	Decimal point position	42		Re-transmission span scale	74
	De-energized output alarm	60		Reverse action	53
	Derivative time	26	S	Selecting ramp-soak patterns	49
	DI1 operation setting	67		Selection °C / °F	40
	Direct action	53		Self-tuning	32
	Displaying On-delay alarm or the remaining time of timers	21		Setting alarm 1, 2 and 3	22
	Displaying the current input value	57		Setting the measuring range (Input range)	40
	Displaying the output value	64		Setting the ramp segment time	50
	Dual output	28		Setting the soak segment time	50
E	Error display alarm	60		Specifying control action and output direction at input burn-out	53
H	HB (Set value of heater break alarm)	57		Standby settings	16
	HYS (Hysteresis) mode at ON/OFF control	36		Station No. for communication	70
	Hysteresis alarm 1, 2 and 3	59		SV (Setting value) lower limiter	54
	Hysteresis operation	36		SV (Setting value) offset	44
	Hysteresis range for ON/OFF control	27		SV (Setting value) upper limiter	54
I	Input signal code	39		Switching the parameters	12
	Integral time	25	T	The time of ON-delay alarm or timer function	55
K	Key lock	23		Time constant of input filter	45
L	Local/remote operation setting	17		Timer code	47
	Low PV type	20		Troubleshooting	79
	Lower limit alarm	47	U	Upper and lower limits for control output 1	62
	Lower limit of alarm 1, 2 and 3	22		Upper and lower limits for control output 2	62
M	Method of setting the SV (setting value)	14		Upper limit alarm	47
	Manual mode setting	15		Upper limit of alarm 1, 2 and 3	22
O	ON/OFF control (two-position control)	24		User settings	66
	Operation methods	7			
	Options of alarm 1, 2 and 3	60			
	Output direction at input burn-out	53			
	Output limit types	63			
	Output offset value	30			
	Overlap band	29			

Memo

Safety Precaution

- Before using the PXR, read the “Instruction Manual” or consult with your local distributor or Fuji Electric for safety purpose.
- The uses and places for some of equipment described in this manual are limited. Some devices need regular inspections. Consult with your local distributor or Fuji Electric.
- Only electricians should connect this equipment.
- The contents of this manual have been prepared carefully. However, it should be noted that Fuji Electric is not responsible for any loss, including consequential damage from errors in writing or missing information.
Before operating the PXR, carefully read the safety precaution in the “Instruction Manual”.

Over-temperature Protection

Any control system design should take into account that any part of the system has the potential to fail.

For temperature control systems, continued heating should be considered the most dangerous condition, and the machine should be designed to automatically stop heating if unregulated due to the failure of the control unit or for any other reason.

The following are the most likely causes of unwanted continued heating:

- 1) Controller failure with heating output constantly on
- 2) Disengagement of the temperature sensor from the system
- 3) A short circuit in the thermocouple wiring
- 4) A valve or switch contact point outside the system is locked to keep the heat switched on.

In any application where physical injury or destruction of equipment might occur, we recommend the installation of independent safety equipment, with a separate temperature sensor, to disable the heating circuit in case of overheating.

The controller alarm signal is not designed to function as a protective measure in case of controller failure.

[Note] Modbus™ is a trademark of Modicon.
Ciltect™ is a trade mark of CI Technology.

Consult on the PXR with the following:

Fuji Electric Systems Co., Ltd.

Head Office

Gate City Ohsaki, East Tower, 11-2, Osaki 1-chome,
Shinagawa-ku, Tokyo 141-0032, Japan
<http://www.fesys.co.jp/eng>

Instrumentation Div. International Sales Dept.

No.1, Fuji-machi, Hino-city, Tokyo, 191-8502 Japan
Phone: 81-42-585-6201, 6202 Fax: 81-42-585-6187
<http://www.fic-net.jp/eng>

Information in this catalog is subject to change without notice.

Printed in Japan