

NOTES:

- 1. Material : Stainless St
- 2. Finish : Zinc - Z
- 3. Sugg. Max. Deflection : 1891.000 Deg
- 4. Sugg. Max. Torque : 0.150 (in-lbs)
- 5. Total Coils : 4.000
- 6. Sugg. Mandrel Diameter : 0.160 (in)
- 7. All Drawing Dimensions are in Inches [mm]

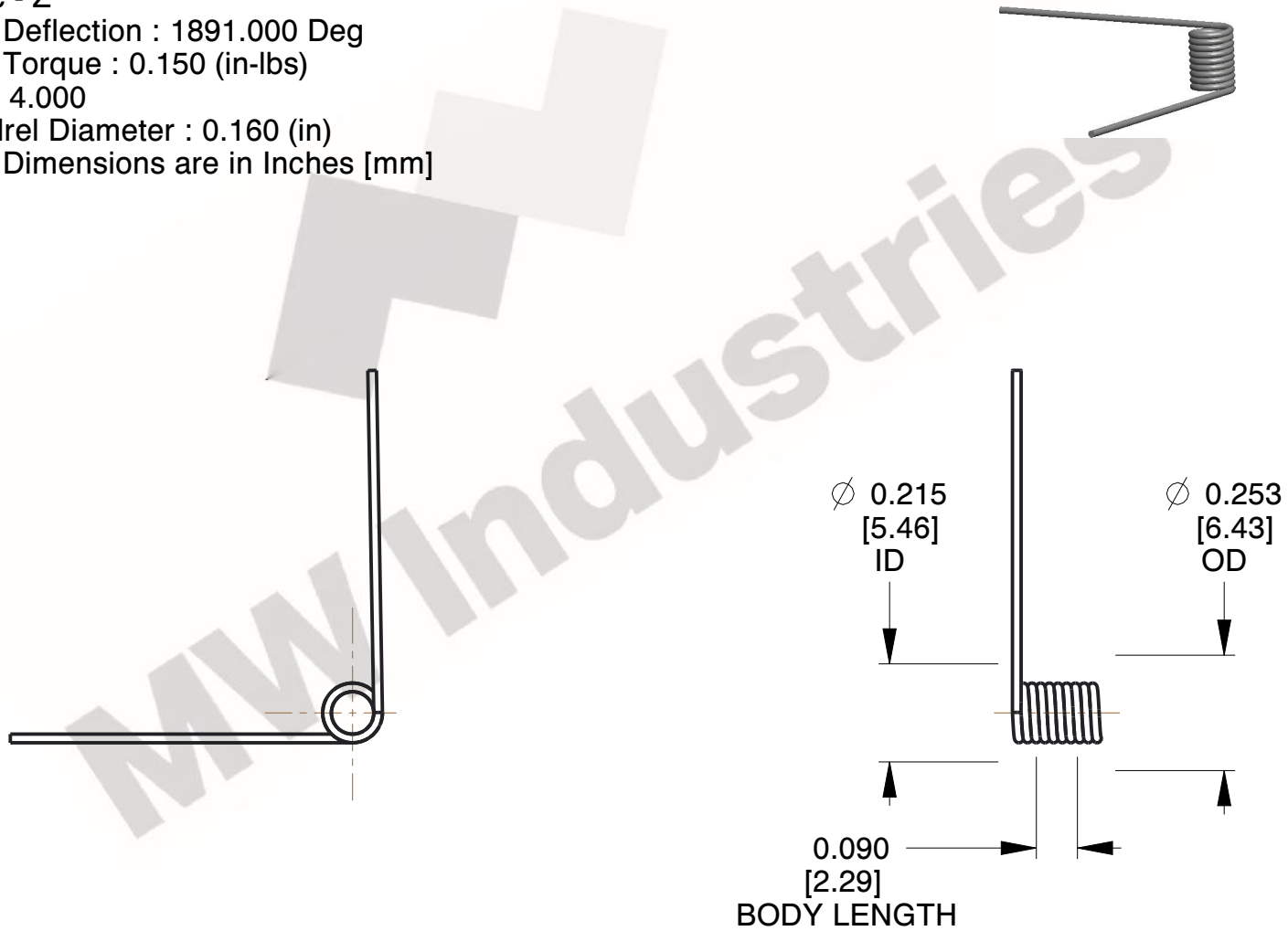

COMPONENT		TORSION SPRINGS	
TO-1114		UNIT	
		INCH [mm]	
		SHEET	
TORSION SPRINGS		1 of 1	