



# AMP & ELCON Power Connector Layout Forms

RoHS  
Ready 

 **Tyco Electronics**  
Our commitment. Your advantage.

**Table of Contents**

**Disclaimer**

While Tyco Electronics Corporation and its affiliates referenced herein ("Tyco Electronics") have made every reasonable effort to ensure the accuracy of the information in this catalog, Tyco Electronics does not guarantee that it is error-free, nor does Tyco Electronics make any other representation, warranty or guarantee that the information is accurate, correct, reliable or current.

Tyco Electronics reserves the right to make any adjustments to the information contained herein at any time without notice. Tyco Electronics expressly disclaims all implied warranties regarding the information contained herein, including, but not limited to, any implied warranties of merchantability or fitness for a particular purpose. Tyco Electronics' only obligations are those in the Tyco Electronics Standard Terms and Conditions of Sale, and in no case will Tyco Electronics be responsible for any incidental, indirect, or consequential damages arising from the sale, resale, use, or misuse of its products. Users should independently evaluate the suitability of, and test each product for, their application.

The dimensions, specifications, designs, construction, materials and processes in this catalog are for reference purposes only and are subject to change without notice. Please consult Tyco Electronics for the most current product information.

The export of certain Tyco Electronics products is restricted by the Arms Export Control Act (Title 22, U.S.C. Sec 2751, et seq.) or the Export Administration Act of 1979, as amended (Title 50, U.S.C., App. 2401 et seq.). Orders may be subject to export approval by the U.S. Government. Buyer must comply with all applicable export laws of all applicable jurisdictions.

© Copyright 2007, 2006, and 2005 by Tyco Electronics Corporation. All International Rights Reserved.

AMP, ELCON, FLATPAQ, MINIPAK, MULTI-BEAM XL, TE LOGO and TYCO ELECTRONICS are trademarks of Tyco Electronics Corporation.

Other products, logos, and company names mentioned herein may be trademarks of their respective owners.

MULTI-BEAM XL Custom Connector Worksheet . . . . . 3  
 MINIPAK Custom Connector Worksheet . . . . . 4  
 FLATPAQ Connector Layout Form . . . . . 5  
 Mini Drawer Connector Pin Side Layout Form . . . . . 6  
 Mini Drawer Connector Socket Side Layout Form . . . . . 7  
 Lower Drawer Connector Pin Side Layout Form . . . . . 8  
 Lower Drawer Connector Socket Side Layout Form . . . . . 9  
 75A Middle Drawer Connector Pin Side Layout Form . . . . . 10  
 75A Middle Drawer Connector Socket Side Layout Form . . . . . 11  
 125A Middle Drawer Connector Pin Side Layout Form . . . . . 12  
 125A Middle Drawer Connector Socket Side Layout Form . . . . . 13  
 200A Middle Drawer Connector Pin Side Layout Form . . . . . 14  
 200A Middle Drawer Connector Socket Side Layout Form . . . . . 15  
 Square Drawer Connector Pin Side Layout Form . . . . . 16  
 Square Drawer Connector Socket Side Layout Form . . . . . 17  
 Top Drawer Connector Pin Side Layout Form . . . . . 18  
 Top Drawer Connector Socket Side Layout Form . . . . . 19  
 Double Drawer Connector Pin Side Layout Form . . . . . 20  
 Double Drawer Connector Socket Side Layout Form . . . . . 21  
 DualPower Drawer Connector Pin Side Layout Form . . . . . 22  
 DualPower Drawer Connector Socket Side Layout Form . . . . . 23  
 QuadPower Drawer Connector Pin Side Layout Form . . . . . 24  
 QuadPower Drawer Connector Socket Side Layout Form . . . . . 25  
 In-Line QuadPower Drawer Connector Pin Side Layout Form . . . . . 26  
 In-Line QuadPower Drawer Connector Socket Side Layout Form . . . . . 27  
 W5 Power Drawer Connector Pin Side Layout Form . . . . . 28  
 W5 Power Drawer Connector Socket Side Layout Form . . . . . 29  
 HV8P Drawer Connector Pin Side Layout Form . . . . . 30  
 HV8P Drawer Connector Socket Side Layout Form . . . . . 31  
 P10S0 Drawer Connector Pin Side Layout Form . . . . . 32  
 P10S0 Drawer Connector Socket Side Layout Form . . . . . 33  
 P10S22 Drawer Connector Pin Side Layout Form . . . . . 34  
 P10S22 Drawer Connector Socket Side Layout Form . . . . . 35  
 P12S12 Drawer Connector Pin Side Layout Form . . . . . 36  
 P12S12 Drawer Connector Socket Side Layout Form . . . . . 37  
 P0S30 Drawer Connector Pin Side Layout Form . . . . . 38  
 P0S30 Drawer Connector Socket Side Layout Form . . . . . 39

**Restriction on the use of Hazardous Substances (RoHS)**

At Tyco Electronics, we're ready to support your RoHS requirements. We've assessed more than 1.5 million end items/components for RoHS compliance, and issued new part numbers where any change was required to eliminate the restricted materials. Part numbers in this catalog are identified as:

**RoHS Compliant** — Part numbers in this catalog are RoHS Compliant, unless marked otherwise. These products comply with European Union Directive 2002/95/EC as amended 1 January 2006 that restricts the use of lead, mercury, cadmium, hexavalent chromium, PBB, and PBDE in certain electrical and electronic products sold into the EU as of 1 July 2006.

NOTE: For purposes of this Catalog, included within the definition of RoHS Compliant are products that are clearly "Out of Scope" of the RoHS Directive such as hand tools and other non-electrical accessories.

NOTE: Information regarding RoHS compliance is provided based on reasonable inquiry of our suppliers and represents our current actual knowledge based on the information provided by our suppliers. This information is subject to change. For latest compliance status, refer to our website referenced at right.

**Getting the Information You Need**

Our comprehensive on-line RoHS Customer Support Center provides a forum to answer your questions and support your RoHS needs. A RoHS FAQ (Frequently Asked Questions) is available with links to more detailed information. You can also submit RoHS questions and receive a response within 24 hours during a normal work week. The Support Center also provides:

- Cross-Reference from Non-compliant to Compliant Products
- Ability to browse RoHS Compliant Products in our on-line catalog
- Downloadable Technical Data Customer Information Presentation
- More detailed information regarding the definitions used above
- So whatever your questions when it comes to RoHS, we've got the answers at [www.tycoelectronics.com/leadfree](http://www.tycoelectronics.com/leadfree)





## MINIPAK Custom Connector Worksheet

### MINIPAK Connector

- a. Enter your information in the table to the right.
- b. Specify the design requirements for your MINIPAK Connector configuration in steps 1 through 5 shown below.
- c. Sign, date and send the completed form to your local Tyco Electronics Sales Engineer.

Tyco Electronics will recommend a MINIPAK Connector configuration based on the specified requirements and issue a Customer Drawing for your approval.

**This drawing will have a unique Part Number specific to your configuration, which you should reference whenever you make an inquiry or place an order.**

ENTER CUSTOMER INFORMATION	
Company	Location
Contact Name	Title
Telephone	Fax
Email Address	
I am: <input type="checkbox"/> End user <input type="checkbox"/> Contract manufacturer (end user: _____)	
Signature	Today's Date
	Annual Quantity Required

### 1. AC INPUT

- No AC input required       125 VAC spacing       250 VAC spacing

### 2. SIGNAL CONTACTS

- No signal contacts required     6 contacts     24 contacts     30 contacts     Other: \_\_\_\_\_
- Signal sequencing required (two pin lengths available; write requirements under NOTES below.)

### 3. DC INPUT/OUTPUT

Write the current, voltage and sequencing requirements for each of the DC lines required by your application. Tyco Electronics will use this information to configure the DC side of your MINIPAK Connector with the appropriate number of contacts and contact spacing.

DC Requirements									
		DC1	DC2	DC3	DC4	DC5	DC6	DC7	DC8
<b>Current (A)</b>									
<b>Voltage (V)</b>									
<b>Blade Length</b>	<b>Standard</b>								
	<b>Premate</b>								

### 4. BOARD MOUNTING STYLE

**Straight Socket** (choose one)

- Short solder tail (.062" thick boards)
- Long solder tail (.093/.125" thick boards)
- Compliant press-fit tails (.093" min. thick board recommended)

**Right Angle Blade** (choose one)

- Short solder tail (for .062" thick boards)
- Long solder tail (.093/.125" thick boards)

### 5. OTHER REQUIREMENTS

- Alignment guides required
- Connector length restriction, if any: \_\_\_\_\_ " (\_\_\_\_\_ mm)

For further clarity, you can attach a sketch to this form if necessary.

- Sketch attached: \_\_\_\_\_ pages

### NOTES:

---

---

---

---

---

---

---

---

---

---

AMP, ELCON, MINIPAK, TE LOGO and TYCO ELECTRONICS are trademarks of Tyco Electronics Corporation.



## FLATPAQ Connector Layout Form

### Instructions

1. Indicate the connector layout by filling in the FP number of each module required in the boxes, one per box. Use one form per mated pair.
2. Left to right order of the modules should match **mating face views** of the connector. **When laying out right angle assemblies**, make sure you look at the mating face with the termination tails facing downwards.
3. **For solder terminated assemblies**, indicate the tail length for each half of the connector using the checkboxes to the right of the layout grid.
4. Sign, date and send the completed form to your local Tyco Electronics Sales Engineer.

Upon receipt of this form, Tyco Electronics will generate a Customer Drawing for you to check and approve prior to connector production.

ENTER CUSTOMER INFORMATION	
Company	Location
Contact Name	Title
Telephone	Fax
Email Address	
I am: <input type="checkbox"/> End user <input type="checkbox"/> Contract manufacturer (end user: )	
Signature	Today's Date
Annual Quantity Required	

Write the "FP" numbers to indicate the layout of one half of the connector assembly, matching the left to right order with the mating face view of the connector (right angle assembly tails facing downwards).

FP	FP	FP	FP	FP	FP	FP	FP	FP	FP	FP	FP	FP	FP	<b>Solder Tail Options</b> <input type="checkbox"/> .115" (2.9 mm); .062" thick boards <input type="checkbox"/> .177" (4.5 mm); .093/.125" boards

Write the "FP" numbers to indicate the layout of the mate of the above assembly, matching the left to right order with the mating face view of the connector (right angle assembly tails facing downwards).

FP	FP	FP	FP	FP	FP	FP	FP	FP	FP	FP	FP	FP	FP	<b>Solder Tail Options</b> <input type="checkbox"/> .115" (2.9 mm); .062" thick boards <input type="checkbox"/> .177" (4.5 mm); .093/.125" boards

### Right Angle Mount

#### 250 V Power Modules

FP151 Standard Blade FP105 Float, Standard FP205 Hot Plug, Press-fit	FP152 Premate Blade FP106 Float, Premate FP206 Hot Plug, Press-fit	FP153 Postmate Blade FP107 Float, Postmate FP207 Hot Plug, Press-fit	FP104 Hot Plug Socket FP204 Hot Plug, Press-fit	FP512 Spacer, 250 V

#### Signal Modules

FP302 24-Pin FP402 24-Pin, Press-fit	FP303 24-Pin Socket FP403 24-Pin, Press-fit	FP314 6-Pin FP414 6-Pin, Press-fit	FP315 6-Pin Socket FP415 6-Pin, Press-fit

#### 600 V Power Modules

FP155 Standard Blade FP121 Float, Standard FP221 Hot Plug, Press-fit	FP156 Premate Blade FP122 Float, Premate FP222 Hot Plug, Press-fit	FP157 Postmate Blade FP123 Float, Postmate FP223 Hot Plug, Press-fit	FP120 Hot Plug Socket FP220 Hot Plug, Press-fit	FP514 Spacer, 600 V

#### Mounts

FP500 Left Flange Mount	FP501 Right Flange Mount

#### Guides

Right Angle Guide Sockets FP506 Passive FP516 Active	FP507 Right Angle Passive Guide Pin

### Straight Mount

#### 250 V Power Modules

FP150 Socket, Solder FP250 Socket, Press-fit FP100 Hot Plug, Solder FP200 Hot Plug, Press-fit	FP161 Standard Blade FP101 Float, Standard FP201 Hot Plug, Press-fit	FP162 Premate Blade FP102 Float, Premate FP202 Hot Plug, Press-fit	FP163 Postmate Blade FP103 Float, Postmate FP203 Hot Plug, Press-fit	FP511 Spacer, 250 V

#### Signal Modules

FP300 24-Pin FP400 24-Pin, Press-fit	FP318 24-Pin Socket FP418 24-Pin Skt, Press-fit FP301 24-Pin Skt, 3A Rated FP401 24-Pin Skt, 3A, Press-fit	FP312 6-Pin FP412 6-Pin, Press-fit	FP313 6-Pin Socket, 3A rated FP413 6-Pin Skt, 3A, Press-fit

#### 600 V Power Modules

FP154 Socket, Solder FP254 Socket, Press-fit FP116 Hot Plug, Solder FP216 Hot Plug, Press-fit	FP165 Standard Blade FP117 Float, Standard FP217 Hot Plug, Press-fit	FP166 Premate Blade FP118 Float, Premate FP218 Hot Plug, Press-fit	FP167 Postmate Blade FP119 Float, Postmate FP219 Hot Plug, Press-fit	FP513 Spacer, 600 V

#### Mounts

FP500 Left Flange Mount	FP501 Right Flange Mount

#### Guides

FP502 Straight Passive Guide Socket	Straight Guide Pins FP503 Passive FP515 Active, M3 FP517 Active, 4-40

**Note:** All modules are solder tail termination unless indicated as compliant Press-fit. Select solder tail length using check boxes to the right of the connector layout grid above. 0.093" or thicker boards are recommended for compliant Press-fit termination style. Consult Tyco Electronics for signal module sequencing. See Catalog 1773096 for benefits of Hot Plug and Float options.

AMP, ELCON, FLATPAQ, TE LOGO and TYCO ELECTRONICS are trademarks of Tyco Electronics Corporation.

## Mini Drawer Connector Pin Side Layout Form

### Pin Assembly

1. Choose one housing from the **Pin Housing Selection Menu** table.
2. Write the total quantity of each pin contact you require **for each pin assembly** in the **Qty** column of the **Pin Contact Selection Menu** table.
3. Crimp contacts are shipped uninstalled. PCB tail contacts are installed by Tyco Electronics; enter the letter reference of the desired PCB tail contact in the appropriate contact positions on the drawing: e.g., if you need a size #20 premate PCB tail contact to be installed in contact position #10, write "E" in circle #10.
4. Sign, date and send the completed form to your local Tyco Electronics Sales Engineer.

ENTER CUSTOMER INFORMATION	
Company	Location
Contact Name	Title
Telephone	Fax
Email Address	
I am: <input type="checkbox"/> End user <input type="checkbox"/> Contract manufacturer (end user: _____)	
Signature	Today's Date
	Annual Quantity Required

Submit to your local Tyco Electronics Sales Engineer.

**Pin Connector (Rear Face)**  
Pin Contact Insertion Side  
Pin Connector Rear Face Cavity Identification

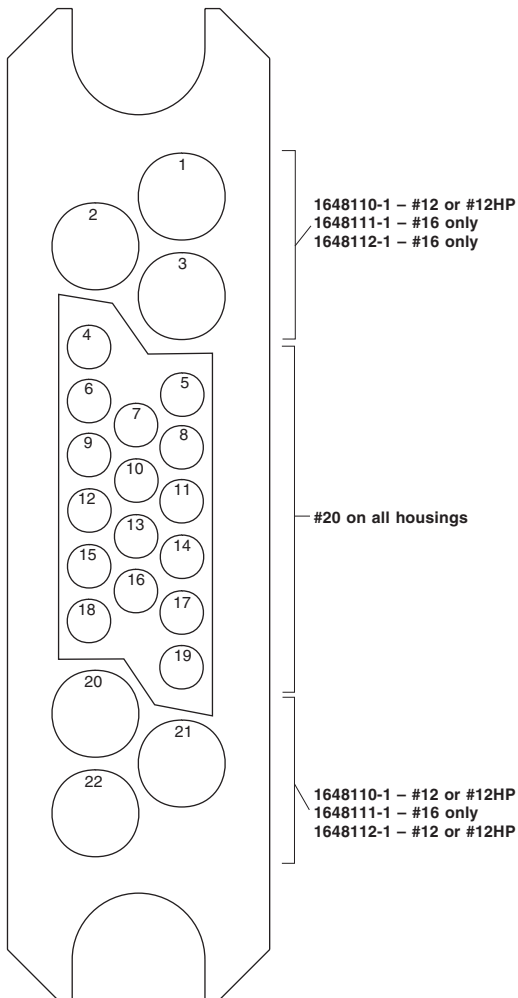

Pin Housing Selection Menu		Check One
Part Number	Description	
1648110-1	#12, #20, #12 Pin Housing, Float or Fixed Mounting	<input type="checkbox"/>
1648111-1	#16, #20, #16 Pin Housing, Float or Fixed Mounting	<input type="checkbox"/>
1648112-1	#16, #20, #12 Pin Housing, Float or Fixed Mounting	<input type="checkbox"/>

Pin Contact Selection Menu				
Size	Ref.	Part Number	Termination Style & Pin Length	Qty.
#20	A =	1650155-1	Crimp, standard	
	B =	1650161-1	Crimp, premate	
	C =	1650162-2	Crimp, postmate	
	D =	1650283-1	PCB tail, standard	
	E =	1650065-1	PCB tail, premate	
	F =	1650226-1	PCB tail, postmate	
#16	G =	1766194-1	Crimp, standard	
	H =	1766198-1	Crimp, premate	
	J =	1766199-1	Crimp, postmate	
	K =	1766222-1	PCB tail, standard	
	L =	1766223-1	PCB tail, premate	
	M =	1766818-1	PCB tail, postmate	
#12	N =	1766193-1	Crimp, standard	
	P =	1766195-1	Crimp, premate	
	Q =	1766196-1	Crimp, postmate	
	R =	1766245-1	PCB tail, standard	
	S =	1766250-1	PCB tail, premate	
	T =	1766249-1	PCB tail, postmate	
#12 Hot Plug	U =	1650153-2	Crimp, standard, Hot Plug	
	V =	1650156-2	Crimp, premate, Hot Plug	
	W =	1650060-2	PCB tail, standard, Hot Plug	
	X =	1650074-3	PCB tail, premate, Hot Plug	

Crimp contacts are removable. PCB tail contacts are non-removable.

Float Mount Shoulder Screw		
Part Number	Description	Qty.
1650402-1	Screw, No 8-32 UNC 2A	
1650106-1	Screw, No 6-32 UNC 2A	
1650589-1	Screw, M4 x 0.7	

**Top Assembly Part Number Assigned by Tyco Electronics**

AMP, ELCON, TE LOGO and TYCO ELECTRONICS are trademarks of Tyco Electronics Corporation.

## Mini Drawer Connector Socket Side Layout Form

### Socket Assembly

1. Choose one housing from the **Socket Housing Selection Menu** table.
2. Write the total quantity of each socket contact you require for each **socket assembly** in the **Qty** column of the **Socket Contact Selection Menu** table.
3. Crimp contacts are shipped uninstalled. PCB tail contacts are installed by Tyco Electronics; enter the letter reference of the desired PCB tail contact in the appropriate contact positions on the drawing: e.g., if you need a size #20 PCB tail contact to be installed in contact position #8, write "C" in circle #8.
4. Sign, date and send the completed form to your local Tyco Electronics Sales Engineer.

ENTER CUSTOMER INFORMATION	
Company	Location
Contact Name	Title
Telephone	Fax
Email Address	
I am: <input type="checkbox"/> End user <input type="checkbox"/> Contract manufacturer (end user: _____)	
Signature	Today's Date
	Annual Quantity Required

Submit to your local Tyco Electronics Sales Engineer.

**Socket Connector (Rear Face)**  
Socket Contact Insertion Side  
Socket Connector Rear Face Cavity Identification

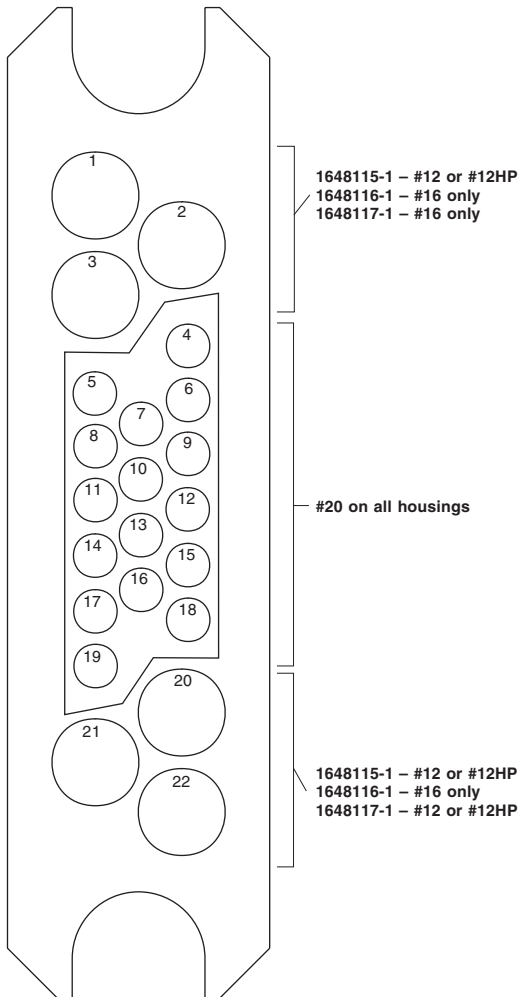

Socket Housing Selection Menu		Check One
Part Number	Description	
1648115-1	#12, #20, #12 Socket Housing, Float or Fixed Mounting	
1648116-1	#16, #20, #16 Socket Housing, Float or Fixed Mounting	
1648117-1	#16, #20, #12 Socket Housing, Float or Fixed Mounting	

Socket Contact Selection Menu				
Size	Ref.	Part Number	Termination Style	Qty.
#20	A =	1648325-1	Crimp	
	B =	6648301-1	Compliant Press-fit	
	C =	1648382-1	PCB Tail	
#16	D =	6648319-1	Crimp	
	E =	6648306-1	Compliant Press-fit	
	F =	6648383-1	PCB Tail	
#12	G =	6648318-1	Crimp	
	H =	6648304-1	Compliant Press-fit	
	J =	6648374-1	PCB Tail	
#12 Hot Plug	K =	1648384-1	Crimp, Hot Plug	
	L =	6648305-1	Compliant Press-fit, Hot Plug	
	M =	1648387-1	PCB Tail, Hot Plug	

Crimp contacts are removable. Press-fit and PCB tail contacts are non-removable.

Float Mount Shoulder Screw		
Part Number	Description	Qty.
1650402-1	Screw, No 8-32 UNC 2A	
1650106-1	Screw, No 6-32 UNC 2A	
1650589-1	Screw, M4 x 0.7	

**Top Assembly Part Number Assigned by Tyco Electronics**

AMP, ELCON, TE LOGO and TYCO ELECTRONICS are trademarks of Tyco Electronics Corporation.

## Lower Drawer Connector Pin Side Layout Form

### Pin Assembly

1. Choose one housing from the **Pin Housing Selection Menu** table.
2. Write the total quantity of each pin contact you require for each pin assembly in the **Qty** column of the **Pin Contact Selection Menu** table.
3. Crimp contacts are shipped uninstalled. PCB tail contacts are installed by Tyco Electronics; enter the letter reference of the desired PCB tail contact in the appropriate contact positions on the drawing: e.g., if you need a size #20 premate PCB tail contact to be installed in contact position #10, write "E" in circle #10.
4. Sign, date and send the completed form to your local Tyco Electronics Sales Engineer.

ENTER CUSTOMER INFORMATION	
Company	Location
Contact Name	Title
Telephone	Fax
Email Address	
I am: <input type="checkbox"/> End user <input type="checkbox"/> Contract manufacturer (end user: _____)	
Signature	Today's Date
	Annual Quantity Required

Submit to your local Tyco Electronics Sales Engineer.

**Pin Connector (Rear Face)**  
Pin Contact Insertion Side  
Pin Connector Rear Face Cavity Identification

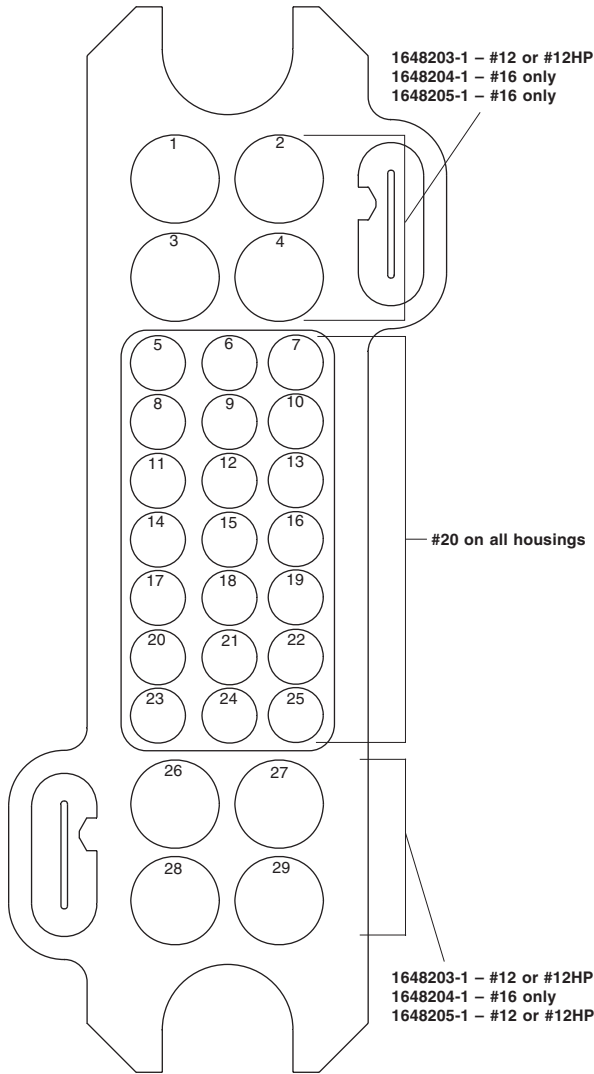

**Top Assembly Part Number Assigned by Tyco Electronics**

Pin Housing Selection Menu		Check One
Part Number	Description	
1648203-1	#12, #20, #12 Pin Housing, Float or Fixed Mounting	
1648204-1	#16, #20, #16 Pin Housing, Float or Fixed Mounting	
1648205-1	#16, #20, #12 Pin Housing, Float or Fixed Mounting	

Pin Contact Selection Menu				
Size	Ref.	Part Number	Termination Style & Pin Length	Qty.
#20	A =	1650155-1	Crimp, standard	
	B =	1650161-1	Crimp, premate	
	C =	1650162-2	Crimp, postmate	
	D =	1650283-1	PCB tail, standard	
	E =	1650065-1	PCB tail, premate	
	F =	1650226-1	PCB tail, postmate	
#16	G =	1766194-1	Crimp, standard	
	H =	1766198-1	Crimp, premate	
	J =	1766199-1	Crimp, postmate	
	K =	1766222-1	PCB tail, standard	
	L =	1766223-1	PCB tail, premate	
	M =	1766818-1	PCB tail, postmate	
#12	N =	1766193-1	Crimp, standard	
	P =	1766195-1	Crimp, premate	
	Q =	1766196-1	Crimp, postmate	
	R =	1766245-1	PCB tail, standard	
	S =	1766250-1	PCB tail, premate	
	T =	1766249-1	PCB tail, postmate	
#12 Hot Plug	U =	1650153-2	Crimp, standard, Hot Plug	
	V =	1650156-2	Crimp, premate, Hot Plug	
	W =	1650060-2	PCB tail, standard, Hot Plug	
	X =	1650074-3	PCB tail, premate, Hot Plug	

Crimp contacts are removable. PCB tail contacts are non-removable.

Float Mount Shoulder Screw		
Part Number	Description	Qty.
1650402-1	Screw, No 8-32 UNC 2A	
1650106-1	Screw, No 6-32 UNC 2A	
1650589-1	Screw, M4 x 0.7	

AMP, ELCON, TE LOGO and TYCO ELECTRONICS are trademarks of Tyco Electronics Corporation.



## Lower Drawer Connector Socket Side Layout Form

### Socket Assembly

1. Choose one housing from the **Socket Housing Selection Menu** table.
2. Write the total quantity of each socket contact you require for each **socket assembly** in the **Qty** column of the **Socket Contact Selection Menu** table.
3. Crimp contacts are shipped uninstalled. PCB tail contacts are installed by Tyco Electronics; enter the letter reference of the desired PCB tail contact in the appropriate contact positions on the drawing: e.g., if you need a size #20 PCB tail contact to be installed in contact position #8, write "C" in circle #8.
4. Sign, date and send the completed form to your local Tyco Electronics Sales Engineer.

ENTER CUSTOMER INFORMATION	
Company	Location
Contact Name	Title
Telephone	Fax
Email Address	
I am: <input type="checkbox"/> End user <input type="checkbox"/> Contract manufacturer (end user: _____ )	
Signature	Today's Date
	Annual Quantity Required

Submit to your local Tyco Electronics Sales Engineer.

**Socket Connector (Rear Face)**  
Socket Contact Insertion Side  
Socket Connector Rear Face Cavity Identification

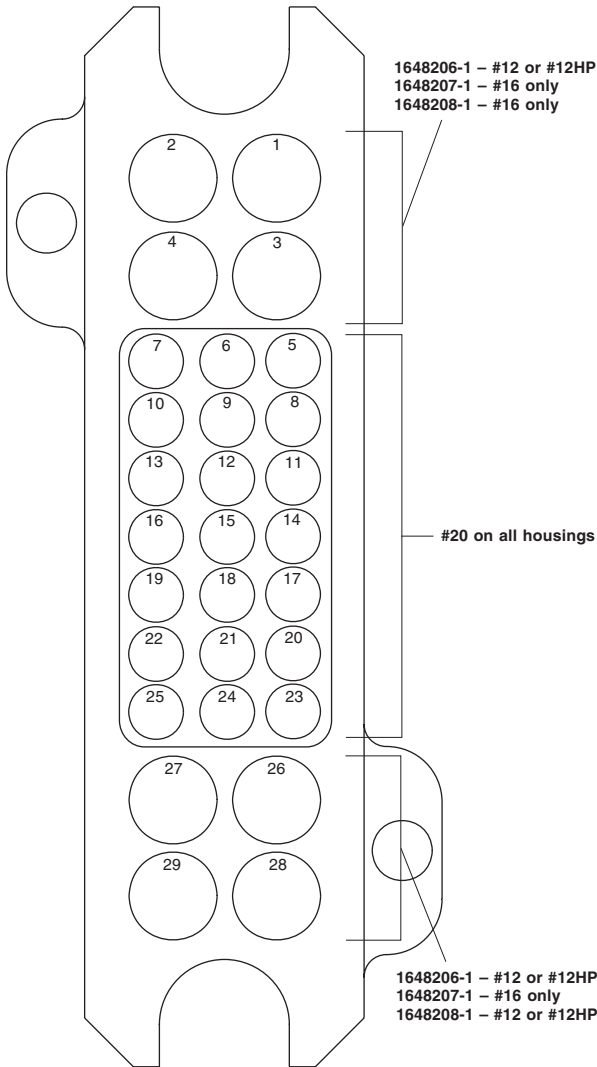

Socket Housing Selection Menu		Check One
Part Number	Description	
1648206-1	#12, #20, #12 Socket Housing, Float or Fixed Mounting	<input type="checkbox"/>
1648207-1	#16, #20, #16 Socket Housing, Float or Fixed Mounting	<input type="checkbox"/>
1648208-1	#16, #20, #12 Socket Housing, Float or Fixed Mounting	<input type="checkbox"/>

Socket Contact Selection Menu				
Size	Ref.	Part Number	Termination Style	Qty.
#20	A =	1648325-1	Crimp	<input type="checkbox"/>
	B =	6648301-1	Compliant Press-fit	<input type="checkbox"/>
	C =	1648382-1	PCB Tail	<input type="checkbox"/>
#16	D =	6648319-1	Crimp	<input type="checkbox"/>
	E =	6648306-1	Compliant Press-fit	<input type="checkbox"/>
	F =	6648383-1	PCB Tail	<input type="checkbox"/>
#12	G =	6648318-1	Crimp	<input type="checkbox"/>
	H =	6648304-1	Compliant Press-fit	<input type="checkbox"/>
	J =	6648374-1	PCB Tail	<input type="checkbox"/>
#12 Hot Plug	K =	1648384-1	Crimp, Hot Plug	<input type="checkbox"/>
	L =	6648305-1	Compliant Press-fit, Hot Plug	<input type="checkbox"/>
	M =	1648387-1	PCB Tail, Hot Plug	<input type="checkbox"/>

Crimp contacts are removable. Press-fit and PCB tail contacts are non-removable.

Float Mount Shoulder Screw		
Part Number	Description	Qty.
1650402-1	Screw, No 8-32 UNC 2A	<input type="checkbox"/>
1650106-1	Screw, No 6-32 UNC 2A	<input type="checkbox"/>
1650589-1	Screw, M4 x 0.7	<input type="checkbox"/>

**Top Assembly Part Number Assigned by Tyco Electronics**

AMP, ELCON, TE LOGO and TYCO ELECTRONICS are trademarks of Tyco Electronics Corporation.

## 75A Middle Drawer Connector Pin Side Layout Form

### Pin Assembly

1. Choose one housing from the **Pin Housing Selection Menu** table.
2. Write the total quantity of each pin contact you require **for each pin assembly** in the **Qty** column of the **Pin Contact Selection Menu** table.
3. Crimp contacts are shipped uninstalled. PCB tail contacts are installed by Tyco Electronics; enter the letter reference of the desired PCB tail contact in the appropriate contact positions on the drawing: e.g., if you need a non-hot plug size #12 premate PCB tail contact to be installed in contact position #8, write "Q" in circle #8.
4. Sign, date and send the completed form to your local Tyco Electronics Sales Engineer.

ENTER CUSTOMER INFORMATION	
Company	Location
Contact Name	Title
Telephone	Fax
Email Address	
I am: <input type="checkbox"/> End user <input type="checkbox"/> Contract manufacturer (end user: _____)	
Signature	Today's Date
	Annual Quantity Required

Submit to your local Tyco Electronics Sales Engineer.

**Pin Connector (Rear Face)**  
Pin Contact Insertion Side  
Pin Connector Rear Face Cavity Identification

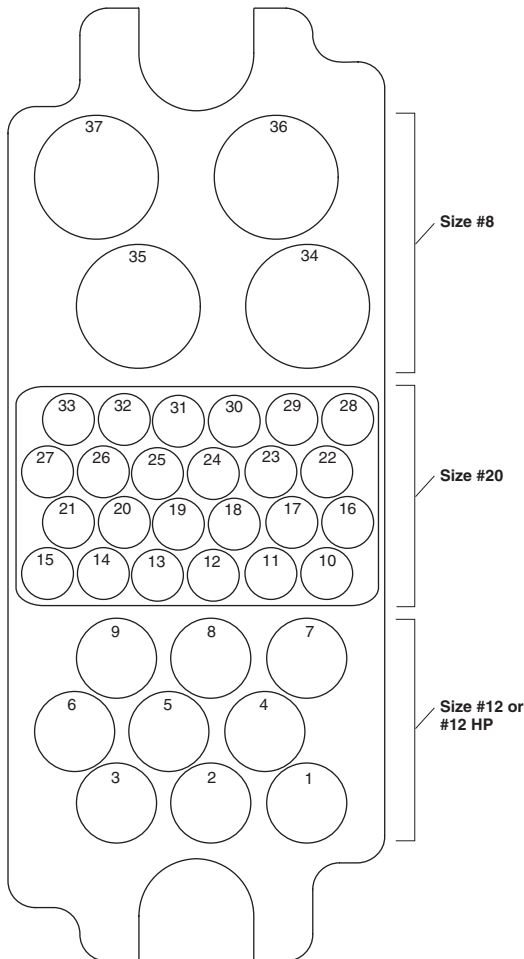

Pin Housing Selection Menu		Check One
Part Number	Description	
1648162-1	Float Mount for Crimp Contacts	
1648163-1	Flush PCB Mount for PCB Tail Contacts	

Pin Contact Selection Menu				
Size	Ref.	Part Number	Termination Style & Pin Length	Qty.
#8	A =	1766192-1	Crimp, standard	
	B =	1766197-1	Crimp, premate	
	C =	1766262-1	PCB tail, standard	
	D =	1766263-1	PCB tail, premate	
#20	E =	1650155-1	Crimp, standard	
	F =	1650161-1	Crimp, premate	
	G =	1650162-2	Crimp, postmate	
	H =	1650283-1	PCB tail, standard	
	J =	1650065-1	PCB tail, premate	
#12	K =	1650226-1	PCB tail, postmate	
	L =	1766193-1	Crimp, standard	
	M =	1766195-1	Crimp, premate	
	N =	1766196-1	Crimp, postmate	
	P =	1766245-1	PCB tail, standard	
#12 Hot Plug	Q =	1766250-1	PCB tail, premate	
	R =	1766249-1	PCB tail, postmate	
	S =	1650153-2	Crimp, standard, Hot Plug	
	T =	1650156-2	Crimp, premate, Hot Plug	
	U =	1650060-2	PCB tail, standard, Hot Plug	
	V =	1650074-3	PCB tail, premate, Hot Plug	

Crimp contacts are removable. PCB tail contacts are non-removable.

Float Mount Shoulder Screw		
Part Number	Description	Qty.
1650402-1	Screw, No 8-32 UNC 2A	
1650106-1	Screw, No 6-32 UNC 2A	
1650589-1	Screw, M4 x 0.7	

**Top Assembly Part Number Assigned by Tyco Electronics**

AMP, ELCON, TE LOGO and TYCO ELECTRONICS are trademarks of Tyco Electronics Corporation.

## 75A Middle Drawer Connector Socket Side Layout Form

### Socket Assembly

1. Choose one housing from the **Socket Housing Selection Menu** table.
2. Write the total quantity of each socket contact you require for each **socket assembly** in the **Qty** column of the **Socket Contact Selection Menu** table.
3. Crimp contacts are shipped uninstalled. Press-fit and PCB tail contacts are installed by Tyco Electronics; enter the letter reference of the contact in the appropriate contact positions on the drawing: e.g., if you need a non-hot plug size #12 PCB tail contact to be installed in contact position #8, write "J" in circle #8.
4. Sign, date and send the completed form to your local Tyco Electronics Sales Engineer.

ENTER CUSTOMER INFORMATION	
Company	Location
Contact Name	Title
Telephone	Fax
Email Address	
I am: <input type="checkbox"/> End user <input type="checkbox"/> Contract manufacturer (end user: _____)	
Signature	Today's Date
	Annual Quantity Required

Submit to your local Tyco Electronics Sales Engineer.

**Socket Connector (Rear Face)**  
Socket Contact Insertion Side  
Socket Connector Rear Face Cavity Identification

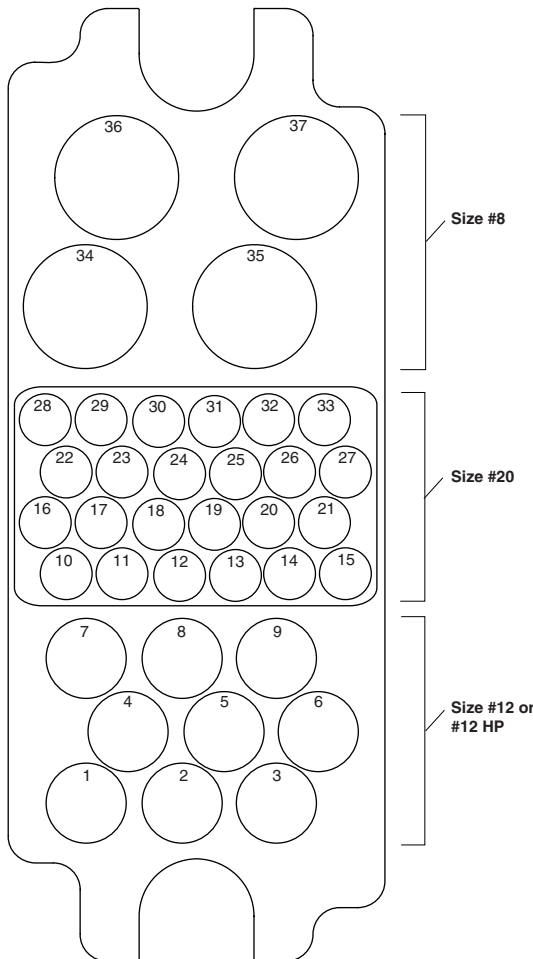

Socket Housing Selection Menu		Check One
Part Number	Description	
6648167-1	Float Mount for Crimp Contacts	<input type="checkbox"/>
1648168-1	PCB Mount for PCB Tail and Press-fit Contacts	<input type="checkbox"/>

Socket Contact Selection Menu				
Size	Ref.	Part Number	Termination Style	Qty.
<b>#8</b>	A =	6648317-1	Crimp	<input type="checkbox"/>
	B =	6648351-1	Knurled Press-fit	<input type="checkbox"/>
	C =	6648400-1	PCB Tail	<input type="checkbox"/>
<b>#20</b>	D =	1648325-1	Crimp	<input type="checkbox"/>
	E =	6648294-1	Compliant Press-fit (Flush)	<input type="checkbox"/>
	F =	1648382-1	PCB Tail	<input type="checkbox"/>
<b>#12</b>	G =	6648318-1	Crimp	<input type="checkbox"/>
	H =	6648304-1	Compliant Press-fit	<input type="checkbox"/>
	J =	6648374-1	PCB Tail	<input type="checkbox"/>
<b>#12 Hot Plug</b>	K =	1648384-1	Crimp, Hot Plug	<input type="checkbox"/>
	L =	6648305-1	Compliant Press-fit, Hot Plug	<input type="checkbox"/>
	M =	1648387-1	PCB Tail, Hot Plug	<input type="checkbox"/>

Crimp contacts are removable. Press-fit and PCB tail contacts are non-removable.

Float Mount Shoulder Screw		
Part Number	Description	Qty.
1650402-1	Screw, No 8-32 UNC 2A	<input type="checkbox"/>
1650106-1	Screw, No 6-32 UNC 2A	<input type="checkbox"/>
1650589-1	Screw, M4 x 0.7	<input type="checkbox"/>

**Top Assembly Part Number Assigned by Tyco Electronics**

AMP, ELCON, TE LOGO and TYCO ELECTRONICS are trademarks of Tyco Electronics Corporation.

## 125A Middle Drawer Connector Pin Side Layout Form

### Pin Assembly

1. Choose one housing from the **Pin Housing Selection Menu** table.
2. Write the total quantity of each pin contact you require **for each pin assembly** in the **Qty** column of the **Pin Contact Selection Menu** table.
3. Crimp contacts are shipped uninstalled. Threaded and PCB tail contacts are installed by Tyco Electronics; enter the letter reference of the desired contact in the appropriate contact positions on the drawing: e.g., if you need a non-hot plug size #12 premate PCB tail contact to be installed in contact position #4, write "Q" in circle #4.
4. Sign, date and send the completed form to your local Tyco Electronics Sales Engineer.

ENTER CUSTOMER INFORMATION	
Company	Location
Contact Name	Title
Telephone	Fax
Email Address	
I am: <input type="checkbox"/> End user <input type="checkbox"/> Contract manufacturer (end user: _____)	
Signature	Today's Date
	Annual Quantity Required

Submit to your local Tyco Electronics Sales Engineer.

**Pin Connector (Rear Face)**  
Pin Contact Insertion Side  
Pin Connector Rear Face Cavity Identification

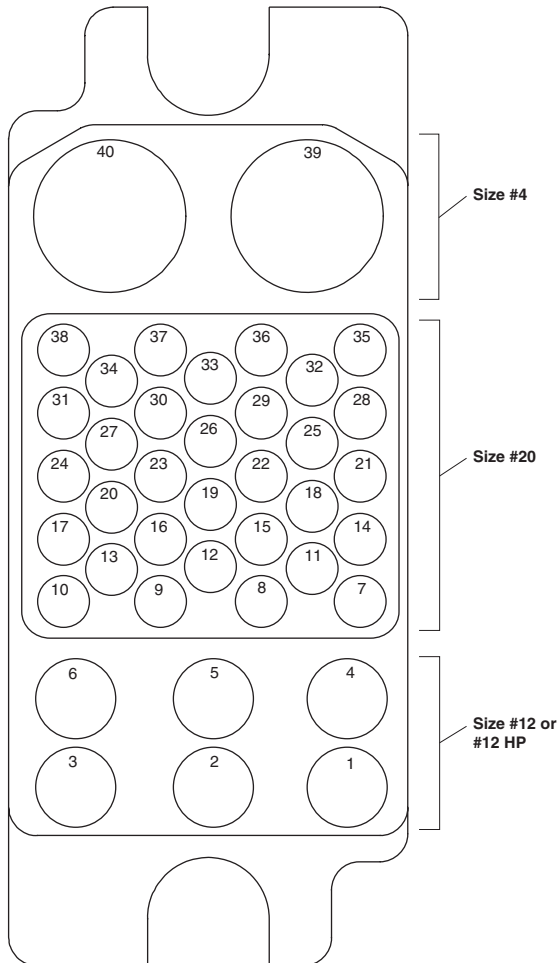

Pin Housing Selection Menu		Check One
Part Number	Description	
1648151-1	Float Mount Pin Housing	
1648152-1	PCB Mount Pin Housing	

Pin Contact Selection Menu				
Size	Ref.	Part Number	Termination Style & Pin Length	Qty.
#4	A =	1766232-1	Crimp, standard	
	B =	1766812-1	1/4-20 External Thread	
	C =	1766283-1	M5 Internal Thread	
#20	E =	1650155-1	Crimp, standard	
	F =	1650161-1	Crimp, premate	
	G =	1650162-2	Crimp, postmate	
	H =	1650283-1	PCB tail, standard	
	J =	1650065-1	PCB tail, premate	
	K =	1650226-1	PCB tail, postmate	
#12	L =	1766193-1	Crimp, standard	
	M =	1766195-1	Crimp, premate	
	N =	1766196-1	Crimp, postmate	
	P =	1766245-1	PCB tail, standard	
	Q =	1766250-1	PCB tail, premate	
	R =	1766249-1	PCB tail, postmate	
#12 Hot Plug	S =	1650153-2	Crimp, standard, Hot Plug	
	T =	1650156-2	Crimp, premate, Hot Plug	
	U =	1650060-2	PCB tail, standard, Hot Plug	
	V =	1650074-3	PCB tail, premate, Hot Plug	

Crimp and Threaded contacts are removable. PCB tail contacts are non-removable.

Float Mount Shoulder Screw		
Part Number	Description	Qty.
1650402-1	Screw, No 8-32 UNC 2A	
1650106-1	Screw, No 6-32 UNC 2A	
1650589-1	Screw, M4 x 0.7	

**Top Assembly Part Number Assigned by Tyco Electronics**

AMP, ELCON, TE LOGO and TYCO ELECTRONICS are trademarks of Tyco Electronics Corporation.



**125A Middle Drawer Connector Socket Side Layout Form**

**Socket Assembly**

1. Choose one housing from the **Socket Housing Selection Menu** table.
2. Write the total quantity of each socket contact you require for each **socket assembly** in the **Qty** column of the **Socket Contact Selection Menu** table.
3. Crimp contacts are shipped uninstalled. Threaded and PCB tail contacts are installed by Tyco Electronics; enter the letter reference of the desired contact in the appropriate contact positions on the drawing: e.g., if you need a non-hot plug size #12 PCB tail contact to be installed in contact position #4, write "J" in circle #4.
4. Sign, date and send the completed form to your local Tyco Electronics Sales Engineer.

ENTER CUSTOMER INFORMATION	
Company	Location
Contact Name	Title
Telephone	Fax
Email Address	
I am: <input type="checkbox"/> End user <input type="checkbox"/> Contract manufacturer (end user: _____)	
Signature	Today's Date
	Annual Quantity Required

Submit to your local Tyco Electronics Sales Engineer.

**Socket Connector (Rear Face)**  
Socket Contact Insertion Side  
Socket Connector Rear Face Cavity Identification

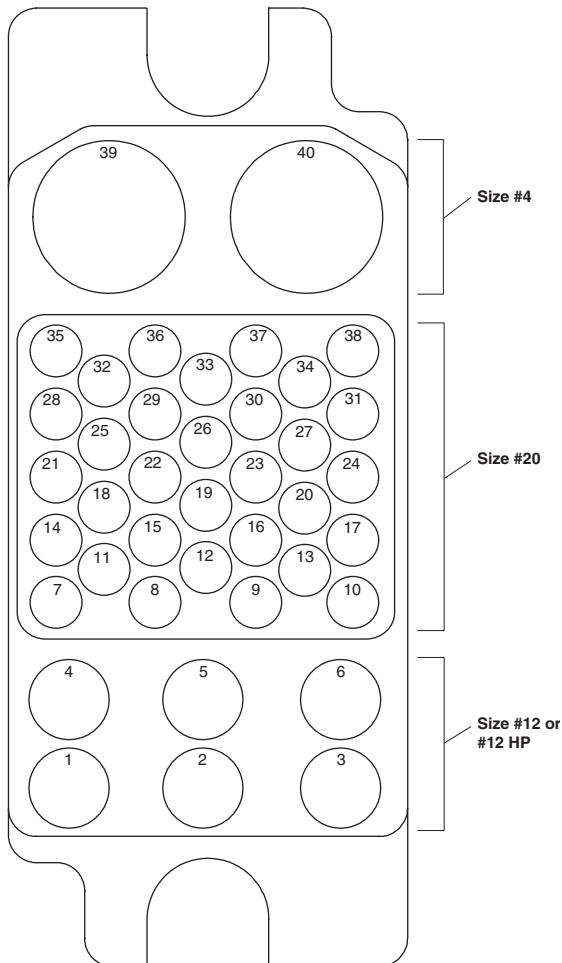

Socket Housing Selection Menu		Check One
Part Number	Description	
1648156-1	Float Mount for Crimp Contacts	
1648157-1	PCB Mount for PCB Tail and Press-fit Contacts	

Socket Contact Selection Menu				
Size	Ref.	Part Number	Termination Style	Qty.
#4	A =	6648434-1	Crimp	
	B =	6648435-1	1/4-20 External Thread	
	C =	6648335-1	M5 Internal Thread	
#20	D =	1648325-1	Crimp	
	E =	6648301-1	Compliant Press-fit	
#12	F =	1648382-1	PCB Tail	
	G =	6648318-1	Crimp	
	H =	6648304-1	Compliant Press-fit	
#12 Hot Plug	J =	6648374-1	PCB Tail	
	K =	1648384-1	Crimp, Hot Plug	
	L =	6648305-1	Compliant Press-fit, Hot Plug	
	M =	1648387-1	PCB Tail, Hot Plug	

Crimp and Threaded contacts are removable. Press-fit and PCB tail contacts are non-removable.

Float Mount Shoulder Screw		
Part Number	Description	Qty.
1650402-1	Screw, No 8-32 UNC 2A	
1650106-1	Screw, No 6-32 UNC 2A	
1650589-1	Screw, M4 x 0.7	

**Top Assembly Part Number Assigned by Tyco Electronics**

AMP, ELCON, TE LOGO and TYCO ELECTRONICS are trademarks of Tyco Electronics Corporation.

## 200A Middle Drawer Connector Pin Side Layout Form

### Pin Assembly

1. Enter company and contact information (at right).
2. Write the total quantity of each pin contact you require **for each pin assembly** in the **Qty** column of the **Pin Contact Selection Menu** table.
3. Crimp contacts are shipped uninstalled. Threaded and PCB tail contacts are installed by Tyco Electronics; enter the letter reference of the desired contact in the appropriate contact positions on the drawing: e.g., if you need a size #4 external thread contact to be installed in contact position #25, write "B" in circle #25.
4. Sign, date and send the completed form to your local Tyco Electronics Sales Engineer.

ENTER CUSTOMER INFORMATION	
Company	Location
Contact Name	Title
Telephone	Fax
Email Address	
I am: <input type="checkbox"/> End user <input type="checkbox"/> Contract manufacturer (end user: _____)	
Signature	Today's Date
	Annual Quantity Required

Submit to your local Tyco Electronics Sales Engineer.

**Pin Connector (Rear Face)**  
Pin Contact Insertion Side  
Pin Connector Rear Face Cavity Identification

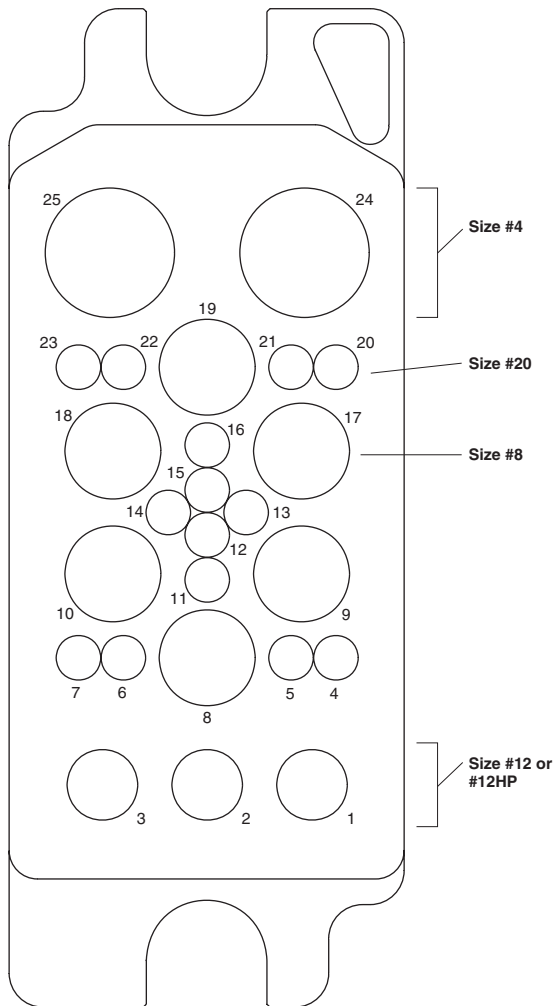

Pin Housing Part Number
1648134-1

Pin Contact Selection Menu				
Size	Ref.	Part Number	Termination Style & Pin Length	Qty.
#4	A =	1766232-1	Crimp, standard	
	B =	1766812-1	1/4-20 External Thread	
#8	C =	1766192-1	Crimp, standard	
	D =	1766197-1	Crimp, premate	
#20	E =	1650155-1	Crimp, standard	
	F =	1650161-1	Crimp, premate	
	G =	1650162-2	Crimp, postmate	
	H =	1650283-1	PCB tail, standard	
	J =	1650065-1	PCB tail, premate	
	K =	1650226-1	PCB tail, postmate	
#12	L =	1766193-1	Crimp, standard	
	M =	1766195-1	Crimp, premate	
	N =	1766196-1	Crimp, postmate	
	P =	1766245-1	PCB tail, standard	
	Q =	1766250-1	PCB tail, premate	
	R =	1766249-1	PCB tail, postmate	
#12 Hot Plug	S =	1650153-2	Crimp, standard, Hot Plug	
	T =	1650156-2	Crimp, premate, Hot Plug	
	U =	1650060-2	PCB tail, standard, Hot Plug	
	V =	1650074-3	PCB tail, premate, Hot Plug	

Crimp and Threaded contacts are removable. PCB tail contacts are non-removable.

Float Mount Shoulder Screw		
Part Number	Description	Qty.
1650402-1	Screw, No 8-32 UNC 2A	
1650589-1	Screw, M4 x 0.7	

**Top Assembly Part Number Assigned by Tyco Electronics**

AMP, ELCON, TE LOGO and TYCO ELECTRONICS are trademarks of Tyco Electronics Corporation.

## 200A Middle Drawer Connector Socket Side Layout Form

### Socket Assembly

1. Enter company and contact information (at right).
2. Write the total quantity of each socket contact you require for each socket assembly in the Qty column of the Socket Contact Selection Menu table.
3. Crimp contacts are shipped uninstalled. Threaded and PCB tail contacts are installed by Tyco Electronics; enter the letter reference of the desired contact in the appropriate contact positions on the drawing: e.g., if you need a size #4 external thread contact to be installed in contact position #25, write "B" in circle #25.
4. Sign, date and send the completed form to your local Tyco Electronics Sales Engineer.

ENTER CUSTOMER INFORMATION	
Company	Location
Contact Name	Title
Telephone	Fax
Email Address	
I am: <input type="checkbox"/> End user <input type="checkbox"/> Contract manufacturer (end user: _____)	
Signature	Today's Date
	Annual Quantity Required

Submit to your local Tyco Electronics Sales Engineer.

**Socket Connector (Rear Face)**  
Socket Contact Insertion Side  
Socket Connector Rear Face Cavity Identification

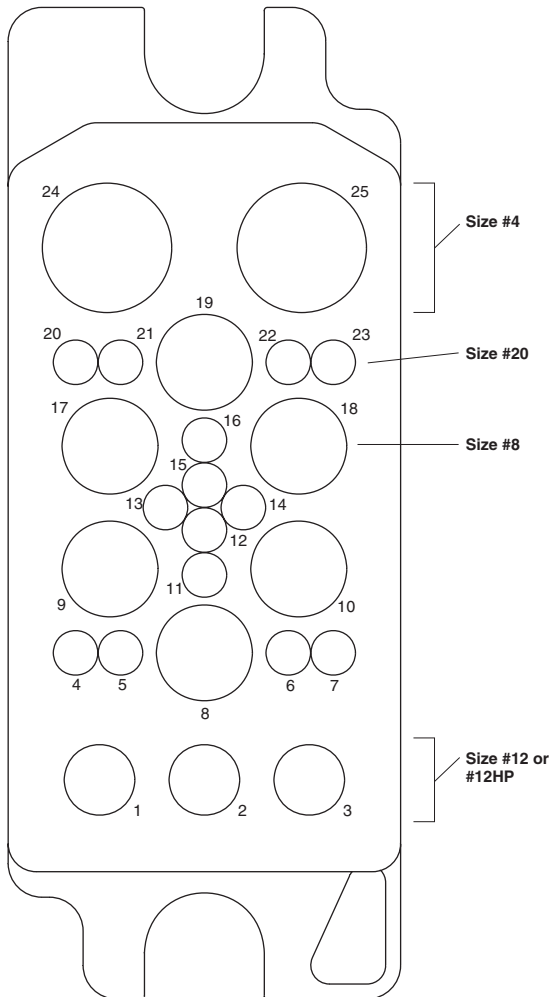

Socket Housing Part Number
1648135-1

Socket Contact Selection Menu				
Size	Ref.	Part Number	Termination Style & Pin Length	Qty.
<b>#4</b>	A =	6648434-1	Crimp	
	B =	6648435-1	1/4-20 External Thread	
<b>#8</b>	C =	6648317-1	Crimp	
	D =	6648400-1	PCB Tail	
<b>#20</b>	E =	1648325-1	Crimp	
	F =	1648382-1	PCB Tail	
<b>#12</b>	G =	6648318-1	Crimp	
	H =	6648374-1	PCB Tail	
<b>#12 Hot Plug</b>	J =	1648384-1	Crimp, Hot Plug	
	K =	1648387-1	PCB Tail, Hot Plug	

Crimp and Threaded contacts are removable. Press-fit and PCB tail contacts are non-removable.

Float Mount Shoulder Screw		
Part Number	Description	Qty.
1650402-1	Screw, No 8-32 UNC 2A	
1650589-1	Screw, M4 x 0.7	

**Top Assembly Part Number  
Assigned by Tyco Electronics**

AMP, ELCON, TE LOGO and TYCO ELECTRONICS are trademarks of Tyco Electronics Corporation.

**Square Drawer Connector Pin Side Layout Form**

**Pin Assembly**

1. Enter company and contact information (at right).
2. Write the total quantity of each pin contact you require **for each pin assembly** in the **Qty** column of the **Pin Contact Selection Menu** table.
3. Crimp contacts are shipped uninstalled. PCB tail contacts are installed by Tyco Electronics; enter the letter reference of the desired PCB tail contact in the appropriate contact positions on the drawing: e.g., if you need a non-hot plug size #12 standard PCB tail contact to be installed in contact position #1, write "K" in circle #1.
4. Sign, date and send the completed form to your local Tyco Electronics Sales Engineer.

ENTER CUSTOMER INFORMATION	
Company	Location
Contact Name	Title
Telephone	Fax
Email Address	
I am: <input type="checkbox"/> End user <input type="checkbox"/> Contract manufacturer (end user: _____)	
Signature	Today's Date
	Annual Quantity Required

Submit to your local Tyco Electronics Sales Engineer.

**Pin Connector (Rear Face)**  
Pin Contact Insertion Side  
Pin Connector Rear Face Cavity Identification

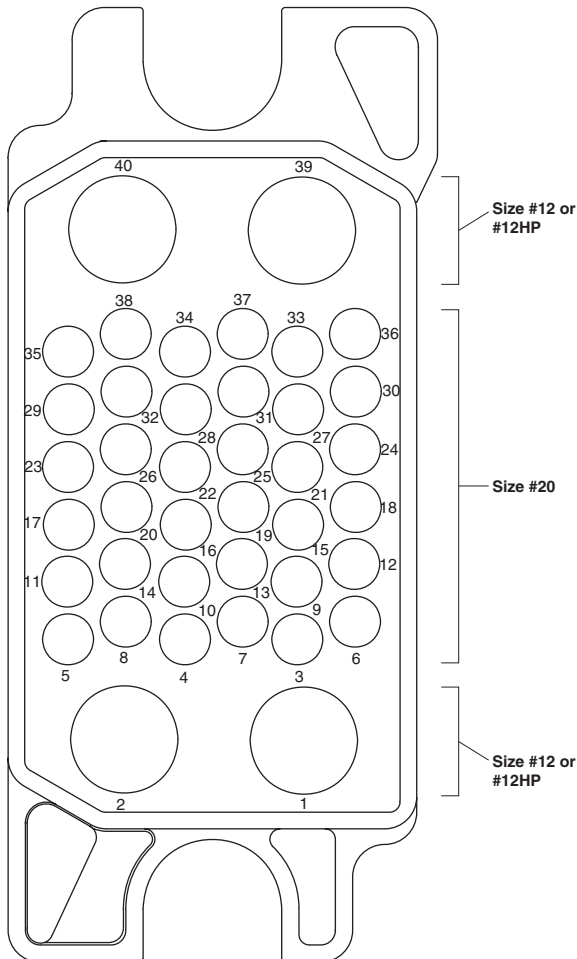

Pin Housing Part Number
1648132-1

Pin Contact Selection Menu				
Size	Ref.	Part Number	Termination Style & Pin Length	Qty.
#20	A =	1650155-1	Crimp, standard	
	B =	1650161-1	Crimp, premate	
	C =	1650162-2	Crimp, postmate	
	D =	1650283-1	PCB tail, standard	
	E =	1650065-1	PCB tail, premate	
	F =	1650226-1	PCB tail, postmate	
#12	G =	1766193-1	Crimp, standard	
	H =	1766195-1	Crimp, premate	
	J =	1766196-1	Crimp, postmate	
	K =	1766245-1	PCB tail, standard	
	L =	1766250-1	PCB tail, premate	
	M =	1766249-1	PCB tail, postmate	
#12 Hot Plug	N =	1650153-2	Crimp, standard, Hot Plug	
	P =	1650156-2	Crimp, premate, Hot Plug	
	Q =	1650060-2	PCB tail, standard, Hot Plug	
	R =	1650074-3	PCB tail, premate, Hot Plug	

Crimp contacts are removable. PCB tail contacts are non-removable.

Float Mount Shoulder Screw		
Part Number	Description	Qty.
1650402-1	Screw, No 8-32 UNC 2A	
1650589-1	Screw, M4 x 0.7	

**Top Assembly Part Number Assigned by Tyco Electronics**

AMP, ELCON, TE LOGO and TYCO ELECTRONICS are trademarks of Tyco Electronics Corporation.



**Square Drawer Connector Socket Side Layout Form**

**Socket Assembly**

1. Enter company and contact information (at right).
2. Write the total quantity of each socket contact you require for each socket assembly in the Qty column of the Socket Contact Selection Menu table.
3. Crimp contacts are shipped uninstalled. Press-fit and PCB tail contacts are installed by Tyco Electronics; enter the letter reference of the desired contact in the appropriate contact positions on the drawing: e.g., if you need a non-hot plug size #12 PCB tail contact to be installed in contact position #1, write "F" in circle #1.
4. Sign, date and send the completed form to your local Tyco Electronics Sales Engineer.

ENTER CUSTOMER INFORMATION	
Company	Location
Contact Name	Title
Telephone	Fax
Email Address	
I am: <input type="checkbox"/> End user <input type="checkbox"/> Contract manufacturer (end user: _____)	
Signature	Today's Date
	Annual Quantity Required

Submit to your local Tyco Electronics Sales Engineer.

**Socket Connector (Rear Face)**  
Socket Contact Insertion Side  
Socket Connector Rear Face Cavity Identification

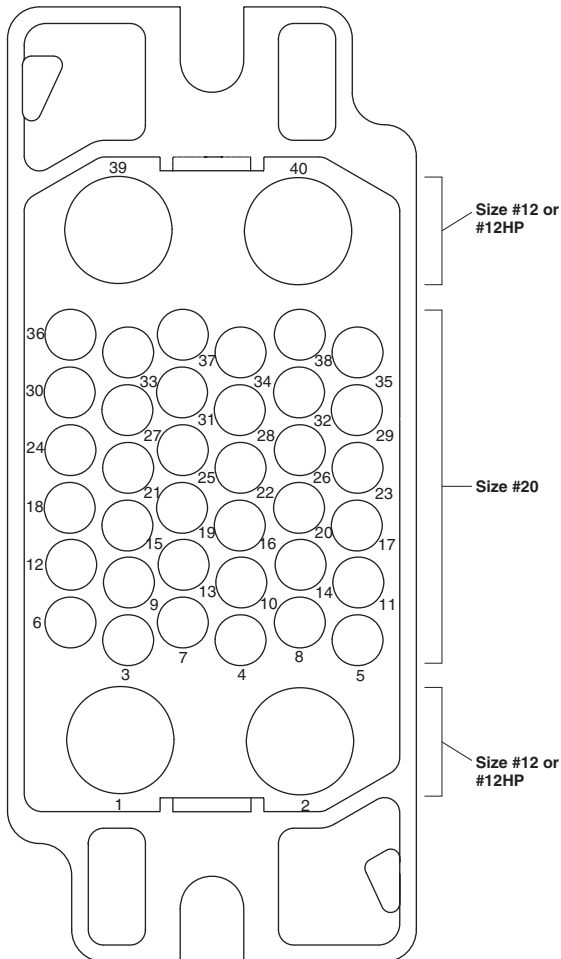

Socket Housing Part Number
1648133-1 = Fixed Mount only

Socket Contact Selection Menu				
Size	Ref.	Part Number	Termination Style & Pin Length	Qty.
#20	A =	1648325-1	Crimp	
	B =	6648301-1	Compliant Press-fit	
	C =	1648382-1	PCB Tail	
#12	D =	6648318-1	Crimp	
	E =	6648304-1	Compliant Press-fit	
#12 Hot Plug	F =	6648374-1	PCB Tail	
	G =	1648384-1	Crimp, Hot Plug	
	H =	6648305-1	Compliant Press-fit, Hot Plug	
	J =	1648387-1	PCB Tail, Hot Plug	

Crimp contacts are removable. Press-fit and PCB tail contacts are non-removable.

**Top Assembly Part Number Assigned by Tyco Electronics**

AMP, ELCON, TE LOGO and TYCO ELECTRONICS are trademarks of Tyco Electronics Corporation.

## Top Drawer Connector Pin Side Layout Form

### Pin Assembly

1. Choose one housing from the **Pin Housing Selection Menu** table. Place an X in the appropriate guide pin circles, if guide pins are required.
2. Write the total quantity of each pin contact you require for each pin assembly in the **Qty** column of the **Pin Contact Selection Menu** table.
3. Crimp contacts are shipped uninstalled. Threaded and PCB tail contacts are installed by Tyco Electronics; enter the letter reference of the desired contact in the appropriate contact positions on the drawing: e.g., if you need a size #20 premate PCB tail standard contact to be installed in contact position #10, write "Q" in circle #10.
4. Sign, date and send the completed form to your local Tyco Electronics Sales Engineer.

**Pin Connector (Rear Face)**  
Pin Contact Insertion Side  
Pin Connector Rear Face Cavity Identification

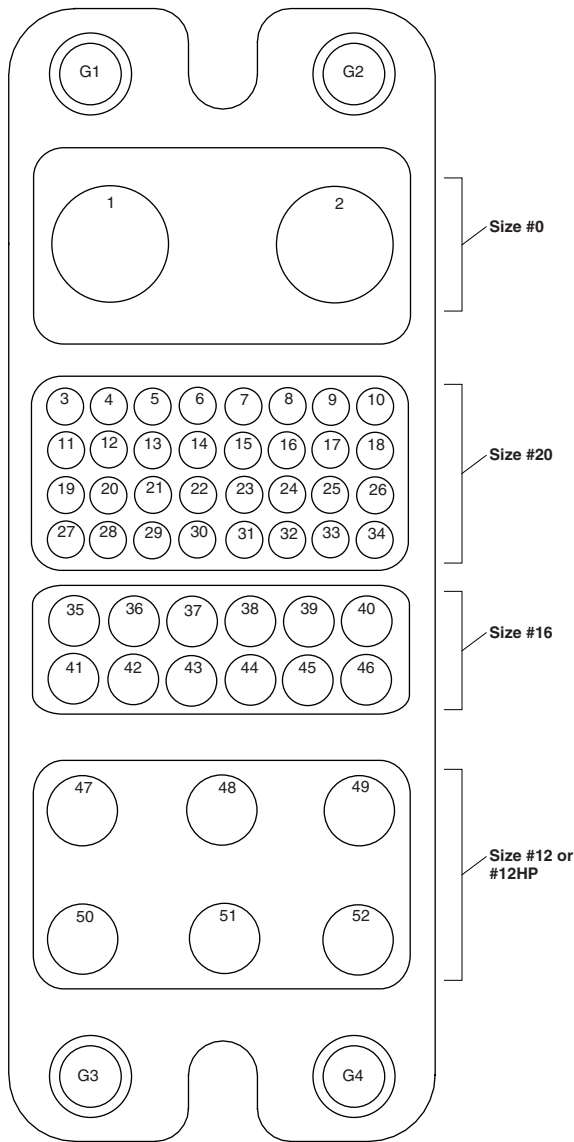

**Top Assembly Part Number Assigned by Tyco Electronics**

AMP, ELCON, TE LOGO and TYCO ELECTRONICS are trademarks of Tyco Electronics Corporation.

ENTER CUSTOMER INFORMATION	
Company	Location
Contact Name	Title
Telephone	Fax
Email Address	
I am: <input type="checkbox"/> End user <input type="checkbox"/> Contract manufacturer (end user: _____)	
Signature	Today's Date
	Annual Quantity Required

Submit to your local Tyco Electronics Sales Engineer.

Pin Housing Selection Menu		Check One
<b>Part Number</b>	<b>Description</b>	
1648183-1	Housing without guides	
	Housing with guides (#6-32 thread)	
	Housing with guides (M3 x 0.5 thread)	

Pin Contact Selection Menu				Qty.
Size	Ref.	Part Number	Termination Style & Pin Length	
#0	A =	1766811-1	Crimp	
	B =	1766819-1	Probe Proof, crimp	
	C =	1766230-1	1/4-20 Internal Thread	
	D =	1766274-1	M6 x 1 Internal Thread	
	E =	1766269-1	Probe Proof, 1/4-20 Internal Thread	
	F =	1766275-1	Probe Proof, M6 x 1 Internal Thread	
	G =	1766268-1	1/4-20 External Thread	
	H =	1766231-1	M6 x 1 External Thread	
	J =	1766270-1	Probe Proof, 1/4-20 External Thread	
	K =	1766276-1	Probe Proof, M6 x 1 External Thread	
	#20	L =	1650155-1	Crimp, standard
M =		1650161-1	Crimp, premate	
N =		1650162-2	Crimp, postmate	
P =		1650283-1	PCB tail, standard	
Q =		1650065-1	PCB tail, premate	
R =		1650226-1	PCB tail, postmate	
#16	S =	1766194-1	Crimp, standard	
	T =	1766198-1	Crimp, premate	
	U =	1766199-1	Crimp, postmate	
	V =	1766222-1	PCB tail, standard	
	W =	1766223-1	PCB tail, premate	
	X =	1766818-1	PCB tail, postmate	
#12	Y =	1766193-1	Crimp, standard	
	Z =	1766195-1	Crimp, premate	
	AA =	1766196-1	Crimp, postmate	
	AB =	1766245-1	PCB tail, standard	
	AC =	1766250-1	PCB tail, premate	
	AD =	1766249-1	PCB tail, postmate	
#12 Hot Plug	AE =	1650153-2	Crimp, standard, Hot Plug	
	AF =	1650156-2	Crimp, premate, Hot Plug	
	AG =	1650060-2	PCB tail, standard, Hot Plug	
	AH =	1650074-3	PCB tail, premate, Hot Plug	

Crimp and Threaded contacts are removable. PCB tail contacts are non-removable.

Float Mount Shoulder Screw		
Part Number	Description	Qty.
1650399-1	Screw, No 10-32 UNC 2A	
1650401-1	Screw, M5 x 0.8	

**Top Drawer Connector Socket Side Layout Form**

**Socket Assembly**

1. Choose one housing from the **Socket Housing Selection Menu** table. Place an X in the appropriate guide pin circles, if guide pins are required.
2. Write the total quantity of each socket contact you require for each socket assembly in the **Qty** column of the **Socket Contact Selection Menu** table.
3. Crimp contacts are shipped uninstalled. Threaded, Press-fit and PCB tail contacts are installed by Tyco Electronics; enter the letter reference of the desired contact in the appropriate contact positions on the drawing: e.g., if you need a non-hot plug size #12 PCB tail contact to be installed in contact position #51, write "U" in circle #51.
4. Sign, date and send the completed form to your local Tyco Electronics Sales Engineer.

**Socket Connector (Rear Face)**  
 Socket Contact Insertion Side  
 Socket Connector Rear Face Cavity Identification

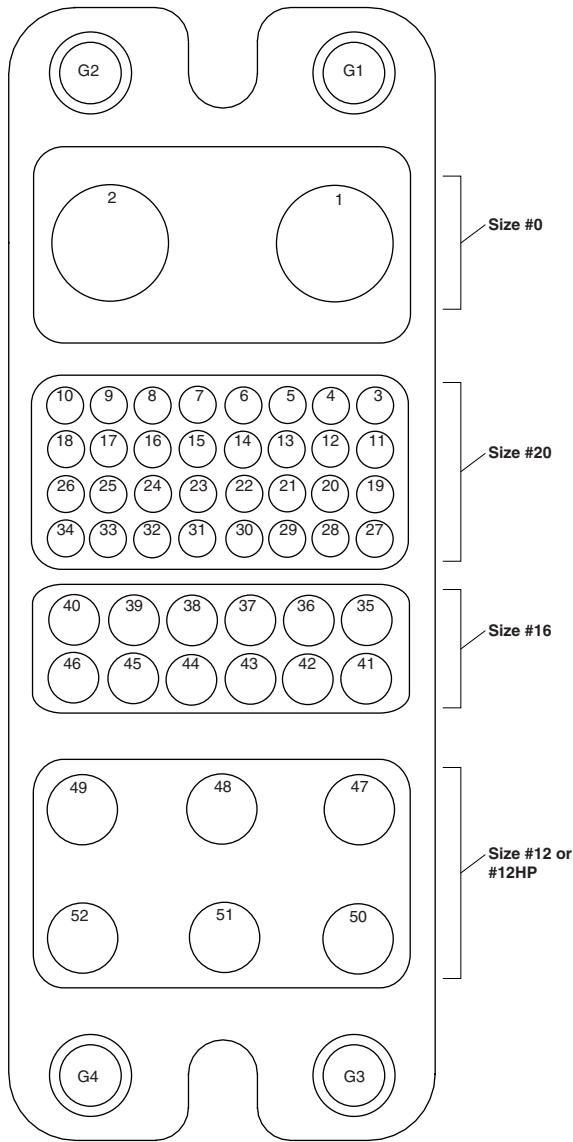

**Top Assembly Part Number Assigned by Tyco Electronics**

ENTER CUSTOMER INFORMATION	
Company	Location
Contact Name	Title
Telephone	Fax
Email Address	
I am: <input type="checkbox"/> End user <input type="checkbox"/> Contract manufacturer (end user: _____)	
Signature	Today's Date
	Annual Quantity Required

Submit to your local Tyco Electronics Sales Engineer.

Pin Housing Selection Menu		Check One
Part Number	Description	
1648186-1	Housing without guides	
	Housing with guides (#6-32 thread)	
	Housing with guides (M3 x 0.5 thread)	

Socket Contact Selection Menu				
Size	Ref.	Part Number	Termination Style & Pin Length	Qty.
#0	A =	6648405-1	Crimp	
	B =	6648418-1	Probe Proof, crimp	
	C =	6648416-1	1/4-20 Internal Thread	
	D =	6648428-1	M6 x 1 Internal Thread	
	E =	6648419-1	Probe Proof, 1/4-20 Internal Thread	
	F =	6648429-1	Probe Proof, M6 x 1 Internal Thread	
	G =	6648417-1	1/4-20 External Thread	
	H =	6648430-1	M6 x 1 External Thread	
	J =	6648420-1	Probe Proof, 1/4-20 External Thread	
	K =	6648431-1	Probe Proof, M6 x 1 External Thread	
#20	L =	1648325-1	Crimp	
	M =	6648301-1	Compliant Press-fit	
	N =	1648382-1	PCB Tail	
#16	P =	6648319-1	Crimp	
	Q =	6648306-1	Compliant Press-fit	
	R =	6648383-1	PCB Tail	
#12	S =	6648318-1	Crimp	
	T =	6648304-1	Compliant Press-fit	
	U =	6648374-1	PCB Tail	
#12 Hot Plug	V =	1648384-1	Crimp, Hot Plug	
	W =	6648305-1	Compliant Press-fit, Hot Plug	
	X =	1648387-1	PCB Tail, Hot Plug	

Crimp and Threaded contacts are removable. Press-fit and PCB tail contacts are non-removable.

Float Mount Shoulder Screw		
Part Number	Description	Qty.
1650399-1	Screw, No 10-32 UNC 2A	
1650401-1	Screw, M5 x 0.8	

AMP, ELCON, TE LOGO and TYCO ELECTRONICS are trademarks of Tyco Electronics Corporation.

## Double Drawer Connector Pin Side Layout Form

### Pin Assembly

1. Choose one housing from the **Pin Housing Selection Menu** table. Place an X in the appropriate guide pin circles, if guide pins are required.
2. Write the total quantity of each pin contact you require **for each pin assembly** in the **Qty** column of the **Pin Contact Selection Menu** table.
3. Crimp contacts are shipped uninstalled. Threaded and PCB tail contacts are installed by Tyco Electronics; enter the letter reference of the desired contact in the appropriate contact positions on the drawing: e.g., if you need a size #20 premate PCB tail contact to be installed in contact position #13, write "Q" in circle #13.
4. Sign, date and send the completed form to your local Tyco Electronics Sales Engineer.

ENTER CUSTOMER INFORMATION	
Company	Location
Contact Name	Title
Telephone	Fax
Email Address	
I am: <input type="checkbox"/> End user <input type="checkbox"/> Contract manufacturer (end user: _____)	
Signature	Today's Date
	Annual Quantity Required

Submit to your local Tyco Electronics Sales Engineer.

**Pin Connector (Rear Face)**  
Pin Contact Insertion Side  
Pin Connector Rear Face Cavity Identification

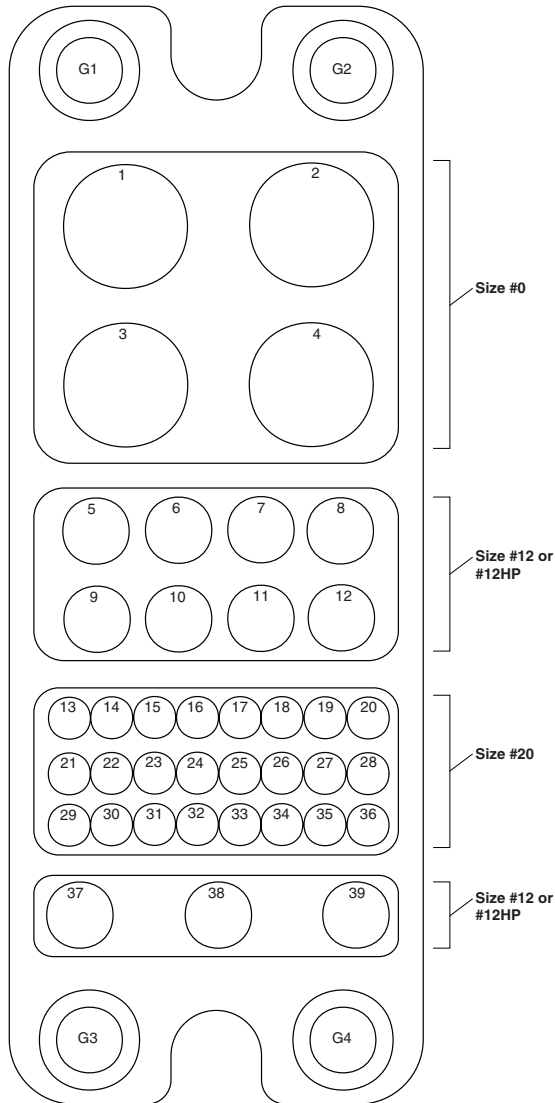

**Top Assembly Part Number  
Assigned by Tyco Electronics**

Pin Housing Selection Menu		Check One
Part Number	Description	
164852-1	Housing without guides	
	Housing with guides (#6-32 thread)	
	Housing with guides (M3 x 0.5 thread)	

Pin Contact Selection Menu				
Size	Ref.	Part Number	Termination Style & Pin Length	Qty.
#0	A =	1766811-1	Crimp	
	B =	1766819-1	Probe Proof, crimp	
	C =	1766230-1	1/4-20 Internal Thread	
	D =	1766274-1	M6 x 1 Internal Thread	
	E =	1766269-1	Probe Proof, 1/4-20 Internal Thread	
	F =	1766275-1	Probe Proof, M6 x 1 Internal Thread	
	G =	1766268-1	1/4-20 External Thread	
	H =	1766231-1	M6 x 1 External Thread	
	J =	1766270-1	Probe Proof, 1/4-20 External Thread	
	K =	1766276-1	Probe Proof, M6 x 1 External Thread	
#20	L =	1650155-1	Crimp, standard	
	M =	1650161-1	Crimp, premate	
	N =	1650162-2	Crimp, postmate	
	P =	1650283-1	PCB tail, standard	
	Q =	1650065-1	PCB tail, premate	
	R =	1650226-1	PCB tail, postmate	
#12	S =	1766193-1	Crimp, standard	
	T =	1766195-1	Crimp, premate	
	U =	1766196-1	Crimp, postmate	
	V =	1766245-1	PCB tail, standard	
	W =	1766250-1	PCB tail, premate	
	X =	1766249-1	PCB tail, postmate	
#12 Hot Plug	Y =	1650153-2	Crimp, standard, Hot Plug	
	Z =	1650156-2	Crimp, premate, Hot Plug	
	AA =	1650060-2	PCB tail, standard, Hot Plug	
	AB =	1650074-3	PCB tail, premate, Hot Plug	

Crimp and Threaded contacts are removable. PCB tail contacts are non-removable.

Float Mount Shoulder Screw		
Part Number	Description	Qty.
1650399-1	Screw, No 10-32 UNC 2A	
1650401-1	Screw, M5 x 0.8	

AMP, ELCON, TE LOGO and TYCO ELECTRONICS are trademarks of Tyco Electronics Corporation.



## Double Drawer Connector Socket Side Layout Form

### Socket Assembly

1. Choose one housing from the **Socket Housing Selection Menu** table. Place an X in the appropriate guide pin circles, if guide pins are required.
2. Write the total quantity of each socket contact you require for each socket assembly in the **Qty** column of the **Socket Contact Selection Menu** table.
3. Crimp contacts are shipped uninstalled. Threaded, Press-fit and PCB tail contacts are installed by Tyco Electronics; enter the letter reference of the desired contact in the appropriate contact positions on the drawing: e.g., if you need a non-hot plug size #12 PCB tail contact to be installed in contact position #8, write "R" in circle #8.
4. Sign, date and send the completed form to your local Tyco Electronics Sales Engineer.

ENTER CUSTOMER INFORMATION	
Company	Location
Contact Name	Title
Telephone	Fax
Email Address	
I am: <input type="checkbox"/> End user <input type="checkbox"/> Contract manufacturer (end user: _____)	
Signature	Today's Date
	Annual Quantity Required

Submit to your local Tyco Electronics Sales Engineer.

**Socket Connector (Rear Face)**  
Socket Contact Insertion Side  
Socket Connector Rear Face Cavity Identification

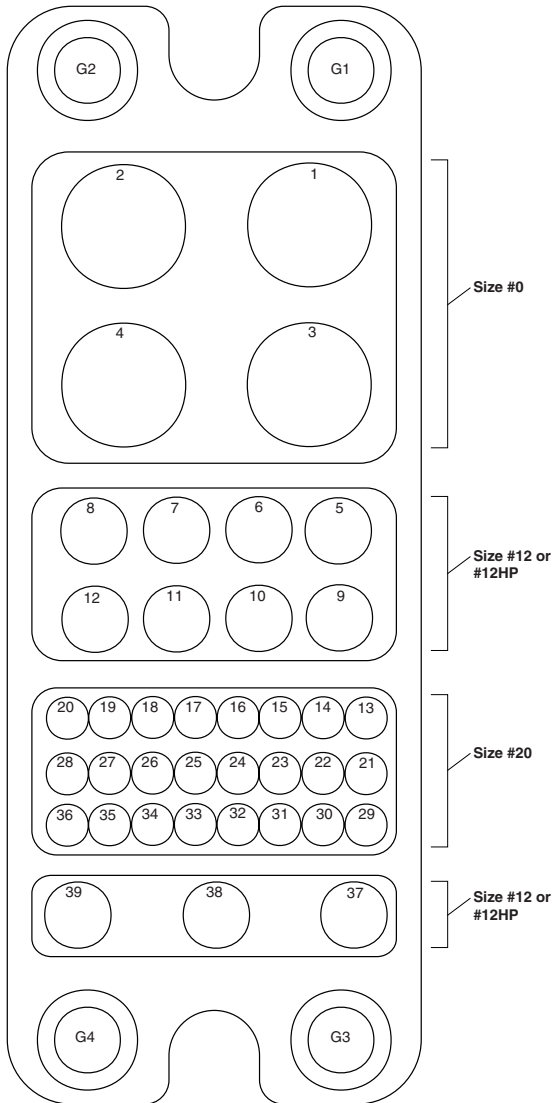

**Top Assembly Part Number  
Assigned by Tyco Electronics**

Socket Housing Selection Menu		Check One
Part Number	Description	
1648578-1	Housing without guides	
	Housing with guides (#6-32 thread)	
	Housing with guides (M3 x 0.5 thread)	

Socket Contact Selection Menu				
Size	Ref.	Part Number	Termination Style & Pin Length	Qty.
#0	A =	6648405-1	Crimp	
	B =	6648418-1	Probe Proof, crimp	
	C =	6648416-1	1/4-20 Internal Thread	
	D =	6648428-1	M6 x 1 Internal Thread	
	E =	6648419-1	Probe Proof, 1/4-20 Internal Thread	
	F =	6648429-1	Probe Proof, M6 x 1 Internal Thread	
	G =	6648417-1	1/4-20 External Thread	
	H =	6648430-1	M6 x 1 External Thread	
	J =	6648420-1	Probe Proof, 1/4-20 External Thread	
	K =	6648431-1	Probe Proof, M6 x 1 External Thread	
	#20	L =	1648325-1	Crimp
M =		6648301-1	Compliant Press-fit	
N =		1648382-1	PCB Tail	
#12	P =	6648318-1	Crimp	
	Q =	6648304-1	Compliant Press-fit	
	R =	6648374-1	PCB Tail	
#12 Hot Plug	S =	1648384-1	Crimp, Hot Plug	
	T =	6648305-1	Compliant Press-fit, Hot Plug	
	U =	1648387-1	PCB Tail, Hot Plug	

Crimp and Threaded contacts are removable. Press-fit and PCB tail contacts are non-removable.

Float Mount Shoulder Screw		
Part Number	Description	Qty.
1650399-1	Screw, No 10-32 UNC 2A	
1650401-1	Screw, M5 x 0.8	

AMP, ELCON, TE LOGO and TYCO ELECTRONICS are trademarks of Tyco Electronics Corporation.

## DualPower Drawer Connector Pin Side Layout Form

### Pin Assembly

1. Choose one housing from the **Pin Housing Selection Menu** table. Place an X in the appropriate guide pin circles, if guide pins are required.
2. Write the total quantity of each pin contact you require **for each pin assembly** in the **Qty** column of the **Pin Contact Selection Menu** table.
3. Crimp contacts are shipped uninstalled. Threaded contacts are installed by Tyco Electronics; enter the letter reference of the desired threaded contact in the appropriate contact positions on the drawing: e.g., if you need a size #0 1/4-20 external thread contact to be installed in contact position #1, write "G" in circle #1.
4. Sign, date and send the completed form to your local Tyco Electronics Sales Engineer.

ENTER CUSTOMER INFORMATION	
Company	Location
Contact Name	Title
Telephone	Fax
Email Address	
I am: <input type="checkbox"/> End user <input type="checkbox"/> Contract manufacturer (end user: _____)	
Signature	Today's Date
	Annual Quantity Required

Submit to your local Tyco Electronics Sales Engineer.

**Pin Connector (Rear Face)**  
Pin Contact Insertion Side  
Pin Connector Rear Face Cavity Identification

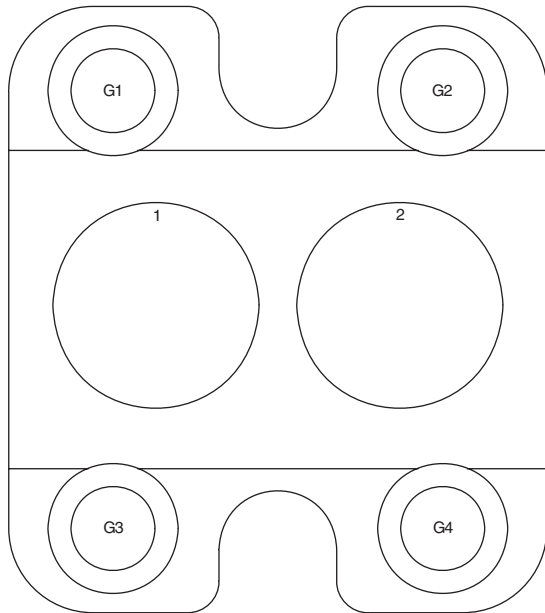

**Top Assembly Part Number  
Assigned by Tyco Electronics**

Pin Housing Selection Menu		Check One
Part Number	Description	
1648549-1	Housing without guides	
	Housing with guides (#6-32 thread)	
	Housing with guides (M3 x 0.5 thread)	

Pin Contact Selection Menu				
Size	Ref.	Part Number	Termination Style & Pin Length	Qty.
#0	A =	1766811-1	Crimp	
	B =	1766819-1	Probe Proof, crimp	
	C =	1766230-1	1/4-20 Internal Thread	
	D =	1766274-1	M6 x 1 Internal Thread	
	E =	1766269-1	Probe Proof, 1/4-20 Internal Thread	
	F =	1766275-1	Probe Proof, M6 x 1 Internal Thread	
	G =	1766268-1	1/4-20 External Thread	
	H =	1766231-1	M6 x 1 External Thread	
	J =	1766270-1	Probe Proof, 1/4-20 External Thread	
	K =	1766276-1	Probe Proof, M6 x 1 External Thread	

Contacts are removable.

Float Mount Shoulder Screw		
Part Number	Description	Qty.
1650399-1	Screw, No 10-32 UNC 2A	
1650401-1	Screw, M5 x 0.8	

AMP, ELCON, TE LOGO and TYCO ELECTRONICS are trademarks of Tyco Electronics Corporation.

## DualPower Drawer Connector Socket Side Layout Form

### Socket Assembly

1. Choose one housing from the **Socket Housing Selection Menu** table. Place an X in the appropriate guide pin circles, if guide pins are required.
2. Write the total quantity of each socket contact you require **for each socket assembly** in the **Qty** column of the **Socket Contact Selection Menu** table.
3. Crimp contacts are shipped uninstalled. Threaded contacts are installed by Tyco Electronics; enter the letter reference of the desired threaded contact in the appropriate contact positions on the drawing: e.g., if you need a size #0 1/4-20 external thread contact to be installed in contact position #1, write "G" in circle #1.
4. Sign, date and send the completed form to your local Tyco Electronics Sales Engineer.

ENTER CUSTOMER INFORMATION	
Company	Location
Contact Name	Title
Telephone	Fax
Email Address	
I am: <input type="checkbox"/> End user <input type="checkbox"/> Contract manufacturer (end user: _____)	
Signature	Today's Date
	Annual Quantity Required

Submit to your local Tyco Electronics Sales Engineer.

**Socket Connector (Rear Face)**  
Socket Contact Insertion Side  
Socket Connector Rear Face Cavity Identification

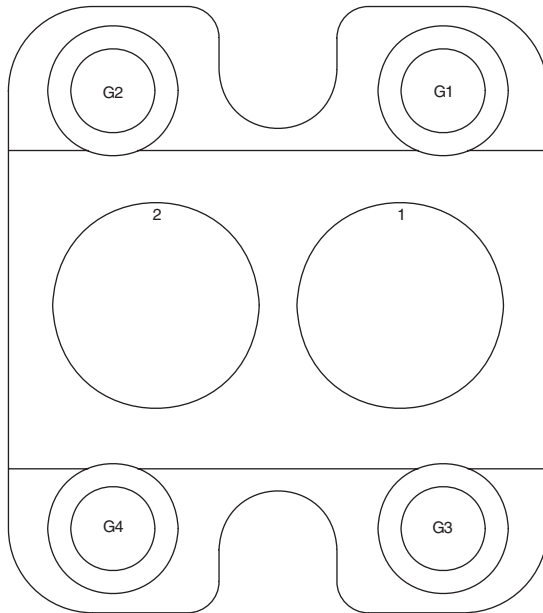

**Top Assembly Part Number  
Assigned by Tyco Electronics**

Socket Housing Selection Menu		Check One
Part Number	Description	
1648575-1	Housing without guides	
	Housing with guides (#6-32 thread)	
	Housing with guides (M3 x 0.5 thread)	

Socket Contact Selection Menu				
Size	Ref.	Part Number	Termination Style & Pin Length	Qty.
#0	A =	6648405-1	Crimp	
	B =	6648418-1	Probe Proof, crimp	
	C =	6648416-1	1/4-20 Internal Thread	
	D =	6648428-1	M6 x 1 Internal Thread	
	E =	6648419-1	Probe Proof, 1/4-20 Internal Thread	
	F =	6648429-1	Probe Proof, M6 x 1 Internal Thread	
	G =	6648417-1	1/4-20 External Thread	
	H =	6648430-1	M6 x 1 External Thread	
	J =	6648420-1	Probe Proof, 1/4-20 External Thread	
	K =	6648431-1	Probe Proof, M6 x 1 External Thread	

Contacts are removable.

Float Mount Shoulder Screw		
Part Number	Description	Qty.
1650399-1	Screw, No 10-32 UNC 2A	
1650401-1	Screw, M5 x 0.8	

## QuadPower Drawer Connector Pin Side Layout Form

### Pin Assembly

1. Choose one housing from the **Pin Housing Selection Menu** table. Place an X in the appropriate guide pin circles, if guide pins are required.
2. Write the total quantity of each pin contact you require **for each pin assembly** in the **Qty** column of the **Pin Contact Selection Menu** table.
3. Crimp contacts are shipped uninstalled. Threaded contacts are installed by Tyco Electronics; enter the letter reference of the desired threaded contact in the appropriate contact positions on the drawing: e.g., if you need a size #0 1/4-20 external thread contact to be installed in contact position #1, write "G" in circle #1.
4. Sign, date and send the completed form to your local Tyco Electronics Sales Engineer.

ENTER CUSTOMER INFORMATION	
Company	Location
Contact Name	Title
Telephone	Fax
Email Address	
I am: <input type="checkbox"/> End user <input type="checkbox"/> Contract manufacturer (end user: _____)	
Signature	Today's Date
	Annual Quantity Required

Submit to your local Tyco Electronics Sales Engineer.

**Pin Connector (Rear Face)**  
Pin Contact Insertion Side  
Pin Connector Rear Face Cavity Identification

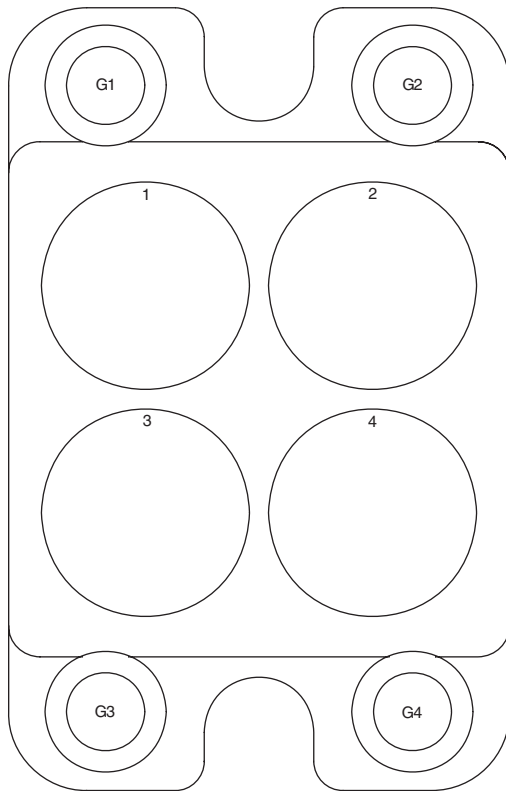

**Top Assembly Part Number  
Assigned by Tyco Electronics**

Pin Housing Selection Menu		Check One
Part Number	Description	
1648548-1	Housing without guides	<input type="checkbox"/>
	Housing with guides (#6-32 thread)	<input type="checkbox"/>
	Housing with guides (M3 x 0.5 thread)	<input type="checkbox"/>

Pin Contact Selection Menu				
Size	Ref.	Part Number	Termination Style & Pin Length	Qty.
#0	A =	1766811-1	Crimp	<input type="checkbox"/>
	B =	1766819-1	Probe Proof, crimp	<input type="checkbox"/>
	C =	1766230-1	1/4-20 Internal Thread	<input type="checkbox"/>
	D =	1766274-1	M6 x 1 Internal Thread	<input type="checkbox"/>
	E =	1766269-1	Probe Proof, 1/4-20 Internal Thread	<input type="checkbox"/>
	F =	1766275-1	Probe Proof, M6 x 1 Internal Thread	<input type="checkbox"/>
	G =	1766268-1	1/4-20 External Thread	<input type="checkbox"/>
	H =	1766231-1	M6 x 1 External Thread	<input type="checkbox"/>
	J =	1766270-1	Probe Proof, 1/4-20 External Thread	<input type="checkbox"/>
	K =	1766276-1	Probe Proof, M6 x 1 External Thread	<input type="checkbox"/>

Contacts are removable.

Float Mount Shoulder Screw		
Part Number	Description	Qty.
1650399-1	Screw, No 10-32 UNC 2A	<input type="checkbox"/>
1650401-1	Screw, M5 x 0.8	<input type="checkbox"/>

AMP, ELCON, TE LOGO and TYCO ELECTRONICS are trademarks of Tyco Electronics Corporation.

## QuadPower Drawer Connector Socket Side Layout Form

### Socket Assembly

1. Choose one housing from the **Socket Housing Selection Menu** table. Place an X in the appropriate guide pin circles, if guide pins are required.
2. Write the total quantity of each socket contact you require **for each socket assembly** in the **Qty** column of the **Socket Contact Selection Menu** table.
3. Crimp contacts are shipped uninstalled. Threaded contacts are installed by Tyco Electronics; enter the letter reference of the desired threaded contact in the appropriate contact positions on the drawing: e.g., if you need a size #0 1/4-20 external thread contact to be installed in contact position #1, write "G" in circle #1.
4. Sign, date and send the completed form to your local Tyco Electronics Sales Engineer.

ENTER CUSTOMER INFORMATION	
Company	Location
Contact Name	Title
Telephone	Fax
Email Address	
I am: <input type="checkbox"/> End user <input type="checkbox"/> Contract manufacturer (end user: _____)	
Signature	Today's Date
	Annual Quantity Required

Submit to your local Tyco Electronics Sales Engineer.

**Socket Connector (Rear Face)**  
Socket Contact Insertion Side  
Socket Connector Rear Face Cavity Identification

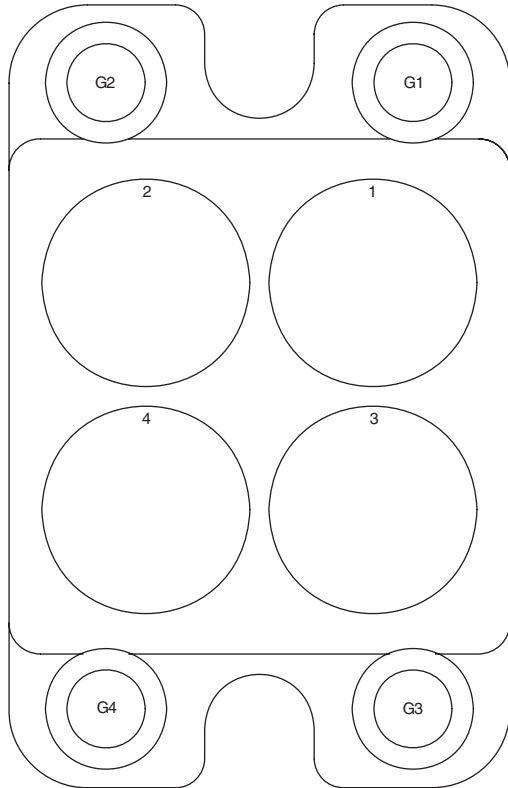

**Top Assembly Part Number  
Assigned by Tyco Electronics**

Socket Housing Selection Menu		Check One
Part Number	Description	
1648574-1	Housing without guides	
	Housing with guides (#6-32 thread)	
	Housing with guides (M3 x 0.5 thread)	

Socket Contact Selection Menu				
Size	Ref.	Part Number	Termination Style & Pin Length	Qty.
#0	A =	6648405-1	Crimp	
	B =	6648418-1	Probe Proof, crimp	
	C =	6648416-1	1/4-20 Internal Thread	
	D =	6648428-1	M6 x 1 Internal Thread	
	E =	6648419-1	Probe Proof, 1/4-20 Internal Thread	
	F =	6648429-1	Probe Proof, M6 x 1 Internal Thread	
	G =	6648417-1	1/4-20 External Thread	
	H =	6648430-1	M6 x 1 External Thread	
	J =	6648420-1	Probe Proof, 1/4-20 External Thread	
	K =	6648431-1	Probe Proof, M6 x 1 External Thread	

Contacts are removable.

Float Mount Shoulder Screw		
Part Number	Description	Qty.
1650399-1	Screw, No 10-32 UNC 2A	
1650401-1	Screw, M5 x 0.8	



## In-Line QuadPower Drawer Connector Pin Side Layout Form

### Pin Assembly

1. Enter company and contact information (at right).
2. Write the total quantity of each pin contact you require **for each pin assembly** in the **Qty** column of the **Pin Contact Selection Menu** table.
3. Crimp contacts are shipped uninstalled. Threaded contacts are installed by Tyco Electronics; enter the letter reference of the desired threaded contact in the appropriate contact positions on the drawing: e.g., if you need a size #0 M6 x 1 external thread contact to be installed in contact position #1, write "H" in circle #1.
4. Sign, date and send the completed form to your local Tyco Electronics Sales Engineer.

ENTER CUSTOMER INFORMATION	
Company	Location
Contact Name	Title
Telephone	Fax
Email Address	
I am: <input type="checkbox"/> End user <input type="checkbox"/> Contract manufacturer (end user: _____ )	
Signature	Today's Date
	Annual Quantity Required

Submit to your local Tyco Electronics Sales Engineer.

**Pin Connector (Rear Face)**  
Pin Contact Insertion Side  
Pin Connector Rear Face Cavity Identification

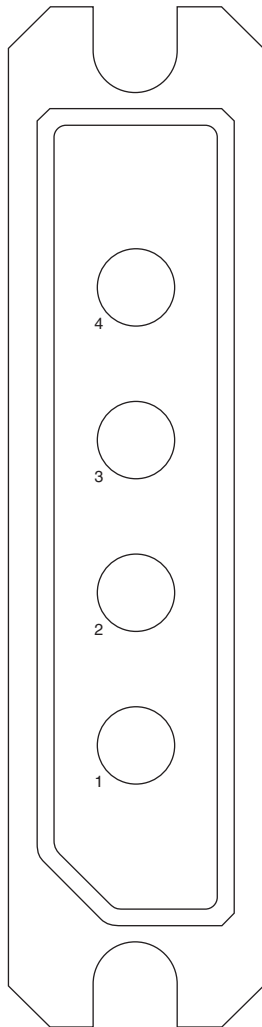

Pin Housing Part Number
1651493-1

Pin Contact Selection Menu				
Size	Ref.	Part Number	Termination Style & Pin Length	Qty.
<b>#0</b>	A =	1766811-1	Crimp	
	B =	1766819-1	Probe Proof, crimp	
	C =	1766230-1	1/4-20 Internal Thread	
	D =	1766274-1	M6 x 1 Internal Thread	
	E =	1766269-1	Probe Proof, 1/4-20 Internal Thread	
	F =	1766275-1	Probe Proof, M6 x 1 Internal Thread	
	G =	1766268-1	1/4-20 External Thread	
	H =	1766231-1	M6 x 1 External Thread	
	J =	1766270-1	Probe Proof, 1/4-20 External Thread	
K =	1766276-1	Probe Proof, M6 x 1 External Thread		

Contacts are removable.

Float Mount Shoulder Screw		
Part Number	Description	Qty.
1650399-1	Screw, No 10-32 UNC 2A	
1650401-1	Screw, M5 x 0.8	

**Top Assembly Part Number  
Assigned by Tyco Electronics**

AMP, ELCON, TE LOGO and TYCO ELECTRONICS are trademarks of Tyco Electronics Corporation.

## In-Line QuadPower Drawer Connector Socket Side Layout Form

### Socket Assembly

1. Enter company and contact information (at right).
2. Write the total quantity of each socket contact you require for each socket assembly in the Qty column of the Socket Contact Selection Menu table.
3. Crimp contacts are shipped uninstalled. Threaded contacts are installed by Tyco Electronics; enter the letter reference of the desired threaded contact in the appropriate contact positions on the drawing: e.g., if you need a size #0 M6 x 1 external thread contact to be installed in contact position #1, write "H" in circle #1.
4. Sign, date and send the completed form to your local Tyco Electronics Sales Engineer.

ENTER CUSTOMER INFORMATION	
Company	Location
Contact Name	Title
Telephone	Fax
Email Address	
I am: <input type="checkbox"/> End user <input type="checkbox"/> Contract manufacturer (end user: _____)	
Signature	Today's Date
	Annual Quantity Required

Submit to your local Tyco Electronics Sales Engineer.

**Socket Connector (Rear Face)**  
Socket Contact Insertion Side  
Socket Connector Rear Face Cavity Identification

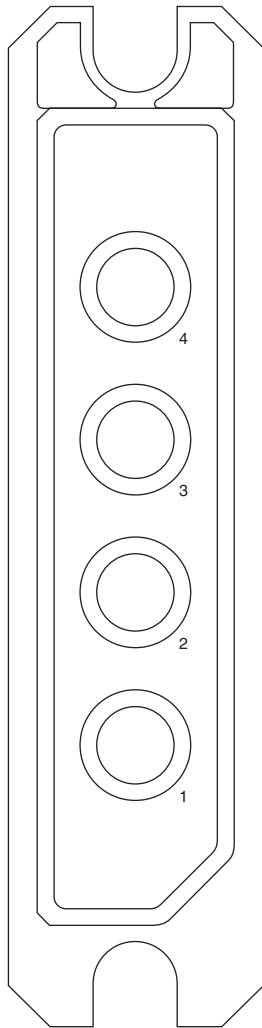

Socket Housing Part Number
1651404-1

Socket Contact Selection Menu				
Size	Ref.	Part Number	Termination Style & Pin Length	Qty.
#0	A =	6648405-1	Crimp	
	B =	6648418-1	Probe Proof, crimp	
	C =	6648416-1	1/4-20 Internal Thread	
	D =	6648428-1	M6 x 1 Internal Thread	
	E =	6648419-1	Probe Proof, 1/4-20 Internal Thread	
	F =	6648429-1	Probe Proof, M6 x 1 Internal Thread	
	G =	6648417-1	1/4-20 External Thread	
	H =	6648430-1	M6 x 1 External Thread	
	J =	6648420-1	Probe Proof, 1/4-20 External Thread	
	K =	6648431-1	Probe Proof, M6 x 1 External Thread	

Contacts are removable.

Float Mount Shoulder Screw		
Part Number	Description	Qty.
1650399-1	Screw, No 10-32 UNC 2A	
1650401-1	Screw, M5 x 0.8	

**Top Assembly Part Number  
Assigned by Tyco Electronics**

AMP, ELCON, TE LOGO and TYCO ELECTRONICS are trademarks of Tyco Electronics Corporation.

## W5 Power Drawer Connector Pin Side Layout Form

### Pin Assembly

1. Enter company and contact information (at right).
2. Write the total quantity of each pin contact you require **for each pin assembly** in the **Qty** column of the **Pin Contact Selection Menu** table.
3. Crimp contacts are shipped uninstalled. Threaded contacts are installed by Tyco Electronics; enter the letter reference of the desired threaded contact in the appropriate contact positions on the drawing: e.g., if you need a size #4 1/4-20 external thread contact to be installed in contact position #1, write "B" in circle #1.
4. Sign, date and send the completed form to your local Tyco Electronics Sales Engineer.

ENTER CUSTOMER INFORMATION	
Company	Location
Contact Name	Title
Telephone	Fax
Email Address	
I am: <input type="checkbox"/> End user <input type="checkbox"/> Contract manufacturer (end user: _____)	
Signature	Today's Date
	Annual Quantity Required

Submit to your local Tyco Electronics Sales Engineer.

**Pin Connector (Rear Face)**  
Pin Contact Insertion Side  
Pin Connector Rear Face Cavity Identification

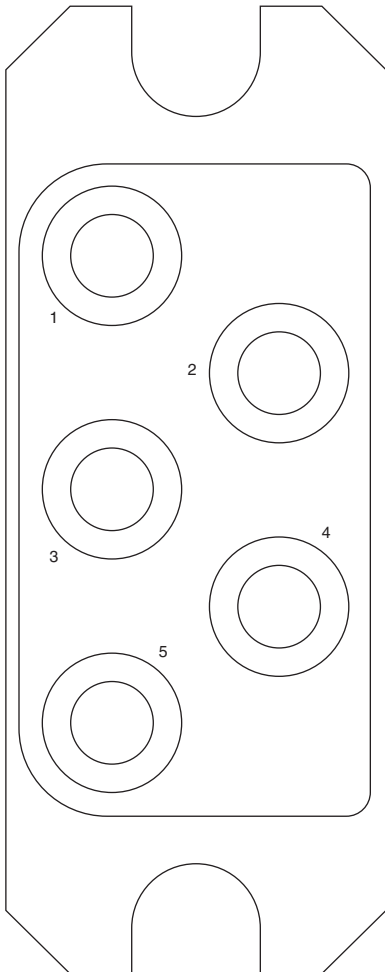

Pin Housing Part Number
6651457-1

Pin Contact Selection Menu				
Size	Ref.	Part Number	Termination Style & Pin Length	Qty.
<b>#4</b>	A =	1766232-1	Crimp, standard	
	B =	1766812-1	1/4-20 External Thread	
	C =	1766283-1	M5 Internal Thread	

Contacts are removable.

Float Mount Shoulder Screw		
Part Number	Description	Qty.
1650402-1	Screw, No 8-32 UNC 2A	
1650589-1	Screw, M4 x 0.7	

**Top Assembly Part Number  
Assigned by Tyco Electronics**

AMP, ELCON, TE LOGO and TYCO ELECTRONICS are trademarks of Tyco Electronics Corporation.

## W5 Power Drawer Connector Socket Side Layout Form

### Socket Assembly

1. Enter company and contact information (at right).
2. Write the total quantity of each socket contact you require **for each socket assembly** in the **Qty** column of the **Socket Contact Selection Menu** table.
3. Crimp contacts are shipped uninstalled. Threaded contacts are installed by Tyco Electronics; enter the letter reference of the desired threaded contact in the appropriate contact positions on the drawing: e.g., if you need a size #4 1/2-20 external thread contact to be installed in contact position #1, write "B" in circle #1.
4. Sign, date and send the completed form to your local Tyco Electronics Sales Engineer.

ENTER CUSTOMER INFORMATION	
Company	Location
Contact Name	Title
Telephone	Fax
Email Address	
I am: <input type="checkbox"/> End user <input type="checkbox"/> Contract manufacturer (end user: _____)	
Signature	Today's Date
	Annual Quantity Required

Submit to your local Tyco Electronics Sales Engineer.

**Socket Connector (Rear Face)**  
Socket Contact Insertion Side  
Socket Connector Rear Face Cavity Identification

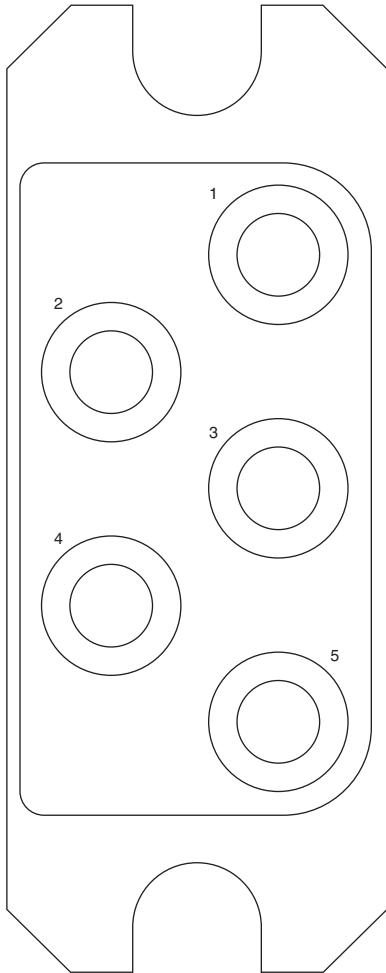

Socket Housing Part Number
6651458-1

Socket Contact Selection Menu				
Size	Ref.	Part Number	Termination Style & Pin Length	Qty.
<b>#4</b>	A =	6648434-1	Crimp, standard	
	B =	6648435-1	1/4-20 External Thread	
	C =	6648335-1	M5 Internal Thread	

Contacts are removable.

Float Mount Shoulder Screw		
Part Number	Description	Qty.
1650402-1	Screw, No 8-32 UNC 2A	
1650589-1	Screw, M4 x 0.7	

**Top Assembly Part Number  
Assigned by Tyco Electronics**

AMP, ELCON, TE LOGO and TYCO ELECTRONICS are trademarks of Tyco Electronics Corporation.

**HV8P Drawer Connector Pin Side Layout Form**

**Pin Assembly**

1. Enter company and contact information (at right).
2. Write the total quantity of each pin contact you require **for each pin assembly** in the **Qty** column of the **Pin Contact Selection Menu** table.
3. Crimp contacts are shipped uninstalled. PCB tail contacts are installed by Tyco Electronics; enter the letter reference of the desired contact in the appropriate contact positions on the drawing: e.g., if you need a non-hot plug size #12 premate PCB tail contact to be installed in contact position #8, write "E" in circle #8.
4. Sign, date and send the completed form to your local Tyco Electronics Sales Engineer.

ENTER CUSTOMER INFORMATION	
Company	Location
Contact Name	Title
Telephone	Fax
Email Address	
I am: <input type="checkbox"/> End user <input type="checkbox"/> Contract manufacturer (end user: _____)	
Signature	Today's Date
	Annual Quantity Required

Submit to your local Tyco Electronics Sales Engineer.

**Pin Connector (Rear Face)**  
Pin Contact Insertion Side  
Pin Connector Rear Face Cavity Identification

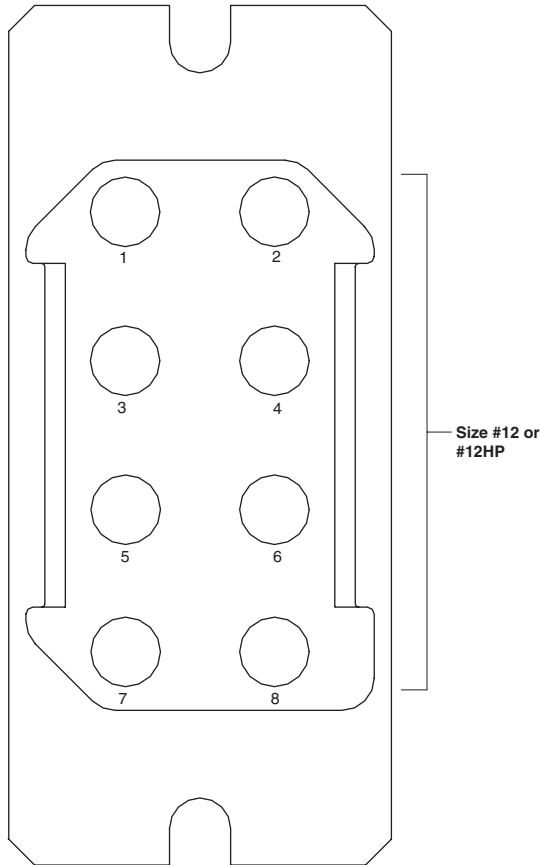

Pin Housing Part Number
1648127-1 = Fixed Mount

Pin Contact Selection Menu				
Size	Ref.	Part Number	Termination Style & Pin Length	Qty.
#12	A =	1766193-1	Crimp, standard	
	B =	1766195-1	Crimp, premate	
	C =	1766196-1	Crimp, postmate	
	D =	1766245-1	PCB tail, standard	
	E =	1766250-1	PCB tail, premate	
	F =	1766249-1	PCB tail, postmate	
#12 Hot Plug	G =	1650153-2	Crimp, standard, Hot Plug	
	H =	1650156-2	Crimp, premate, Hot Plug	
	J =	1650060-2	PCB tail, standard, Hot Plug	
	K =	1650074-3	PCB tail, premate, Hot Plug	

Crimp contacts are removable. PCB tail contacts are non-removable.

**Top Assembly Part Number Assigned by Tyco Electronics**



**HV8P Drawer Connector Socket Side Layout Form**

**Socket Assembly**

1. Enter company and contact information (at right).
2. Write the total quantity of each socket contact you require for each socket assembly in the Qty column of the Socket Contact Selection Menu table.
3. Crimp contacts are shipped uninstalled. Press-fit and PCB tail contacts are installed by Tyco Electronics; enter the letter reference of the desired contact in the appropriate contact positions on the drawing: e.g., if you need a non-hot plug size #12 PCB tail contact to be installed in contact position #8, write "C" in circle #8.
4. Sign, date and send the completed form to your local Tyco Electronics Sales Engineer.

ENTER CUSTOMER INFORMATION	
Company	Location
Contact Name	Title
Telephone	Fax
Email Address	
I am: <input type="checkbox"/> End user <input type="checkbox"/> Contract manufacturer (end user: _____)	
Signature	Today's Date
	Annual Quantity Required

Submit to your local Tyco Electronics Sales Engineer.

**Socket Connector (Rear Face)**  
Socket Contact Insertion Side  
Socket Connector Rear Face Cavity Identification

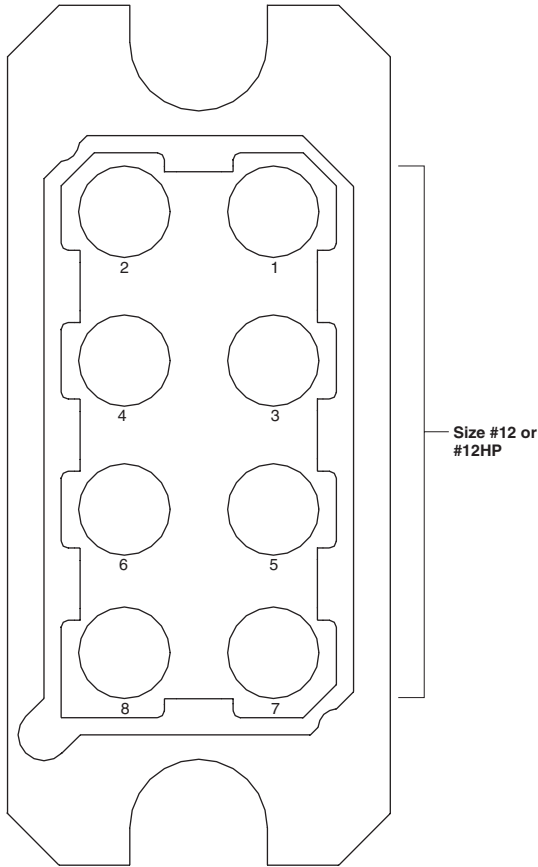

Socket Housing Part Number
1648128-1 = Float Mount

Socket Contact Selection Menu				
Size	Ref.	Part Number	Termination Style & Pin Length	Qty.
#12	A =	6648318-1	Crimp	
	B =	6648304-1	Compliant Press-fit	
	C =	6648374-1	PCB Tail	
#12 Hot Plug	D =	1648384-1	Crimp, Hot Plug	
	E =	6648305-1	Compliant Press-fit, Hot Plug	
	F =	1648387-1	PCB Tail, Hot Plug	

Crimp contacts are removable. Press-fit and PCB tail contacts are non-removable.

Float Mount Shoulder Screw		
Part Number	Description	Qty.
1650402-1	Screw, No 8-32 UNC 2A	
1650589-1	Screw, M4 x 0.7	

**Top Assembly Part Number**  
Assigned by Tyco Electronics

AMP, ELCON, TE LOGO and TYCO ELECTRONICS are trademarks of Tyco Electronics Corporation.

**P10S0 Drawer Connector Pin Side Layout Form**

**Pin Assembly**

1. Enter company and contact information (at right).
2. Write the total quantity of each pin contact you require **for each pin assembly** in the **Qty** column of the **Pin Contact Selection Menu** table.
3. Crimp contacts are shipped uninstalled. PCB tail contacts are installed by Tyco Electronics; enter the letter reference of the desired contact in the appropriate contact positions on the drawing: e.g., if you need a hot plug size #12 premate PCB tail contact to be installed in contact position #10, write "K" in circle #10.
4. Sign, date and send the completed form to your local Tyco Electronics Sales Engineer.

ENTER CUSTOMER INFORMATION	
Company	Location
Contact Name	Title
Telephone	Fax
Email Address	
I am: <input type="checkbox"/> End user <input type="checkbox"/> Contract manufacturer (end user: _____)	
Signature	Today's Date
	Annual Quantity Required

Submit to your local Tyco Electronics Sales Engineer.

**Pin Connector (Rear Face)**  
Pin Contact Insertion Side  
Pin Connector Rear Face Cavity Identification

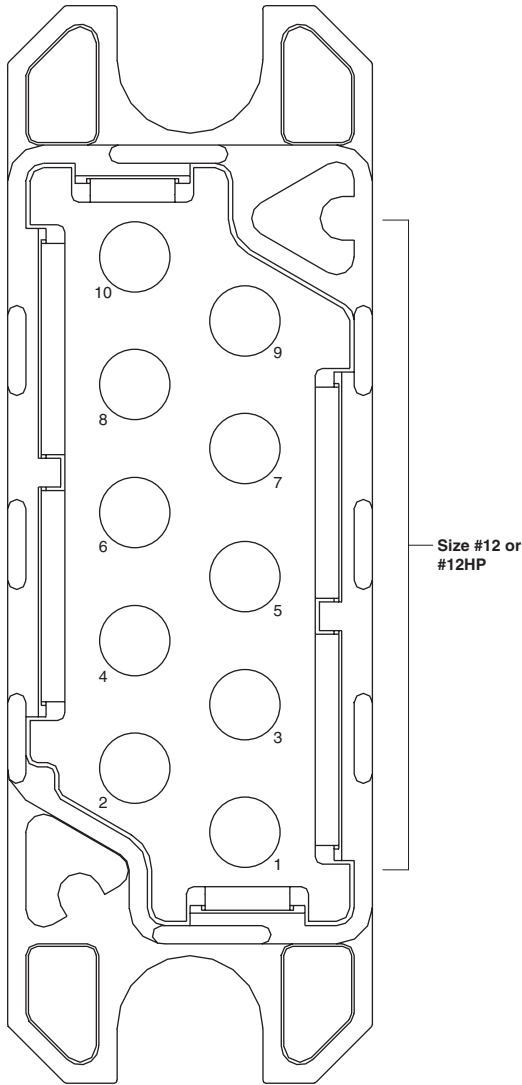

Pin Housing Part Number
1648568-1

Pin Contact Selection Menu				
Size	Ref.	Part Number	Termination Style & Pin Length	Qty.
#12	A =	1766193-1	Crimp, standard	
	B =	1766195-1	Crimp, premate	
	C =	1766196-1	Crimp, postmate	
	D =	1766245-1	PCB tail, standard	
	E =	1766250-1	PCB tail, premate	
	F =	1766249-1	PCB tail, postmate	
#12 Hot Plug	G =	1650153-2	Crimp, standard, Hot Plug	
	H =	1650156-2	Crimp, premate, Hot Plug	
	J =	1650060-2	PCB tail, standard, Hot Plug	
	K =	1650074-3	PCB tail, premate, Hot Plug	

Crimp contacts are removable. PCB tail contacts are non-removable.

Float Mount Shoulder Screw		
Part Number	Description	Qty.
1650402-1	Screw, No 8-32 UNC 2A	
1650589-1	Screw, M4 x 0.7	

**Top Assembly Part Number Assigned by Tyco Electronics**

AMP, ELCON, TE LOGO and TYCO ELECTRONICS are trademarks of Tyco Electronics Corporation.

**P10S0 Drawer Connector Socket Side Layout Form**

**Socket Assembly**

1. Enter company and contact information (at right).
2. Write the total quantity of each socket contact you require for each socket assembly in the Qty column of the Socket Contact Selection Menu table.
3. Crimp contacts are shipped uninstalled. Press-fit and PCB tail contacts are installed by Tyco Electronics; enter the letter reference of the desired contact in the appropriate contact positions on the drawing: e.g., if you need a hot plug size #12 PCB tail contact to be installed in contact position #10, write "F" in circle #10.
4. Sign, date and send the completed form to your local Tyco Electronics Sales Engineer.

ENTER CUSTOMER INFORMATION	
Company	Location
Contact Name	Title
Telephone	Fax
Email Address	
I am: <input type="checkbox"/> End user <input type="checkbox"/> Contract manufacturer (end user: _____)	
Signature	Today's Date
	Annual Quantity Required

Submit to your local Tyco Electronics Sales Engineer.

**Socket Connector (Rear Face)**  
Socket Contact Insertion Side  
Socket Connector Rear Face Cavity Identification

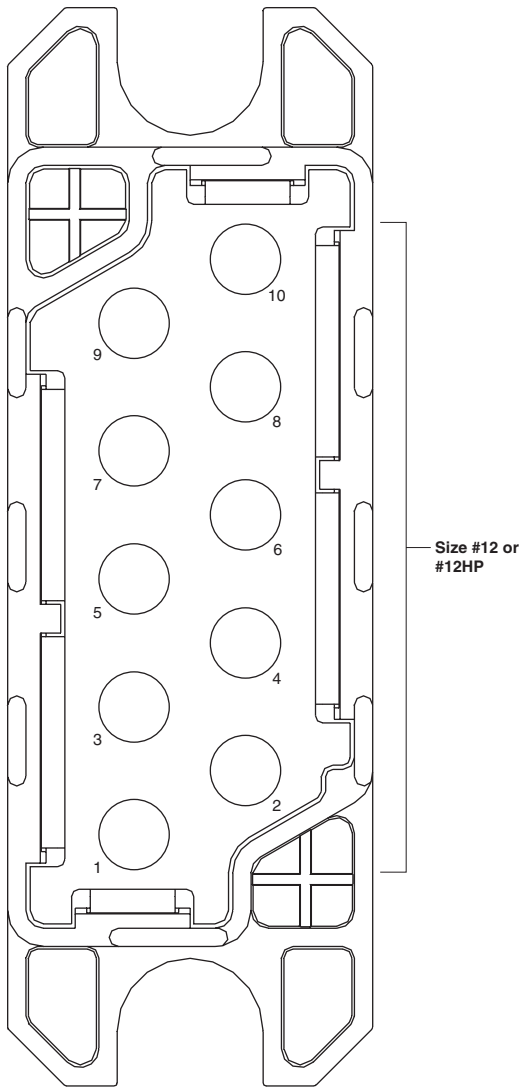

Socket Housing Part Number
1648596-1

Socket Contact Selection Menu				
Size	Ref.	Part Number	Termination Style & Pin Length	Qty.
#12	A =	6648318-1	Crimp	
	B =	6648304-1	Compliant Press-fit	
	C =	6648374-1	PCB Tail	
#12 Hot Plug	D =	1648384-1	Crimp, Hot Plug	
	E =	6648305-1	Compliant Press-fit, Hot Plug	
	F =	1648387-1	PCB Tail, Hot Plug	

Crimp contacts are removable. Press-fit and PCB tail contacts are non-removable.

Float Mount Shoulder Screw		
Part Number	Description	Qty.
1650402-1	Screw, No 8-32 UNC 2A	
1650589-1	Screw, M4 x 0.7	

**Top Assembly Part Number Assigned by Tyco Electronics**

AMP, ELCON, TE LOGO and TYCO ELECTRONICS are trademarks of Tyco Electronics Corporation.

## P10S22 Drawer Connector Pin Side Layout Form

### Pin Assembly

1. Enter company and contact information (at right).
2. Write the total quantity of each pin contact you require **for each pin assembly** in the **Qty** column of the **Pin Contact Selection Menu** table.
3. Crimp contacts are shipped uninstalled. PCB tail contacts are installed by Tyco Electronics; enter the letter reference of the desired contact in the appropriate contact positions on the drawing: e.g., if you need a non-hot plug size #12 standard PCB tail contact to be installed in contact position #1, write "K" in circle #1.
4. Sign, date and send the completed form to your local Tyco Electronics Sales Engineer.

**Pin Connector (Rear Face)**  
Pin Contact Insertion Side  
Pin Connector Rear Face Cavity Identification

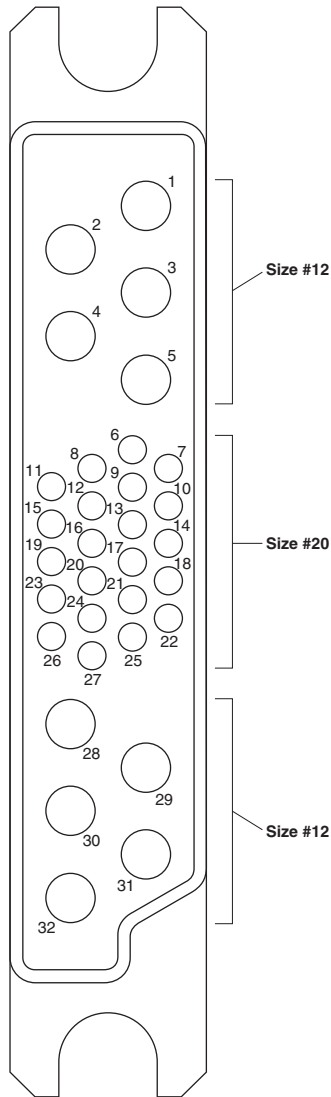

ENTER CUSTOMER INFORMATION	
Company	Location
Contact Name	Title
Telephone	Fax
Email Address	
I am: <input type="checkbox"/> End user <input type="checkbox"/> Contract manufacturer (end user: _____)	
Signature	Today's Date
	Annual Quantity Required

Submit to your local Tyco Electronics Sales Engineer.

Pin Housing Part Number
1648211-1

Pin Contact Selection Menu				
Size	Ref.	Part Number	Termination Style & Pin Length	Qty.
#20	A =	1650155-1	Crimp, standard	
	B =	1650161-1	Crimp, premate	
	C =	1650162-2	Crimp, postmate	
	D =	1650283-1	PCB tail, standard	
	E =	1650065-1	PCB tail, premate	
	F =	1650226-1	PCB tail, postmate	
#12	G =	1766193-1	Crimp, standard	
	H =	1766195-1	Crimp, premate	
	J =	1766196-1	Crimp, postmate	
	K =	1766245-1	PCB tail, standard	
	L =	1766250-1	PCB tail, premate	
	M =	1766249-1	PCB tail, postmate	
#12 Hot Plug	N =	1650153-2	Crimp, standard, Hot Plug	
	P =	1650156-2	Crimp, premate, Hot Plug	
	Q =	1650060-2	PCB tail, standard, Hot Plug	
	R =	1650074-3	PCB tail, premate, Hot Plug	

Crimp contacts are removable. PCB tail contacts are non-removable.

Float Mount Shoulder Screw		
Part Number	Description	Qty.
1650402-1	Screw, No 8-32 UNC 2A	
1650589-1	Screw, M4 x 0.7	

**Top Assembly Part Number**  
Assigned by Tyco Electronics

AMP, ELCON, TE LOGO and TYCO ELECTRONICS are trademarks of Tyco Electronics Corporation.

**P10S22 Drawer Connector Socket Side Layout Form**

**Socket Assembly**

1. Enter company and contact information (at right).
2. Write the total quantity of each socket contact you require **for each socket assembly** in the **Qty** column of the **Socket Contact Selection Menu** table.
3. Crimp contacts are shipped uninstalled. Press-fit and PCB tail contacts are installed by Tyco Electronics; enter the letter reference of the desired contact in the appropriate contact positions on the drawing: e.g., if you need a non-hot plug size #12 PCB tail contact to be installed in contact position #1, write "F" in circle #1.
4. Sign, date and send the completed form to your local Tyco Electronics Sales Engineer.

**Socket Connector (Rear Face)**  
Socket Contact Insertion Side  
Socket Connector Rear Face Cavity Identification

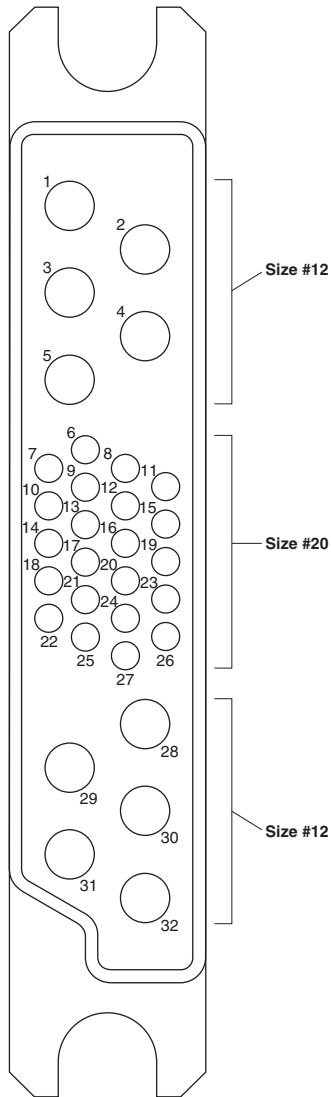

ENTER CUSTOMER INFORMATION	
Company	Location
Contact Name	Title
Telephone	Fax
Email Address	
I am: <input type="checkbox"/> End user <input type="checkbox"/> Contract manufacturer (end user: _____)	
Signature	Today's Date
	Annual Quantity Required

Submit to your local Tyco Electronics Sales Engineer.

Socket Housing Part Number
1648212-1

Socket Contact Selection Menu				
Size	Ref.	Part Number	Termination Style & Pin Length	Qty.
#20	A =	1648325-1	Crimp	
	B =	6648301-1	Compliant Press-fit	
	C =	1648382-1	PCB Tail	
#12	D =	6648318-1	Crimp	
	E =	6648304-1	Compliant Press-fit	
	F =	6648374-1	PCB Tail	
#12 Hot Plug	G =	1648384-1	Crimp, Hot Plug	
	H =	6648305-1	Compliant Press-fit, Hot Plug	
	J =	1648387-1	PCB Tail, Hot Plug	

Crimp contacts are removable. Press-fit and PCB tail contacts are non-removable.

Float Mount Shoulder Screw		
Part Number	Description	Qty.
1650402-1	Screw, No 8-32 UNC 2A	
1650589-1	Screw, M4 x 0.7	

**Top Assembly Part Number**  
Assigned by Tyco Electronics

AMP, ELCON, TE LOGO and TYCO ELECTRONICS are trademarks of Tyco Electronics Corporation.



## P12S12 Drawer Connector Pin Side Layout Form

### Pin Assembly

1. Enter company and contact information (at right).
2. Write the total quantity of each pin contact you require **for each pin assembly** in the **Qty** column of the **Pin Contact Selection Menu** table.
3. Crimp contacts are shipped uninstalled. PCB tail contacts are installed by Tyco Electronics; enter the letter reference of the desired contact in the appropriate contact positions on the drawing: e.g., if you need a size #20 premate PCB tail contact to be installed in contact position #9, write "E" in circle #9.
4. Sign, date and send the completed form to your local Tyco Electronics Sales Engineer.

**Pin Connector (Rear Face)**  
Pin Contact Insertion Side  
Pin Connector Rear Face Cavity Identification

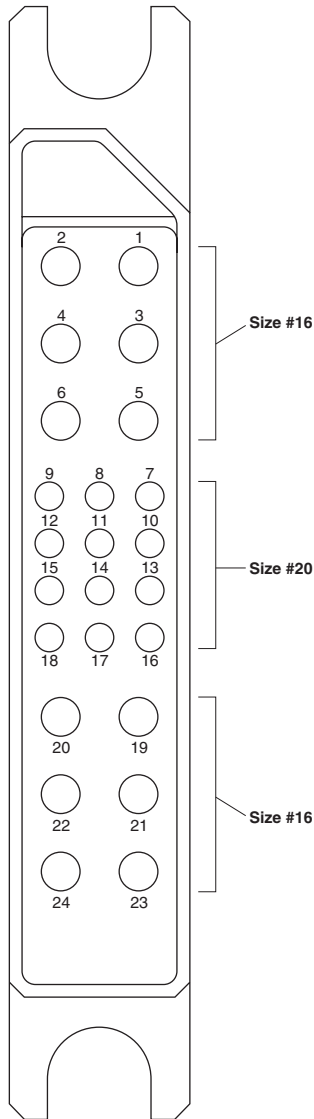

ENTER CUSTOMER INFORMATION	
Company	Location
Contact Name	Title
Telephone	Fax
Email Address	
I am: <input type="checkbox"/> End user <input type="checkbox"/> Contract manufacturer (end user: _____)	
Signature	Today's Date
	Annual Quantity Required

Submit to your local Tyco Electronics Sales Engineer.

Pin Housing Part Number
1651202-1

Pin Contact Selection Menu				
Size	Ref.	Part Number	Termination Style & Pin Length	Qty.
#20	A =	1650155-1	Crimp, standard	
	B =	1650161-1	Crimp, premate	
	C =	1650162-2	Crimp, postmate	
	D =	1650283-1	PCB tail, standard	
	E =	1650065-1	PCB tail, premate	
	F =	1650226-1	PCB tail, postmate	
#16	G =	1766194-1	Crimp, standard	
	H =	1766198-1	Crimp, premate	
	J =	1766199-1	Crimp, postmate	
	K =	1766222-1	PCB tail, standard	
	L =	1766223-1	PCB tail, premate	
	M =	1766818-1	PCB tail, postmate	

Crimp contacts are removable. PCB tail contacts are non-removable.

Float Mount Shoulder Screw		
Part Number	Description	Qty.
1650402-1	Screw, No 8-32 UNC 2A	
1650589-1	Screw, M4 x 0.7	

**Top Assembly Part Number  
Assigned by Tyco Electronics**

AMP, ELCON, TE LOGO and TYCO ELECTRONICS are trademarks of Tyco Electronics Corporation.

**P12S12 Drawer Connector Socket Side Layout Form**

**Socket Assembly**

1. Enter company and contact information (at right).
2. Write the total quantity of each socket contact you require **for each socket assembly** in the **Qty** column of the **Socket Contact Selection Menu** table.
3. Crimp contacts are shipped uninstalled. Press-fit and PCB tail contacts are installed by Tyco Electronics; enter the letter reference of the desired contact in the appropriate contact positions on the drawing: e.g., if you need a size #20 PCB tail contact to be installed in contact position #9, write "C" in circle #9.
4. Sign, date and send the completed form to your local Tyco Electronics Sales Engineer.

**Socket Connector (Rear Face)**  
Socket Contact Insertion Side  
Socket Connector Rear Face Cavity Identification

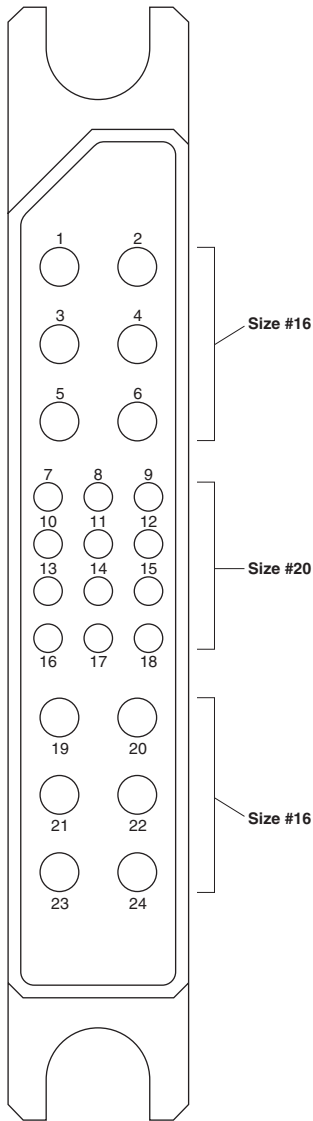

ENTER CUSTOMER INFORMATION	
Company	Location
Contact Name	Title
Telephone	Fax
Email Address	
I am: <input type="checkbox"/> End user <input type="checkbox"/> Contract manufacturer (end user: _____)	
Signature	Today's Date
	Annual Quantity Required

Submit to your local Tyco Electronics Sales Engineer.

Socket Housing Part Number
1651203-1

Socket Contact Selection Menu				
Size	Ref.	Part Number	Termination Style & Pin Length	Qty.
#20	A =	1648325-1	Crimp	
	B =	6648301-1	Compliant Press-fit	
	C =	1648382-1	PCB Tail	
#16	D =	6648319-1	Crimp	
	E =	6648306-1	Compliant Press-fit	
	F =	6648383-1	PCB Tail	

Crimp contacts are removable. Press-fit and PCB tail contacts are non-removable.

Float Mount Shoulder Screw		
Part Number	Description	Qty.
1650402-1	Screw, No 8-32 UNC 2A	
1650589-1	Screw, M4 x 0.7	

**Top Assembly Part Number Assigned by Tyco Electronics**

AMP, ELCON, TE LOGO and TYCO ELECTRONICS are trademarks of Tyco Electronics Corporation.

## POS30 Drawer Connector Pin Side Layout Form

### Pin Assembly

1. Enter company and contact information (at right).
2. Write the total quantity of each pin contact you require **for each pin assembly** in the **Qty** column of the **Pin Contact Selection Menu** table.
3. Crimp contacts are shipped uninstalled. PCB tail contacts are installed by Tyco Electronics; enter the letter reference of the desired contact in the appropriate contact positions on the drawing: e.g., if you need a size #20 premate PCB tail contact to be installed in contact position #1, write "E" in circle #1.
4. Sign, date and send the completed form to your local Tyco Electronics Sales Engineer.

**Pin Connector (Rear Face)**  
 Pin Contact Insertion Side  
 Pin Connector Rear Face Cavity Identification

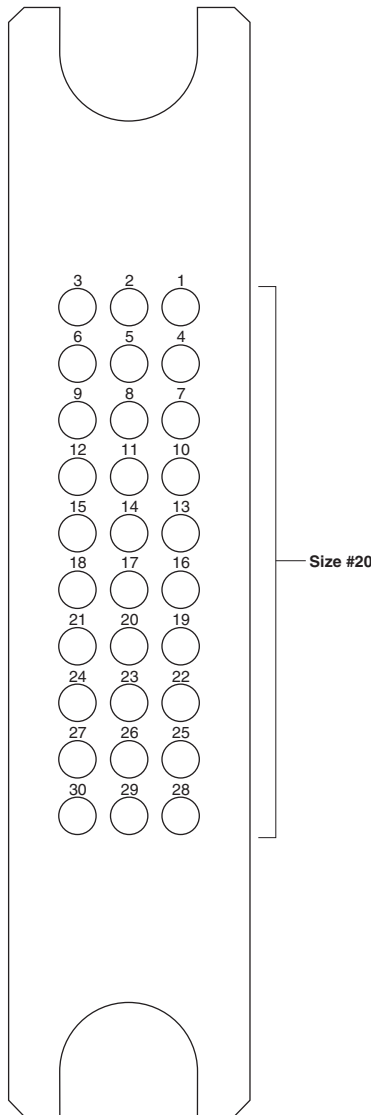

ENTER CUSTOMER INFORMATION	
Company	Location
Contact Name	Title
Telephone	Fax
Email Address	
I am: <input type="checkbox"/> End user <input type="checkbox"/> Contract manufacturer (end user: _____)	
Signature	Today's Date
	Annual Quantity Required

Submit to your local Tyco Electronics Sales Engineer.

Pin Housing Part Number
6651204-1

Pin Contact Selection Menu				
Size	Ref.	Part Number	Termination Style & Pin Length	Qty.
#20	A =	1650155-1	Crimp, standard	
	B =	1650161-1	Crimp, premate	
	C =	1650162-2	Crimp, postmate	
	D =	1650283-1	PCB tail, standard	
	E =	1650065-1	PCB tail, premate	
	F =	1650226-1	PCB tail, postmate	

Crimp contacts are removable. PCB tail contacts are non-removable.

Float Mount Shoulder Screw		
Part Number	Description	Qty.
1650402-1	Screw, No 8-32 UNC 2A	
1650589-1	Screw, M4 x 0.7	

**Top Assembly Part Number  
 Assigned by Tyco Electronics**

AMP, ELCON, TE LOGO and TYCO ELECTRONICS are trademarks of Tyco Electronics Corporation.

## POS30 Drawer Connector Socket Side Layout Form

### Socket Assembly

1. Enter company and contact information (at right).
2. Write the total quantity of each socket contact you require **for each socket assembly** in the **Qty** column of the **Socket Contact Selection Menu** table.
3. Crimp contacts are shipped uninstalled. Press-fit and PCB tail contacts are installed by Tyco Electronics; enter the letter reference of the desired contact in the appropriate contact positions on the drawing: e.g., if you need a size #20 PCB tail contact to be installed in contact position #1, write "C" in circle #1.
4. Sign, date and send the completed form to your local Tyco Electronics Sales Engineer.

**Socket Connector (Rear Face)**  
 Socket Contact Insertion Side  
 Socket Connector Rear Face Cavity Identification

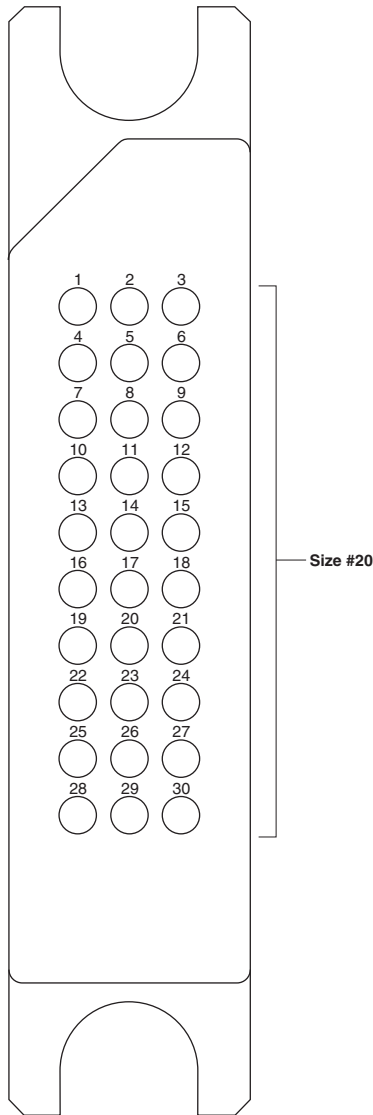

ENTER CUSTOMER INFORMATION	
Company	Location
Contact Name	Title
Telephone	Fax
Email Address	
I am: <input type="checkbox"/> End user <input type="checkbox"/> Contract manufacturer (end user: _____)	
Signature	Today's Date
	Annual Quantity Required

Submit to your local Tyco Electronics Sales Engineer.

Socket Housing Part Number
6651205-1

Socket Contact Selection Menu				
Size	Ref.	Part Number	Termination Style & Pin Length	Qty.
#20	A =	1648325-1	Crimp	
	B =	6648301-1	Compliant Press-fit	
	C =	1648382-1	PCB Tail	

Crimp contacts are removable. Press-fit and PCB tail contacts are non-removable.

Float Mount Shoulder Screw		
Part Number	Description	Qty.
1650402-1	Screw, No 8-32 UNC 2A	
1650589-1	Screw, M4 x 0.7	

**Top Assembly Part Number**  
 Assigned by Tyco Electronics

AMP, ELCON, TE LOGO and TYCO ELECTRONICS are trademarks of Tyco Electronics Corporation.

**Tyco Electronics Corporation**  
Harrisburg, PA

[tycoelectronics.com](http://tycoelectronics.com)

6-1773444-7-LUG-PDF-10-07

