

# TMPIM 25 A CIB Module

## NXH25C120L2C2SG

The NXH25C120L2C2SG is a transfer-molded power module containing a converter-inverter-brake circuit consisting of six 25 A, 1600 V rectifiers, six 25 A, 1200 V IGBTs with inverse diodes, one 25 A, 1200 V brake IGBT with brake diode and an NTC thermistor.

### Features

- Low Thermal Resistance
- 6 mm Clearance Distance between Pin to Heatsink
- Compact 73 mm × 40 mm × 8 mm Package
- Solderable Pins
- Thermistor
- These Devices are Pb-Free, Halogen Free/BFR Free and are RoHS Compliant

### Typical Applications

- Industrial Motor Drives
- Servo Drives

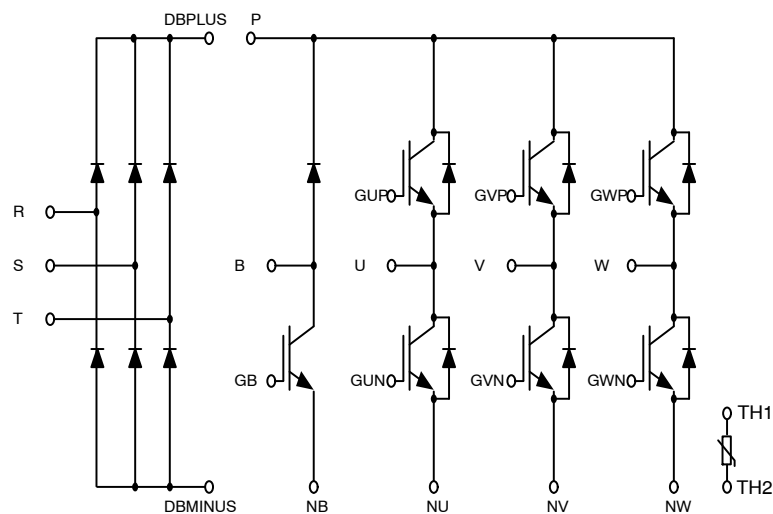
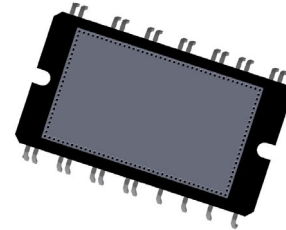

Figure 1. NXH25C120L2C2SG Schematic Diagram



ON Semiconductor®

[www.onsemi.com](http://www.onsemi.com)



DIP26 67.8x40  
CASE 181AD

### MARKING DIAGRAM

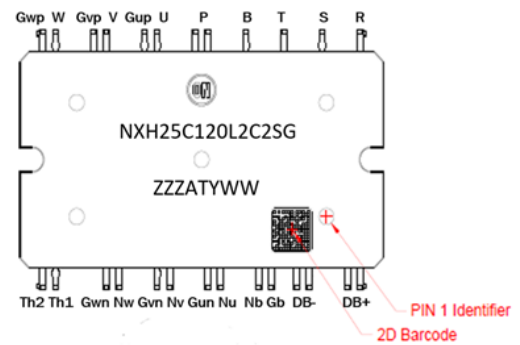

NXH25C120L2C2SG = Specific Device Code  
 ZZZ = Assembly Lot Code  
 AT = Assembly & Test Location  
 Y = Year  
 WW = Work Week

### ORDERING INFORMATION

Device	Package	Shipping†
NXH25C120L2C2SG	DIP26 (Pb-Free)	6 Units / Tube

# NXH25C120L2C2SG

## MAXIMUM RATINGS

Rating	Symbol	Value	Unit
--------	--------	-------	------

### IGBT

Collector–Emitter Voltage	$V_{CES}$	1200	V
Gate–Emitter Voltage	$V_{GE}$	±20	V
Continuous Collector Current @ $T_C = 80^\circ\text{C}$ ( $T_{V_{Jmax}} = 175^\circ\text{C}$ )	$I_C$	25	A
Pulsed Collector Current	$I_{Cpulse}$	75	A

### DIODE

Peak Repetitive Reverse Voltage	$V_{RRM}$	1200	V
Continuous Forward Current @ $T_C = 80^\circ\text{C}$ ( $T_{V_{Jmax}} = 175^\circ\text{C}$ )	$I_F$	25	A
Repetitive Peak Forward Current	$I_{FRM}$	75	A

### RECTIFIER DIODE

Peak Repetitive Reverse Voltage	$V_{RRM}$	1600	V
Continuous Forward Current @ $T_C = 80^\circ\text{C}$ ( $T_{V_{Jmax}} = 150^\circ\text{C}$ )	$I_F$	25	A
Repetitive Peak Forward Current	$I_{FRM}$	75	A
$I^2t$ value (10 ms single half–sine wave) @ $25^\circ\text{C}$ (10 ms single half–sine wave) @ $150^\circ\text{C}$	$I^2t$	680 360	$\text{A}^2\text{t}$
Surge current (10 ms sin180°) @ $25^\circ\text{C}$	IFSM	370	A

### THERMAL PROPERTIES

Storage Temperature range	$T_{stg}$	–40 to 125	°C
---------------------------	-----------	------------	----

### INSULATION PROPERTIES

Isolation test voltage, t = 1 sec, 50 Hz	$V_{is}$	3000	$V_{RMS}$
Internal isolation		$\text{Al}_2\text{O}_3$	
Creepage distance		6.0	mm
Clearance distance		6.0	mm
Comperative Tracking Index	CTI	> 400	

Stresses exceeding those listed in the Maximum Ratings table may damage the device. If any of these limits are exceeded, device functionality should not be assumed, damage may occur and reliability may be affected.

1. Refer to ELECTRICAL CHARACTERISTICS, RECOMMENDED OPERATING RANGES and/or APPLICATION INFORMATION for Safe Operating parameters.

# NXH25C120L2C2SG

## ELECTRICAL CHARACTERISTICS (T<sub>J</sub> = 25°C unless otherwise specified)

Parameter	Test Conditions	Symbol	Min	Typ	Max	Unit	
<b>IGBT CHARACTERISTICS</b>							
Collector–Emitter Cutoff Current	V <sub>GE</sub> = 0 V, V <sub>CE</sub> = 1200 V	I <sub>CES</sub>	–	–	250	μA	
Collector–Emitter Saturation Voltage	V <sub>GE</sub> = 15 V, I <sub>C</sub> = 25 A, T <sub>J</sub> = 25°C	V <sub>CE(sat)</sub>	–	1.7	2.4	V	
	V <sub>GE</sub> = 15 V, I <sub>C</sub> = 25 A, T <sub>J</sub> = 150°C		–	1.9	–		
Gate–Emitter Threshold Voltage	V <sub>GE</sub> = V <sub>CE</sub> , I <sub>C</sub> = 3.04 mA	V <sub>GE(TH)</sub>	4.8	5.9	6.8	V	
Gate Leakage Current	V <sub>GE</sub> = 20 V, V <sub>CE</sub> = 0 V	I <sub>GES</sub>	–	–	400	nA	
Turn-on Delay Time	T <sub>J</sub> = 25 °C V <sub>CE</sub> = 600 V, I <sub>C</sub> = 25 A V <sub>GE</sub> = ±15 V, R <sub>G</sub> = 20 Ω	t <sub>d(on)</sub>	–	68	–	ns	
Rise Time		t <sub>r</sub>	–	63	–		
Turn-off Delay Time		t <sub>d(off)</sub>	–	235	–		
Fall Time		t <sub>f</sub>	–	48	–		
Turn-on Switching Loss per Pulse		E <sub>on</sub>	–	2200	–		μJ
Turn off Switching Loss per Pulse		E <sub>off</sub>	–	720	–		
Turn-on Delay Time	T <sub>J</sub> = 125°C V <sub>CE</sub> = 600 V, I <sub>C</sub> = 25 A V <sub>GE</sub> = ±15 V, R <sub>G</sub> = 20 Ω	t <sub>d(on)</sub>	–	72	–	ns	
Rise Time		t <sub>r</sub>	–	56	–		
Turn-off Delay Time		t <sub>d(off)</sub>	–	266	–		
Fall Time		t <sub>f</sub>	–	54	–		
Turn-on Switching Loss per Pulse		E <sub>on</sub>	–	3050	–		μJ
Turn off Switching Loss per Pulse		E <sub>off</sub>	–	1200	–		
Input Capacitance	V <sub>CE</sub> = 20 V, V <sub>GE</sub> = 0 V f = 100 kHz	C <sub>ies</sub>	–	6200	–	pF	
Output Capacitance		C <sub>oes</sub>	–	212	–		
Reverse Transfer Capacitance		C <sub>res</sub>	–	117	–		
Total Gate Charge	V <sub>CE</sub> = 600 V, I <sub>C</sub> = 25 A, V <sub>GE</sub> = 0 V ~ +15 V	Q <sub>g</sub>	–	269	–	nC	
Temperature under switching conditions		T <sub>vj op</sub>	–40		150	°C	
Thermal Resistance – chip-to-case		R <sub>thJC</sub>	–	0.54	–	°C/W	

## DIODE CHARACTERISTICS

Brake Diode Reverse Leakage Current	V <sub>R</sub> = 1200 V	I <sub>R</sub>	–	–	200	μA
Diode Forward Voltage	I <sub>F</sub> = 25 A, T <sub>J</sub> = 25°C	V <sub>F</sub>	–	1.9	2.6	V
	I <sub>F</sub> = 25 A, T <sub>J</sub> = 150°C		–	1.7	–	
Reverse Recovery Charge	T <sub>J</sub> = 25°C V <sub>CE</sub> = 600 V, I <sub>C</sub> = 25 A V <sub>GE</sub> = ±15 V, R <sub>G</sub> = 20 Ω	Q <sub>rr</sub>	–	1.35	–	μC
Peak Reverse Recovery Current		I <sub>RPM</sub>	–	16	–	A
Reverse Recovery Energy		E <sub>rr</sub>	–	350	–	μJ
Reverse Recovery Charge	T <sub>J</sub> = 150 °C V <sub>CE</sub> = 600 V, I <sub>C</sub> = 25 A V <sub>GE</sub> = ±15 V, R <sub>G</sub> = 20 Ω	Q <sub>rr</sub>	–	3.6	–	μC
Peak Reverse Recovery Current		I <sub>RPM</sub>	–	26	–	A
Reverse Recovery Energy		E <sub>rr</sub>	–	1050	–	μJ
Temperature under switching conditions		T <sub>vj op</sub>	–40		150	°C
Thermal Resistance – chip-to-case		R <sub>thJC</sub>	–	1.10	–	°C/W

# NXH25C120L2C2SG

## ELECTRICAL CHARACTERISTICS (T<sub>J</sub> = 25°C unless otherwise specified) (continued)

Parameter	Test Conditions	Symbol	Min	Typ	Max	Unit
-----------	-----------------	--------	-----	-----	-----	------

### RECTIFIER DIODE CHARACTERISTICS

Rectifier Reverse Leakage Current	V <sub>R</sub> = 1600 V	I <sub>R</sub>	–	–	200	μA
Rectifier Forward Voltage	I <sub>F</sub> = 25 A, T <sub>J</sub> = 25°C	V <sub>F</sub>	–	1	1.5	V
	I <sub>F</sub> = 35 A, T <sub>J</sub> = 150°C		–	1.1	–	
Temperature under switching conditions		T <sub>vj op</sub>	–40		150	°C
Thermal Resistance – chip-to-case		R <sub>thJC</sub>	–	0.86	–	°C/W

### THERMISTOR CHARACTERISTICS

Nominal resistance	T = 25°C	R <sub>25</sub>	–	5	–	kΩ
Nominal resistance	T = 100°C	R <sub>100</sub>	–	493.3	–	Ω
Deviation of R25		ΔR/R	–5	–	5	%
Power dissipation		P <sub>D</sub>	–	20	–	mW
Power dissipation constant			–	1.4	–	mW/K
B-value	B(25/50), tolerance ±2%		–	3375	–	K
B-value	B(25/100), tolerance ±2%		–	3433	–	K

Product parametric performance is indicated in the Electrical Characteristics for the listed test conditions, unless otherwise noted. Product performance may not be indicated by the Electrical Characteristics if operated under different conditions.

TYPICAL CHARACTERISTICS – INVERTER/BRAKE IGBT & DIODE

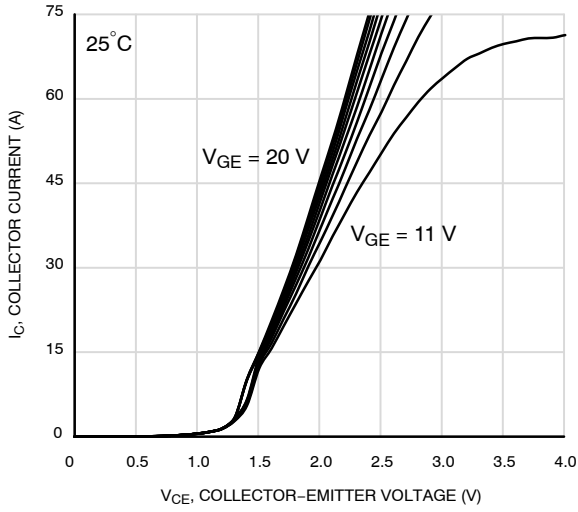

Figure 2. Inverter IGBT Typical Output Characteristic (25°C)

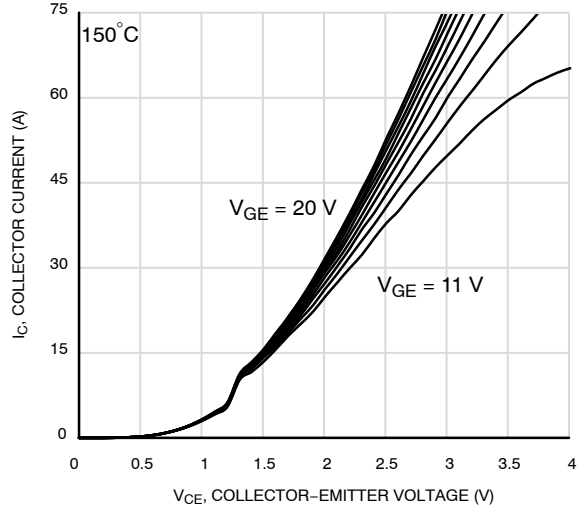

Figure 3. Inverter IGBT Typical Output Characteristic (150°C)

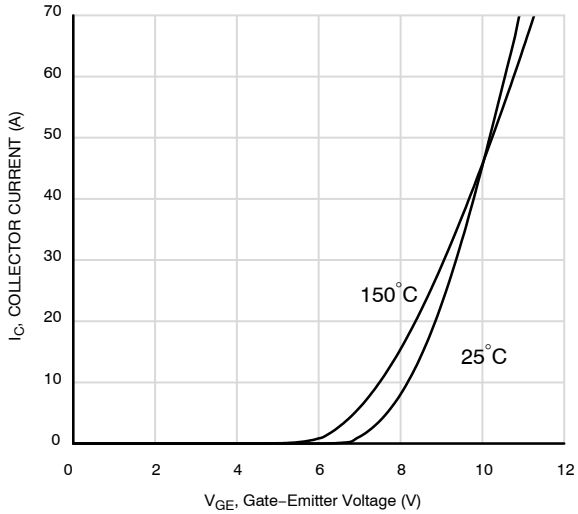

Figure 4. Inverter IGBT Typical Transfer Characteristic

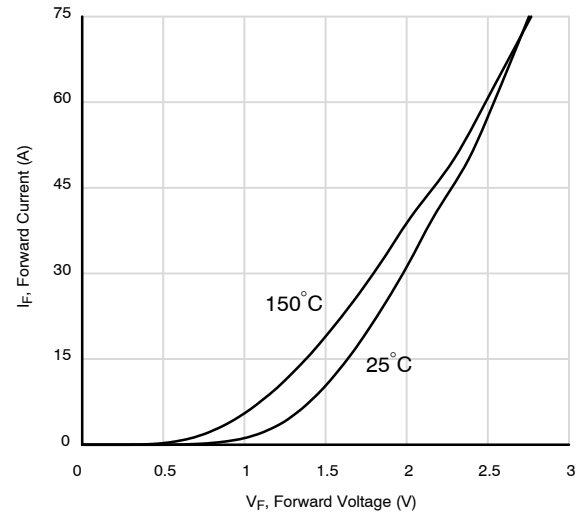

Figure 5. Inverter Diode Typical Forward Characteristic

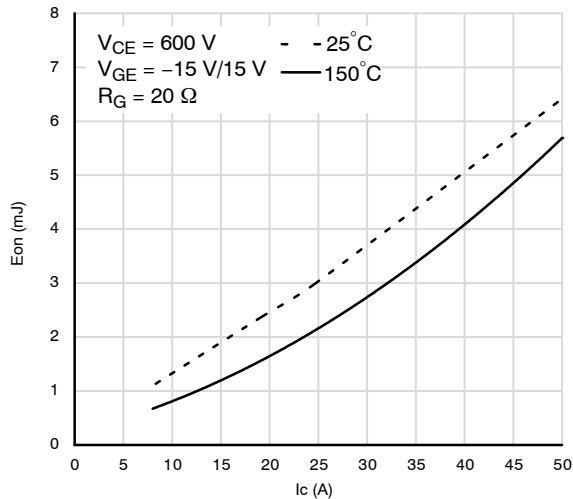

Figure 6. Inverter IGBT Typical Turn On Loss vs Ic

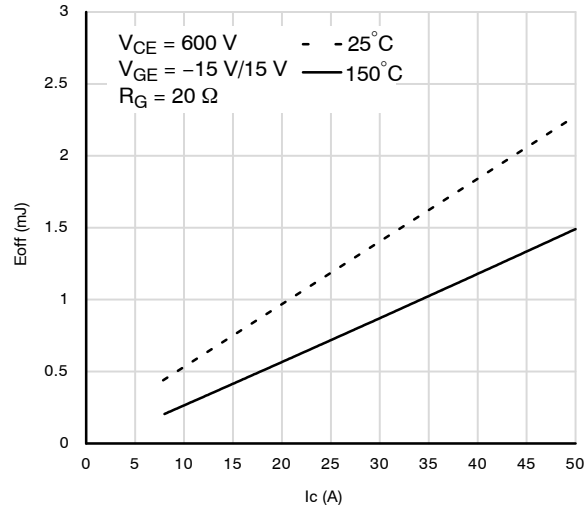

Figure 7. Inverter IGBT Typical Turn Off Loss vs Ic

TYPICAL CHARACTERISTICS – INVERTER/BRAKE IGBT & DIODE

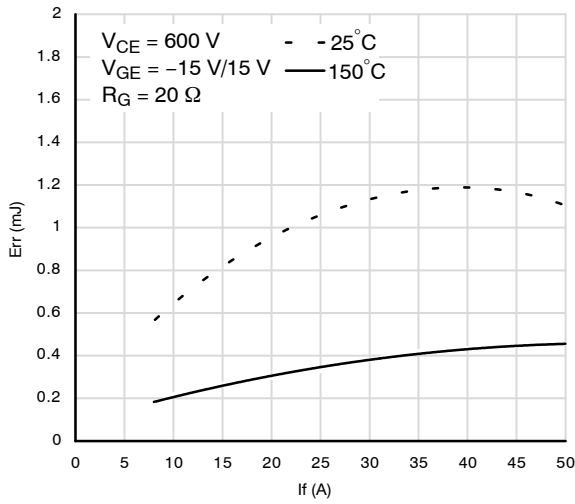

Figure 8. Inverter Diode Typical Reverse Recovery Energy vs IC

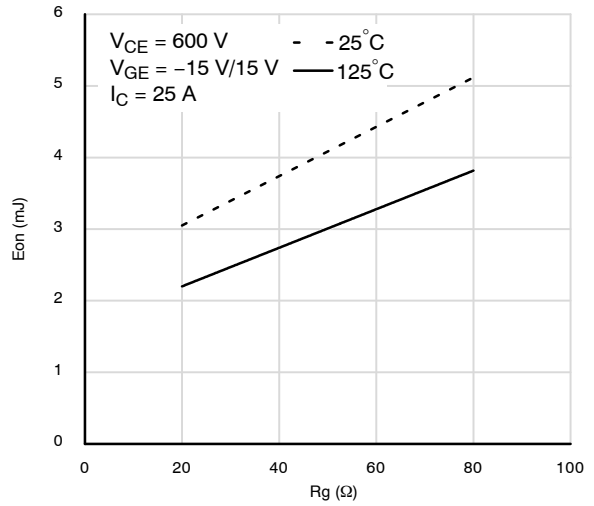

Figure 9. Inverter IGBT Typical Turn On Loss vs RG

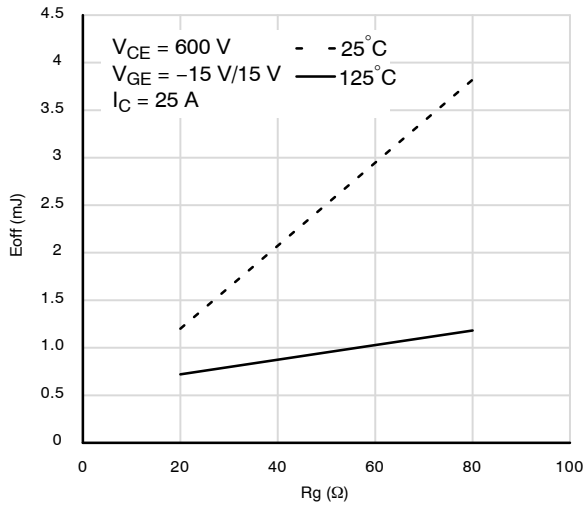

Figure 10. Inverter IGBT Typical Turn Off Loss vs RG

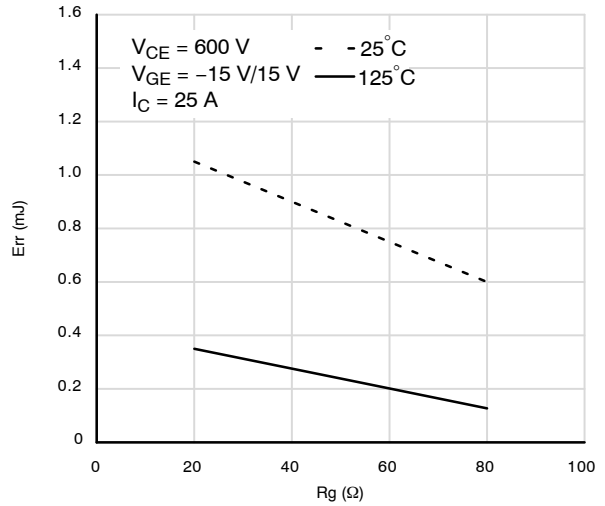

Figure 11. Inverter Diode Typical Reverse Recovery Energy vs RG

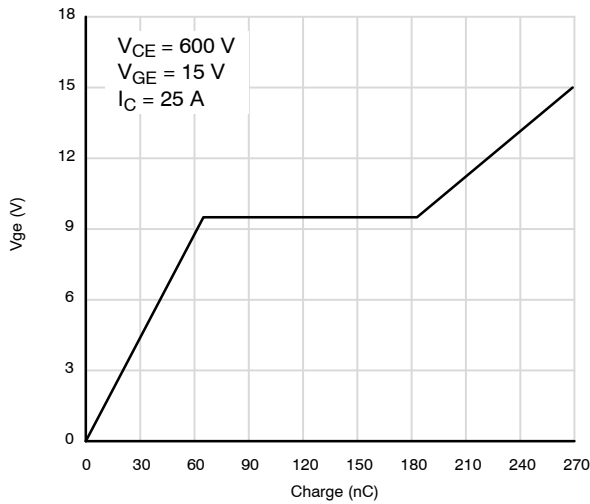

Figure 12. Inverter IGBT Gate Voltage vs Gate Charge

# NXH25C120L2C2SG

## TYPICAL CHARACTERISTICS – INVERTER/BRAKE IGBT & DIODE

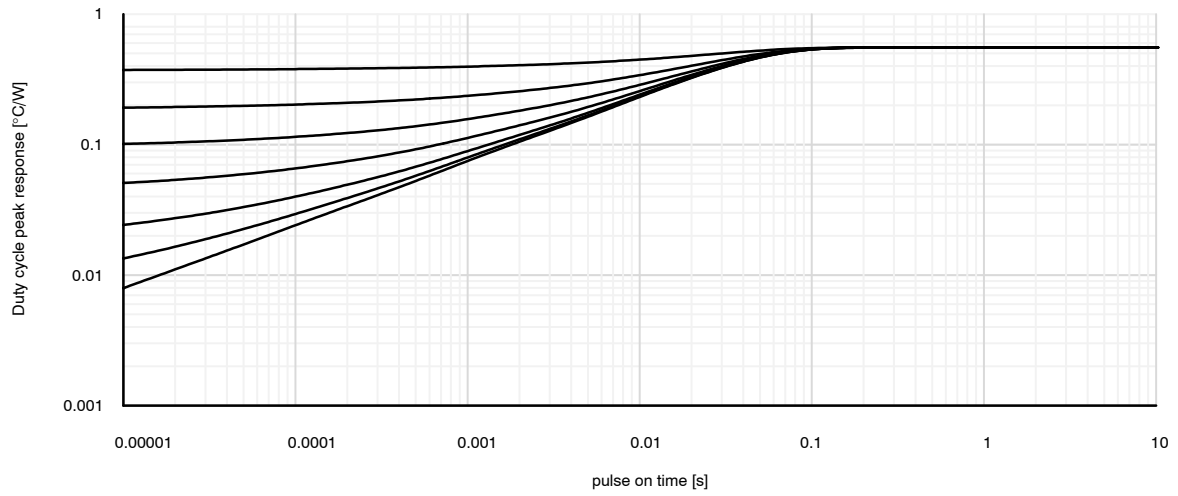

Figure 13. IGBT Junction-to-Case Transient Thermal Impedance

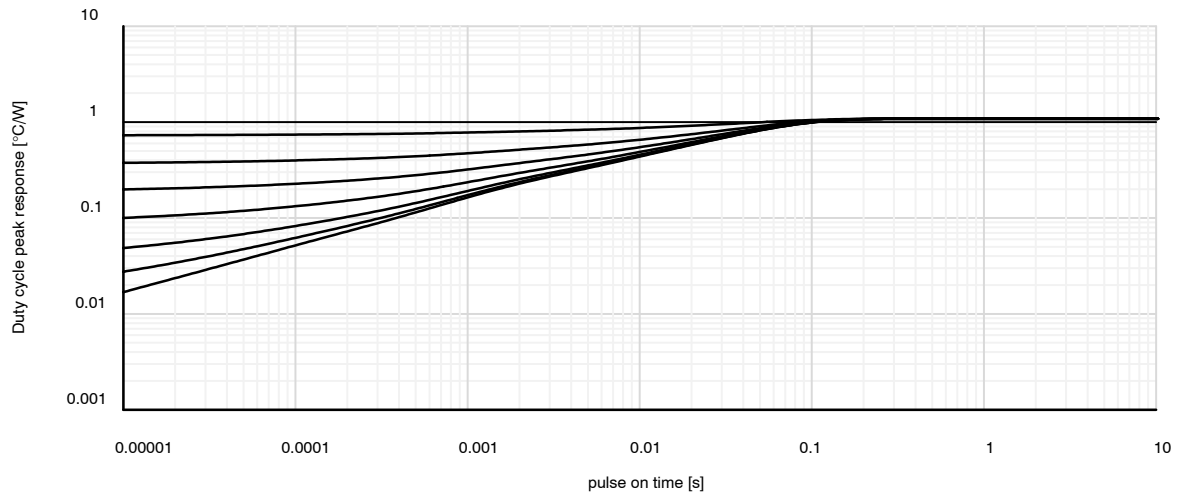

Figure 14. Diode Junction-to-Case Transient Thermal Impedance

# NXH25C120L2C2SG

## TYPICAL CHARACTERISTICS – RECTIFIER

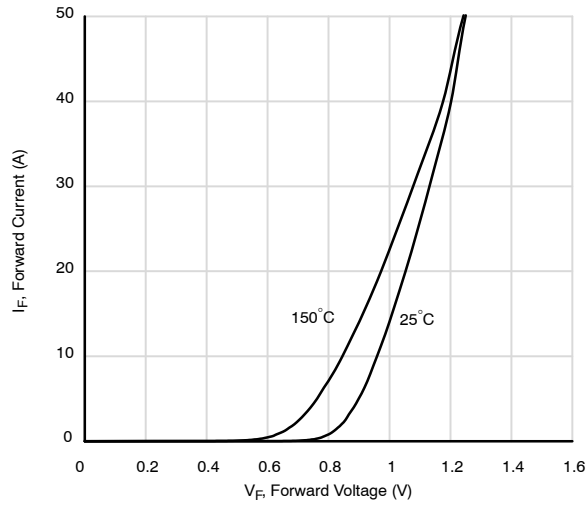

Figure 15. Rectifier Typical Forward Characteristic

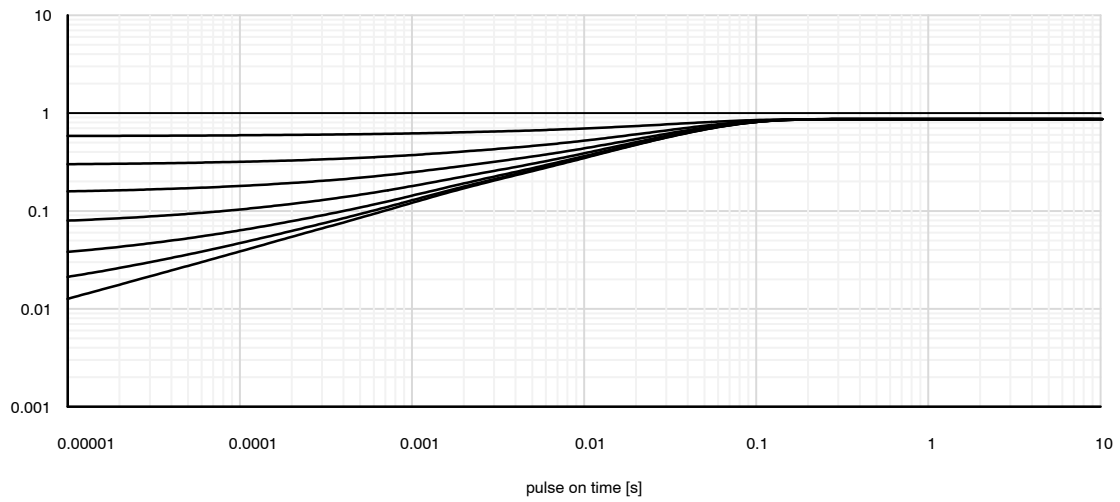
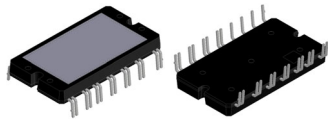

Figure 16. Rectifier Junction-to-Case Transient Thermal Impedance



# MECHANICAL CASE OUTLINE PACKAGE DIMENSIONS

ON Semiconductor®



**DIP26 67.8x40**  
**CASE 181AD**  
**ISSUE B**

DATE 05 AUG 2021

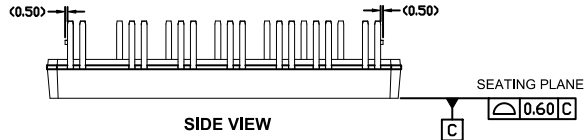

**NOTES:**

1. Dimensioning and tolerancing as per ASME Y14.5M, 2009
2. Controlling Dimension: Millimeters
3. Dimensions are exclusive of Burrs, Mold Flash, and Tiebar extrusions
4. Dimensions "b" and "c" apply to plated leads
5. Position of the leads is determine at the root of the lead where it exits the package body

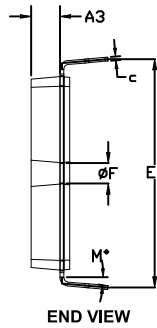
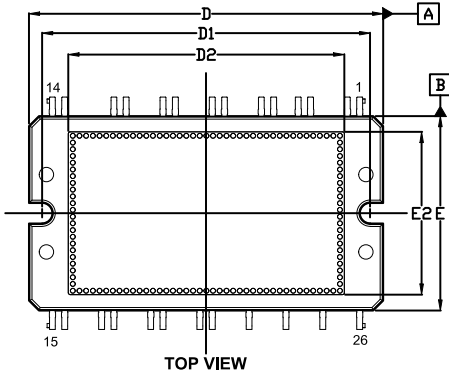

DIM	MILLIMETERS		
	MIN	NOM	MAX
A	15.50	16.00	16.50
A2	7.80	8.00	8.20
A3	6.00 REF		
b	1.10	1.20	1.30
c	0.70	0.80	0.90
D	72.70	73.20	73.70
D1	67.30	67.80	68.30
D2	57.30 REF		
E	39.70	40.20	40.70
E1	46.70	47.20	47.70
E2	33.87 REF		
e	2.54 BSC		
F	4.00	4.20	4.40
L	8.00 REF		
L1	3.50	4.00	4.50
M	4°	5°	6°

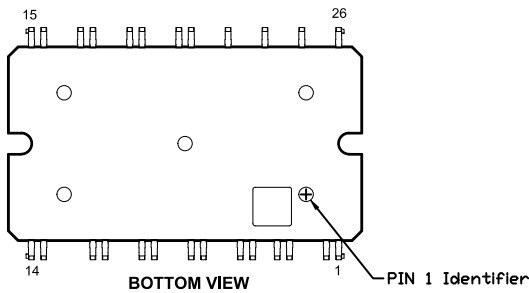
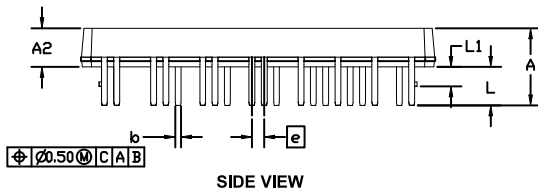

**GENERIC MARKING DIAGRAM\***

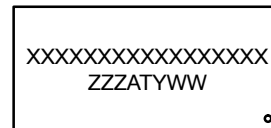

XXX = Specific Device Code  
ZZZ = Assembly Lot Code  
AT = Assembly & Test Location  
Y = Year  
WW = Work Week

\*This information is generic. Please refer to device data sheet for actual part marking. Pb-Free indicator, "G" or microdot "▪", may or may not be present. Some products may not follow the Generic Marking.

<b>DOCUMENT NUMBER:</b>	<b>98AON09519H</b>	Electronic versions are uncontrolled except when accessed directly from the Document Repository. Printed versions are uncontrolled except when stamped "CONTROLLED COPY" in red.
<b>DESCRIPTION:</b>	<b>DIP26 67.8x40</b>	<b>PAGE 1 OF 1</b>

ON Semiconductor and ON are trademarks of Semiconductor Components Industries, LLC dba ON Semiconductor or its subsidiaries in the United States and/or other countries. ON Semiconductor reserves the right to make changes without further notice to any products herein. ON Semiconductor makes no warranty, representation or guarantee regarding the suitability of its products for any particular purpose, nor does ON Semiconductor assume any liability arising out of the application or use of any product or circuit, and specifically disclaims any and all liability, including without limitation special, consequential or incidental damages. ON Semiconductor does not convey any license under its patent rights nor the rights of others.

**onsemi**, **Onsemi**, and other names, marks, and brands are registered and/or common law trademarks of Semiconductor Components Industries, LLC dba "**onsemi**" or its affiliates and/or subsidiaries in the United States and/or other countries. **onsemi** owns the rights to a number of patents, trademarks, copyrights, trade secrets, and other intellectual property. A listing of **onsemi**'s product/patent coverage may be accessed at [www.onsemi.com/site/pdf/Patent-Marking.pdf](http://www.onsemi.com/site/pdf/Patent-Marking.pdf). **onsemi** reserves the right to make changes at any time to any products or information herein, without notice. The information herein is provided "as-is" and **onsemi** makes no warranty, representation or guarantee regarding the accuracy of the information, product features, availability, functionality, or suitability of its products for any particular purpose, nor does **onsemi** assume any liability arising out of the application or use of any product or circuit, and specifically disclaims any and all liability, including without limitation special, consequential or incidental damages. Buyer is responsible for its products and applications using **onsemi** products, including compliance with all laws, regulations and safety requirements or standards, regardless of any support or applications information provided by **onsemi**. "Typical" parameters which may be provided in **onsemi** data sheets and/or specifications can and do vary in different applications and actual performance may vary over time. All operating parameters, including "Typicals" must be validated for each customer application by customer's technical experts. **onsemi** does not convey any license under any of its intellectual property rights nor the rights of others. **onsemi** products are not designed, intended, or authorized for use as a critical component in life support systems or any FDA Class 3 medical devices or medical devices with a same or similar classification in a foreign jurisdiction or any devices intended for implantation in the human body. Should Buyer purchase or use **onsemi** products for any such unintended or unauthorized application, Buyer shall indemnify and hold **onsemi** and its officers, employees, subsidiaries, affiliates, and distributors harmless against all claims, costs, damages, and expenses, and reasonable attorney fees arising out of, directly or indirectly, any claim of personal injury or death associated with such unintended or unauthorized use, even if such claim alleges that **onsemi** was negligent regarding the design or manufacture of the part. **onsemi** is an Equal Opportunity/Affirmative Action Employer. This literature is subject to all applicable copyright laws and is not for resale in any manner.

## PUBLICATION ORDERING INFORMATION

### LITERATURE FULFILLMENT:

Email Requests to: [orderlit@onsemi.com](mailto:orderlit@onsemi.com)

**onsemi Website:** [www.onsemi.com](http://www.onsemi.com)

### TECHNICAL SUPPORT

**North American Technical Support:**

Voice Mail: 1 800-282-9855 Toll Free USA/Canada

Phone: 011 421 33 790 2910

**Europe, Middle East and Africa Technical Support:**

Phone: 00421 33 790 2910

For additional information, please contact your local Sales Representative