



The Future of Analog IC Technology®

MPQ8626

16V, 6A, High Efficiency, Synchronous,
Step-Down Converter with
Adjustable Current Limit

DESCRIPTION

The MPQ8626 is a fully integrated, high-frequency, synchronous, buck converter. The MPQ8626 offers a very compact solution that achieves up to 6A of output current with excellent load and line regulation over a wide input supply range. The MPQ8626 operates at high efficiency over a wide output current load range.

The MPQ8626 adopts an internally compensated constant-on-time (COT) control that provides fast transient response and eases loop stabilization.

The operating frequency can be set to 600kHz, 1100kHz, or 2000kHz easily with MODE configuration, allowing the MPQ8626 frequency to remain constant regardless of the input and output voltages.

The output voltage start-up ramp is controlled by an internal 1.5ms timer, which can be increased by adding a capacitor on TRK/REF. An open-drain power good (PGOOD) signal indicates if the output is within its nominal voltage range. PGOOD is clamped at around 0.7V with an external pull-up voltage when the input supply fails to power the MPQ8626.

Full protection features include over-current protection (OCP), over-voltage protection (OVP), under-voltage protection (UVP), and over-temperature protection (OTP).

The MPQ8626 requires a minimal number of readily available, standard, external components and is available in a QFN-14 (2mmx3mm) package.

FEATURES

- Wide Input Voltage Range
 - 2.85V to 16V with External 3.3V VCC Bias
 - 4V to 16V with Internal VCC Bias or External 3.3V VCC Bias
- 6A Output Current
- Programmable Accurate Current Limit Level
- Low $R_{DS(ON)}$ Integrated Power MOSFETs

- Proprietary Switching Loss Reduction Technique
- Adaptive Constant-On-Time (COT) for Ultrafast Transient Response
- Stable with Zero ESR Output Capacitor
- 0.5% Reference Voltage Over 0°C to +70°C Junction Temperature Range
- 1% Reference Voltage Over -40°C to +125°C Junction Temperature Range
- Selectable Forced CCM or Pulse-Skip Operation
- Excellent Load Regulation
- Output Voltage Tracking
- Output Voltage Discharge
- PGOOD Active Clamped at Low Level during Power Failure
- Programmable Soft-Start Time from 1ms and Up
- Pre-Bias Start-Up
- Selectable Switching Frequency from 600kHz, 1100kHz, and 2000kHz
- Non-Latch for OCP, OVP, UVP, OTP, and UVLO
- Output Adjustable from 0.6V to 0.9 x VIN Up to 6V Max
- Available in a QFN-14 (2mmx3mm) Package

APPLICATIONS

- Telecom and Networking Systems
- Server, Cloud-Computing, Storage
- Base Stations
- General Purpose Point-of-Load (PoL)
- 12V Distribution Power Systems
- High-end TV
- Game Consoles and Graphic Cards

All MPS parts are lead-free, halogen-free, and adhere to the RoHS directive. For MPS green status, please visit the MPS website under Quality Assurance. "MPS" and "The Future of Analog IC Technology" are registered trademarks of Monolithic Power Systems, Inc.

TYPICAL APPLICATION CIRCUIT

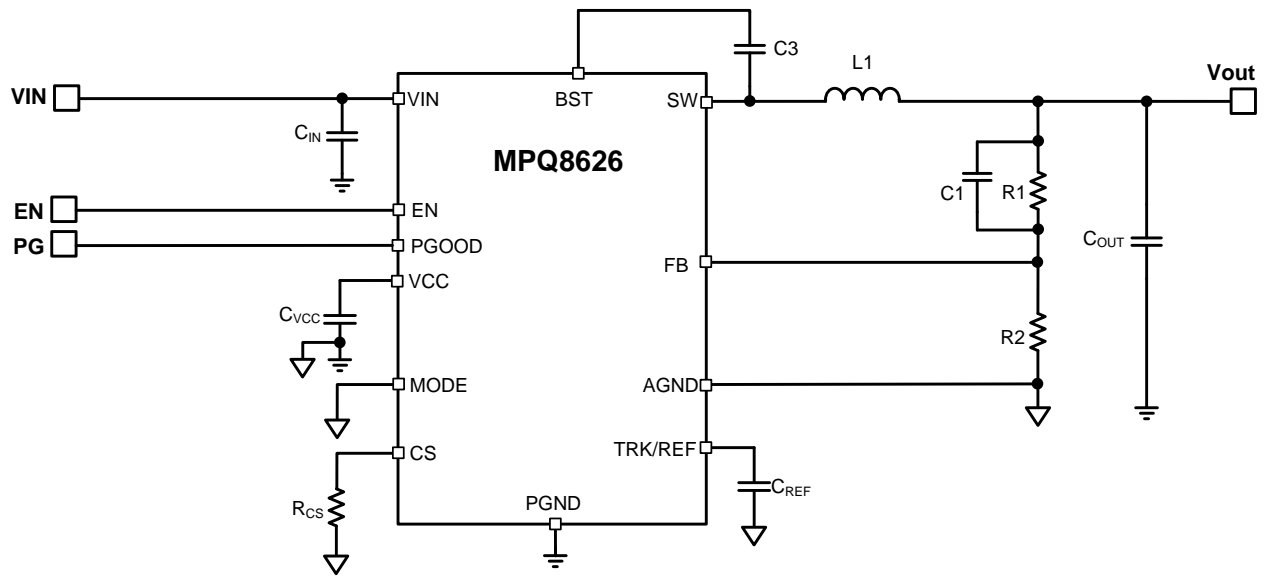

ORDERING INFORMATION

Part Number*	Package	Top Marking	MSL
MPQ8626GD	QFN-14 (2mmx3mm)	<i>See Below</i>	1

* For Tape & Reel, add suffix -Z (e.g. MPQ8626GD-Z)

TOP MARKING

—
AWR

YWW

LLL

AWR: Product code of MPQ8626GD
 Y: Year code
 WW: Week code
 LLL: Lot number

PACKAGE REFERENCE

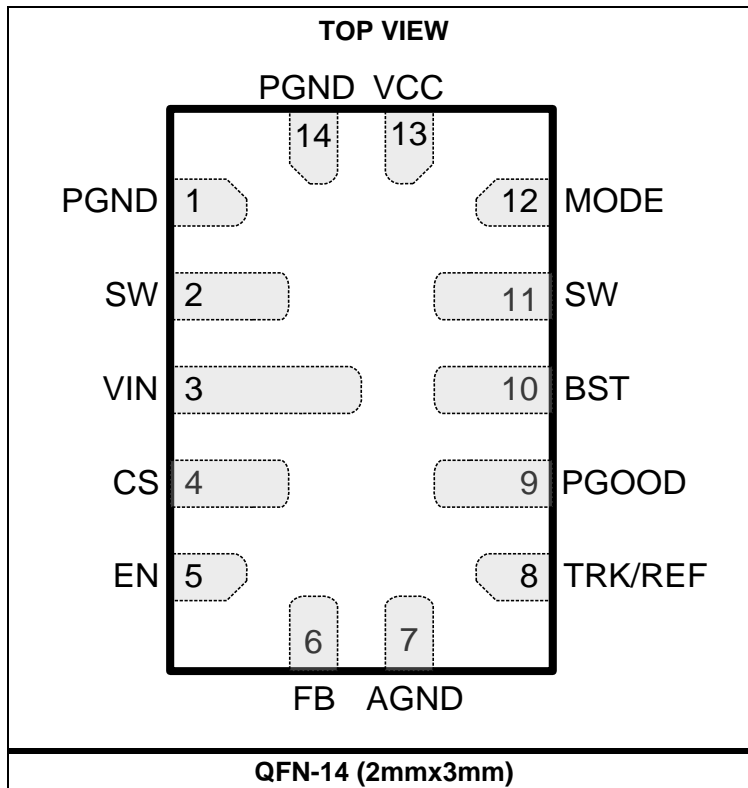

ABSOLUTE MAXIMUM RATINGS (1)

Supply voltage (VIN).....	18V
V _{SW} (DC)	-0.3V to VIN + 0.3V
V _{SW} (25ns) (2)	-3V to 25V
V _{SW} (25ns).....	-5V to 25V
V _{BST}	V _{SW} + 4V
VCC, EN	-0.3V to 4.5V
All other pins	-0.3V to 4.3V
Junction temperature	170°C
Lead temperature	260°C
Storage temperature.....	-65°C to +170°C

Recommended Operating Conditions (3)

Supply voltage (VIN).....	4V to 16V
V _{IN(DC)} - V _{SW(DC)} (4)	-0.3V to VIN + 0.3V
V _{SW(DC)} (5)	-0.3V to VIN + 0.3V
Output voltage (V _{OUT})	0.6V to 6V
External VCC bias (V _{CC_EXT}).....	3.12V to 3.6V
Maximum output current (I _{OUT_MAX}).....	6A
Maximum output current limit (I _{OC_MAX}).....	8A
Maximum peak inductor current (I _{L_PEAK})	10A
EN voltage (V _{EN})	3.6V
Operating junction temp. (T _J)... ..	-40°C to +125°C

Thermal Resistance (6) θ_{JB} θ_{JC_TOP}	
QNF-14 (2mmx3mm).....	6.8 17.4... °C/W

NOTES:

- 1) Exceeding these ratings may damage the device.
- 2) Measured by using a differential oscilloscope probe.
- 3) The device is not guaranteed to function outside of its operating conditions.
- 4) The voltage rating can be in the range of -5V to 24V for a period of 25ns or less with a maximum repetition rate of 2MHz when the input voltage is 16V.
- 5) The voltage rating can be in the range of -3V to 24V for a period of 25ns or less with a maximum repetition rate of 2MHz when the input voltage is 16V.
- 6) θ_{JB} is the thermal resistance from the junction to the board around the PGND soldering point.
 θ_{JC_TOP} is the thermal resistance from the junction to the top of the package.

ELECTRICAL CHARACTERISTICS

$V_{IN} = 12V$, $T_J = -40^{\circ}C$ to $125^{\circ}C$, unless otherwise noted.

Parameters	Symbol	Condition	Min	Typ	Max	Units
V_{IN} Supply Current						
Supply current (shutdown)	I_{IN}	$V_{EN} = 0V$		0	10	μA
Supply current (quiescent)	I_{IN}	$V_{EN} = 2V$, $V_{FB} = 0.7V$		650	850	μA
MOSFET						
Switch leakage	SW_{LKG_HS}	$V_{EN} = 0V$, $V_{SW} = 0V$		0	10	μA
	SW_{LKG_LS}	$V_{EN} = 0V$, $V_{SW} = 12V$		0	30	
HS on-state resistance	$R_{DS_ON_HS}$	$V_{EN} = 2V$ @ $25^{\circ}C$		22.6		$m\Omega$
LS on-state resistance	$R_{DS_ON_HS}$	$V_{EN} = 2V$ @ $25^{\circ}C$		8.1		$m\Omega$
Current Limit						
Current limit threshold	V_{LIM}		1.15	1.2	1.25	V
I_{CS} to I_{OUT} ratio	I_{CS}/I_{OUT}	$I_{OUT} \geq 2A$	36	40	44	$\mu A/A$
Low-side negative current limit	$I_{LIM_NEG_10}$			-8		A
Negative current limit time-out ⁽⁷⁾	t_{NCL_Timer}			80		ns
Timer						
Switching frequency ⁽⁸⁾	f_{sw}		530	660	790	kHz
			935	1100	1265	
			1870	2200	2530	
Minimum on time ⁽⁷⁾	T_{ON_MIN}			50		ns
Minimum off time ⁽⁷⁾	T_{OFF_MIN}	$V_{FB} = 1000mV$			180	ns
Over-Voltage (OVP) and Under-Voltage Protection (UVP)						
OVP threshold	V_{OVP}		113%	116%	119%	V_{REF}
UVP threshold	V_{UVP}		77%	80%	83%	V_{REF}
Feedback Voltage and Soft Start (SS)						
Feedback voltage	V_{REF}	$T_J = -40^{\circ}C$ to $+125^{\circ}C$	594	600	606	mV
		$T_J = 0^{\circ}C$ to $+70^{\circ}C$	597	600	603	
TRK/REF sourcing current	I_{TRACK_Source}	$V_{TRK/REF} = 0V$		15		μA
TRK/REF sinking current	I_{TRACK_Sink}	$V_{TRK/REF} = 0.7V$		6		μA
Soft-start time	t_{SS}	$C_{TRACK} = 1nF$	1.6	2.2		ms
Error Amplifier (EA)						
Error amplifier offset	V_{OS}		-3	0	3	mV
Feedback current	I_{FB}	$V_{FB} = REF$		50	100	nA
Enable (EN)						
Enable input rising threshold	V_{IHEN}		1.17	1.22	1.27	V
Enable hysteresis	V_{EN-HYS}			200		mV
Enable input current	I_{EN}	$V_{EN} = 2V$		0		μA
Soft shutdown discharge MOSFET	R_{ON_DISCH}			80		Ω
V_{IN} UVLO						
V_{IN} under-voltage lockout threshold rising	$V_{IN}V_{th-Rise}$	$V_{CC} = 3.3V$	2.25	2.55	2.85	V
V_{IN} under-voltage lockout threshold falling	$V_{IN}V_{th-Fall}$		1.7	2	2.3	V
VCC Regulator						
VCC under-voltage lockout threshold rising	$V_{CC}V_{th_Rise}$		2.65	2.8	2.95	V
VCC under-voltage lockout threshold falling	$V_{CC}V_{th_Fall}$		2.35	2.5	2.65	V
VCC output voltage	V_{CC}		2.88	3.00	3.12	V
VCC load regulation		$I_{CC} = 25mA$		0.5		%

ELECTRICAL CHARACTERISTICS *(continued)*

$V_{IN} = 12V$, $T_J = -40^{\circ}C$ to $+125^{\circ}C$, unless otherwise noted.

Parameters	Symbol	Condition	Min	Typ	Max	Units
Power Good (PGOOD)						
Power good high threshold	$PG_{Vth_Hi_Rise}$	FB from low to high	89.5%	92.5%	95.5%	V_{REF}
Power good low threshold	$PG_{Vth_Lo_Rise}$	FB from low to high	113%	116%	119%	V_{REF}
	$PG_{Vth_Lo_Fall}$	FB from high to low	77%	80%	83%	V_{REF}
Power good low-to-high delay	PG_{Td}	$T_J = 25^{\circ}C$	0.7	1	1.3	ms
Power good sink current capability	V_{PG}	$I_{PG} = 10mA$			0.4	V
Power good leakage current	I_{PG_LEAK}	$V_{PG} = 3V$			3	μA
Power good low-level output voltage	V_{OL_100}	$V_{IN} = 0V$, pull PGOOD up to 3.3V through a 100k Ω resistor		650	850	mV
	V_{OL_10}	$V_{IN} = 0V$, pull PGOOD up to 3.3V through a 10k Ω resistor		800	1000	
Thermal Protection (OTP)						
OTP shutdown ⁽⁷⁾	T_{SD}		150	160		$^{\circ}C$
OTP shutdown hysteresis ⁽⁷⁾	T_{SD_Hys}			20		$^{\circ}C$

NOTES:

- 7) Specified by design and characterization, not tested in production.
- 8) Specified by design.

TYPICAL PERFORMANCE CHARACTERISTICS

$V_{IN} = 12V$, $V_{OUT} = 1.8V$, $L = 1\mu H$, $T_A = +25^\circ C$, unless otherwise noted.

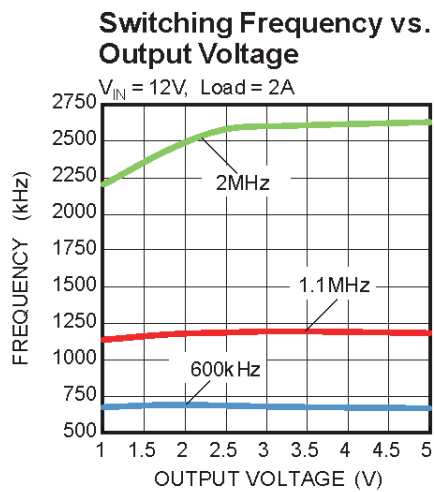
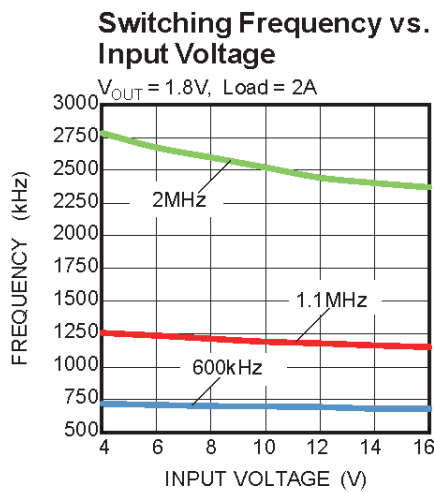
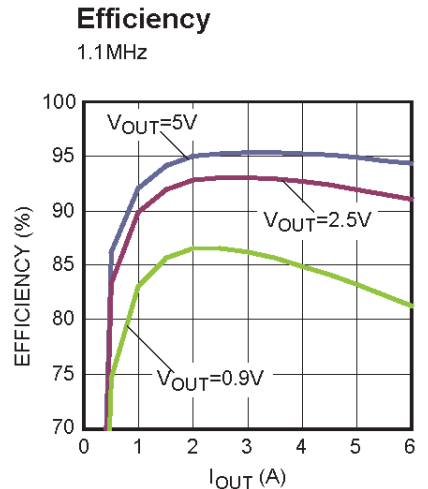
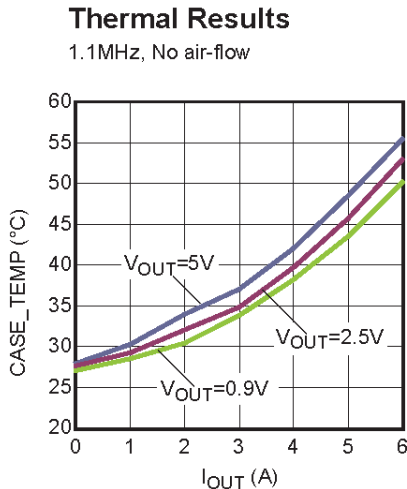
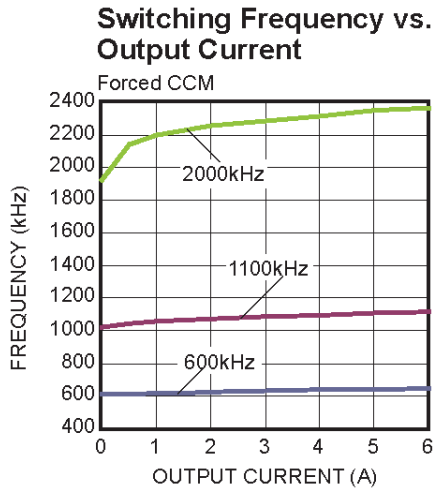
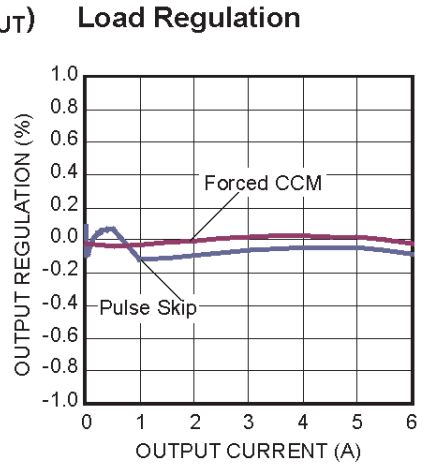
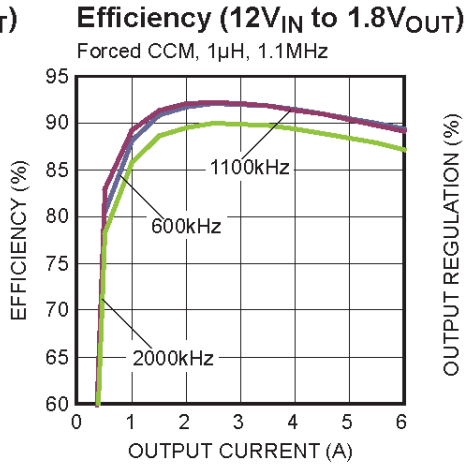
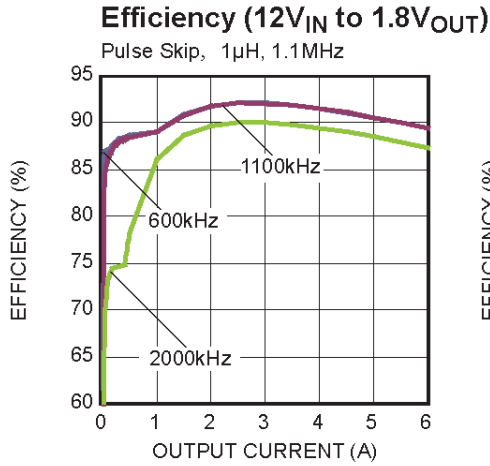

TYPICAL PERFORMANCE CHARACTERISTICS (continued)

$V_{IN} = 12V$, $V_{OUT} = 1.8V$, $L = 1\mu H$, $T_A = +25^\circ C$, unless otherwise noted.

Steady State
 $I_{OUT} = 0A$, Pulse Skip

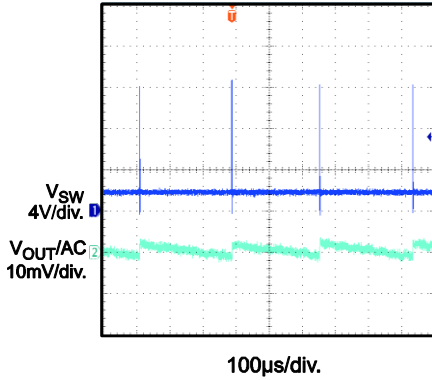

Steady State
 $I_{OUT} = 0.5A$, Pulse Skip

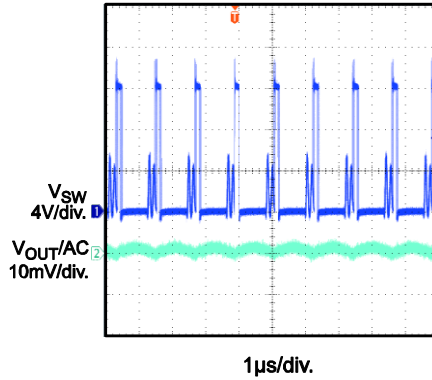

Steady State
 $I_{OUT} = 6A$, Pulse Skip

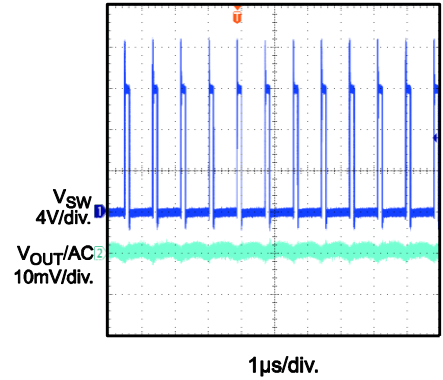

Steady State
 $I_{OUT} = 0A$, Forced CCM

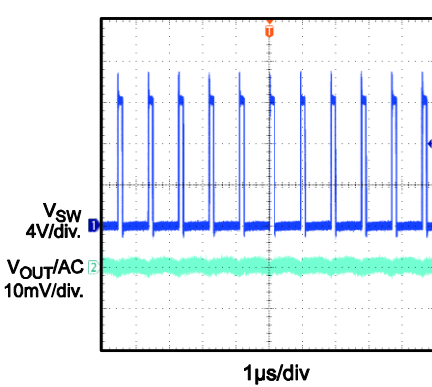

Steady State
 $I_{OUT} = 6A$, Forced CCM

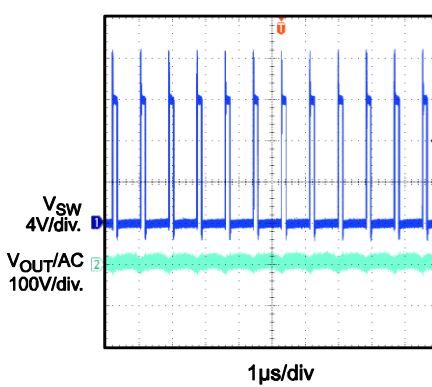

Load Transient
 $I_{OUT} = 0A-3A$, Pulse Skip

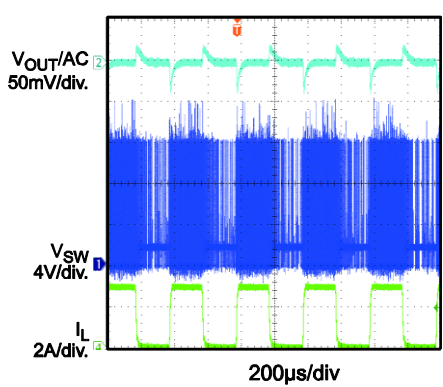

Load Transient
 $I_{OUT} = 0A-3A$, Forced CCM

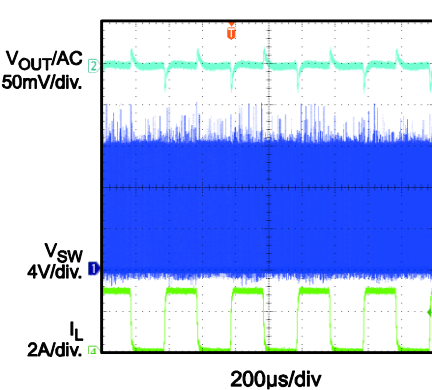

Power-Up through EN
 $I_{OUT} = 0A$, Pulse Skip

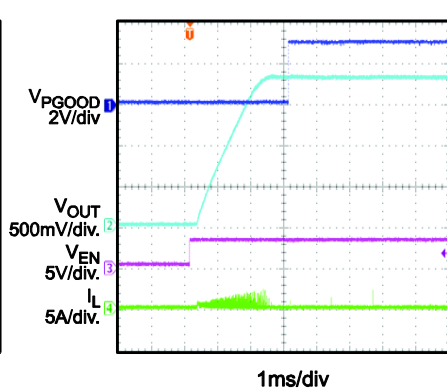

Power-Up through EN
 $I_{OUT} = 6A$, Pulse Skip

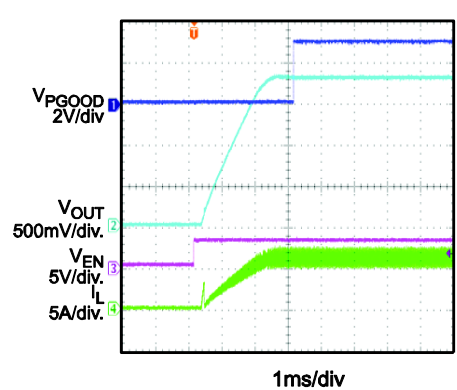

TYPICAL PERFORMANCE CHARACTERISTICS (continued)

$V_{IN} = 12V$, $V_{OUT} = 1.8V$, $L = 1\mu H$, $T_A = +25^\circ C$, unless otherwise noted.

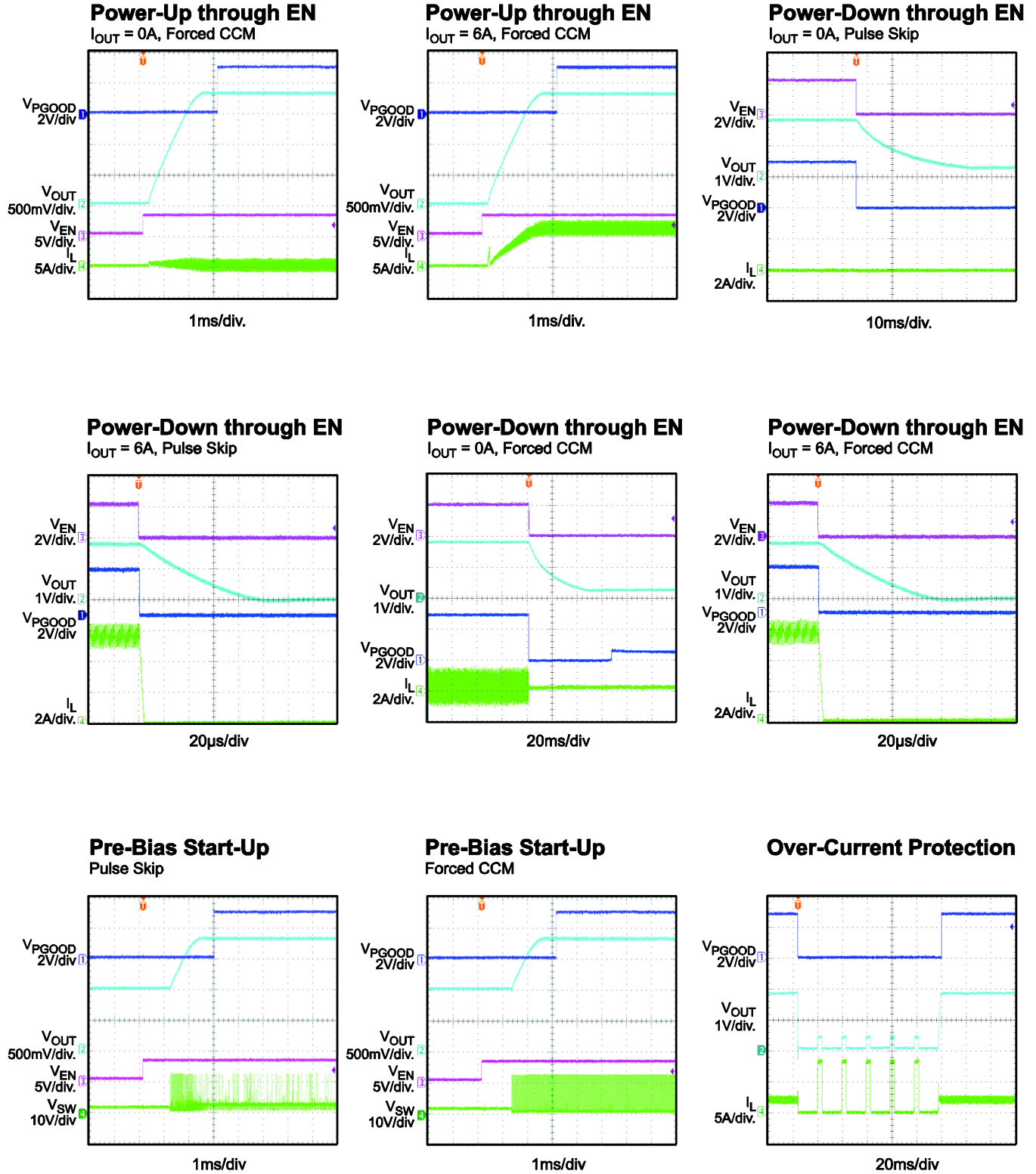

TYPICAL PERFORMANCE CHARACTERISTICS *(continued)*

$V_{IN} = 12V$, $V_{OUT} = 1.8V$, $L = 1\mu H$, $T_A = +25^\circ C$, unless otherwise noted.

OSM Operation Pulse Skip Mode

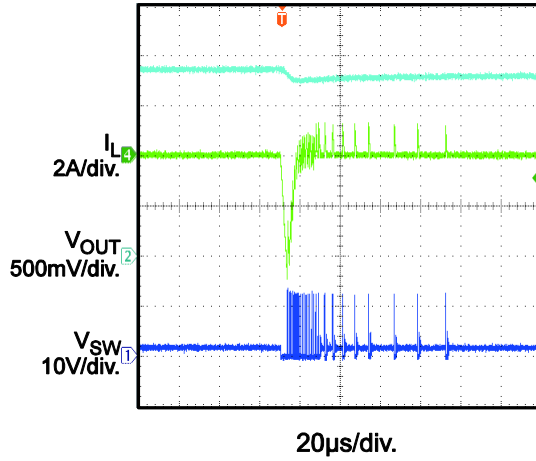

Over-Voltage Protection

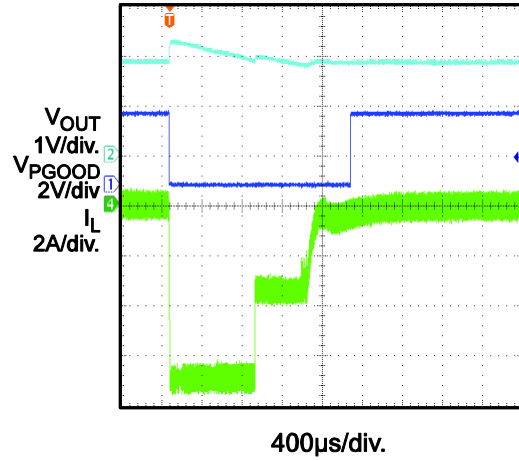

PIN FUNCTIONS

PIN #	Name	Description
1, 14	PGND	System ground. PGND is the reference ground of the regulated output voltage. PGND requires careful consideration during PCB layout. Connect PGND using wide PCB traces.
2, 11	SW	Switch output. Connect SW to the inductor and bootstrap capacitor. SW is driven up to VIN by the high-side switch during the on-time of the PWM duty cycle. The inductor current drives SW low during the off-time. Connect SW using wide PCB traces.
3	VIN	Input voltage. VIN supplies power to the internal MOSFET and regulator. Input capacitors are needed to decouple the input rail. Connect VIN using wide PCB traces.
4	CS	Current limit. Connect a resistor from CS to ground to set the current limit trip point. See Table 2 for additional details.
5	EN	Enable. EN is an input signal that turns the regulator on or off. Drive EN high to turn on the regulator; drive EN low to turn off the regulator. Connect EN to VIN through a pull-up resistor or a resistive voltage divider for automatic start-up. Do not float EN.
6	FB	Feedback. An external resistor divider from the output to AGND tapped to FB sets the output voltage. It is recommended to place the resistor divider as close to FB as possible. Vias should be avoided on the FB traces.
7	AGND	Analog ground. Select AGND as the control circuit reference point.
8	TRK/REF	External tracking voltage input. The output voltage tracks this input signal. Decouple TRK/REF with a ceramic capacitor placed as close to it as possible. Ceramic capacitors with X7R or X5R grade dielectrics are recommended for their stable temperature characteristics. The capacitance of this capacitor determines the soft-start time. See Equation 2 and 3 for additional details.
9	PGOOD	Power good output. PGOOD is an open-drain signal. A pull-up resistor connected to a DC voltage is required to indicate a logic high signal if the output voltage is within regulation. There is a delay of about 1ms from the time FB is greater than or equal to 92.5% and PGOOD pulling high.
10	BST	Bootstrap. Connect a capacitor between SW and BS to form a floating supply across the high-side switch driver.
12	MODE	Operation mode selection. Program MODE to select CCM, pulse-skip mode, or the operating switching frequency. See Table 1 for additional details.
13	VCC	Internal 3V LDO output. The driver and control circuits are powered from VCC. Decouple VCC with a minimum 1µF ceramic capacitor as close to it as possible. Ceramic capacitors with X7R or X5R grade dielectrics are recommended for their stable temperature characteristics.

BLOCK DIAGRAM

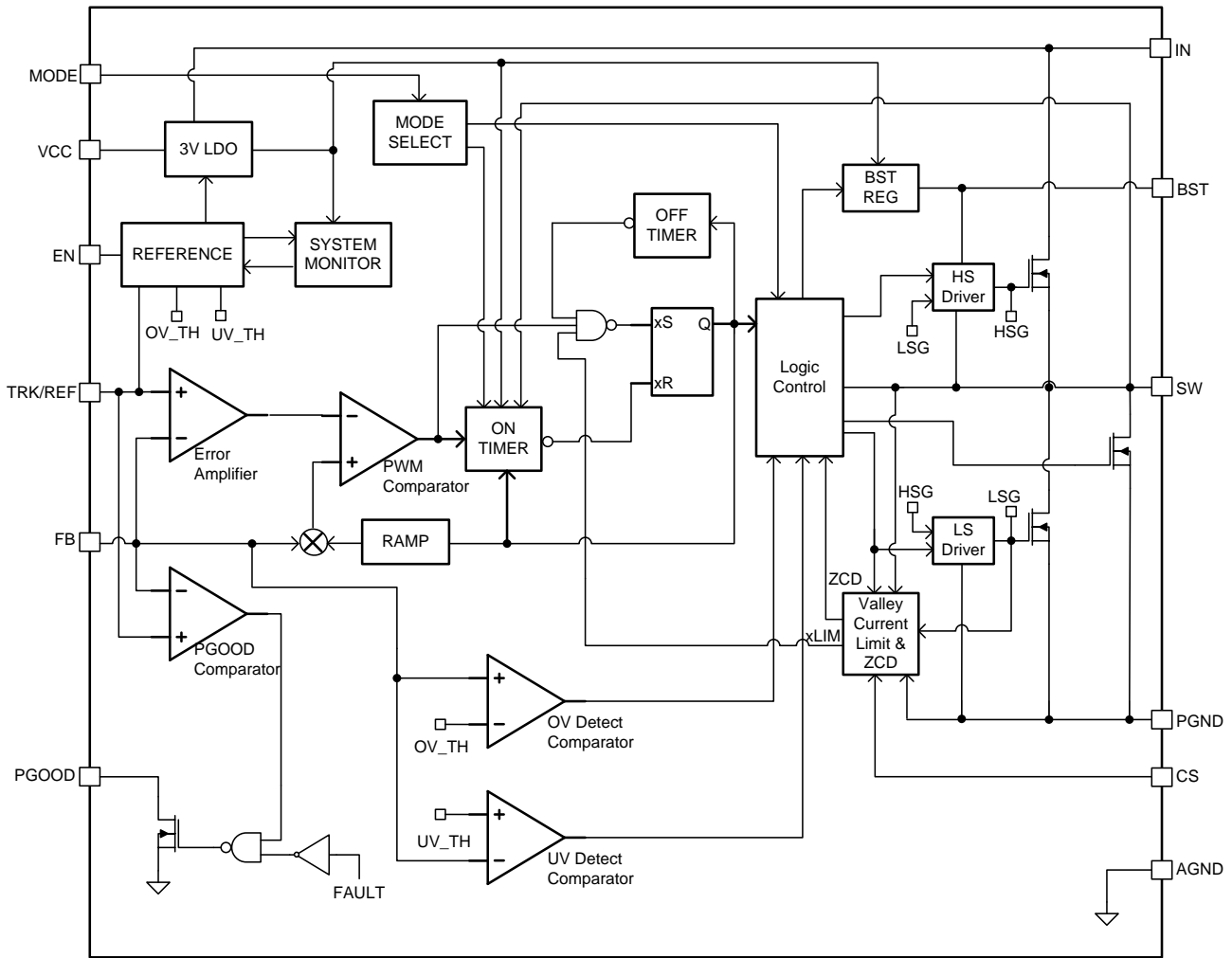

Figure 1: Functional Block Diagram

OPERATION

Constant-On-Time (COT) Control

The MPQ8626 employs constant-on-time (COT) control to achieve fast load transient response. Figure 2 shows the details of the control stage of the MPQ8626.

The operational amplifier (AMP) corrects any error voltage between FB and REF. The MPQ8626 can use AMP to provide excellent load regulation over the entire load range, whether it is operating in forced continuous conduction mode (CCM) or pulse-skip mode.

The MPQ8626 has internal ramp compensation to support low ESR MLCC output capacitor solutions. The adaptive internal ramp is optimized so that the MPQ8626 is stable in the entire operating input/output voltage range with a proper design of the output L/C filter.

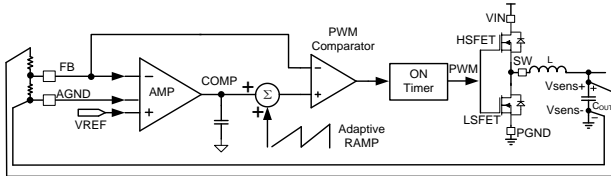

Figure 2: COT Control

Pulse-Width Modulation (PWM) Operation

Figure 3 shows how the pulse-width modulation (PWM) signal is generated. AMP corrects any error between FB and REF and generates a fairly smooth DC voltage (COMP). The internal ramp is superimposed onto COMP. The superimposed COMP is compared with the FB signal. Whenever FB drops below the superimposed COMP, the integrated high-side MOSFET (HS-FET) is turned on and remains on for a fixed turn-on time. The fixed on time is determined by the input voltage, output voltage, and selected switching frequency. After the on period elapses, the HS-FET turns off. The HS-FET turns on again when FB drops below the superimposed COMP. By repeating this operation, the MPQ8626 regulates the output voltage. The integrated low-side MOSFET (LS-FET) turns on when the HS-FET is in its off state to minimize conduction loss.

A dead short occurs between VIN and PGND if both the HS-FET and the LS-FET are turned on at the same time. This is called a shoot-through. To avoid shoot-through, a dead time (DT) is generated internally between the HS-FET off and the LS-FET on period or the LS-FET off and the HS-FET on period.

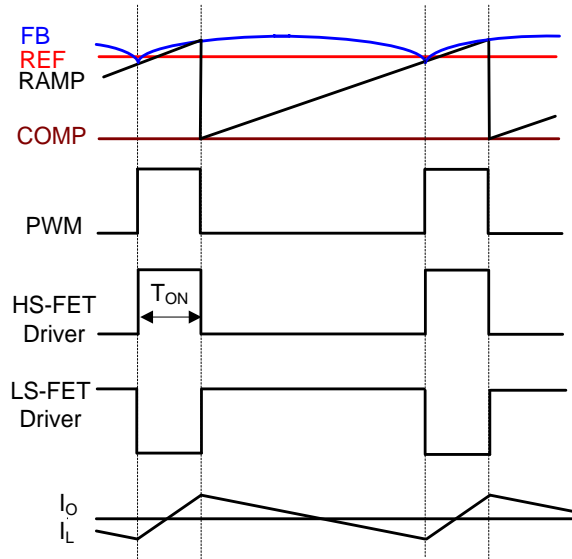

Figure 3: Heavy-Load Operation (PWM)

Continuous Conduction Mode (CCM) Operation

Continuous conduction mode (CCM) occurs when the output current is high and the inductor current is always above zero amps (see Figure 3). The MPQ8626 can also be configured to operate in forced CCM operation when the output current is low. See the MODE Selection section on page 14 for details.

In CCM operation, the switching frequency is fairly constant (PWM mode), so the output ripple remains almost constant throughout the entire load range.

Pulse-Skip Operation (PSM)

At light-load condition, the MPQ8626 can be configured to work in pulse-skip mode (PSM) to optimize efficiency. When the load decreases, the inductor current decreases as well. Once the inductor current reaches zero, the MPQ8626 transitions from CCM to PSM if the MPQ8626 is configured in this way. See the MODE Selection section on page 14 for details.

Figure 4 shows PSM operation at light-load condition. When FB drops below the superimposed COMP, the HS-FET turns on for a fixed interval. When the HS-FET turns off, the LS-FET turns on until the inductor current reaches zero. In PSM operation, FB does not reach the superimposed COMP when the inductor current approaches zero. The LS-FET driver turns into tri-state (Hi-Z) when the inductor current reaches zero. A current modulator takes over the control of the LS-FET and limits the inductor current to less than -1mA. Therefore, the output capacitors discharge slowly to PGND through the LS-FET. In light-load condition, the HS-FET is not turned on as frequently in PSM as it is in forced CCM. As a result, the efficiency in PSM is improved greatly compared to that in forced CCM operation.

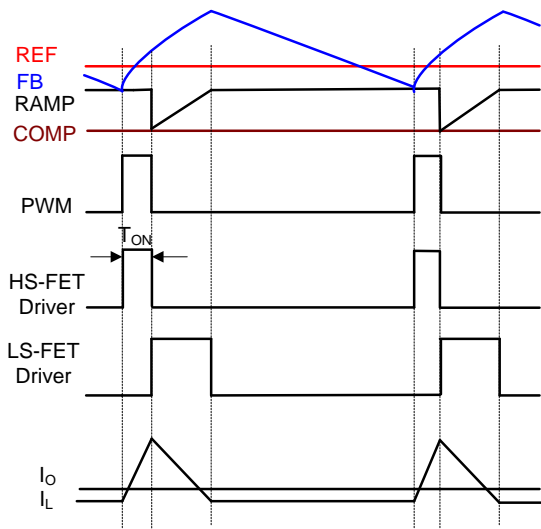

Figure 4: Pulse Skip in Light Load

As the output current increases from light-load condition, the current modulator regulation time period becomes shorter. The HS-FET is turned on more frequently, and the switching frequency increases accordingly. The output current reaches critical levels when the current modulator time is zero. The critical level of the output current can be determined with Equation (1):

$$I_{OUT} = \frac{(V_{IN} - V_{OUT}) \times V_{OUT}}{2 \times L \times F_{SW} \times V_{IN}} \quad (1)$$

Where F_{SW} is the switching frequency.

The MPQ8626 enters PWM mode once the output current exceeds the critical level. Afterward, the switching frequency remains fairly constant over the output current range.

The MPQ8626 can be configured to operate in forced CCM, even in light-load condition (see Table 1).

MODE Selection

The MPQ8626 provides both forced CCM operation and pulse-skip operation in light-load condition. The MPQ8626 has three options for switching frequency: 600kHz, 1100kHz, and 2000kHz. Selecting the operation mode under light-load condition and the switching frequency is done by choosing the resistance value of the resistor connected between MODE and AGND or VCC (see Table 1).

Table 1: MODE Selection

MODE	Light-Load Mode	Switching Frequency
AGND	Forced CCM	1100kHz
30.1kΩ (±20%) to AGND	Forced CCM	2000kHz
60.4kΩ (±20%) to AGND	Forced CCM	600kHz
121kΩ (±20%) to AGND	Pulse skip	600kHz
243kΩ (±20%) to AGND	Pulse skip	2000kHz
VCC	Pulse skip	1100kHz

Soft Start (SS)

The minimum soft-start time is limited to 2.2ms. This can be increased by choosing the capacitance between TRK/REF and AGND. A minimum value of 3.3nF for this capacitor is always required to stabilize the reference voltage.

The capacitance of this capacitor can be determined with Equation (2) and Equation (3):

$$C_{REF} (nF) = 3.3 \sim 33 \quad (t_{SS} = 2.2ms) \quad (2)$$

$$C_{REF} (nF) = \frac{t_{SS} (ms) \times 10\mu A}{0.6V} \quad (t_{SS} > 2.2ms) \quad (3)$$

Output Voltage Tracking and Reference

The MPQ8626 provides an analog input pin (TRK/REF) to track another power supply or accept an external reference voltage (V_{REF}). When an external voltage signal is connected to TRK/REF, it acts as a reference for the MPQ8626 output voltage. The FB voltage (V_{FB}) follows this external voltage signal exactly, and the soft-start settings are ignored. The TRK/REF input signal can be in the range of 0.3V to 1.4V. During the initial start-up, the TRK/REF must reach 600mV or above first to ensure proper operation. Afterward, TRK/REF can be set to any value between 0.3V and 1.4V.

Pre-Bias Start-Up

The MPQ8626 has been designed for monotonic start-up into pre-biased loads. If the output is pre-biased to a certain voltage during start-up, the IC disables switching for both the HS-FET and LS-FET until the voltage on the TRK/REF capacitor exceeds the sensed output V_{FB} . Before the TRK/REF voltage reaches the pre-biased FB level, if the BST voltage (from BST to SW) is lower than 2.3V, the LS-FET is turned on to allow the BST voltage to be charged through VCC. The LS-FET is turned on for very narrow pulses, so the drop in the pre-biased level is negligible.

Output Voltage Discharge

When the MPQ8626 is disabled through EN, the output voltage discharge mode is enabled. This causes both the HS-FET and the LS-FET to latch off. A discharge MOSFET connected between SW and PGND is turned on to discharge the output voltage. The typical switch on resistance of this MOSFET is about 80Ω. Once V_{FB} drops below 20% * REF, the discharge MOSFET turns off.

Current Sense and Over-Current Protection (OCP)

The MPQ8626 features an on-die current sense and a programmable positive current limit threshold. The current limit is active when the MPQ8626 is enabled. During the LS-FET on state, the SW current (inductor current) is sensed and mirrored to CS with the ratio of G_{CS} . By using a resistor (R_{CS}) from CS to AGND, the CS voltage (V_{CS}) is proportional to the SW current cycle-by-cycle. The HS-FET is only allowed to turn on when V_{CS} is below the

internal over-current protection (OCP) voltage threshold (V_{OCP}) during the LS-FET on state to limit the SW valley current cycle-by-cycle.

Generally, the current limit threshold setting is calculated from R_{CS} with Equation (4):

$$R_{CS}(\Omega) = \frac{V_{OCP}}{G_{CS} \times (I_{LIM} - \frac{(V_{IN} - V_O) \times V_O}{V_{IN}} \times \frac{1}{2 \times L \times f_s})} \tag{4}$$

Where V_{OCP} is 1.2V, G_{CS} is 40μA/A, and I_{LIM} is the desired output current limit.

There is some offset for the low current limit threshold setting. Refer to Table 2 for a more accurate setting.

Table 2: Threshold Setting

L_{LIM_DC} (A)	R_{CS} (KΩ)
8	3.83
7.5	4.02
7	4.32
6.5	4.64
6	4.87
5.5	5.49
5	5.9
4.5	6.49
4	7.15

The OCP HICCUP is active 3ms after the MPQ8626 is enabled, Once OCP HICCUP is active, if the MPQ8626 detects over-current condition for consecutive 31 cycles, or if the FB drops below under-voltage protection (UVP) threshold, it enters HICCUP mode. In HICCUP mode, the MPQ8626 latches off the HSFET immediately, and latches off LSFET after ZCD is detected. Meanwhile, the TRK/REF capacitor is also discharged. After about 14ms, the MPQ8626 will try to soft start automatically. If the over-current condition still holds after 3ms of running, the MPQ8626 repeats this operation cycle until the over-current condition disappears, and the output voltage rises smoothly back to the regulation level.

Negative Inductor Current Limit

When the LS-FET detects a -8A current, the MPQ8626 turns off the LS-FET and turns on the HS-FET for 100ns to limit the negative current.

Output Sinking Mode (OSM)

The MPQ8626 employs output sinking mode (OSM) to regulate the output voltage to the

targeted value. When V_{FB} is higher than $105\% \cdot V_{REF}$ but below the over-voltage protection (OVP) threshold, OSM is triggered. During OSM, the LS-FET remains on until it reaches the -4A negative current limit. The LS-FET is then turned off, the HS-FET is turned on momentarily for 100ns, and then the LS-FET is turned on again. The MPQ8626 repeats this operation until V_{FB} drops below $102\% \cdot V_{REF}$. The MPQ8626 exits OSM after 15 consecutive cycles of forced CCM.

Over-Voltage Protection (OVP)

The MPQ8626 monitors the output voltage by connecting FB to the tap of the output voltage feedback resistor divider to detect an over-voltage condition. This provides hiccup OVP.

If V_{FB} exceeds 116% of V_{REF} , OVP is triggered. PG is pulled low until the over-voltage (OV) condition is cleared. The LS-FET is turned on until it reaches the low-side negative current limit of -8A (NOCP). The LS-FET is then turned off momentarily for 100ns, and the HS-FET is turned on. After 100ns, the LS-FET is turned on again. The MPQ8626 continues this operation to discharge the over-voltage condition on the output. The device exits OVP discharge mode when V_{FB} drops below $105\% \cdot V_{REF}$. PGOOD is pulled high again a 1ms delay.

Over-Temperature Protection (OTP)

The MPQ8626 has over-temperature protection (OTP). The MPQ8626 monitors the junction temperature internally. If the junction temperature exceeds the threshold value (typically 160°C), the converter shuts off. There is a hysteresis of about 20°C . Once the junction temperature drops to around 140°C , a new SS is initiated.

Output Voltage Setting and Remote Output Voltage Sensing

First, choose a value for R1. Then R2 can be determined with Equation (5):

$$R_2(\text{k}\Omega) = \frac{V_{REF}}{V_O - V_{REF}} \times R_1(\text{k}\Omega) \tag{5}$$

Where V_{REF} is 600mV.

To optimize the load transient response, a feed-forward capacitor (C_{FF}) is recommended to be added in parallel to R1. R1 and C_{FF} add an

extra zero to the system, which improves loop response. R1 and C_{FF} are selected so that the zero formed by R1 and C_{FF} is located around 20 ~ 60kHz. f_z can be determined with Equation (6):

$$f_z = \frac{1}{2\pi \times R1 \times C_{FF}} \tag{6}$$

Power Good (PGOOD)

The MPQ8626 has a power good (PGOOD) output. PGOOD is the open drain of a MOSFET. Connect PGOOD to VCC or another external voltage source less than 3.6V through a pull-up resistor (typically 10k Ω). After applying the input voltage, the MOSFET turns on, so PGOOD is pulled to GND before TRK/REF is ready. After V_{FB} reaches 92.5% of V_{REF} , PGOOD is pulled high after a 0.8ms delay.

When V_{FB} drops to 80% of V_{REF} or exceeds 116% of the nominal V_{REF} , PGOOD is latched low. PGOOD can be pulled high again only after a new SS.

If the input supply fails to power the MPQ8626, PGOOD is clamped low, even though PGOOD is tied to an external DC source through a pull-up resistor. The relationship between the PGOOD voltage and the pull-up current is shown in Figure 5.

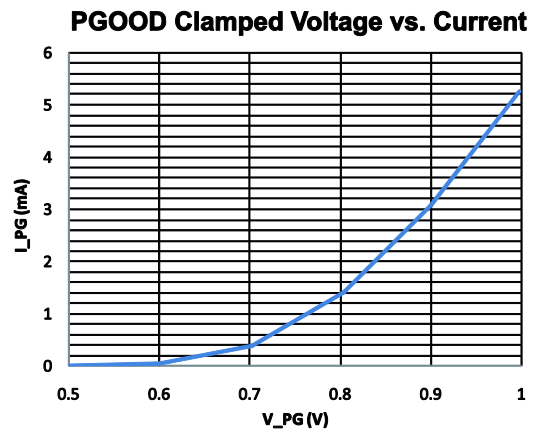

Figure 5: PGOOD Clamped Voltage vs. Pull-Up Current

Enable (EN) Configuration

The MPQ8626 turns on when EN goes high and turns off when EN goes low. EN cannot be left floating for proper operation. EN can be driven by an analog or digital control logic signal to enable or disable the MPQ8626.

The MPQ8626 provides accurate EN thresholds, so a resistor divider (R3/R4 in Figure 2) from VIN to AGND can be used to program the input voltage at which the MPQ8626 is enabled. This is highly recommended for applications where there is no dedicated EN control logic signal to avoid possible under-voltage lockout (UVLO) bouncing during power-up and power-down. The resistor divider values can be determined with Equation (7):

$$V_{IN_START} (V) = V_{IH_{EN}} \times \frac{R_{UP} + R_{DOWN}}{R_{DOWN}} \quad (7)$$

Where $V_{IH_{EN}}$ is 1.22V, typically.

R_{UP} and R_{DOWN} should be chosen so that V_{EN} does not exceed 3.6V when VIN reaches the maximum value.

EN can also be connected to VIN directly through a pull-up resistor (R_{UP}). R_{UP} should be chosen so that the maximum current going to EN is 50 μ A. R_{UP} can be calculated with Equation (8):

$$R_{UP} (k\Omega) = \frac{V_{IN_{MAX}} (V)}{0.05(mA)} \quad (8)$$

APPLICATION INFORMATION

Input Capacitor

The input current to the step-down converter is discontinuous and therefore requires a capacitor to supply AC current to the step-down converter while maintaining the DC input voltage. Use ceramic capacitors for the best performance. During layout, place the input capacitors as close to VIN as possible.

The capacitance can vary significantly with the temperature. Capacitors with X5R and X7R ceramic dielectrics are recommended because they are fairly stable over a wide temperature range. The capacitors must have a ripple current rating that exceeds the converter's maximum input ripple current. Estimate the input ripple current with Equation (9):

$$I_{CIN} = I_{OUT} \times \sqrt{\frac{V_{OUT}}{V_{IN}} \times \left(1 - \frac{V_{OUT}}{V_{IN}}\right)} \quad (9)$$

The worst-case condition occurs at $V_{IN} = 2V_{OUT}$, shown in Equation (10):

$$I_{CIN} = \frac{I_{OUT}}{2} \quad (10)$$

For simplification, choose an input capacitor with an RMS current rating that exceeds half the maximum load current.

The input capacitance value determines the converter input voltage ripple. Select a capacitor value that meets any input voltage ripple requirement.

Estimate the input voltage ripple with Equation (11):

$$\Delta V_{IN} = \frac{I_{OUT}}{F_{SW} \times C_{IN}} \times \frac{V_{OUT}}{V_{IN}} \times \left(1 - \frac{V_{OUT}}{V_{IN}}\right) \quad (11)$$

The worst-case condition occurs at $V_{IN} = 2V_{OUT}$, shown in Equation (12):

$$\Delta V_{IN} = \frac{1}{4} \times \frac{I_{OUT}}{F_{SW} \times C_{IN}} \quad (12)$$

Output Capacitor

The output capacitor maintains the DC output voltage. Use ceramic capacitors or POSCAPs. Estimate the output voltage ripple with Equation (13):

$$\Delta V_{OUT} = \frac{V_{OUT}}{F_{SW} \times L} \times \left(1 - \frac{V_{OUT}}{V_{IN}}\right) \times \left(R_{ESR} + \frac{1}{8 \times F_{SW} \times C_{OUT}}\right) \quad (13)$$

When using ceramic capacitors, the capacitance dominates the impedance at the switching frequency. The capacitance also dominates the output voltage ripple. For simplification, estimate the output voltage ripple with Equation (14):

$$\Delta V_{OUT} = \frac{V_{OUT}}{8 \times F_{SW}^2 \times L \times C_{OUT}} \times \left(1 - \frac{V_{OUT}}{V_{IN}}\right) \quad (14)$$

The ESR dominates the switching frequency impedance for POSCAPs. For simplification, the output ripple can be approximated with Equation (15):

$$\Delta V_{OUT} = \frac{V_{OUT}}{F_{SW} \times L} \times \left(1 - \frac{V_{OUT}}{V_{IN}}\right) \times R_{ESR} \quad (15)$$

Inductor

The inductor supplies a constant current to the output load while being driven by the switching input voltage. A larger value inductor results in less ripple current and lower output ripple voltage, but also has a larger physical size, a higher series resistance, and a lower saturation current. Generally, select an inductor value that allows the inductor peak-to-peak ripple current to be 30% to 40% of the maximum switch current limit. Also design for a peak inductor current that is below the maximum switch current limit. Calculate the inductance value with Equation (16):

$$L = \frac{V_{OUT}}{F_{SW} \times \Delta I_L} \times \left(1 - \frac{V_{OUT}}{V_{IN}}\right) \quad (16)$$

Where ΔI_L is the peak-to-peak inductor ripple current.

Choose an inductor that will not saturate under the maximum inductor peak current. The peak inductor current can be calculated with Equation (17):

$$I_{LP} = I_{OUT} + \frac{V_{OUT}}{2 \times F_{SW} \times L} \times \left(1 - \frac{V_{OUT}}{V_{IN}}\right) \quad (17)$$

PCB Layout Guidelines

Efficient PCB layout is critical for stable operation. For the best performance, refer to Figure 6 and follow the guidelines below.

1. Place the input MLCC capacitors as close to VIN and PGND as possible.
2. Place the major MLCC capacitors on the same layer as the MPQ8626.
3. Maximize the VIN and PGND copper plane to minimize parasitic impedance.
4. Place as many PGND vias as possible as close to PGND as possible to minimize both parasitic impedance and thermal resistance.
5. Place the VCC decoupling capacitor close to the device.
6. Connect AGND and PGND at the point of the VCC capacitor's ground connection.
7. Place the BST capacitor as close to BST and SW as possible.
8. Use traces with a width of 20mil or wider to route the path.
9. Use a 0.1μF to 1μF bootstrap capacitor.
10. Place the REF capacitor close to TRK/REF to AGND.

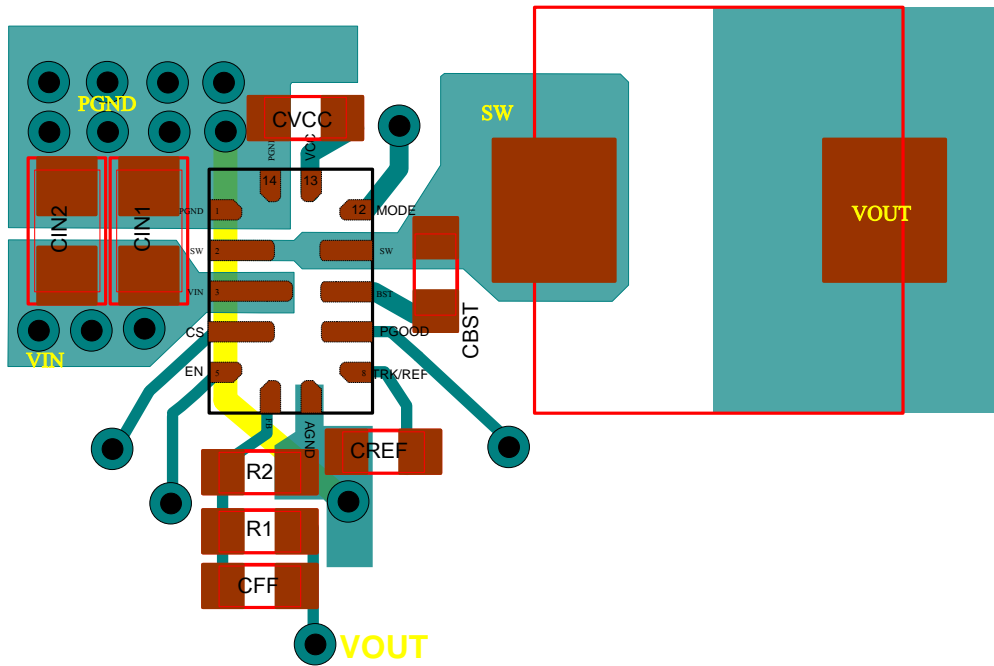

Figure 6: Example of PCB Layout (Placement & Top Layer PCB)

NOTE: Via size is 20/10mils.

REFLOW TEMPERATURE PROFILE

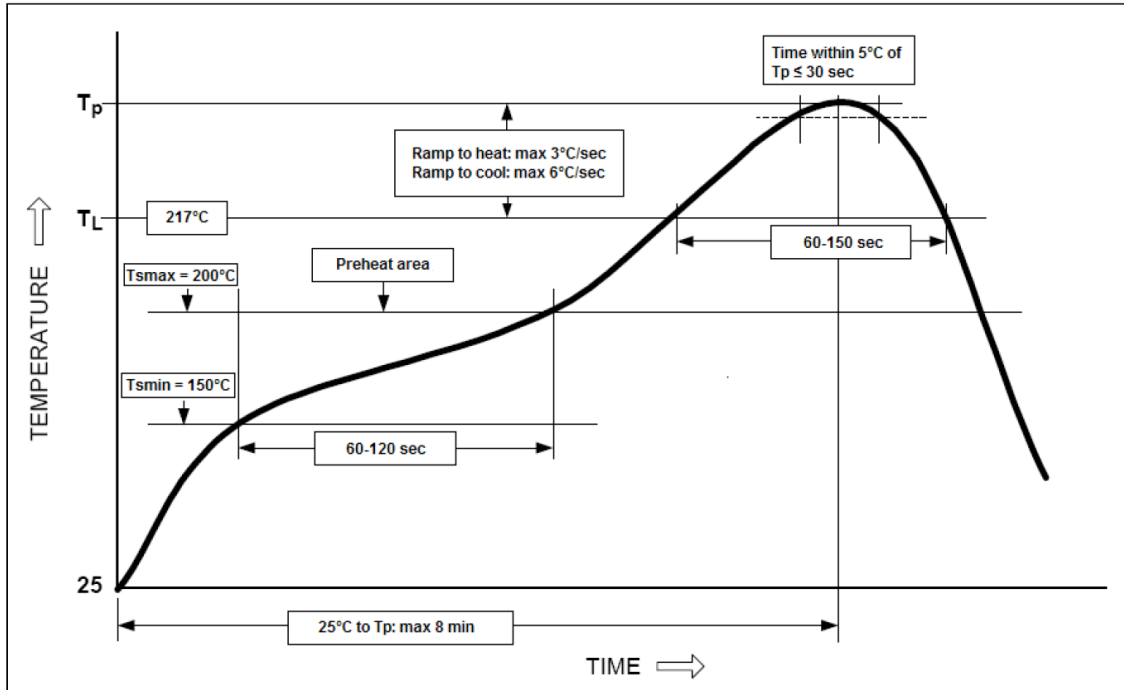
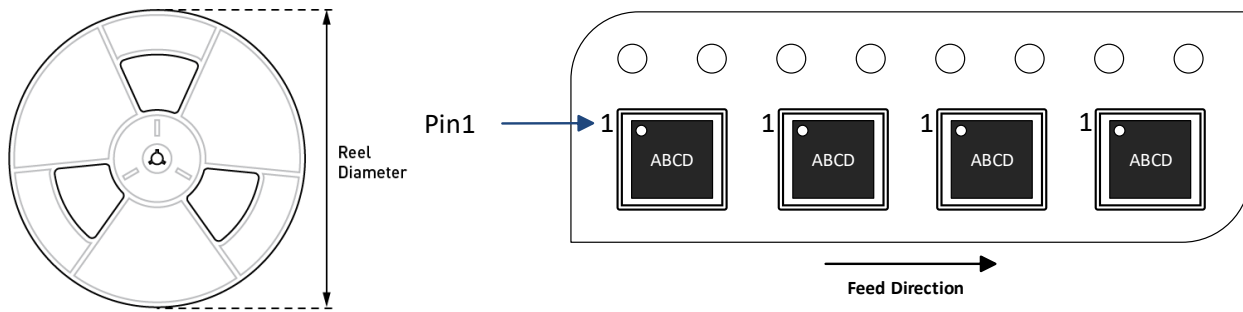

Figure 7: Reflow Temperature Profile

Table 3: T_P for Pb-Free Process

Package Thickness	Volume (mm^3) < 350	Volume (mm^3) 350 to 2000	Volume (mm^3) > 2000
<1.6mm	$\leq 260^\circ\text{C}$	$\leq 260^\circ\text{C}$	$\leq 260^\circ\text{C}$
1.6mm to 2.5mm	$\leq 260^\circ\text{C}$	$\leq 250^\circ\text{C}$	$\leq 245^\circ\text{C}$
>2.5mm	$\leq 250^\circ\text{C}$	$\leq 245^\circ\text{C}$	$\leq 245^\circ\text{C}$

CARRIER INFORMATION



Part Number	Package Description	Quantity/ Reel	Quantity/ Tube	Quantity/ Tray	Reel Diameter	Carrier Tape Width	Carrier Tape Pitch
MPQ8626GD	QFN-14 (2mmx3mm)	5000	N/A	N/A	13in	12mm	8mm

REVISION HISTORY

Revision #	Revision Date	Description	Pages Updated
1.0	5/31/2017	Initial Release	-
1.01	8/24/2018	Update the applications, TPC1 condition	P7
		Update HS, LS on resistance (EC table)	P5
1.02	12/12/2018	Update SS time (EC table)	P5
		Add two curves (F_{SW} vs V_{IN} , F_{SW} vs V_{OUT})	P7
1.1	8/16/2022	Added MSL information	3
		Updated Switching Frequency vs. Output Voltage curve X-axis label	7
		Updated time in Soft Start (SS)	14
		Updated Output Voltage Discharging description (10% to 20%)	15
		Added Reflow Temperature Profile information	20
		Renumbered Figure 7 to Figure 6	
Added Carrier Information	22		

NOTICE: The information in this document is subject to change without notice. Please contact MPS for current specifications. Users should warrant and guarantee that third party Intellectual Property rights are not infringed upon when integrating MPS products into any application. MPS will not assume any legal responsibility for any said applications.