

## Slew Rate Controlled Load Switch

### FEATURES

- 1.8 V to 5.5 V Input Voltage range
- Very Low  $R_{DS(ON)}$ , typically 80 m $\Omega$  (5 V)
- Slew rate limited turn-on time options
  - SiP4280-1: 1 ms
  - SiP4280-3: 100  $\mu$ s
- Fast shutdown load discharge option
- Low quiescent current
- 4 kV ESD Rating
- 6 pin SOT23 package

### DESCRIPTION

The SiP4280 is a P-Channel MOSFET power switch designed for high-side load switching applications. The output pass transistor is a P-Channel MOSFET transistor with typically 80 m $\Omega$   $R_{DS(ON)}$ . The SiP4280 is available in two different versions of turn-on times. The SiP4280-1 version has a slew rate limited turn-on time typically of 1 ms. The SiP4280-3 version has a slew rate limited turn-on time typically of 100  $\mu$ s and additionally offers a shutdown load discharge circuit to rapidly turn off a load circuit when the switch is disabled.

Both SiP4280 load switch versions operate with an

### APPLICATIONS

- Cellular telephones
- Digital still cameras
- Personal digital assistants (PDA)
- Hot swap supplies
- Notebook computers
- Personal communication devices



input voltage ranging from 1.8 V to 5.5 V, making them ideal for both 3 V and 5 V applications. The SiP4280 also features an under-voltage lock out which turns the switch off when an input undervoltage condition exists. Input logic levels are TTL and 2.5 V to 5.0 V CMOS compatible. The quiescent supply current is very low, typically 2.5  $\mu$ A. In shutdown mode, the supply current decreases to less than 1.0  $\mu$ A.

The SiP4280 is available in a 6 pin SOT23 package and is specified over - 40  $^{\circ}$ C to 85  $^{\circ}$ C temperature range.

### TYPICAL APPLICATION CIRCUIT

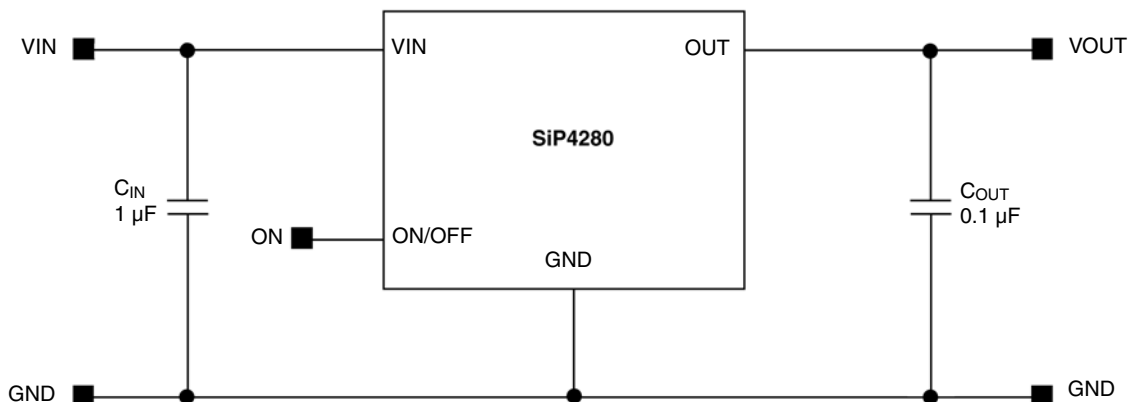

ABSOLUTE MAXIMUM RATINGS				
Parameter		Symbol	Steady State	Unit
Supply Input Voltage		$V_{IN}$	- 0.3 to 6	V
Enable Input Voltage		$V_{ON}$	- 0.3 to 6	
Output Voltage		$V_{OUT}$	- 0.3 to $V_{IN} + 0.3$	
Maximum Switch Current		$I_{MAX}$	2.3	A
Maximum Pulsed Current	$V_{IN} \geq 2.5$	$I_{DM}$	6	
	$V_{IN} < 2.5$	$I_{DM}$	3	
Junction Temperature		$T_J$	- 40 to 150	°C
Thermal Resistance	SOT23-6L	$\Phi_{JA}^a$	180	°C/W
Power Dissipation	SOT23-6L <sup>b</sup>	$P_D$	440	mW

Notes:

a. Device mounted with all leads soldered or welded to PC board.

b. Derate 5.5 mW/°C above  $T_A = 70$  °C.

Stresses beyond those listed under "Absolute Maximum Ratings" may cause permanent damage to the device. These are stress ratings only, and functional operation of the device at these or any other conditions beyond those indicated in the operational sections of the specifications is not implied. Exposure to absolute maximum rating/conditions for extended periods may affect device reliability.

RECOMMENDED OPERATING RANGE all voltages referenced to GND = 0 V				
Parameter		Symbol	Steady State	Unit
		$V_{IN}$	1.8 to 5.5	V
Operating Temperature Range			- 40 to 85	°C

SPECIFICATIONS						
Parameter	Symbol	Test Conditions Unless Specified $V_{IN} = 5$ V, $T_A = - 40$ to $+ 85$ °C	Limits			Unit
			Min <sup>a</sup>	Typ <sup>b</sup>	Max <sup>a</sup>	
<b>SiP4280 All Versions</b>						
Operating Voltage <sup>c</sup>	$V_{IN}$		1.8	-	5.5	V
Undervoltage Lockout	$V_{UVLO}$	$V_{IN}$ Falling	1.0	1.4	1.8	
Undervoltage Lockout Hysteresis	$V_{UVLO(hyh)}$		-	250	-	mV
Quiescent Current	$I_Q$	ON/OFF = active	-	2.5	4	$\mu$ A
Off Supply Current	$I_{Q(OFF)}$	ON/OFF = inactive, OUT = open	-	0.01	1	
Off Switch Current	$I_{SD(OFF)}$	ON/OFF = inactive, $V_{OUT} = 0$	-	0.01	1	
On-Resistance	$R_{DS(ON)}$	$V_{IN} = 5$ V, $T_A = 25$ °C	-	80	120	m $\Omega$
		$V_{IN} = 4.2$ V, $T_A = 25$ °C	-	85	130	
		$V_{IN} = 3$ V, $T_A = 25$ °C	-	100	150	
		$V_{IN} = 1.8$ V, $T_A = 25$ °C	-	160	250	
On-Resistance Temp-Coefficient	$TC_{RDS}$		-	2800	-	ppm/°C
ON/OFF Input Low Voltage <sup>d</sup>	$V_{IL}$	$V_{IN} = 2.7$ V to $5.5$ V	-	-	0.8	V
ON/OFF Input High Voltage	$V_{IH}$	$V_{IN} = 2.7$ V to $\leq 4.2$ V	2	-	-	
ON/OFF Input High Voltage		$V_{IN} > 4.2$ V to $5.5$ V	2.4	-	-	
ON/OFF Input Leakage	$I_{SINK}$	$V_{ON/OFF} = 5.5$ V	-	-	1	$\mu$ A
<b>SiP4280-1 Version</b>						
Output Turn-On Delay Time	$T_{D(ON)}$	$V_{IN} = 5$ V, $R_{LOAD} = 10$ $\Omega$ , $T_A = 25$ °C	-	20	40	$\mu$ S
Output Turn-On Rise Time	$T_{ON}$	$V_{IN} = 5$ V, $R_{LOAD} = 10$ $\Omega$ , $T_A = 25$ °C	-	1000	1500	
Output Turn-Off Delay Time	$T_{D(OFF)}$	$V_{IN} = 5$ V, $R_{LOAD} = 10$ $\Omega$ , $T_A = 25$ °C	-	4	10	
<b>SiP4280-3 Version</b>						
Output Turn-On Delay Time	$T_{D(ON)}$	$V_{IN} = 5$ V, $R_{LOAD} = 10$ $\Omega$ , $T_A = 25$ °C	-	20	40	$\mu$ S
Output Turn-On Rise Time	$T_{ON}$	$V_{IN} = 5$ V, $R_{LOAD} = 10$ $\Omega$ , $T_A = 25$ °C	-	100	150	
Output Turn-Off Delay Time	$T_{D(OFF)}$	$V_{IN} = 5$ V, $R_{LOAD} = 10$ $\Omega$ , $T_A = 25$ °C	-	4	10	
Output Pull-Down Resistance	$R_{PD}$	ON/OFF = inactive, $T_A = 25$ °C	-	150	250	$\Omega$

Notes:

a. The algebraic convention whereby the most negative value is a minimum and the most positive a maximum.

b. Typical values are for DESIGN AID ONLY, not guaranteed nor subject to production testing.

c. Part requires minimum start-up of  $V_{IN} \geq 2.0$  to ensure operation down to 1.8 V.d. For  $V_{IN} \leq 2.7$  V see typical ON/OFF threshold curve.

**PIN CONFIGURATION**

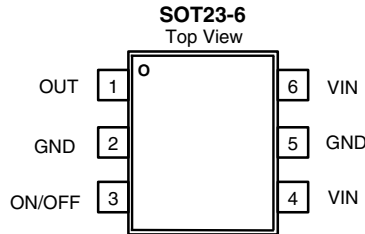

<b>PIN DESCRIPTION</b>		
Pin Number SOT23-6	Pin Name	Symbol
4, 6	VIN	This pin is the P-channel MOSFET source connection
3	ON/OFF	Logic high enables the IC; logic low disables the IC and reduces the IC and reduces the quiescent current to 2.5 $\mu$ A
2, 5	GND	Ground connection
1	OUT	This pin is the P-channel MOSFET drain connection

<b>SELECTION GUIDE</b>			
Part Number	Slew Rate (typ)	Active Pull Down	Enable
SiP4280-1-T1-E3	1 ms	No	Active High
SiP4280-3-T1-E3	100 $\mu$ s	Yes	Active High

<b>ORDERING INFORMATION</b>			
Part Number	Marking	Temperature Range	Package
SiP4280DT-1-T1-E3	L1XXX	- 40 °C to 85 °C	SOT23-6L
SiP4280DT-3-T1-E3	L3XXX		SOT23-6L

**TYPICAL CHARACTERISTICS** internally regulated, 25 °C unless noted

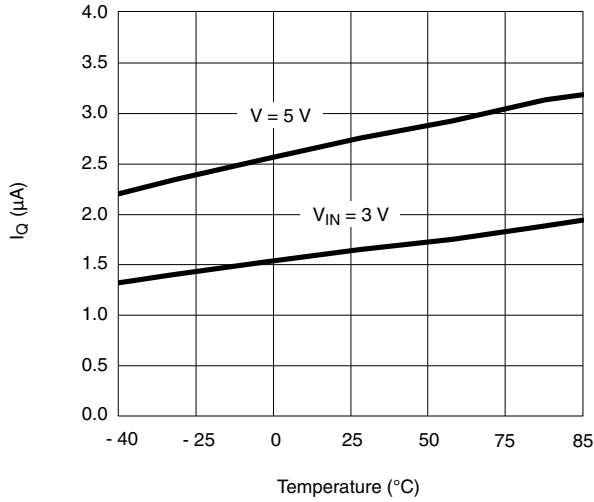

**Quiescent Current vs. Temperature**

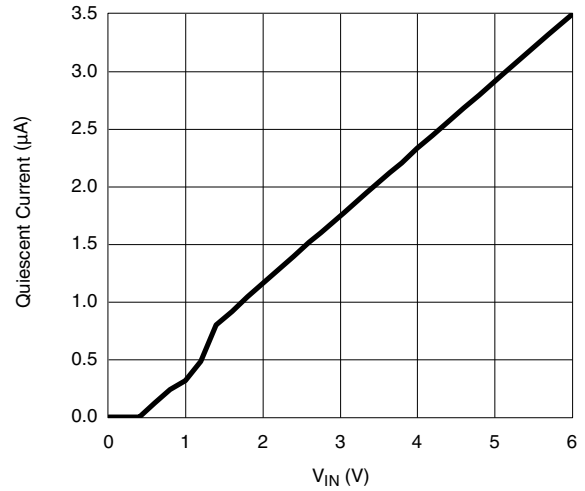

**Quiescent Current vs. Input Voltage**

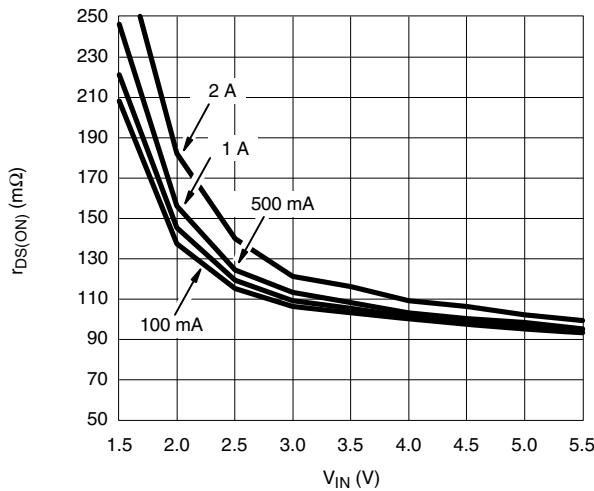

**$R_{DS(ON)}$  vs. Input Voltage**

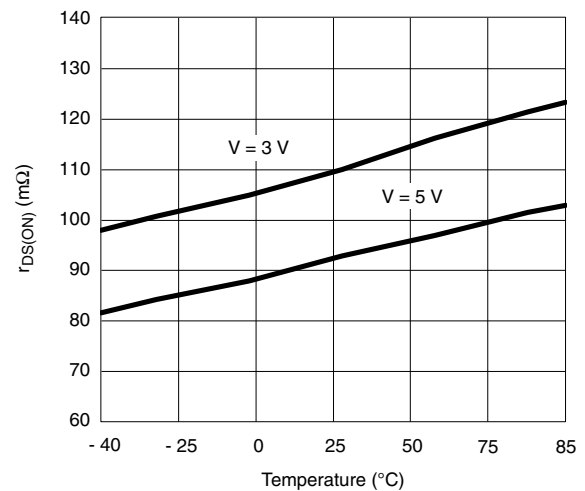

**$R_{DS(ON)}$  vs. Temperature**

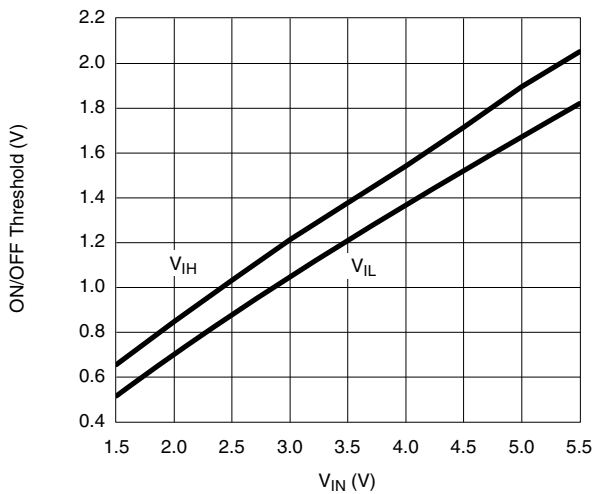

**ON/OFF Threshold vs. Input Voltage**

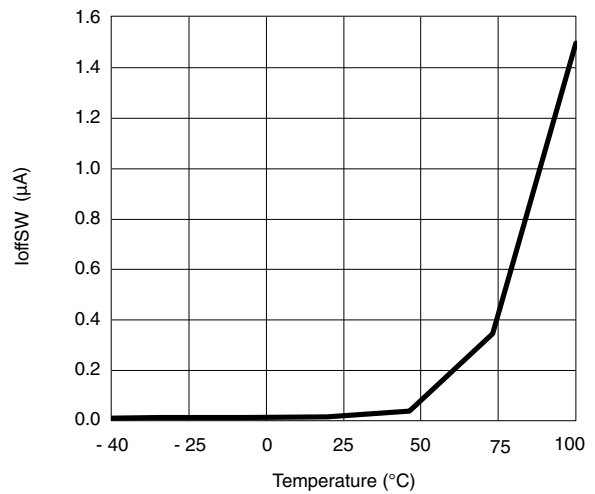

**Off Switch Current vs. Temperature**

**TYPICAL WAVEFORMS**

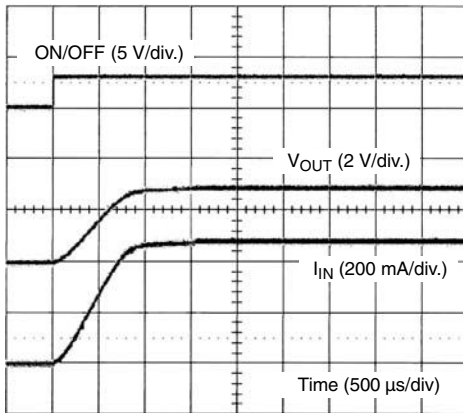

SiP4280-1 Turn-On ( $V_{IN} = 3\text{ V}$ ,  $R_{LOAD} = 6\ \Omega$ )

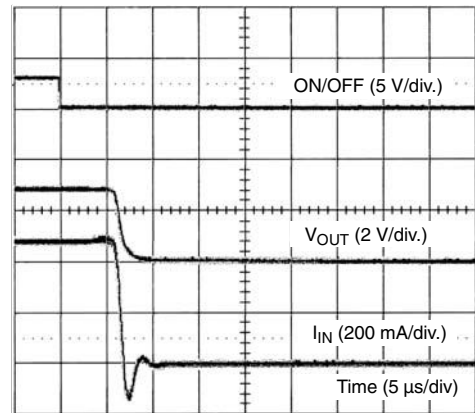

SiP4280-1 Turn-Off ( $V_{IN} = 3\text{ V}$ ,  $R_{LOAD} = 6\ \Omega$ )

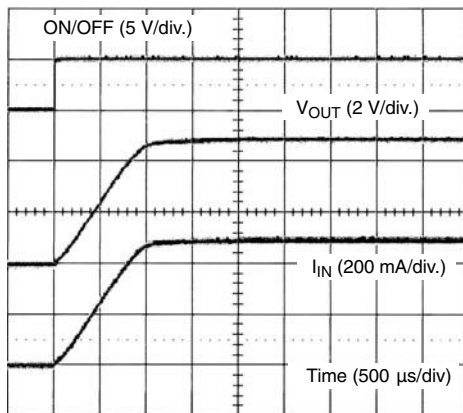

SiP4280-1 Turn-On ( $V_{IN} = 5\text{ V}$ ,  $R_{LOAD} = 10\ \Omega$ )

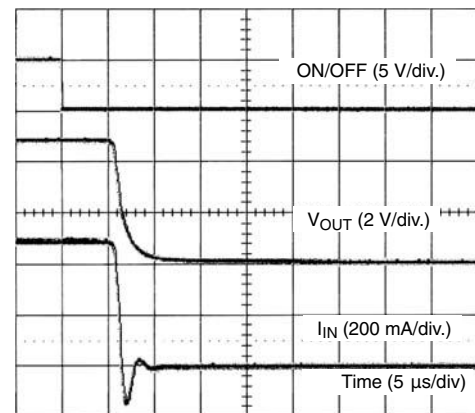

SiP4280-1 Turn-Off ( $V_{IN} = 5\text{ V}$ ,  $R_{LOAD} = 10\ \Omega$ )

### TYPICAL WAVEFORMS

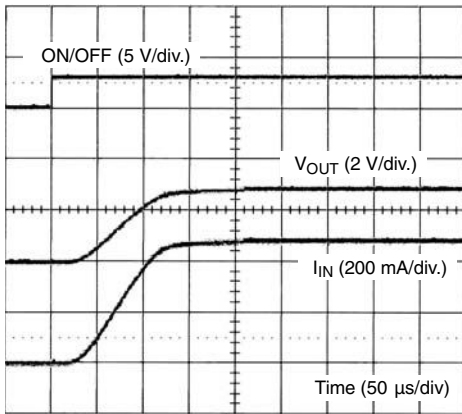

SiP4280-3 Turn-On ( $V_{IN} = 3\text{ V}$ ,  $R_{LOAD} = 6\ \Omega$ )

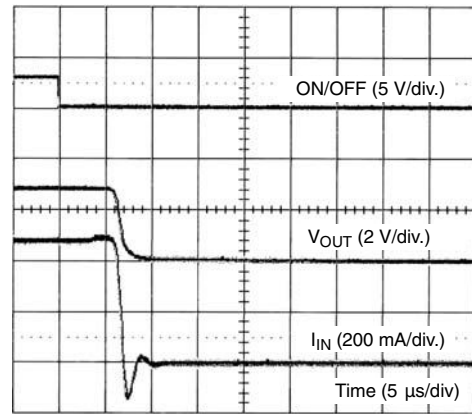

SiP4280-3 Turn-Off ( $V_{IN} = 3\text{ V}$ ,  $R_{LOAD} = 6\ \Omega$ )

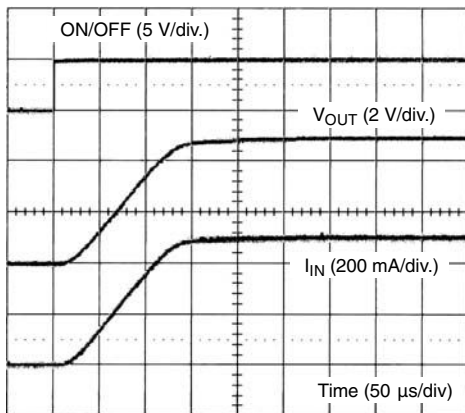

SiP4280-3 Turn-On ( $V_{IN} = 5\text{ V}$ ,  $R_{LOAD} = 10\ \Omega$ )

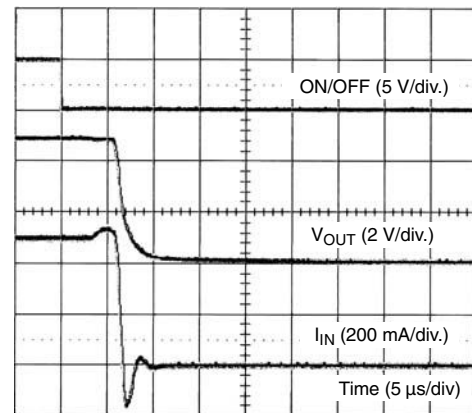

SiP4280-3 Turn-Off ( $V_{IN} = 5\text{ V}$ ,  $R_{LOAD} = 10\ \Omega$ )

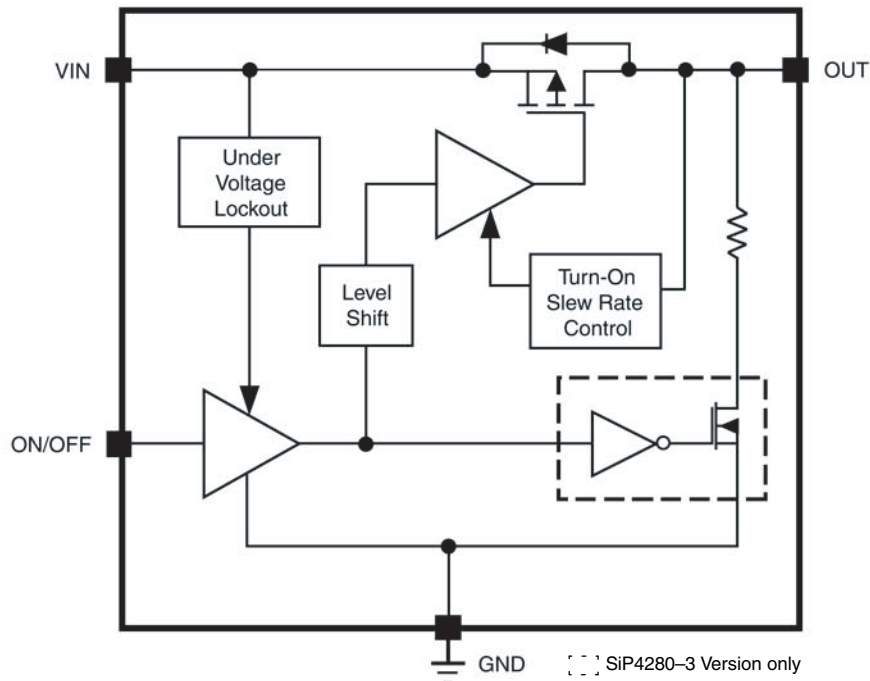
**BLOCK DIAGRAM**

SiP4280 Functional Block Diagramm

**DETAILED DESCRIPTION**

The SiP4280 is a P-Channel MOSFET power switches designed for high-side slew rate controlled load switching applications. Once turned on, the slew-rate control circuitry is activated and current is ramped in a linear fashion until it reaches the level required for the output load condition. This is accomplished by first elevating the gate voltage of the MOSFET up to its threshold voltage and then by linearly increasing the gate voltage until the MOSFET becomes fully enhanced. At this point, the gate voltage is then quickly increased to the full input voltage to reduce  $R_{DS(ON)}$  of the MOSFET switch and minimize any associated power losses.

The SiP4280-1 version has a modest 1 ms turn on slew rate feature, which significantly reduces in-rush current at turned on time and permits the load switch to be implemented with a small input capacitor, or no input capacitor at all, saving cost and space. In addition to a 100  $\mu$ s minimized slew rate, the SiP4280-3 features a shutdown output discharge circuit which is activated at shutdown (when the part is disabled through the ON/OFF pin) and discharges the output pin through a small internal resistor hence, turning off the load.

In instances where the input voltage falls below 1.4 V (typically) the under voltage lock-out circuitry protects the MOSFET switch from entering the saturation region or operation by shutting down the chip.

### APPLICATION INFORMATION

#### Input Capacitor

While a bypass capacitor on the input is not required, a 1  $\mu\text{F}$  or larger capacitor for  $C_{\text{IN}}$  is recommended in almost all applications. The Bypass capacitor should be placed as physically close as possible to the SiP4280 to be effective in minimizing transients on the input. Ceramic capacitors are recommended over tantalum because of their ability to withstand input current surges from low impedance sources such as batteries in portable devices.

#### Output Capacitor

A 0.1  $\mu\text{F}$  capacitor or larger across  $V_{\text{OUT}}$  and GND is recommended to insure proper slew operation.  $C_{\text{OUT}}$  may be increased without limit to accommodate any load transient condition with only minimal affect on the SiP4280 turn on slew rate time. There are no ESR or capacitor type requirement.

#### Enable

The ON/OFF pin is compatible with both TTL and CMOS logic voltage levels.

#### Reverse Voltage Conditions and Protection

The P-Channel MOSFET pass transistor has an intrinsic diode that is reversed biased when the input voltage is greater than the output voltage. Should  $V_{\text{OUT}}$  exceed  $V_{\text{IN}}$ , this intrinsic diode will become forward biased and allow excessive current to flow into the IC thru the  $V_{\text{OUT}}$  pin and potentially damage the IC device. Therefore extreme care should be taken to prevent  $V_{\text{OUT}}$  from exceeding  $V_{\text{IN}}$ .

In conditions where  $V_{\text{OUT}}$  exceeds  $V_{\text{IN}}$  a Schottky diode in parallel with the internal intrinsic diode is recommended to protect the SiP4280.

*Vishay Siliconix maintains worldwide manufacturing capability. Products may be manufactured at one of several qualified locations. Reliability data for Silicon Technology and Package Reliability represent a composite of all qualified locations. For related documents such as package/tape drawings, part marking, and reliability data, see <http://www.vishay.com/ppg?73476>*



### Thin SOT-23 : 5- and 6-Lead (Power IC only)

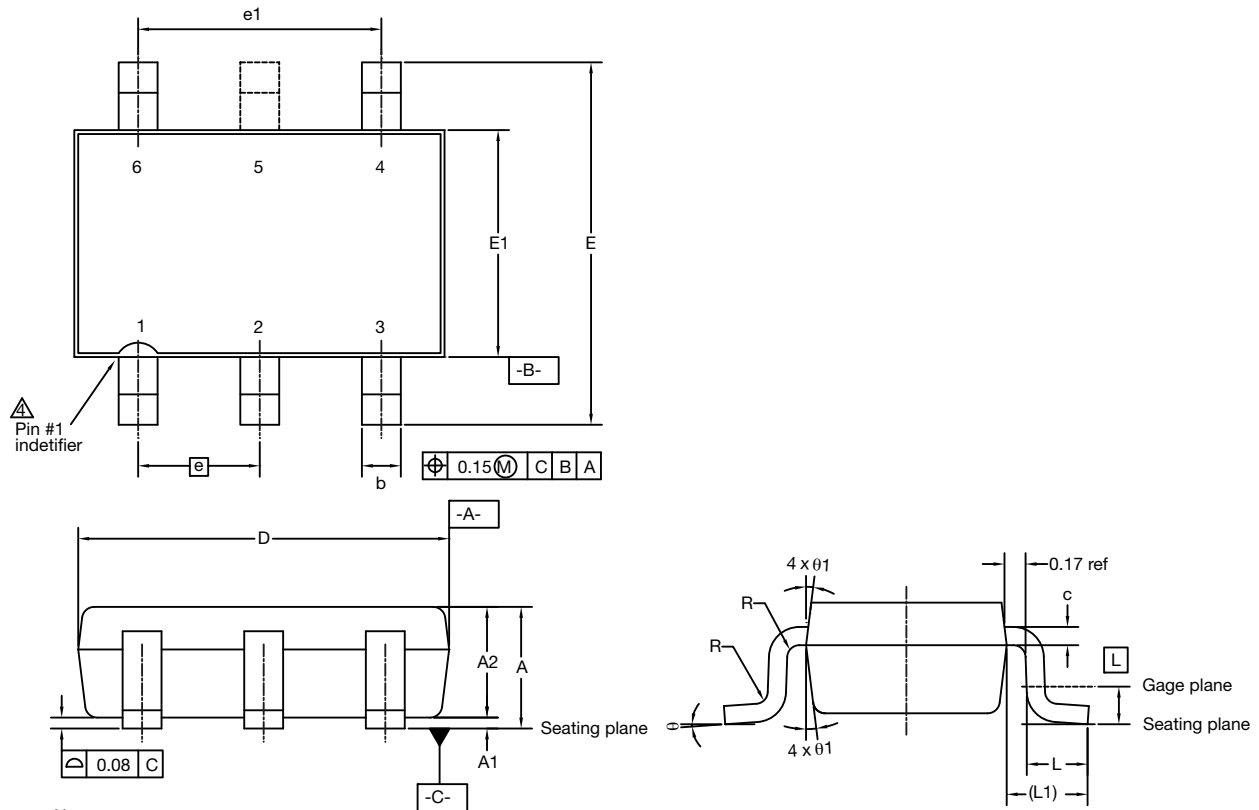

- Notes:
1. Use millimeters as the primary measurement.
  2. Dimensioning and tolerances conform to ASME Y14.5M. - 1994.
  3. This part is fully compliant with JEDEC MO-193.
- Detail of Pin #1 indentifier is optional.

DIM.	MILLIMETERS			INCHES		
	MIN.	NOM.	MAX.	MIN.	NOM.	MAX.
A	0.91	1.00	1.10	0.036	0.039	0.043
A1	0.00	0.05	0.10	0.000	0.002	0.004
A2	0.85	0.90	1.00	0.033	0.035	0.039
b	0.30	0.40	0.45	0.012	0.016	0.018
c	0.10	0.15	0.20	0.004	0.006	0.008
D	2.85	2.95	3.10	0.112	0.116	0.122
E	2.70	2.85	2.98	0.106	0.112	0.117
E1	1.525	1.65	1.70	0.060	0.065	0.067
e	0.95 BSC			0.0374 BSC		
L	0.30	0.40	0.50	0.014	-	0.020
L1	0.60 ref.			0.024 BSC		
L2	0.25 BSC			0.010 BSC		
$\theta$	0°	4°	8°	0°	4°	8°
$\theta_1$	4°	10°	12°	4°	10°	12°

ECN: E13-1126-Rev. B, 01-Jul-13  
 DWG: 5926



## Disclaimer

ALL PRODUCT, PRODUCT SPECIFICATIONS AND DATA ARE SUBJECT TO CHANGE WITHOUT NOTICE TO IMPROVE RELIABILITY, FUNCTION OR DESIGN OR OTHERWISE.

Vishay Intertechnology, Inc., its affiliates, agents, and employees, and all persons acting on its or their behalf (collectively, "Vishay"), disclaim any and all liability for any errors, inaccuracies or incompleteness contained in any datasheet or in any other disclosure relating to any product.

Vishay makes no warranty, representation or guarantee regarding the suitability of the products for any particular purpose or the continuing production of any product. To the maximum extent permitted by applicable law, Vishay disclaims (i) any and all liability arising out of the application or use of any product, (ii) any and all liability, including without limitation special, consequential or incidental damages, and (iii) any and all implied warranties, including warranties of fitness for particular purpose, non-infringement and merchantability.

Statements regarding the suitability of products for certain types of applications are based on Vishay's knowledge of typical requirements that are often placed on Vishay products in generic applications. Such statements are not binding statements about the suitability of products for a particular application. It is the customer's responsibility to validate that a particular product with the properties described in the product specification is suitable for use in a particular application. Parameters provided in datasheets and / or specifications may vary in different applications and performance may vary over time. All operating parameters, including typical parameters, must be validated for each customer application by the customer's technical experts. Product specifications do not expand or otherwise modify Vishay's terms and conditions of purchase, including but not limited to the warranty expressed therein.

Hyperlinks included in this datasheet may direct users to third-party websites. These links are provided as a convenience and for informational purposes only. Inclusion of these hyperlinks does not constitute an endorsement or an approval by Vishay of any of the products, services or opinions of the corporation, organization or individual associated with the third-party website. Vishay disclaims any and all liability and bears no responsibility for the accuracy, legality or content of the third-party website or for that of subsequent links.

Except as expressly indicated in writing, Vishay products are not designed for use in medical, life-saving, or life-sustaining applications or for any other application in which the failure of the Vishay product could result in personal injury or death. Customers using or selling Vishay products not expressly indicated for use in such applications do so at their own risk. Please contact authorized Vishay personnel to obtain written terms and conditions regarding products designed for such applications.

No license, express or implied, by estoppel or otherwise, to any intellectual property rights is granted by this document or by any conduct of Vishay. Product names and markings noted herein may be trademarks of their respective owners.