

LTM4664 48V_{IN}, Dual 25A μ Module Regulator With Digital Power System Management

DESCRIPTION

Demonstration circuit 2672A-A is a complete non-isolated 48V input, dual-output, high efficiency, high density μ Module regulator with 30V to 58V input range. Each output can supply 25A maximum load current. The demo board has a LTM4664 μ Module regulator, which is a dual 25A or single 50A step-down regulator with digital power system management. Please see the LTM4664 datasheet for more detailed information.

DC2672A-A powers up to default settings and produces power based on configuration resistors without the need for any serial bus communication. This allows easy evaluation of the DC/DC converter. To fully explore the extensive power system management features of the part, download

the GUI software LTpowerPlay™ onto your PC and use ADI's I²C/SMBus/PMBus dongle DC1613A to connect to the board. LTpowerPlay allows the user to reconfigure the part on the fly and store the configuration in EEPROM, view telemetry of voltage, current, temperature and fault status.

GUI Download

[The software can be downloaded here.](#)

For more details and instructions of LTpowerPlay, please refer to LTpowerPlay GUI for LTM4664 Quick Start Guide.

[Design files for this circuit board are available.](#)

All registered trademarks and trademarks are the property of their respective owners.

BOARD PHOTO

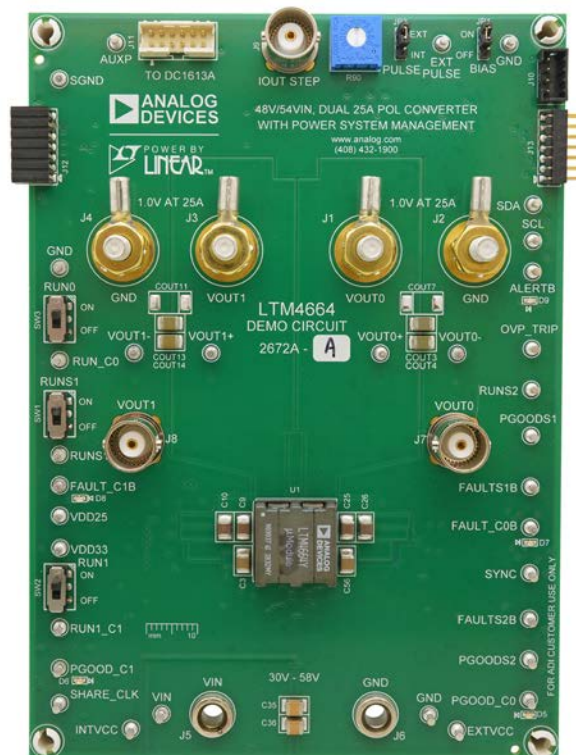

Figure 1. Dual-output LTM4664/DC2672A-A Demo Circuit

DEMO MANUAL DC2672A-A

PERFORMANCE SUMMARY Specifications are at $T_A = 25^\circ\text{C}$

PARAMETER	CONDITIONS	VALUE
Input Voltage Range		30V to 58V
Output Voltage, V_{OUT0}	$V_{IN} = 30\text{-}58\text{V}$, $I_{OUT0} = 0\text{A to }25\text{A}$	0.5 to 1.5V, Default: 1.0V
Maximum Output Current, I_{OUT0}	$V_{IN} = 30\text{-}58\text{V}$, $V_{OUT0} = 0.5\text{V to }1.5\text{V}$	25A
Output Voltage, V_{OUT1}	$V_{IN} = 30\text{-}58\text{V}$, $I_{OUT1} = 0\text{A to }25\text{A}$	0.5 to 1.5V, Default: 1.0V
Maximum Output Current, I_{OUT1}	$V_{IN} = 30\text{-}58\text{V}$, $V_{OUT1} = 0.5\text{V to }1.5\text{V}$	25A
Typical Efficiency of CH0	$V_{IN} = 48\text{V}$, $V_{OUT0} = 1.0\text{V}$, $I_{OUT0} = 25\text{A}$	87.0% (See Figure 5)
Typical Efficiency of CH1	$V_{IN} = 48\text{V}$, $V_{OUT1} = 1.5\text{V}$, $I_{OUT1} = 25\text{A}$	89.4% (See Figure 6)
Default Switching Frequency		250kHz

QUICK START PROCEDURE

Table 1. LTM4664 Demo Boards for up to 200A Point-of-Load Regulation

MAXIMUM OUTPUT CURRENT	NUMBER OF OUPUTS	NUMBER OF LTM4664 μ MODULE REGULATORS ON THE BOARD	DEMO BOARD NUMBER
25A	2	1	DC2672A-A
50A	1	1	DC2672A-B
100A	1	2	DC2954A-A
150A	1	3	DC2954A-B
200A	1	4	DC2954A-C

Demonstration circuit 2672A-A is easy to set up to evaluate the performance of the LTM4664. Refer to Figure 2 for the proper measurement equipment setup and follow the procedure below.

1. With power off, connect the input power supply to V_{IN} (30V-58V) and GND (input return).
2. Connect the 1.0V output load between V_{OUT0} and GND (Initial load: no load).
3. Connect the 1.0V output load between V_{OUT1} and GND (Initial load: no load).
4. Connect the DVMs to the input and outputs. Set default jumper position: SW1: ON; SW2: ON; SW3: ON; JP1: OFF; JP2: EXT.
5. Turn on the input power supply and check for the proper output voltages. V_{OUT0} should be $1.0\text{V} \pm 0.5\%$, and V_{OUT1} should be $1.0\text{V} \pm 0.5\%$.

6. Once the proper output voltages are established, adjust the loads within the operating range and observe the output voltage regulation, ripple voltage and other parameters.
7. Connect the dongle and control the output voltages from the GUI. See “LTpowerPlay GUI for the LTM4664 Quick Start Guide” for details.

Note: When measuring the output or input voltage ripple, do not use the long ground lead on the oscilloscope probe. See Figure 3 for the proper scope probe technique. Short, stiff leads need to be soldered to the (+) and (-) terminals of an output capacitor. The probe's ground ring needs to touch the (-) lead and the probe tip needs to touch the (+) lead.

QUICK START PROCEDURE

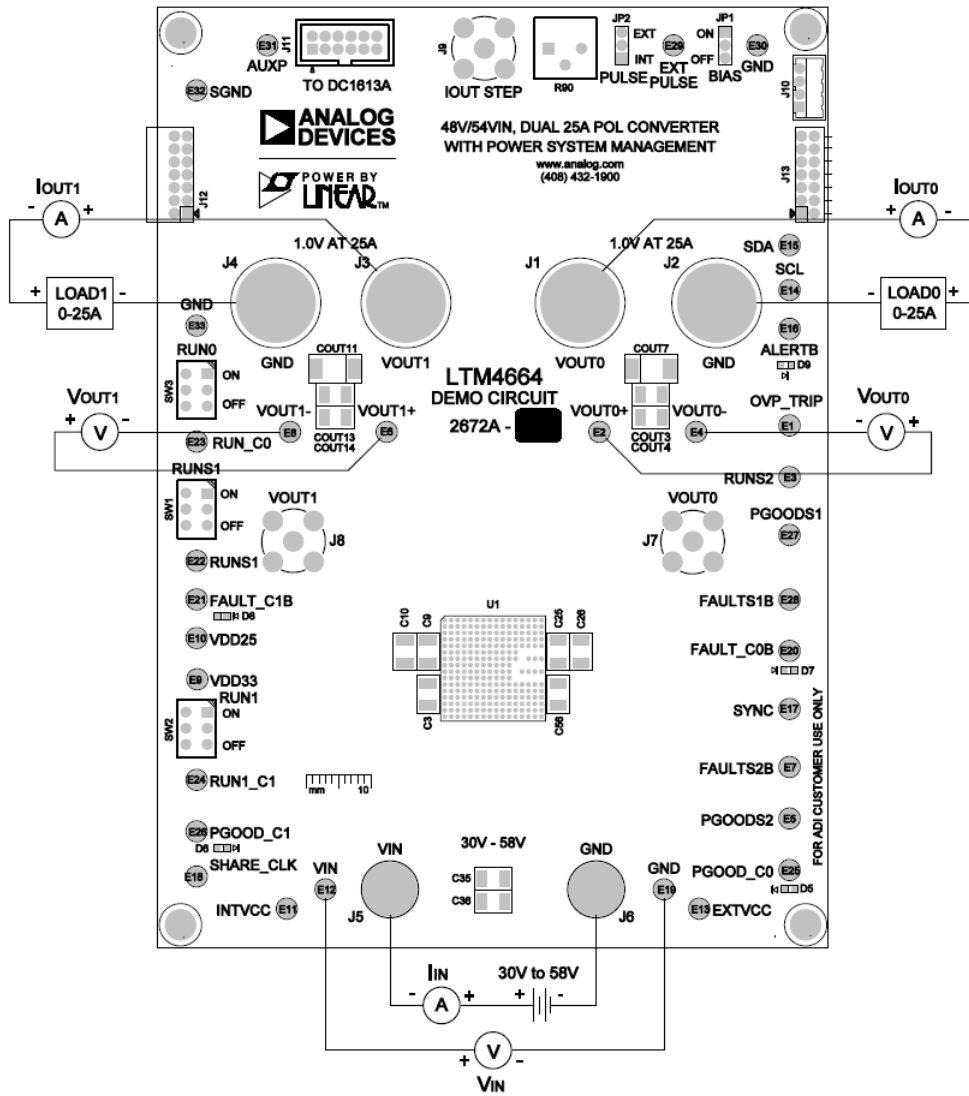

Figure 2. Proper Measurement Equipment Setup

QUICK START PROCEDURE

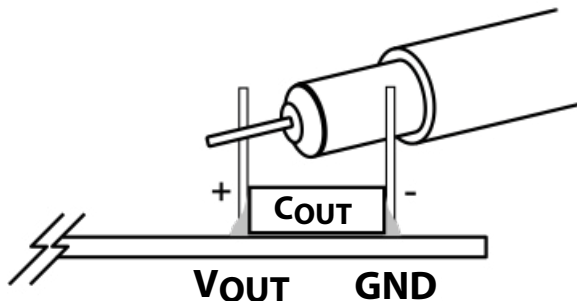

Figure 3. Measuring Output Voltage Ripple

Connecting a PC to DC2672A-A

You can use a PC to reconfigure the power management features of the LTM4664 such as: nominal V_{OUT} ,

margin set points, OV/UV limits, temperature fault limits, sequencing parameters, the fault log, fault responses, GPIOs and other functionalities. The DC1613A dongle may be plugged when V_{IN} is present.

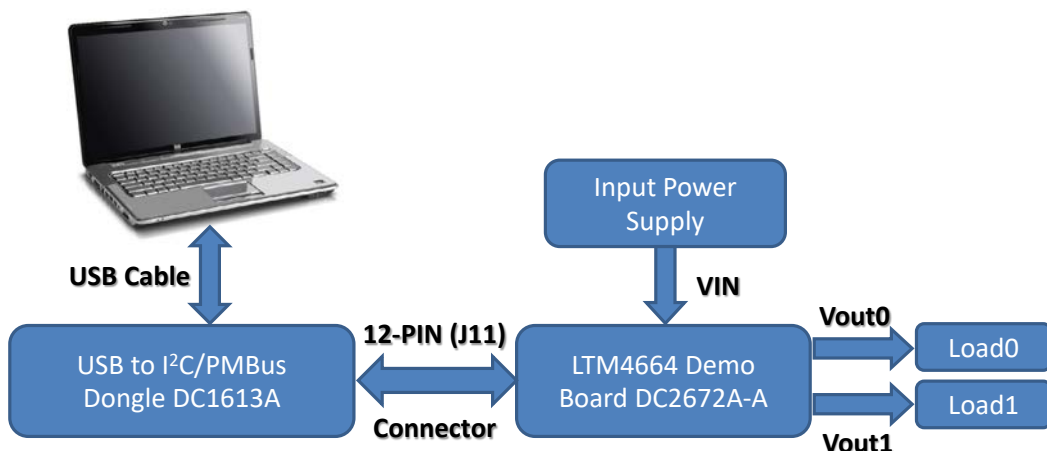

Figure 4. Demo setup with PC

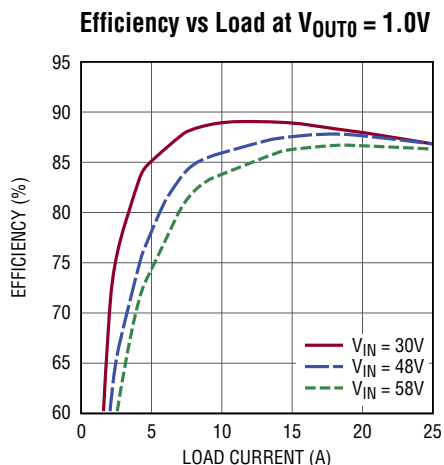

Figure 5. Efficiency vs. Load Current on CH0 (CH1 is Disabled)

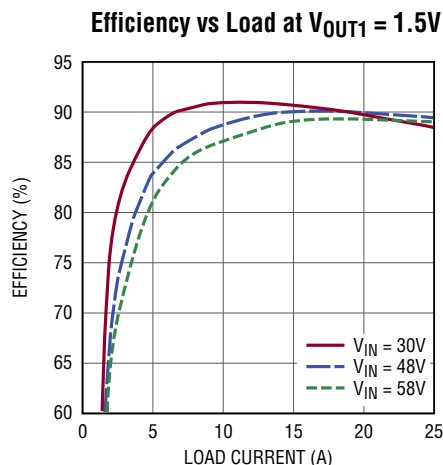

Figure 6. Efficiency vs. Load Current on CH1 (CH0 is Disabled)

QUICK START PROCEDURE

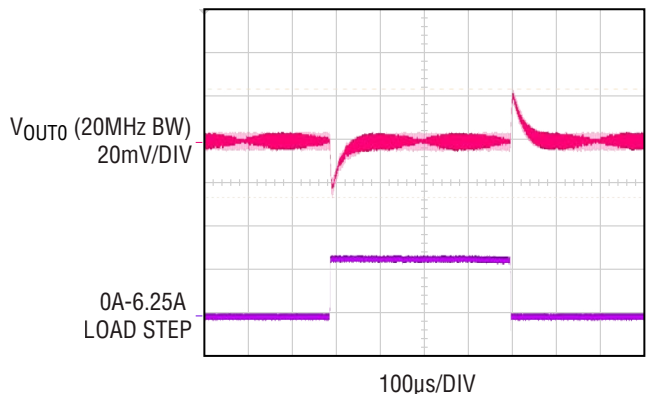

Figure 7. V_{OUT0} Load Transient Response at $V_{IN} = 48V$, $V_{OUT0} = 1.0V$

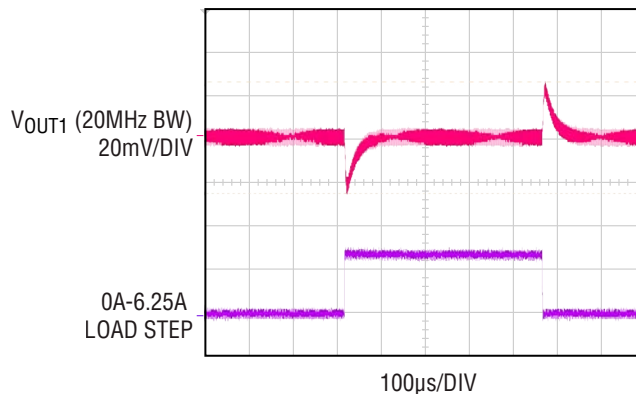

Figure 8. V_{OUT1} Load Transient Response at $V_{IN} = 48V$, $V_{OUT1} = 1.0V$

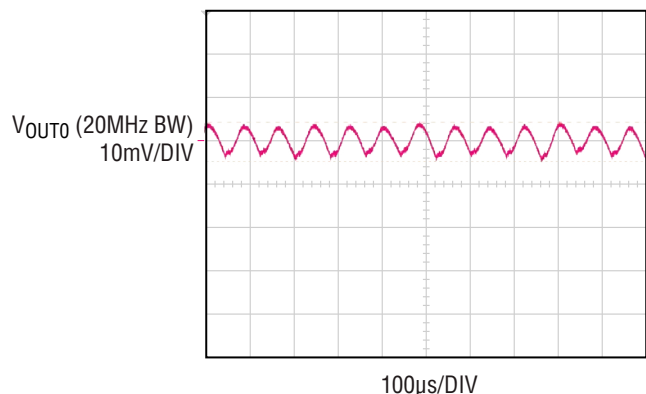

Figure 9. V_{OUT0} Voltage Ripple at $V_{IN} = 48V$, $V_{OUT0} = 1.0V$, $I_{OUT0} = 25A$

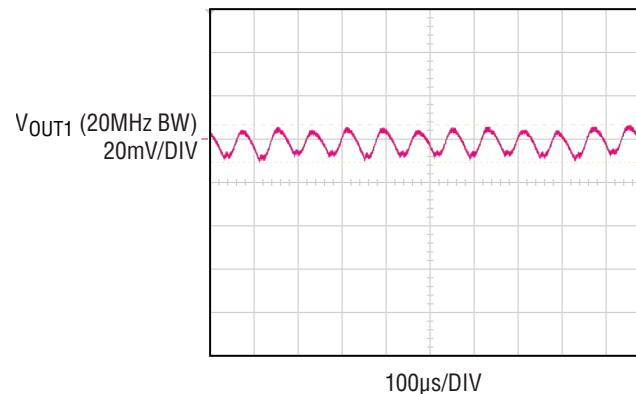

Figure 10. V_{OUT1} Voltage Ripple at $V_{IN} = 48V$, $V_{OUT1} = 1.0V$, $I_{OUT1} = 25A$



Figure 11. Thermal at $V_{IN} = 48V$, $V_{OUT0} = 1.0V$, $I_{OUT0} = 25A$, $V_{OUT1} = 1.0V$, $I_{OUT1} = 25A$, $T_A = 25^\circ C$, No Airflow

DEMO MANUAL DC2672A-A

QUICK START PROCEDURE

LTpowerPlay Software GUI

LTpowerPlay is a powerful Windows based development environment that supports Analog Devices power system management ICs and μ Modules, including LTM4675, LTM4676, LTM4677, LTM4678, LTM4680, LTM4700, LTM4664, LTC3880, LTC3882, LTC3883 and LTC3884. The software supports a variety of different tasks. You can use LTpowerPlay to evaluate Analog Devices ICs by connecting to a demo board system. LTpowerPlay can also be used in an offline mode (with no hardware present) in order to build a multichip configuration file that can be saved and reloaded at a later time. LTpowerPlay provides unprecedented diagnostic and debug features. It becomes a valuable diagnostic tool during board bring-up

to program or tweak the power management scheme in a system, or to diagnose power issues when bringing up rails. LTpowerPlay utilizes the DC1613A USB-to-SMBus controller to communicate with one of many potential targets, including LTM4675, LTM4676, LTM4677, LTM4678, LTM4680, LTM4700, LTM4664, LTC3880, LTC3882, LTC3883 and LTC3884's demo system, or a customer board. The software also provides an automatic update feature to keep the software current with the latest set of device drivers and documentation. [The LTpowerPlay software can be downloaded here.](#)

To access technical support documents for LTC Digital Power Products visit the LTpowerPlay Help menu. Online help also available through the LTpowerPlay.

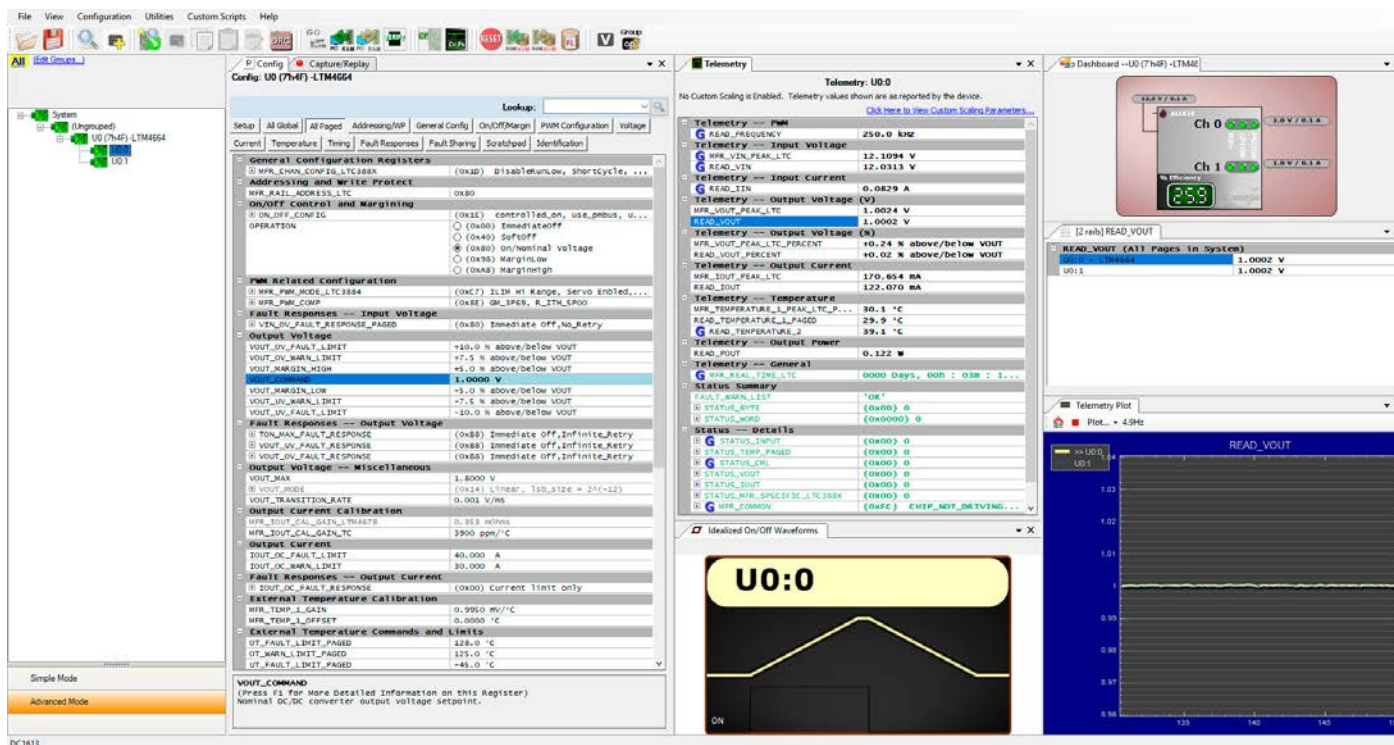

Figure 12. LTpowerPlay Main Interface

QUICK START PROCEDURE

LTPowerPlay Quick Start Procedure

The following procedure describes how to use LTPowerPlay to monitor and change the settings of LTM4664.

1. Download and install the [LTPowerPlay GUI](#):
2. Launch the LTPowerPlay GUI.
 - a. The GUI should automatically identify the DC2672A-A. The system tree on the left hand side should look like this:

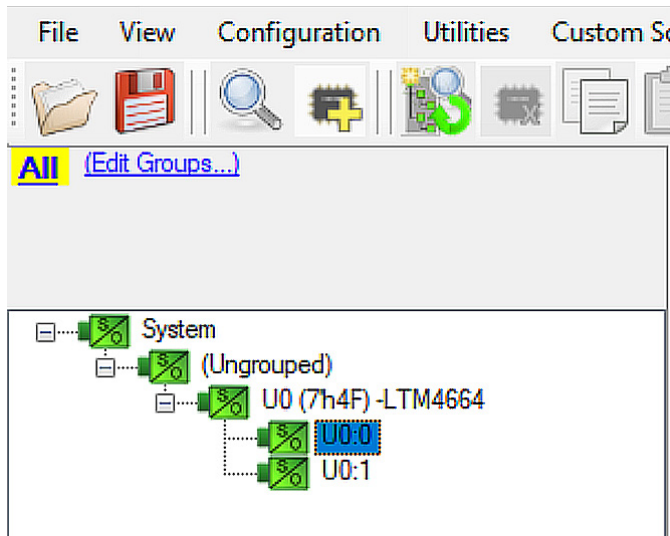

- b. A green message box shows for a few seconds in the lower left hand corner, confirming that LTM4664 is communicating:

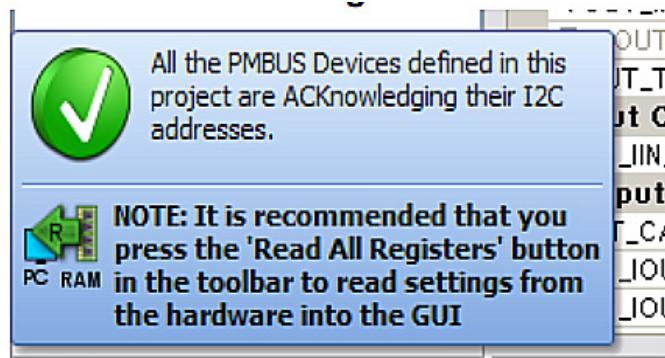

- c. In the Toolbar, click the “R” (RAM to PC) icon to read the RAM from the LTM4664. This reads the configuration from the RAM of LTM4664 and loads it into the GUI.



- d. If you want to change the output voltage to a different value, like 1.5V. In the Config tab, type in 1.5 in the VOUT_COMMAND box, like this:

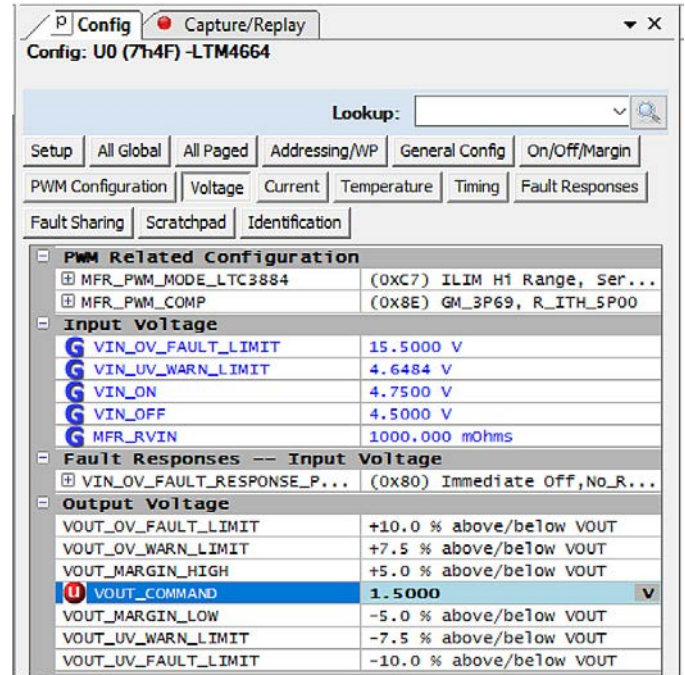

- Then, click the “W” (PC to RAM) icon to write these register values to the LTM4664. After finishing this step, you will see the output voltage will change to 1.5V.



- If the write is successful, you will see the following message:

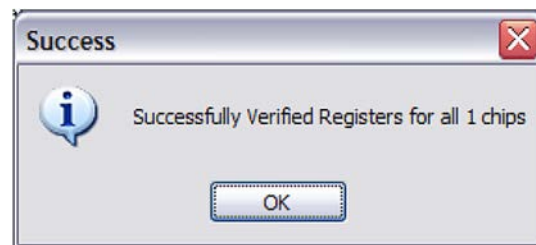

- e. You can save the changes into the NVM. In the tool bar, click “RAM to NVM” button, as following



- f. Save the demo board configuration to a (*.proj) file. Click the Save icon and save the file. Name it whatever you want.

DEMO MANUAL DC2672A-A

PARTS LIST

ITEM	QTY	REFERENCE	PART DESCRIPTION	MANUFACTURER/PART, NUMBER
Required Circuit Components				
1	4	COUT1, COUT2, COUT9, COUT12	CAP, 1210 100uF 20% 6.3V X5R	AVX, 12106D107MAT2A
2	8	COUT3, COUT4, COUT5, COUT6, COUT10, COUT13, COUT14, COUT15	CAP, 1210 330uF 20% 4V X5R	TAIYO YUDEN, AMK325ABJ337MM-P
3	2	C1, C19	CAP, 0603 3900pF 5% 50V COG	KEMET, C0603C392J5GACAU0
4	4	C2, C3, C56, C57	CAP, 1210 22uF 20% 25V X7R	AVX, 12103C226MAT2A
5	18	C4, C5, C9, C10, C11, C12, C13, C14, C20, C21, C23, C24, C25, C26, C27, C28, C29, C30	CAP, 1210 10uF 10% 50V X7R	MURATA, GRM32ER71H106KA12L
6	2	C8, C22	CAP, 22pF, COG, 50V, 5%, 0603	AVX, 06035A220JAT2A
7	2	C16, C43	CAP, 0603 0.47uF 10% 16V X7R	KEMET, C0603C474K4RAC7800
8	6	C17, C18, C31, C32, C41, C42	CAP, 0603 4.7uF 20% 25V X5R	TDK, C1608X5R1E475M080AC
9	1	C34	CAP, 33uF 20% 80V ALUM.	PANASONIC, EEH3C1K330P
10	6	C35, C36, C37, C38, C39, C40	CAP, 1210 2.2uF 10% 100V X7R	MURATA, GRM32ER72A225KA35L
11	1	C44	CAP, 0.01uF, X7R, 16V, 10%, 0603	AVX, 0603YC103KAT2A
12	1	RS1	RES, 1206 0.002 OHMS 1% 1W	PANASONIC, ERJMP2MF2M0U
13	1	RS3	RES, 1206 0.01 OHMS 1% 1W	PANASONIC, ERJMP2MF10MU
14	4	R1, R7, R16, R23	RES, 0603 10 OHMS 1% 1/10W	VISHAY, CRCW060310R0FKEA
15	5	R4, R13, R17, R18, R117	RES, 0603 0 OHMS JUMPER	VISHAY, CRCW06030000Z0EA
16	16	R9, R10, R25, R26, R27, R28, R29, R30, R31, R32, R33, R34, R35, R36, R41, R42	RES, 0603 10k OHMS 1% 0.1W	VISHAY, CRCW060310K0FKEA
17	1	R14	RES, 0603 10.5k OHMS, 1%, 1/10W	VISHAY, CRCW060310K5FKEA
18	1	R19	RES, 0603 64.9k OHMS 1% 0.1W	VISHAY, CRCW060364K9FKEA
19	2	R20, R37	RES, 0603 100k OHMS 1% 1/10W	VISHAY, CRCW0603100KFKEA
20	1	R24	RES, 0603 75k OHMS 1% 1/10W	VISHAY, CRCW060375K0FKEA
21	1	R38	RES, 100k OHMS, 1%, 1/8W, 0805, AEC-Q200	NIC, NRC10F1003TRF
22	1	R39	RES, 0603 40.2k OHMS 1% 1/10W	VISHAY, CRCW060340K2FKEA
23	1	R40	RES, 0603 4.99k OHMS, 1%, 1/10W	PANASONIC, ERJ3EKF4991V
24	1	R55	RES, 0603 130k OHMS 1% 0.1W	VISHAY, CRCW0603130KFKEA
25	1	R57	RES, 0603 9.76k OHMS, 1%, 1/10W	VISHAY, CRCW06039K76FKEA
26	1	U1	IC, Module	ANALOG DEVICES, LTM4664EY
Additional Demo Board Circuit Components				
1	0	COUT7, COUT8, COUT11, COUT16	CAP, 7343 OPTION	OPTION
2	0	C15	CAP, 0603 OPTION	OPTION
3	0	D1	DIODE, OPTION	OPTION
4	0	D3, D4	DIODE, SCHOTTKY 30V, 100mA OPTION	CENTRAL SEMI, CMDSH-3-TR, OPTION

PARTS LIST

ITEM	QTY	REFERENCE	PART DESCRIPTION	MANUFACTURER/PART, NUMBER
5	0	R2, R3, R5, R6, R11, R12, R15, R21, R22, R43, R44, R45, R46, R47, R48, R49, R51, R52, R53, R54, R56, R58, R59, R61, R62, R64, R65, R67, R69, R92, R93, R95, R97, R99, R100, R105, R106, R107, R108, R109	RES, 0603 OPTION	OPTION
6	0	R60, R63, R66, R68, R75	RES, 2010 OPTION	OPTION
7	2	R70, R71	RES, 1206 100 OHMS 1% 1/4W	PANASONIC, ERJ-8ENF1000V
8	2	C45, C46	CAP, 1210 10uF 10% 16V X7R	MURATA, GRM32DR71C106KA01
9	4	R72, R74, R85, R114	RES, 0603 10K OHMS 5% 1/10W	VISHAY, CRCW060310K0JNEA
10	1	R73	RES, 0603 34.8K OHM 1% 1/10W	VISHAY, CRCW060334K8FKEA
11	1	U2	IC, REGULATOR	ANALOG DEVICES, LT1761ES5-SD
12	1	R79	RES, 0603 154K OHMS 1% 1/10W	VISHAY, CRCW0603154KFKEA
13	2	R80, R83	RES, 0603 20K OHMS 5% 1/10W	VISHAY, CRCW060320K0JNEA
14	1	R77	RES, 2010 0 OHM JUMPER	VISHAY, WSL201000000ZEA9
15	4	R78, R94, R96, R98	RES, 0603 0 OHMS JUMPER	VISHAY, CRCW060300000Z0EA
16	1	R82	RES, 0603 1M OHMS 5% 1/10W	VISHAY, CRCW06031M00JNEA
17	1	R84	RES, 0603 681K OHMS 1% 1/10W	VISHAY, CRCW0603681KFKEA
18	1	U3	IC, LTC6992	ANALOG DEVICES, LTC6992IS6-1
19	1	U4	IC, SINGLE OP AMP	ANALOG DEVICES, LT1803IS5
20	2	C49, C53	CAP, 0603 100nF 20% 16V X7R	AVX, 0603YC104MAT2A
21	1	R86	RES, 0603 182 OHMS 1% 1/10W	VISHAY, CRCW0603182RFKEA
22	1	R90	RES, VARIABLE 5K	BOURNS, 3386P-1-502-LF
23	1	R91	RES, 0603 649 OHMS 1% 1/10W	VISHAY, CRCW0603649RFKEA
24	1	R81	RES, 0603 3.3 OHMS 1% 1/10W	VISHAY, CRCW06033R30FKEA
25	1	R87	RES, 0603 82.5 OHMS 1% 1/10W	VISHAY, CRCW060382R5FKEA
26	1	C50	CAP, 0603 150pF 5% 50V NPO	AVX, 06035A151JAT2A
27	1	R76	RES, 0603 2 OHMS 5% 1/10W	VISHAY, CRCW06032R00JNEA
28	1	R88	RES, 2512 0.01 OHMS 1% 1W	VISHAY, WSL2512R0100FEA
29	1	Q1	XSTR, MOSFET, N-CHANNEL 40V	VISHAY, SUD50N04-8M8P-4GE3
30	4	COUT21, COUT25, C51, C52	CAP, 0603 1uF 20% 25V X5R	AVX, 06033D105MAT2A
31	6	COUT19, COUT20, COUT23, COUT24, C47, C48	CAP, 1210 100uF 20% 6.3V X5R	AVX, 12106D107MAT2A
32	4	COUT17, COUT18, COUT22,	CAP, 7343 470uF 20% 2.5V SPCAP	PANASONIC, EEF-GX0E471L
33	1	U5	IC, 24LC05-I/ST	MICROCHIP, 24LC025-I/ST
34	2	R103, R104	RES, 0603 4.99K OHMS 1% 0.1W	VISHAY, CRCW06034K99FKEA
35	3	R110, R111, R115	RES, 0603 127 OHMS 1% 1/10W	VISHAY, CRCW0603127RFKEA
36	2	R112, R113	RES, 0603 200 OHMS 5% 1/10W	VISHAY, CRCW0603200RJNEA
37	1	R116	RES, 0603 15.8K OHMS 1% 1/10W	VISHAY, CRCW060315K8FKEA
38	1	D2	DIODE, ULTRA LOW SCHOTTKY RECTIFIER	NXP SEMI., PMEG2005AEL, 315
39	2	D5, D6	LED, 0603 GREEN	WURTH ELEKTRONIK, 150060GS75000

DEMO MANUAL DC2672A-A

PARTS LIST

ITEM	QTY	REFERENCE	PART DESCRIPTION	MANUFACTURER/PART, NUMBER
40	3	D7, D8, D9	LED, 0603 RED	WURTH ELEKTRONIK, 150060SS75000
41	4	Q3, Q4, Q6, Q7	XSTR, P-CHANNEL DMOS FET	DIODES INC., DMP3130L-7
42	2	Q5, Q8	XSTR, N-CHANNEL DMOS FET	DIODES, INC., 2N7002A-7
43	2	R101, R102	RES, 0603 10 OHMS 5% 1/10W	VISHAY, CRCW060310R0JNEA
44	2	C54, C55	CAP, 0603 10nF 10% 25V X7R	AVX, 06033C103KAT2A

Hardware: For Demo Board Only

1	33	E1, E2, E3, E4, E5, E6, E7, E8, E9, E10, E11, E12, E13, E14, E15, E16, E17, E18, E19, E20, E21, E22, E23, E24, E25, E26, E27, E28, E29, E30, E31, E32, E33	TURRET 1.64mm	MILL-MAX, 2308-2-00-80-00-00-07-0
2	2	JP1, JP2	HEADER, SINGLE ROW 3PIN	WURTH ELEKTRONIK, 62000311121
3	4	J1, J2, J3, J4	STUD, TEST PIN	PEM, KFH-032-10
4	2	J5, J6	BANANA JACK	KEYSTONE, 575-4
5	3	J7, J8, J9	CONN, BNC, 5 PINS	CONNEX, 112404
6	1	J10	HEADER, 4PIN 2mm STR DL	HIROSE, DF3A-4P-2DSA
7	1	J11	HEADER, 12PIN 2mm STR DL	FCI, 98414-G06-12ULF
8	1	J12	CONN, SOCKET 14PIN DUAL ROW R/A	SULLINS INC., NPPN072FJFN-RC
9	1	J13	HEADER, 14PIN DUAL ROW R/A	MOLEX, 87760-1416
10	4	J1, J2, J3, J4	LUG RING, #10	KEYSTONE, 8205
11	4	MH1, MH2, MH3, MH4	STANDOFF, SNAP ON	KEYSTONE, 8834
12	8	J1, J2, J3, J4	NUT, BRASS 10-32	PENCOM, NU1132
13	3	SW1, SW2, SW3	SWITCH, SUBMINATURE SLIDE	C&K, JS202011CQN
14	4	J1, J2, J3, J4	WASHER, #10 TIN PLATED BRASS	PENCOM, WA4526
15	2	XJP1, XJP2	SHUNT	WURTH ELEKTRONIK, 60800213421

SCHEMATIC DIAGRAM

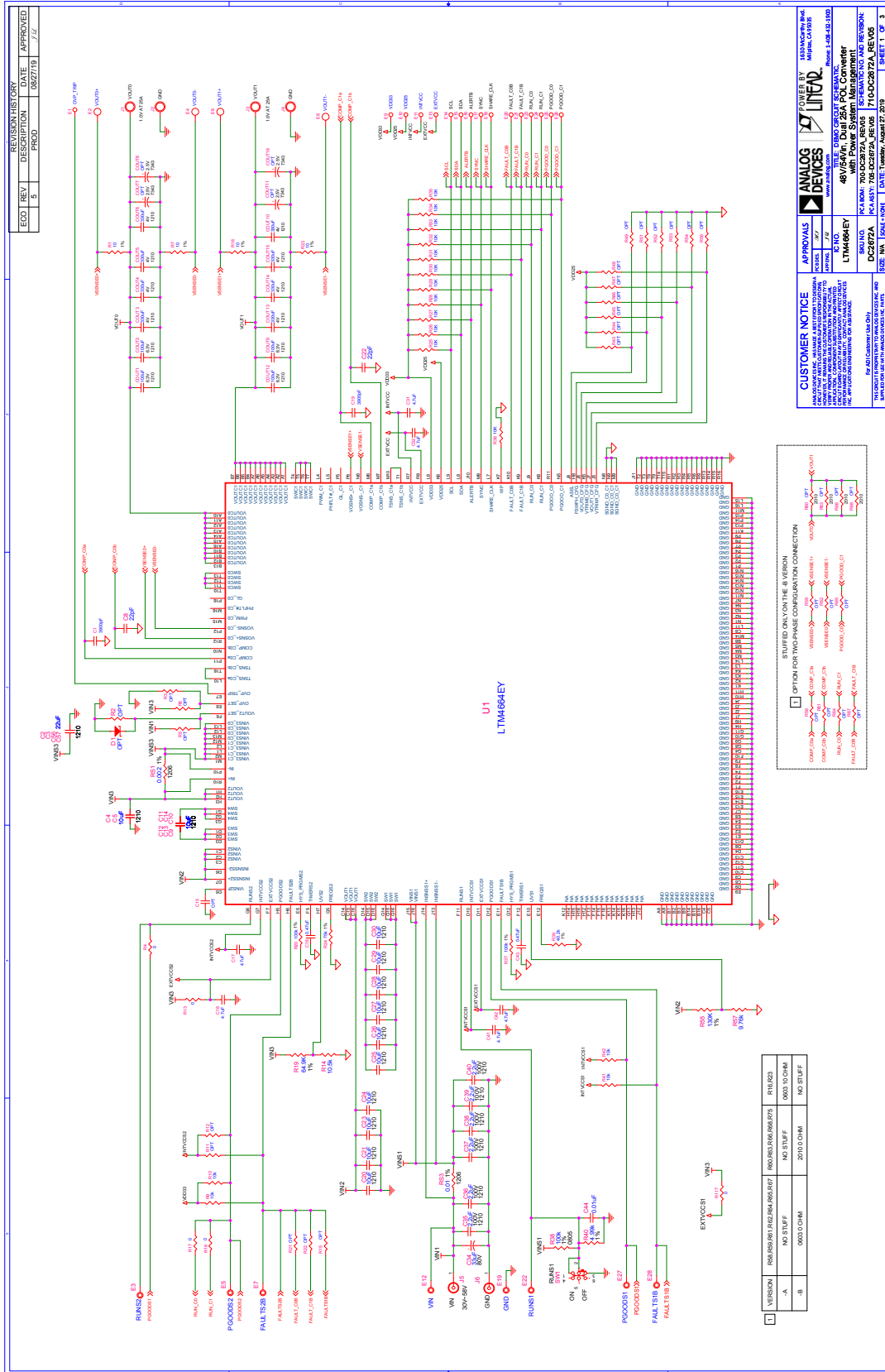

CUSTOMER NOTICE

ANALOG DEVICES, INC. HAS MADE A REVISION TO THIS DEMO BOARD. THE REVISION IS A CHANGE IN THE BOARD LAYOUT TO ACCOMMODATE THE NEW LTM484EY. THE BOARD IS NOW AVAILABLE IN TWO VERSIONS: VERSION A AND VERSION B. VERSION A IS THE ORIGINAL BOARD AND VERSION B IS THE REVISIONED BOARD. THE BOARD IS NOW AVAILABLE IN TWO VERSIONS: VERSION A AND VERSION B. THE BOARD IS NOW AVAILABLE IN TWO VERSIONS: VERSION A AND VERSION B.

APPROVALS

DESIGNER: [Name]

DATE: [Date]

POWER BY LINEAR

48V/5A/VA Dual 25A POL Converter with Power System Management

DC2672A

REV: AD Customer Use Only

DATE: Tuesday, August 12, 2010

SHEET 1 OF 3

DEMO MANUAL DC2672A-A

SCHEMATIC DIAGRAM

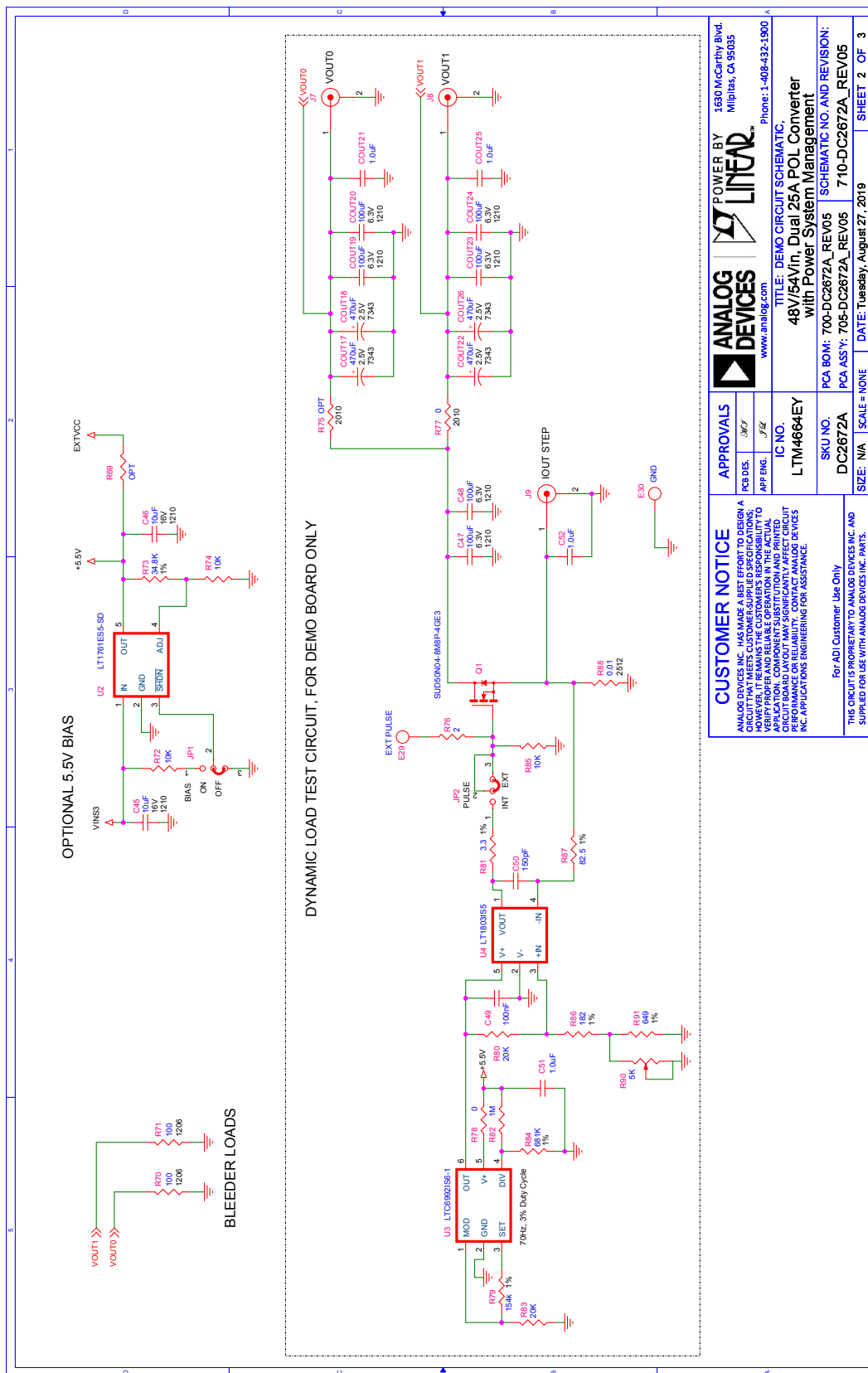

CUSTOMER NOTICE		APPROVALS	
ANALOG DEVICES HAS REVIEWED THIS CIRCUIT BOARD LAYOUT AND HAS NOTIFIED THE CUSTOMER OF ANY DESIGN ERRORS. HOWEVER, IT REMAINS THE CUSTOMER'S RESPONSIBILITY TO VERIFY PROPER AND RELIABLE OPERATION IN THE ACTUAL CIRCUIT BOARD LAYOUT. CONTACT ANALOG DEVICES INC. APPLICATIONS ENGINEERING FOR ASSISTANCE.		PCB DES. <i>3/07</i>	APP ENG. <i>J/07</i>
For ADI Customer Use Only		LTM4664EY	
THIS CIRCUIT IS PROPRIETARY TO ANALOG DEVICES INC. AND SUPPLIED FOR USE WITH ANALOG DEVICES INC. PARTS.		IC NO.	
		SKU NO.	
		DC2672A	
		PCA BOM: 705-DC2672A_REV05	
		SCHEMATIC NO. AND REVISION: 710-DC2672A_REV05	
		DATE: Tuesday, August 27, 2019	
		SCALE = NONE	
		SHEET 2 OF 3	

POWER BY 1630 McCarty Blvd.
Milpitas, CA 95035
ANALOG DEVICES
www.analog.com Phone: 1-408-432-1900
LINEAR

TITLE: DEMO CIRCUIT SCHEMATIC.
48V/54Vin, Dual 28A POL Converter
with Power System Management

SCHEMATIC DIAGRAM

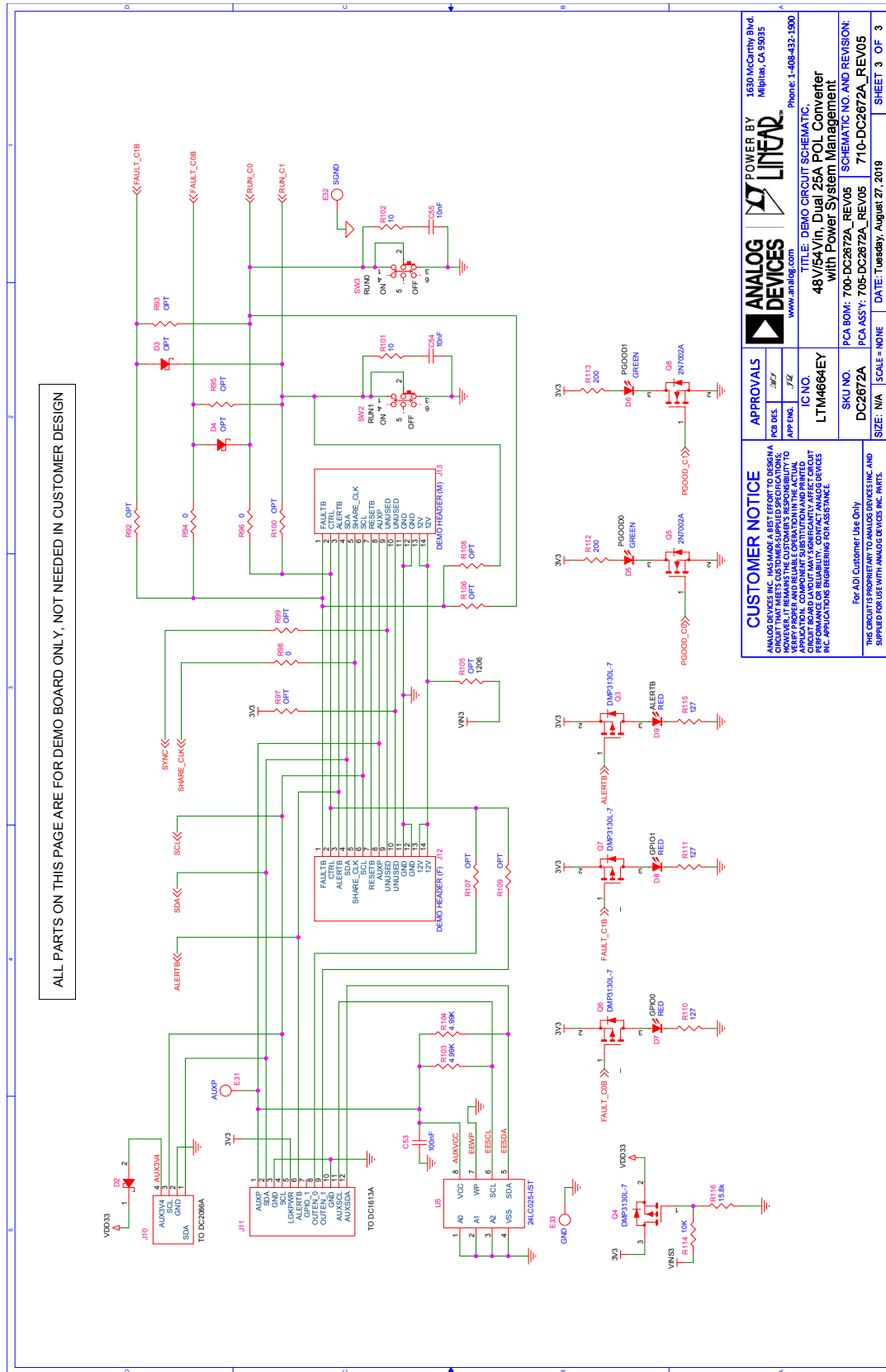

CUSTOMER NOTICE		APPROVALS	
<p>ANALOG DEVICES AND ITS REPRESENTATIVES ASSUME NO LIABILITY FOR ANY DAMAGE OR INJURY TO PERSONS OR PROPERTY THAT MAY BE CAUSED BY THE USE OF THE INFORMATION CONTAINED HEREIN. HOWEVER, IT REMAINS THE CUSTOMER'S RESPONSIBILITY TO DESIGN, BUILD, TEST, AND VERIFY THE CUSTOMER'S APPLICATION. COMPONENT SUBSTITUTION AND PRINTED CIRCUIT BOARD MANUFACTURING VARIATIONS MAY AFFECT PERFORMANCE OR RELIABILITY. CONTACT ANALOG DEVICES INC. APPLICATIONS ENGINEERING FOR ASSISTANCE.</p> <p>For ADI Customer Use Only THIS CIRCUIT IS PROPRIETARY TO ANALOG DEVICES INC. AND SUPPLIED FOR USE WITH ANALOG DEVICES INC. PARTS.</p>		<p>POWER BY ANALOG DEVICES www.analog.com</p> <p>1630 McCarthy Blvd. Milpitas, CA 95035 Phone: 1-408-432-1900</p>	<p>IC NO LTM4664EY</p> <p>SKU NO DC2672A</p> <p>DATE August 27, 2019</p>
<p>TITLE: DEMO CIRCUIT SCHEMATIC 48V/64Vin Dual 25A POL Converter with Power System Management</p> <p>PCA REV: 700-DC2672A_REV06 SCHEMATIC NO. AND REVISION: DC2672A 710-DC2672A_REV05</p>		<p>POE DES 3/07</p> <p>APP ENG JLW</p>	<p>SIZE: 1MA SCALE: NONE</p> <p>SHEET 3 OF 3</p>



ESD Caution

ESD (electrostatic discharge) sensitive device. Charged devices and circuit boards can discharge without detection. Although this product features patented or proprietary protection circuitry, damage may occur on devices subjected to high energy ESD. Therefore, proper ESD precautions should be taken to avoid performance degradation or loss of functionality.

Legal Terms and Conditions

By using the evaluation board discussed herein (together with any tools, components documentation or support materials, the "Evaluation Board"), you are agreeing to be bound by the terms and conditions set forth below ("Agreement") unless you have purchased the Evaluation Board, in which case the Analog Devices Standard Terms and Conditions of Sale shall govern. Do not use the Evaluation Board until you have read and agreed to the Agreement. Your use of the Evaluation Board shall signify your acceptance of the Agreement. This Agreement is made by and between you ("Customer") and Analog Devices, Inc. ("ADI"), with its principal place of business at One Technology Way, Norwood, MA 02062, USA. Subject to the terms and conditions of the Agreement, ADI hereby grants to Customer a free, limited, personal, temporary, non-exclusive, non-sublicensable, non-transferable license to use the Evaluation Board FOR EVALUATION PURPOSES ONLY. Customer understands and agrees that the Evaluation Board is provided for the sole and exclusive purpose referenced above, and agrees not to use the Evaluation Board for any other purpose. Furthermore, the license granted is expressly made subject to the following additional limitations: Customer shall not (i) rent, lease, display, sell, transfer, assign, sublicense, or distribute the Evaluation Board; and (ii) permit any Third Party to access the Evaluation Board. As used herein, the term "Third Party" includes any entity other than ADI, Customer, their employees, affiliates and in-house consultants. The Evaluation Board is NOT sold to Customer; all rights not expressly granted herein, including ownership of the Evaluation Board, are reserved by ADI. CONFIDENTIALITY. This Agreement and the Evaluation Board shall all be considered the confidential and proprietary information of ADI. Customer may not disclose or transfer any portion of the Evaluation Board to any other party for any reason. Upon discontinuation of use of the Evaluation Board or termination of this Agreement, Customer agrees to promptly return the Evaluation Board to ADI. ADDITIONAL RESTRICTIONS. Customer may not disassemble, decompile or reverse engineer chips on the Evaluation Board. Customer shall inform ADI of any occurred damages or any modifications or alterations it makes to the Evaluation Board, including but not limited to soldering or any other activity that affects the material content of the Evaluation Board. Modifications to the Evaluation Board must comply with applicable law, including but not limited to the RoHS Directive. TERMINATION. ADI may terminate this Agreement at any time upon giving written notice to Customer. Customer agrees to return to ADI the Evaluation Board at that time. LIMITATION OF LIABILITY. THE EVALUATION BOARD PROVIDED HEREUNDER IS PROVIDED "AS IS" AND ADI MAKES NO WARRANTIES OR REPRESENTATIONS OF ANY KIND WITH RESPECT TO IT. ADI SPECIFICALLY DISCLAIMS ANY REPRESENTATIONS, ENDORSEMENTS, GUARANTEES, OR WARRANTIES, EXPRESS OR IMPLIED, RELATED TO THE EVALUATION BOARD INCLUDING, BUT NOT LIMITED TO, THE IMPLIED WARRANTY OF MERCHANTABILITY, TITLE, FITNESS FOR A PARTICULAR PURPOSE OR NON-INFRINGEMENT OF INTELLECTUAL PROPERTY RIGHTS. IN NO EVENT WILL ADI AND ITS LICENSORS BE LIABLE FOR ANY INCIDENTAL, SPECIAL, INDIRECT, OR CONSEQUENTIAL DAMAGES RESULTING FROM CUSTOMER'S POSSESSION OR USE OF THE EVALUATION BOARD, INCLUDING BUT NOT LIMITED TO LOST PROFITS, DELAY COSTS, LABOR COSTS OR LOSS OF GOODWILL. ADI'S TOTAL LIABILITY FROM ANY AND ALL CAUSES SHALL BE LIMITED TO THE AMOUNT OF ONE HUNDRED US DOLLARS (\$100.00). EXPORT. Customer agrees that it will not directly or indirectly export the Evaluation Board to another country, and that it will comply with all applicable United States federal laws and regulations relating to exports. GOVERNING LAW. This Agreement shall be governed by and construed in accordance with the substantive laws of the Commonwealth of Massachusetts (excluding conflict of law rules). Any legal action regarding this Agreement will be heard in the state or federal courts having jurisdiction in Suffolk County, Massachusetts, and Customer hereby submits to the personal jurisdiction and venue of such courts. The United Nations Convention on Contracts for the International Sale of Goods shall not apply to this Agreement and is expressly disclaimed.