

A46

5MP Zoom Bullet with D/N, Adaptive IR, Extreme WDR, SLLS, 5x Zoom Lens



- 5 Megapixel
- Day & Night with Superior Low Light Sensitivity and Adaptive IR LED
- 5x Zoom Lens with f2.7-13.5/F1.4-F3.3, Auto focus (for installation)
- Extreme WDR
- H.265 Compression
- Wide Angle
- Event trigger, response and notification

► Specifications

Device

| | |
|----------------------------------|--|
| Product Type | Zoom Bullet |
| Maximum Resolution | 5MP |
| Application Environment | Outdoor |
| Image Sensor | Progressive Scan CMOS |
| Sensor Size | 1/2.8 " |
| Effective Pixels | 2592(H) X 1944(V) (5.04 MP) |
| Day / Night | Yes |
| Low Light Sensitivity | Superior |
| Minimum Illumination | Color: 0.018 lux (30 IRE); B/W: 0 lux (IR LED on) |
| Color to B/W Switch | ISP based switch, configurable |
| Mechanical IR Cut Filter | Yes |
| IR LED | Adaptive IR LED |
| IR Working Distance | 30m |
| Electronic Shutter | 1/5-1/64000 second (manual mode); 1/5-1/64000 second (auto mode) |
| Horizontal Resolution (TV Lines) | 1600 TVL |

Lens

| | |
|--------------------------|---------------------|
| Focal Length | Zoom, f2.7-13.5mm |
| Aperture | F1.4-F3.3 |
| Zoom Ratio | 5x optical zoom |
| Zoom Application | Camera Installation |
| Iris | Adaptive iris |
| Focus | Auto focus |
| Lens Mount | Board mount |
| Horizontal Viewing Angle | 96.8° - 30.7° |
| Vertical Viewing Angle | 70.4° - 23.1° |

Video

| | |
|-----------------------------------|---|
| Compression | H.265, H.264 (Main profile), MJPEG |
| Maximum Frame Rate vs. Resolution | 30 fps at 2560 x 1920 30 fps at 2048 x 1536 30 fps at 1920 x 1080 30 fps at 1280 x 960 30 fps at 1280 x 720 30 fps at 800 x 600 30 fps at 720 x 480 30 fps at 640 x 480 30 fps at 320 x 240 |
| Multi-Streaming | Simultaneous triple streams based on three configurations |
| Bit Rate Mode | Constant, Variable |
| Wide Dynamic Range | Extreme WDR (125 dB) |
| Image Enhancement | White Balance, Brightness, Backlight compensation (BLC), Contrast, Saturation, Sharpness, Automatic gain control, Flickerless, Digital Image Stabilizer (DIS, EIS), Defogging |
| Digital Noise Reduction | 2D + 3D DNR |
| Privacy Mask | 4 configurable regions |
| Text Overlay | Yes |
| On-Screen Graphics | Yes |
| Built-in Analytics | Tampering Detection |
| Server-based Analytics | Object Line Counting, People Counting, Face Detection, Object Based Motion Detection, Tamper, Object Line Crossing Detection, Object Enter Area Detection, Missing Object Detection, Unattended Object Detection, Smoke Detection, Heat Map, Dwell Time, Direction Detection, Automatic License Plate Recognition, (Require PC-based or standalone IVS or ALPR Server. Contact ACTi support for recommendations on how to maximize analytical accuracy) |
| Image Orientation | Flip, Mirror, Rotation (Corridor mode) |

Audio

| | |
|-------------------|----------------------------------|
| Audio Type | 2-way, Mic-in, Line-in, Line-out |
| Audio Compression | 8 kHz, Mono, G.711 |

Network

| | |
|----------------------------|---|
| Network Protocol & Service | IPv4/v6, TCP, UDP, DHCP, PPPoE, HTTP, HTTPS, DNS, DDNS, NTP, RTP, RTSP, RTCP, SMTP, FTP, IGMP, ICMP, ARP, Bonjour, UPnP, QoS, SNMP, IEEE 802.1X |
| Ethernet Port | 1 x Ethernet (10/100 Base-T), RJ-45 pigtail connector |

| | |
|----------|--|
| Security | IP address filtering, HTTPS encryption, Password protected user level, Anonymous login |
|----------|--|

Video Analytics

| | |
|----------------------|-------|
| Analysis Source Type | Video |
|----------------------|-------|

Event

| | |
|----------------|---|
| Event Trigger | Video motion detection (3 regions), External device through digital input, Sound detection, Tampering detection, Video streams loss |
| Event Response | Notify control center, Change camera settings, Command other devices, E-mail notification with snapshots, Play the audio file, Push notification to mobile device, Save video to local storage, Upload video to NVR server, Upload video or snapshot to FTP server, Activate external device through digital output |

System

| | |
|----------|---------|
| Watchdog | Support |
|----------|---------|

Integration

| | |
|-----------------------|--|
| Unified Solution | Fully compatible with ACTi software |
| Edge Recording | Support (integration with NVR by ONVIF Profile G or proprietary protocol)* |
| ONVIF Compliant | Yes, Profile S, Profile G, Profile T, Profile Q |
| Web Browser | IE 11 |
| Auto Firmware Upgrade | Yes |

Interface

| | |
|----------------------|--|
| Local Storage | MicroSDHC, MicroSDXC Memory Card Slot (card not included, up to 256GB, Kingston or Sandisk only) |
| Digital Input/Output | 1/1 (Cable with Terminal block), DC Output Voltage: 5V |
| Operating Button | Reset Button |

General

| | |
|-----------------------|--|
| Power Source | DC 12V, PoE Class 3 (IEEE802.3af) |
| Power Consumption | 12.95 W (PoE) |
| Weight | 1230.5g (2.71lb) |
| Dimensions | (W x H x D): 94mm x 86mm x 291.1mm (3.70" x 3.39" x 11.46") |
| Environmental Casing | Weatherproof (IP66), Vandal proof metal casing (IK10) |
| Mount Type | Integrated Bracket, Pole Mount |
| Starting Temperature | -20°C ~ 50°C (-4°F ~ 122°F) |
| Operating Temperature | -30°C ~ 50°C (-22°F ~ 122°F) |
| Approvals | CE, FCC, EAC, IP66, IK10 (metal casing) |
| Real-time Clock (RTC) | Yes |
| Warranty | 3 Year(s). For extended warranty offering, see http://www.acti.com/support/warranty |

* Edge Recording function is integrated with NVR 3 Corporate / NVR 3 Business / INR / GNR series.

► Photo Indication



- ① Audio Output
- ② DC 12V Power Input
- ③ Factory Reset
- ④ Audio Input
- ⑤ Ethernet Port
- ⑥ Digital Input / Output

► Dimension Diagram

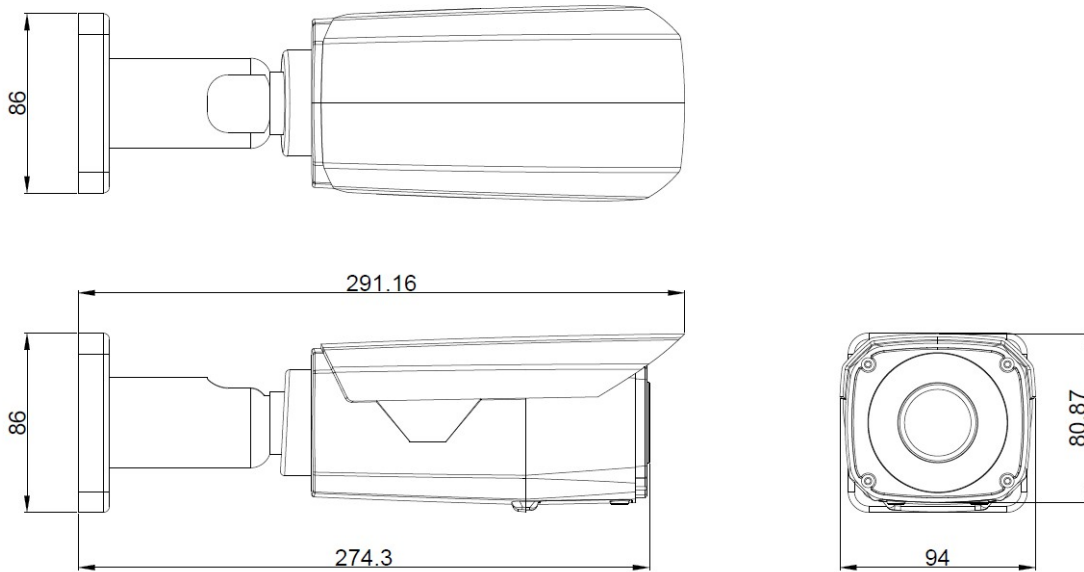





Unit: mm [inch]

▶ Related Products

Bullet - Bullet



| | | |
|------|---|--|
| E43B |  | 5MP Bullet with D/N, Adaptive IR, Basic WDR, Vari-focal lens, f2.8-12mm/F1.4 (HOV:69.2°-28.2°), H.264, 1080p/30fps, DNR, Audio, MicroSDHC/MicroSDXC, PoE, IP68, IK10 (metal casing), DI/DO |
|------|---|--|

Mounting Accessories - Camera Mount

| | | |
|-----------|---|---|
| PMAX-0512 |  | Pole Mount (for E39, PMAX-0706), supports 3.25" to 7.0" Poles |
| PMAX-0517 |  | Pole Mount (for A44, A45, A46, A48, A413), supports 3.25" to 7.0" Poles |
| PMAX-0518 |  | Pole Mount (for A44, A45, A46, A48, A413), supports 2" to 3" Poles |
| PMAX-0524 |  | Pole Mount (for A416, A418, ,A419, A44, A45, A46, A48, VMGB-351, B419-P2), supports 2.64" to 5" Poles |
| PMAX-0706 |  | Junction Box (for A3x, A4x, E39, E41x, PMAX-0805) |

Note: Some mounting accessories may need additional accessories for installation. Please check www.acti.com/mountingselector for more information.



Power Supply Accessories - Power Adapter

| | | |
|-----------|---|---|
| PPBX-0012 |  | Power Adapter AC 100~240V (US), for A3x, A4x, A88, A9x, Z31, Z8x, Z9x |
| PPBX-0013 |  | Power Adapter AC 100~240V (EU), for A3x, A4x, A88, A9x, Z31, Z8x, Z9x |
| PPBX-0014 |  | Power Adapter AC 100~240V (UK), for A3x, A4x, A88, A9x, Z31, Z8x, Z9x |

Power Supply Accessories - PoE Injector

| | | |
|-----------|---|---|
| PPOE-0002 |  | PoE Injector IEEE 802.3af compliant, AC 100~240V, with universal connectors |
|-----------|---|---|

Audio Devices - Microphone

| | | |
|-----------|---|---|
| PMIC-0100 |  | Active Microphone Omnidirectional for all Cameras with Line-in Audio |
| PMIC-0200 |  | Passive Microphone Omnidirectional for all Cameras with Mic-in Audio using 3.5mm Phone Jack |