

EMC/EMI Filter for PV Inverters

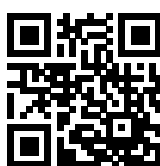

- Reduces conducted emissions towards the solar panel
- Reduces the probability of EMI radiation off the solar panel
- Helps to prevent pre-mature panel aging because of HF leakage currents
- Helps to meet international EMC regulations for the entire PV system
- Most compact standard solution in the industry, optionally available without capacitors to ground (B types)
- New: up to 2300 A



Performance indicators

Attenuation performance



Rated current [A]



Approvals & Compliances



(cURus:600 VDC) (ENEC14: 600 VDC)

FN2200 are very compact DC filters for PV inverters and therefore support the integration in shrinking frame sizes of power electronics. All FN2200 come in unsymmetrical housings, which help to prevent inverse installation and wrong electrical connection. Along with grid-side installed AC EMC/EMI filters, FN2200 are key to meet the international EMC standards like EN 61000-6-3 and -6-4 and help to ensure reliable operation of the system. FN2200 are designed for very low power loss, to support overall efficiency.

Features and Benefits

Installed between the PV inverter and the solar panel, FN2200 DC filters help to control conducted emissions on the panel side of the system and therefore reduce the potential for interference radiation off the panel. The filter also protects the solar panel from HF stray and leakage currents which can cause pre-mature aging in the PV modules.

Typical Applications

FN 2200 are primarily designed for PV inverters. However, they can potentially also be used in other DC applications within published specifications, like UPS, DC motor drives, or DC quick chargers.







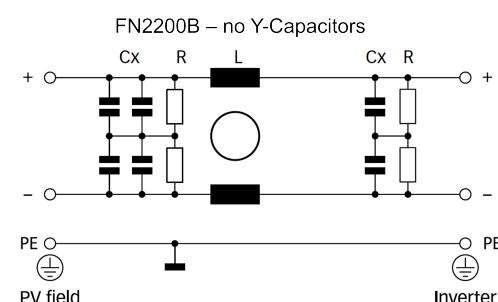
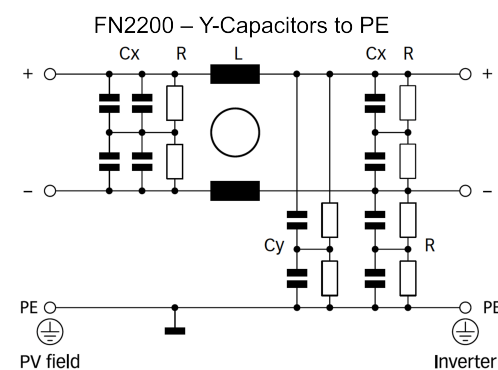



















Technical Specifications

Maximum continuous operating voltage	Max. 1200 VDC
Operating frequency	DC
Rated currents	25 to 2300 A @ 55°C
High potential test voltage	P → E 3600 VDC for 2 sec P → P 3000 VDC for 2 sec
Protection category	IP 20 (25 to 150 A types) IP 00 (250 to 2300 A types)
Overload capability	4x rated current at switch on, 1.5x rated current for 1 minute, once per hour
Temperature range (operation and storage)	-40°C to +100°C (40/100/21)
Design corresponding to	UL 1283, CSA 22.2 No. 8 1986, IEC/EN 60939
Flammability corresponding to	UL 94 V-2 or better

Typical electrical schematic



Filter Selection Table

Filter	Buy	Rated current	Typical inverter	Filter efficiency	Power loss	Input/Output connections		Weight
		@ 55°C (40°C)	AC power rating*	@ 25°C/DC	@ 25°C/DC			[kg]
		[A]	[kW]	[%]	[W]			
FN2200-25-33		25 (28)	10	> 99.9	8	-33		0.9
FN2200-50-34		50 (57)	20	> 99.9	17	-34		1.6
FN2200-75-34		75 (86)	30	> 99.9	18	-34		1.7
FN2200-100-35		100 (115)	40	> 99.9	22	-35		2.7
FN2200-150-40		150 (173)	60	> 99.9	31	-40		4.9
FN2200-250-99		250 (288)	100	> 99.9	10		-99	5.0
FN2200-400-99		400 (460)	150	> 99.9	16		-99	6.1
FN2200-600-99		600 (690)	250	> 99.9	29		-99	6.5
FN2200-800-99		800 (920)	350	> 99.9	26		-99	9.3
FN2200-1000-99		1000 (1150)	400	> 99.9	40		-99	9.4
FN2200-1500-99		1500 (1600)	500	> 99.9	45		-99	14.6
FN2200-2300-99		2300 (2500)	800/1000	> 99.9	84		-99	25.0
FN2200B-25-33		25 (28)	10	> 99.9	8	-33		0.9
FN2200B-50-34		50 (57)	20	> 99.9	17	-34		1.6
FN2200B-75-34		75 (86)	30	> 99.9	18	-34		1.7
FN2200B-100-35		100 (115)	40	> 99.9	22	-35		2.7
FN2200B-150-40		150 (173)	60	> 99.9	31	-40		4.9
FN2200B-250-99		250 (288)	100	> 99.9	10		-99	5.0
FN2200B-400-99		400 (460)	150	> 99.9	16		-99	6.1
FN2200B-600-99		600 (690)	250	> 99.9	29		-99	6.5
FN2200B-800-99		800 (920)	350	> 99.9	26		-99	9.3
FN2200B-1000-99		1000 (1150)	400	> 99.9	40		-99	9.4
FN2200B-1500-99		1500 (1600)	500	> 99.9	45		-99	14.6
FN2200B-2300-99		2300 (2500)	800/1000	> 99.9	84		-99	25.0

* Based on rated DC current of typical 3-phase PV inverters with 900 VDC input. Note: depending upon manufacturer and model, DC currents for a given PV inverter power can differ significantly. Filters with higher current ratings for large central inverters up to the MW range are available upon request.

Distribution Inventory

Up-to-date inventory levels for global distributors is available at <https://products.schaffner.com/stock>



Typical Filter Attenuation

Per CISPR 17; A=50 Ω/50 Ω sym; B=50 Ω/50 Ω asym; C=0.1 Ω/100 Ω sym; D=100 Ω/0.1 Ω sym

25 to 75 A types

100 to 150 A types

250 A types

400 to 2300 A types

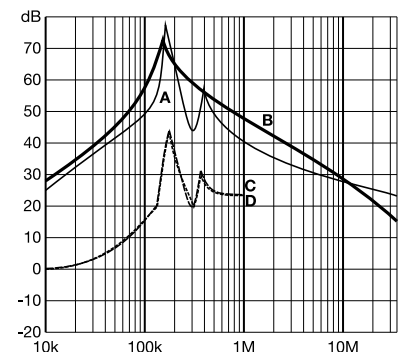
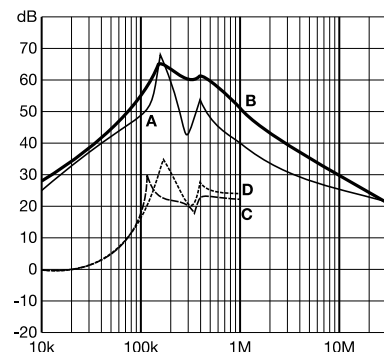
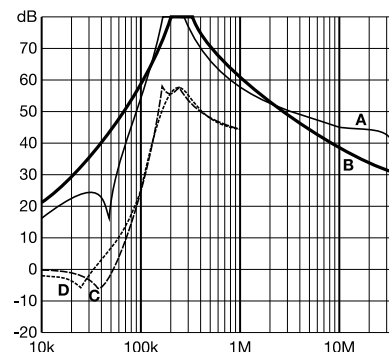
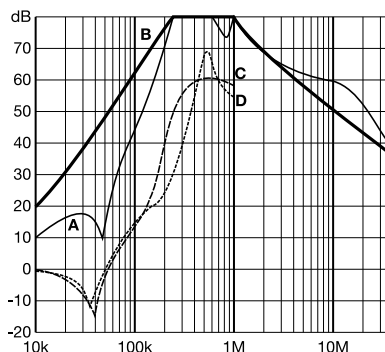

Typical Block Schematic

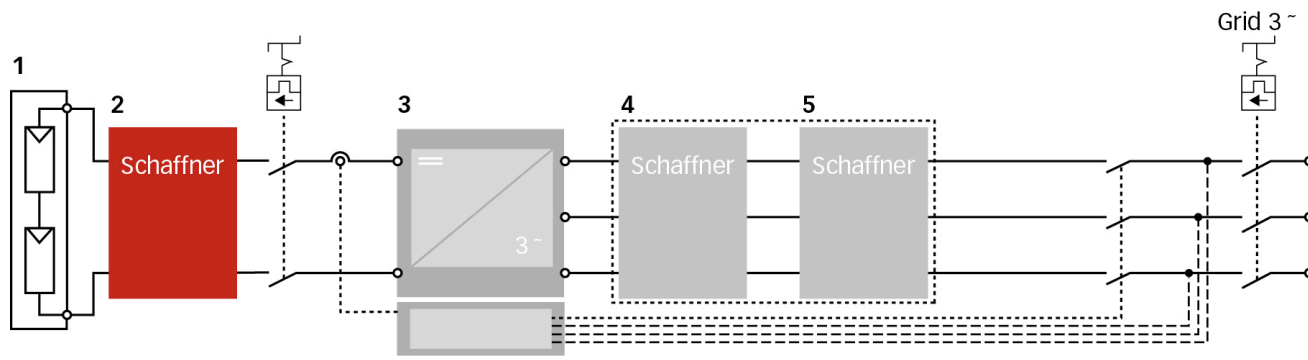

1 PV modules
2 Schaffner FN 2200

3 Central Inverter
4 Schaffner magnetic components

5 Schaffner AC EMC/EMI filter

Mechanical Data

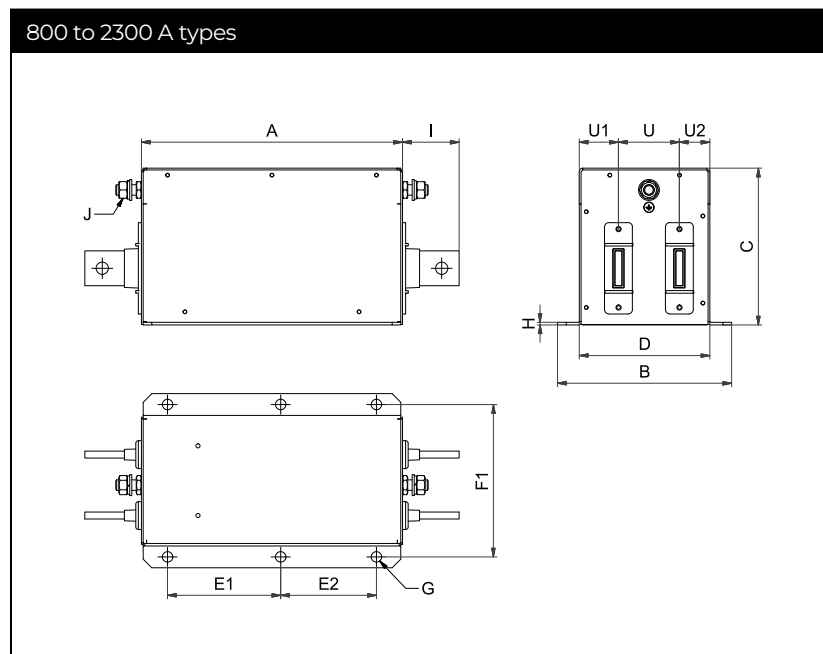
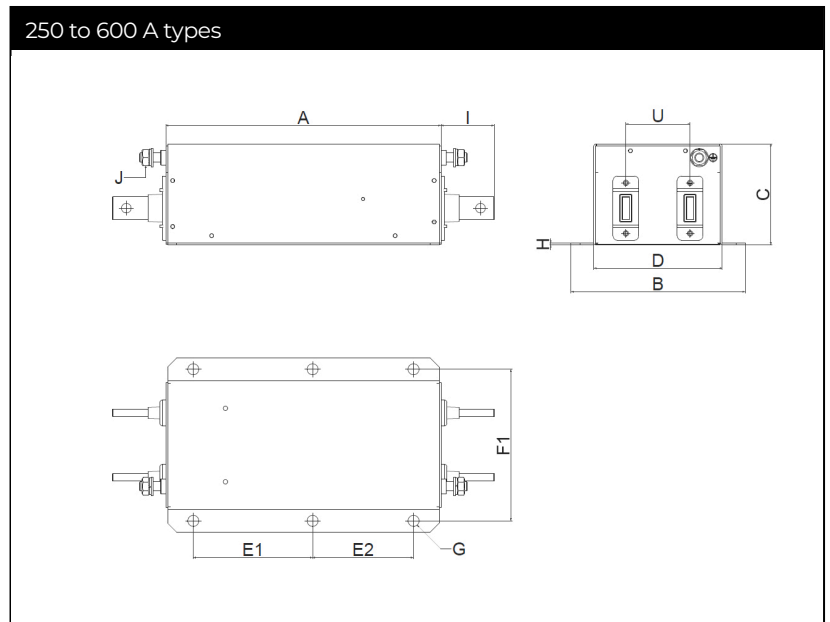

Note: all FN 2200 provide unsymmetrical mounting hole patterns to prevent inverse filter installation in the field. (Dimensions E1 E2 and F1/F2)

Busbar Connections

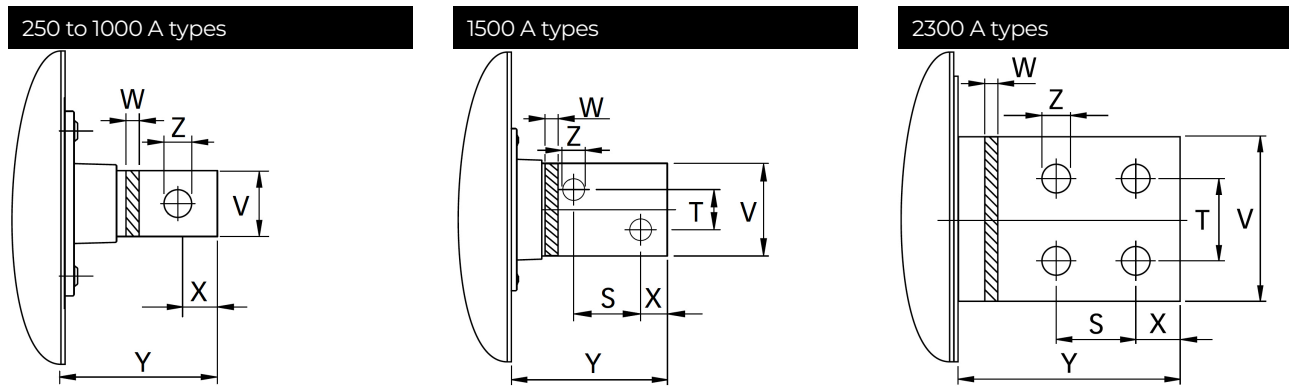

Dimensions

	25 A	50 A	75 A	100 A	150 A	250 A	400 A	600 A	800 A	1000 A	1500 A	2300 A
A	170	200	200	220	250	300	300	300	300	300	300	400
B	80	95	95	125	140	180	190	190	200	200	200	250
C	65	80	80	95	115	110	110	110	140	140	150	180
D	140	170	170	190	220	130	140	140	150	150	150	195
E1	152.5	182.5	182.5	202.5	232.5	130	130	130	130	130	130	190
E2						110	110	110	110	110	110	150
F1	45	60	60	80	100	155	165	165	175	175	175	225
F2	60	75	75	100	120							
G	5.5	5.5	5.5	5.5	5.5	∅ 12	∅ 12	∅ 12	∅ 12	∅ 12	∅ 12	∅ 12
H	1	1.5	1.5	1.5	2	2	2	2	3	3	3	3
I	25	39	39	45	51	58	58	58	65	65	110	100
J	M5	M6	M6	M8	M10	M10	M10	M10	M12	M12	M12	M16
S											43	35
T											26	35
U						70	70	70	70	70	70	100
U1									45	45	55	61
U2									35	35	25	34
V						20	25	25	40	40	60	70
W						5	6	8	8	8	10	15
X						15	15	15	20	20	17	20
Y						58	58	58	65	65	110	100
Z						∅ 9	∅ 10.5	∅ 10.5	∅ 14	∅ 14	∅ 14	∅ 14

All dimensions in mm; 1 inch = 25.4 mm

Tolerances according: ISO 2768-m/EN 22768-m

Filter Input/Output Connector Cross Sections

	-33	-34	-35	-40
Solid wire	16 mm ²	35 mm ²	50 mm ²	95 mm ²
Flex wire	10 mm ²	25 mm ²	50 mm ²	95 mm ²
AWG type wire	AWG 6	AWG 2	AWG 1/0	AWG 4/0
Recommended torque	1.5-1.8 NM	4.0-4.5 NM	7-8 NM	17-20 NM

Please visit www.schaffner.com to find more details on filter connectors.

Headquarters, Global Innovation and Development

Switzerland

Schaffner Group

Industrie Nord
Nordstrasse 11e
4542
Luterbach
+41 32 681 66 26
info@schaffner.com

Sales and Application Centers

China

Schaffner EMC Ltd. Shanghai

T20-3 C No 565 Chuangye Road Pudong district
201201
Shanghai
+86 2138139500
cschina@schaffner.com

Sweden

Schaffner EMC AB

Östermalmstrorg 1
114 42
Stockholm
+46 8 5050 2425
swedensales@schaffner.com

Switzerland

Schaffner EMV AG

Industrie Nord
Nordstrasse 11e
4542
Luterbach
+41 32 681 66 26
switzerlandsales@schaffner.com

Taiwan

Schaffner EMV Ltd.

U-Town
20 Floor-2 No 97 Section 1 XinTai 5th Road
XiZhi District
22175
New Taipei City
+886 226975500
taiwansales@schaffner.com

Thailand

Schaffner EMC Co. Ltd.

Sathorn Square Tower
Room 3780 37FL 98 North-Sathorn Rd Silom
Bangrak
10500
Bangkok
+66 621056397
thailandsales@schaffner.com

United Kingdom

Schaffner Ltd.

Suite 1 Oakmede Place
Terrace Road
RG42 4JF
Binfield
+44 118 9770070
uksales@schaffner.com

United States

Schaffner EMC Inc.

52 Mayfield Avenue
Edison, New Jersey
+1 732 225 9533
usasales@schaffner.com

Finland

Schaffner Oy

Sauvonrinne 19 H
8500
Lohja
+358 50 468 7284
finlandsales@schaffner.com

France

Schaffner EMC S.A.S.

16-20 Rue Louis Rameau
95875
Bezons
+33 1 34 34 30 60
francesales@schaffner.com

Germany

Schaffner Deutschland GmbH

Schoemperlenstrasse 12B
76185
Karlsruhe
+49 721 56910
germanysales@schaffner.com

India

Schaffner India Pvt. Ltd

Regus World Trade Centre
WTC 22nd Floor Unit No 2238 Brigade
Gateway Campus 26/1 Dr. Rajkumar Road
Malleswaram (W)
560055
Bangalore
+91 8067935355
indiasales@schaffner.com

Italy

Schaffner EMC S.r.l.

Via Ticino, 30
20900
Monza (MB)
+39 039 21 41 070
italysales@schaffner.com

Japan

Schaffner EMC K.K.

ISM Sangenjaya 7F
1-32-12 Kamiyama Setagaya-ku
154-0011
Tokyo
+81 3 5712 3650
japansales@schaffner.com

Singapore

Schaffner EMC Pte Ltd.

Blk 3015A Ubi Road 1 #05-09 Kampong Ubi
Industrial Estate
408705
Singapore
+65 63773283
singaporesales@schaffner.com

To find your local partner within Schaffner's global network schaffner.com

© 2023 Schaffner Group

The content of this document has been carefully checked and understood. However, neither Schaffner nor its subsidiaries assume any liability whatsoever for any errors or inaccuracies of this document and the consequences thereof. Published specifications are subject to change without notice. Product suitability for any area of application must ultimately be determined by the customer. In all cases, products must never be operated outside their published specifications. Schaffner does not guarantee the availability of all published products. This disclaimer shall be governed by substantive Swiss law and resulting disputes shall be settled by the courts at the place of business of Schaffner Holding AG. Latest publications and a complete disclaimer can be downloaded from the Schaffner website. All trademarks recognized.