

Automotive LED Driver with Integrated Hall-Effect Switch

FEATURES AND BENEFITS

- Linear LED drive current ≤ 150 mA set by an external reference resistor
- High sensitivity, omnipolar Hall-effect switch for LED on/off control
- Low component count for small size and ease of design
- Elegant fade-in/fade-out effects with adjustable duration (optional)
- Qualified per AEC-Q100 for automotive applications
- Low dropout voltage and low supply current
- Chopper-stabilized Hall switch
 - Low switch point drift over temperature
 - Insensitivity to physical stress
- Input pin for external LED driver control
- Slew-rate-limited LED output drive for current transient suppression
- Ruggedness and reliability
 - Integrated voltage regulator for operation from 7 to 24 V
 - Reverse-battery protection
 - Automatic short-circuit and thermal overload protection and recovery
 - -40°C to 125°C ambient temperature range
- Small 8-pin SOIC package with thermal pad

PACKAGE: 8-Pin SOICN with Exposed Thermal Pad (Suffix LJ)

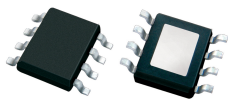

Not to scale

DESCRIPTION

The A1569K is a highly integrated solution that combines a Hall-effect switch with a linear, programmable current regulator, providing up to 150 mA to drive one or more LEDs. With the addition of only two passive components and one or more LEDs, the A1569K forms a complete, magnetically actuated lighting solution that is small, flexible, elegant, easy to design, rugged, and reliable. It is optimized for automotive interior and auxiliary lighting such as map lights, glove boxes, consoles, vanity mirrors, hood/truck/bed lights, etc.

The LED drive current is set by an external resistor; the LED is then activated by the built-in Hall-effect switch and features an adjustable fade-in/fade-out effect. Omnipolar operation (either north or south pole) and high magnetic sensitivity make the A1569K tolerant of large air gaps and mechanical misalignment. System assembly is easier, as the magnet can be oriented with either pole facing the device. Chopper stabilization provides low switch point drift over the operating temperature range. The driver can also be activated via an external input for direct control of the LED.

In addition to contactless operation and safe, constant-current LED drive, reliability is further enhanced with reverse-battery protection, thermal foldback, and automatic shutdown for thermal overload and shorts to ground. The A1569K will prevent damage to the system by removing LED drive current until the short is removed and/or the chip temperature has reduced below the thermal threshold. The driver output is slew-rate-limited to reduce electrical noise during operation.

Continued on the next page...

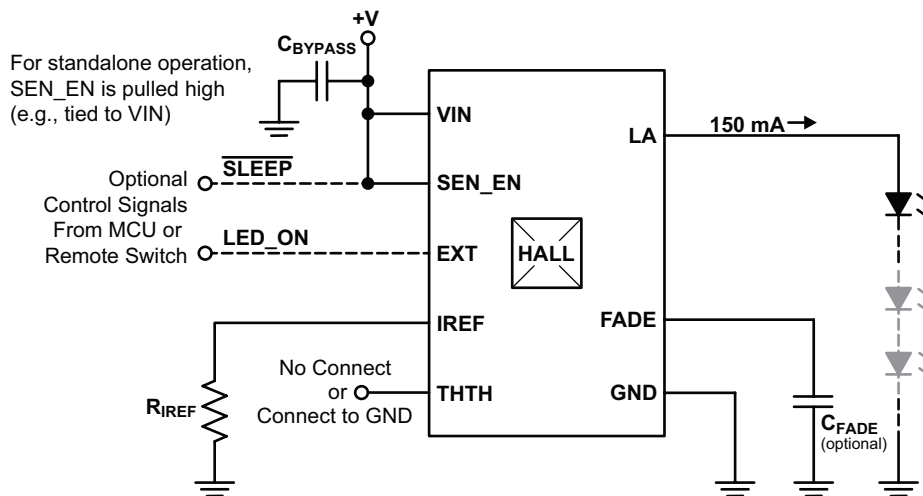

Typical Application Diagram

A1569K

Automotive LED Driver with Integrated Hall-Effect Switch

DESCRIPTION (continued)

The device is packaged in an 8-pin SOICN (LJ) with an exposed pad for enhanced thermal dissipation. It is RoHS compliant, with 100% matte-tin leadframe plating.

The A1569K is intended for automotive applications that require extremely wide operating temperature ranges (up to 125°C) and qualification per AEC-Q100. For other applications, refer to the A1569E.

SELECTION GUIDE*

Part Number	Packing	Package	Temperature Range, T _A (°C)
A1569KLJTR-T	3000 pieces per 13-in. reel	8-pin SOICN surface mount	-40 to 125

* For non-automotive applications, see A1569E datasheet.



SPECIFICATIONS

ABSOLUTE MAXIMUM RATINGS

Characteristic	Symbol	Notes	Rating	Unit
Forward Supply Voltage	V _{IN} (V _{DD})		30	V
Reverse Supply Voltage	V _{RDD}		-18	V
Pin SEN_EN	V _{SEN_EN}		-18 to 30	V
Pin LA	V _{LA}		-0.3 to 30	V
Pin EXT	V _{EXT}		-0.3 to 6.5	V
Pin IREF	V _{IREF}		-0.3 to 6.5	V
Pin THTH	V _{THTH}		-0.3 to 6.5	V
Pin FADE	V _{FADE}		-0.3 to 6.5	V
Operating Ambient Temperature	T _A	Range K	-40 to 125	°C
Maximum Junction Temperature	T _{J(MAX)}		165	°C
Storage Temperature	T _{stg}		-65 to 170	°C

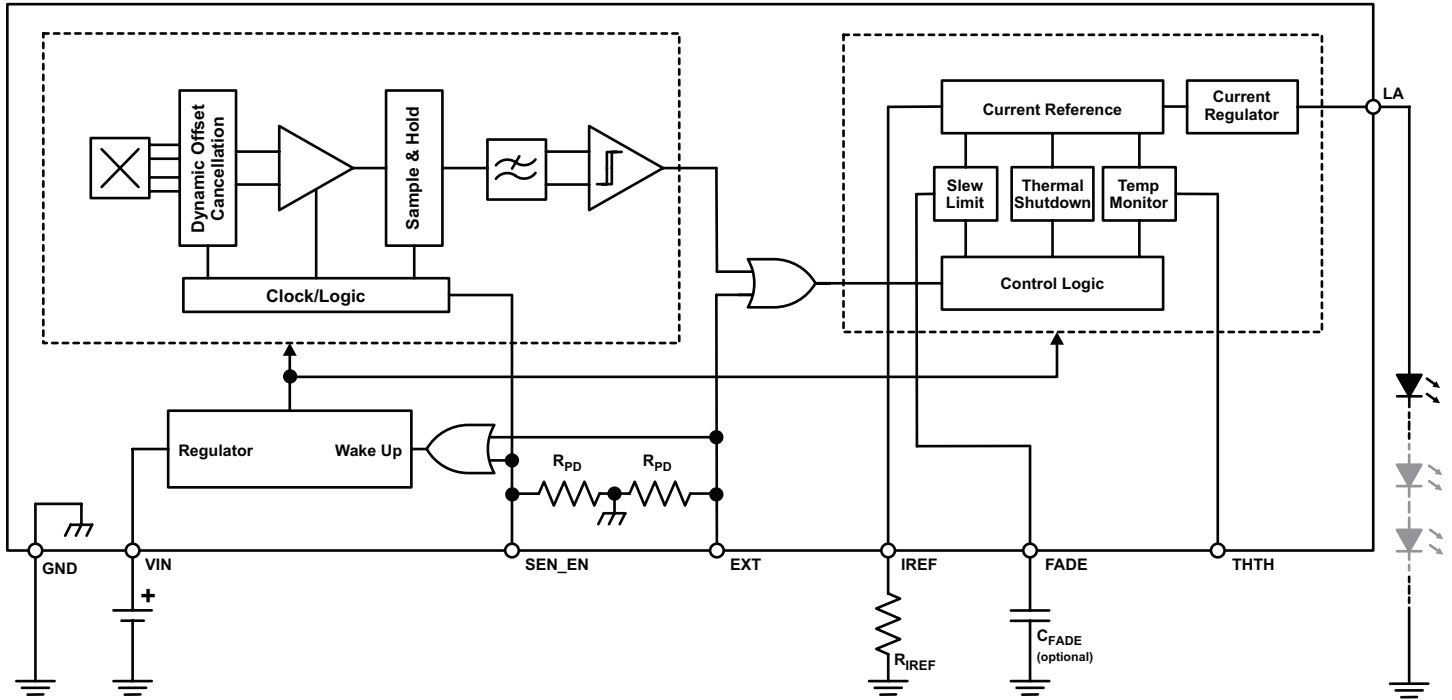

Functional Block Diagram

Pinout Drawing and Terminal List

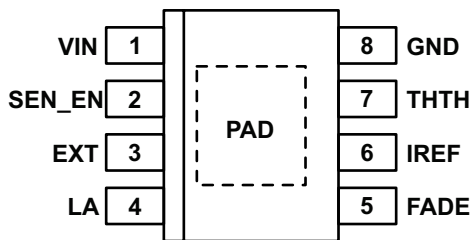

Package LJ, 8-Pin SOICN Pinout Drawing

Terminal List

Pin Number	Pin Name	Description
1	VIN	Supply
2	SEN_EN	Hall sensor enable
3	EXT	External override input
4	LA	LED anode (+) connection
5	FADE	Fade-in/fade-out dimming
6	IREF	Current reference
7	THTH	Thermal threshold
8	GND	Ground reference
-	PAD	Exposed thermal pad (may be left floating or tied to ground)

ELECTRICAL CHARACTERISTICS: Valid at $T_A = -40^\circ\text{C}$ to 125°C , $V_{IN} = 7$ to 24 V (unless otherwise specified)

Characteristic	Symbol	Test Conditions	Min.	Typ. [1]	Max.	Units
ELECTRICAL CHARACTERISTICS						
V_{IN} Functional Operating Range	V_{IN} (V_{DD})	Operating, $T_J < 165^\circ\text{C}$	7	–	24	V
V_{IN} Quiescent Current	I_{INQ}	LA connected to V_{IN} , LED off	–	6	10	mA
V_{IN} Sleep Current	I_{INS}	SEN_EN and EXT = GND	–	10	25	μA
Startup Time	t_{ON}	SEN_EN = V_{IN} , $ B < B_{RPx} - 5$ gauss, $R_{IREF} = 600 \Omega$, $C_{FADE} = 100$ pF, measured from $V_{IN} > 7$ V to I_{LA} source $> 90\%$ I_{LAmax}	–	–	1	ms
External Response Time	t_{EXT}	SEN_EN = GND, $V_{IN} > 7$ V $R_{IREF} = 600 \Omega$, $C_{FADE} = 100$ pF, measured from EXT $> V_{IH(MIN)}$ to I_{LA} source $> 5\%$ I_{LAmax}	–	–	1	ms
CURRENT REGULATION						
Reference Voltage	V_{IREF}	$267 \mu\text{A} < I_{REF} < 2$ mA	–	1.2	–	V
Reference Current Ratio	G_H	$(I_{LA} + 0.5) / I_{REF}$	–	75	–	–
Current Accuracy [2]	E_{ILA}	$20 \text{ mA} > I_{LA} > 150$ mA	–5	± 4	5	%
Output Source Current	I_{LA}	SEN_EN = high, $B_{FIELD} < B_{RP}$	–	$G_H \times I_{REF}$	–	–
		$R_{IREF} = 600 \Omega$, SEN_EN = high and $B_{FIELD} < B_{RP}$, or EXT = high	–	150	170	mA
Dropout Voltage	V_{DO}	$V_{IN} - V_{LA}$, $I_{LA} = 150$ mA	–	–	2.4	V
		$V_{IN} - V_{LA}$, $I_{LA} = 50$ mA	–	800	–	mV
Current Slew Time	$t_{FADE(MIN)}$	Current rising or falling between 10% and 90%, $C_{FADE} = 100$ pF	–	80	–	μs
LOGIC INPUTS						
Input Low Voltage	V_{IL}	SEN_EN, EXT	–	–	0.8	V
Input High Voltage	V_{IH}	SEN_EN, EXT	2	–	–	V
Pull-Down Resistor	R_{PD}	SEN_EN, EXT	–	50	–	k Ω
Input Voltage Range	V_{LOGIC}	EXT, IREF, THTH, FADE	–0.3	–	5.5	V
		SEN_EN	–0.3	–	24	V

Continued on next page...

[1] Typical data is at $T_A = 25^\circ\text{C}$ and $V_{IN} = 12$ V and it is for design information only.

[2] When SEN_EN or EXT = high, $E_{ILA} = 100 \times \{[(|I_{LA}| + 0.5) \times R_{IREF} / 90] - 1\}$, with I_{LA} in mA and R_{IREF} in k Ω .

ELECTRICAL CHARACTERISTICS (continued): Valid at $T_A = -40^\circ\text{C}$ to 125°C , $V_{IN} = 7$ to 24 V (unless otherwise specified)

Characteristic	Symbol	Test Conditions	Min.	Typ. [1]	Max.	Units
PROTECTION						
Short Detect Voltage	V_{SCD}	Measured at LA	1.2	–	1.8	V
Short-Circuit Source Current	I_{SCS}	Short present LA to GND	–	1	–	mA
Short Release Voltage Hysteresis	V_{Schys}	$V_{SCR} - V_{SCD}$, measured with $0.1\ \mu\text{F}$ capacitor between ILA and GN	200	–	500	mV
Thermal Monitor Activation ²	T_{JM}	T_J with $I_{SEN} = 90\%$, THTH open	110	130	145	$^\circ\text{C}$
Thermal Monitor Slope ²	dI_{SEN}/dT_J	$I_{SEN} = 50\%$, THTH open	–3.5	–2.5	–1.5	$\%/^\circ\text{C}$
Thermal Monitor Low Current Temperature	T_{JL}	T_J at $I_{SEN} = 25\%$, THTH open	135	150	165	$^\circ\text{C}$
Overtemperature Shutdown	T_{JF}	Temperature increasing	–	170	–	$^\circ\text{C}$
Overtemperature Hysteresis	T_{Jhys}	Recovery occurs at $T_{JF} - T_{Jhys}$	–	15	–	$^\circ\text{C}$
MAGNETIC CHARACTERISTICS [3]						
Operate Point	B_{OPS}	SEN_EN = high and $B_{FIELD} > B_{OP}$, LED is off (EXT = low)	–	40	70	G
	B_{OPN}		–70	–40	–	G
Release Point	B_{RPS}	SEN_EN = high and $B_{FIELD} < B_{RP}$, LED is on (EXT = low)	5	25	–	G
	B_{RPN}		–	–25	–5	G
Hysteresis	B_{HYS}	$ B_{OPX} - B_{RPX} $	5	15	25	G

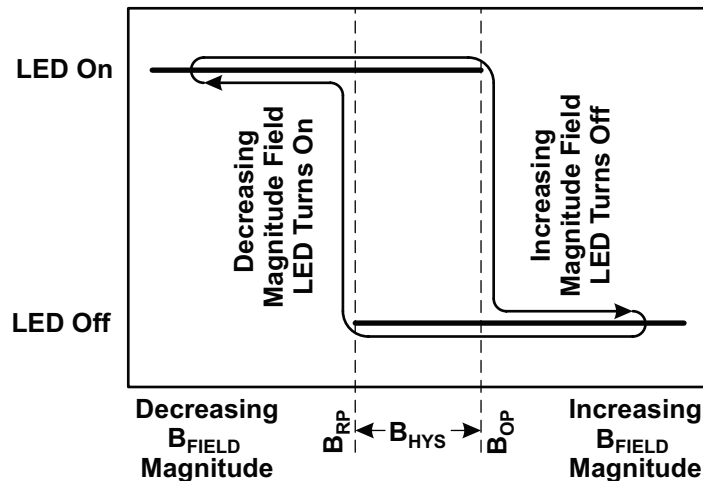

Figure 1: Hall Switch Control of LED State

[1] Typical data is at $T_A = 25^\circ\text{C}$ and $V_{IN} = 12\text{ V}$; for design information only.

[2] Guaranteed by design.

[3] Magnetic flux density, B, is indicated as a negative value for north-polarity magnetic fields, and is a positive value for south-polarity magnetic fields.

THERMAL CHARACTERISTICS

Characteristic	Symbol	Test Conditions	Min.	Typ.	Max.	Units
Thermal Resistance (Junction to Ambient)	$R_{\theta JA}$ (High-K)	JEDEC Package MS-012 BA. Test is performed using a high thermal conductivity, multilayer printed circuit board that closely approximates those specified in the JEDEC standards JESD51-7. Thermal vias are included per JESD51-5.	–	35	–	°C/W
	$R_{\theta JA}$ (Usual-K)	JEDEC Package MS-012 BA. Multiple measurement points on both single- and dual-layer printed circuit boards with minimal exposed copper (2-oz) area. See Figure 2 for more detail.	–	62-147	–	°C/W

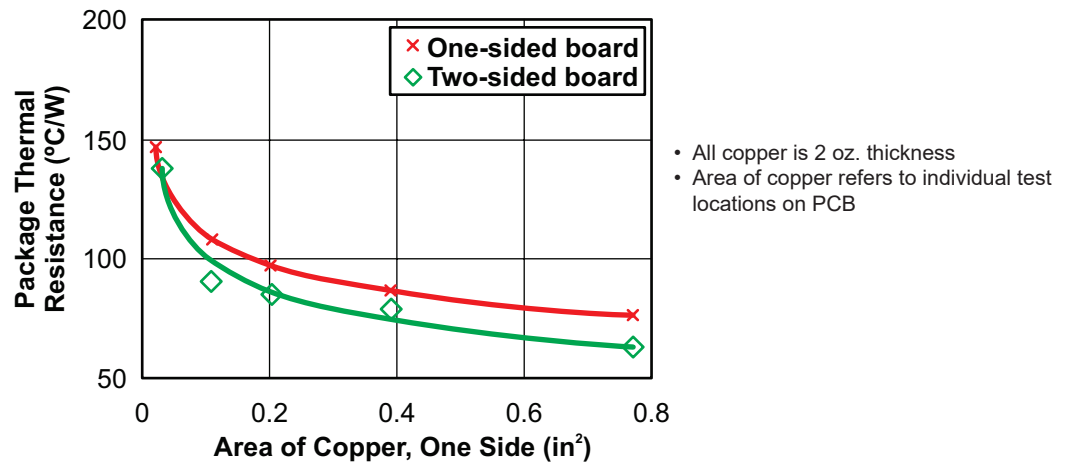
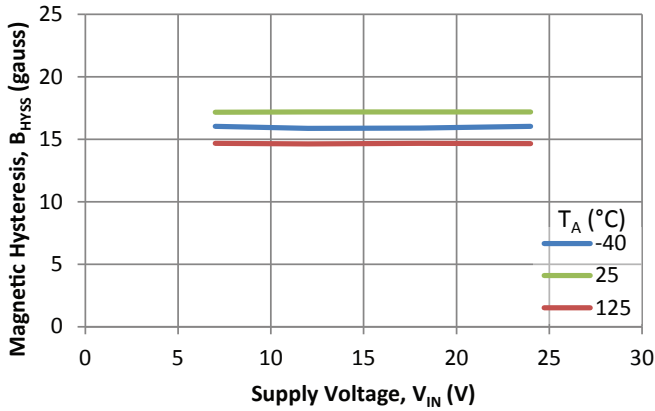

Figure 2: Thermal Resistance ($R_{\theta JA}$) versus Copper Area on Printed Circuit Board (PCB)

CHARACTERISTIC PERFORMANCE

B_{HYSS} vs. V_{IN}



B_{HYSS} vs. T_A

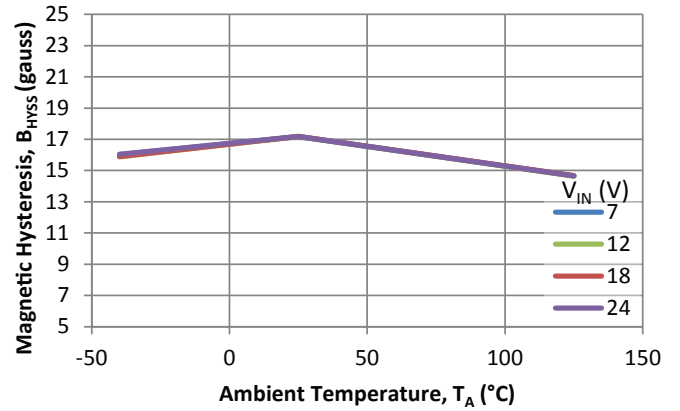

B_{OPS} vs. V_{IN}

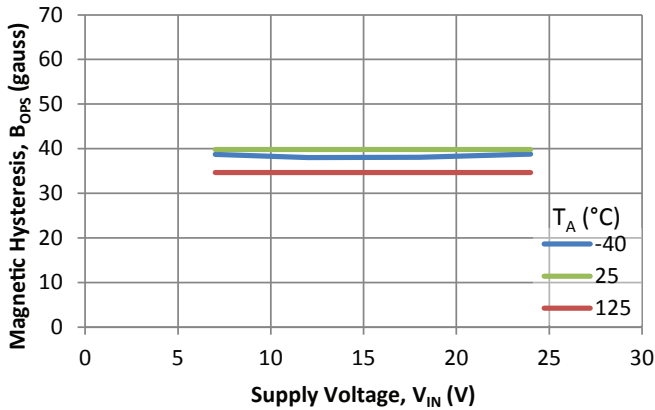

B_{OPS} vs. T_A

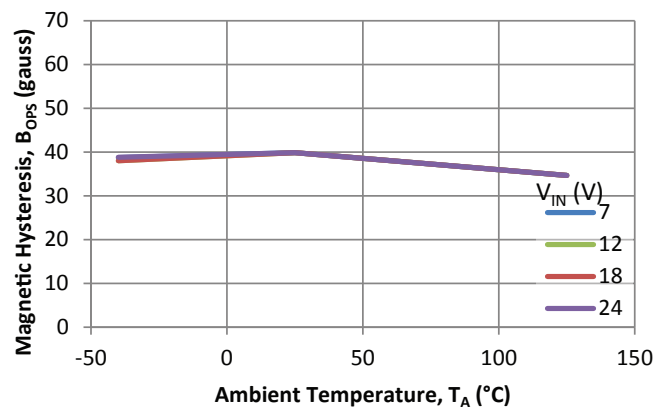

B_{RPS} vs. V_{IN}

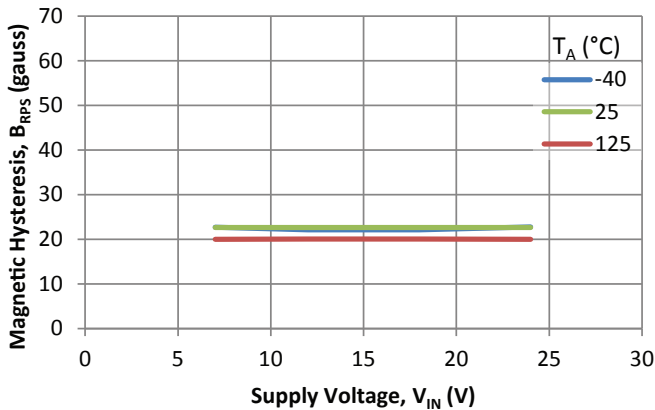

B_{RPS} vs. T_A

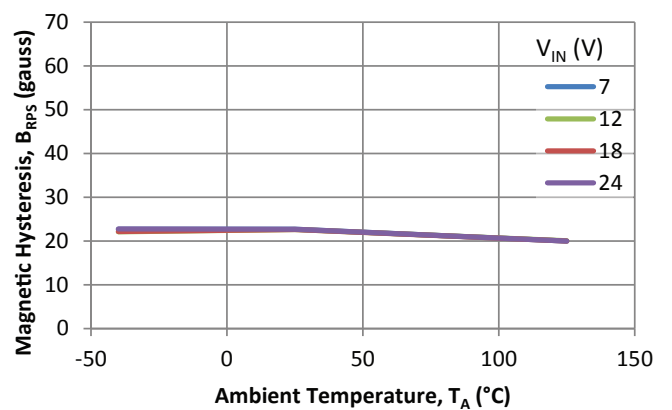

B_{HYSN} vs. V_{IN}

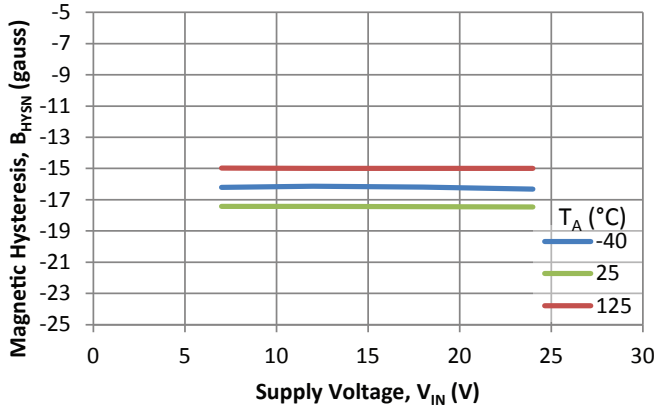

B_{HYSN} vs. T_A

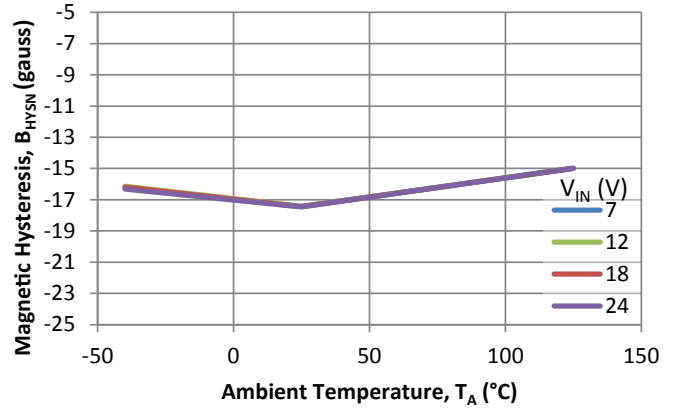

B_{OPN} vs. V_{IN}

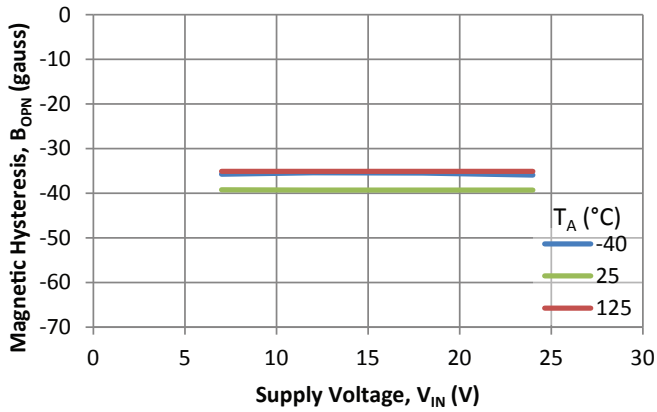

B_{OPN} vs. T_A

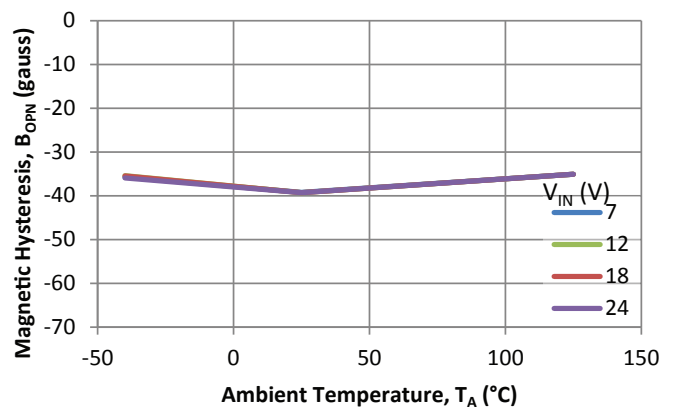

B_{RPN} vs. V_{IN}

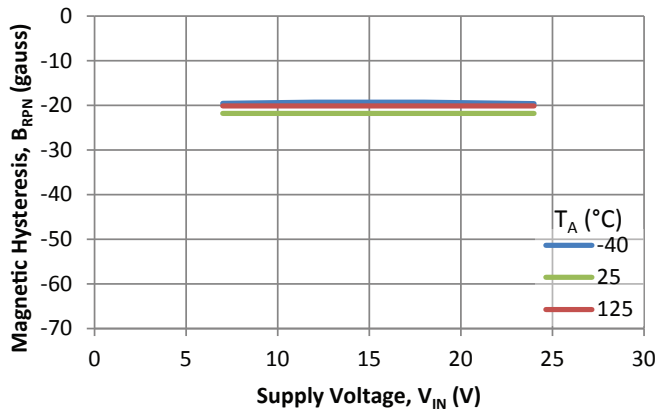

B_{RPN} vs. T_A

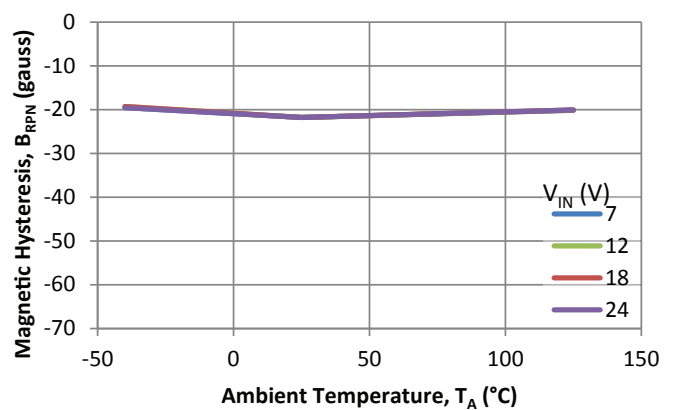

I_{INQ} vs. V_{IN}

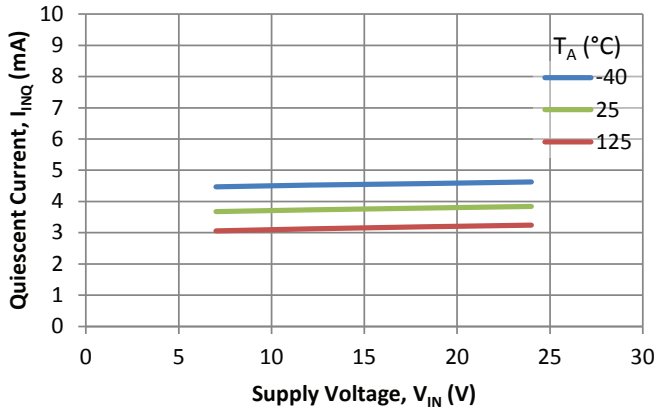

I_{INQ} vs. T_A

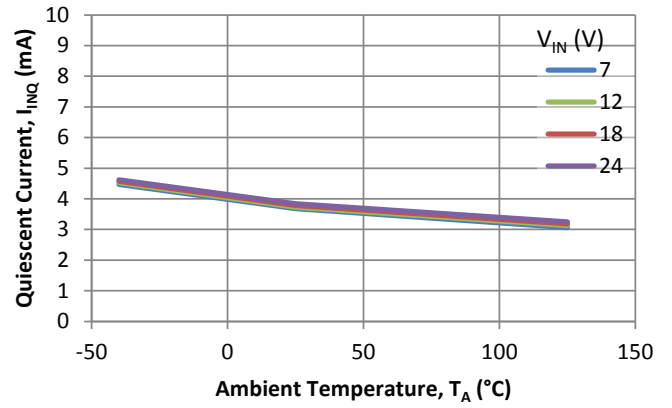

I_{INS} vs. V_{IN}

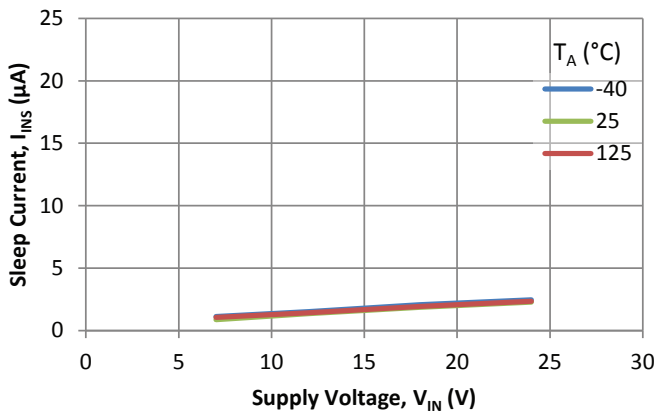

I_{INS} vs. T_A

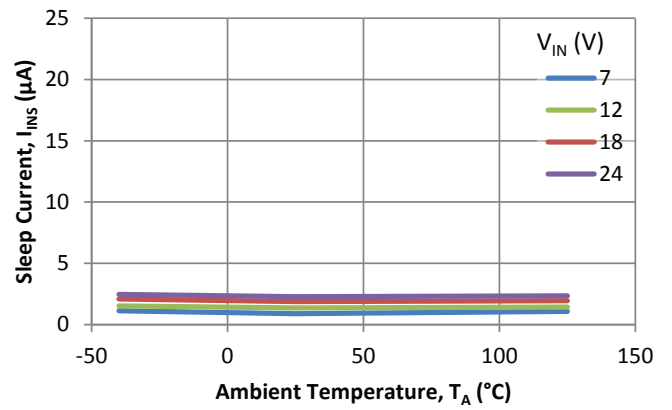

G_H vs. V_{IN} ($I_{REF} = 2\text{ mA}$)

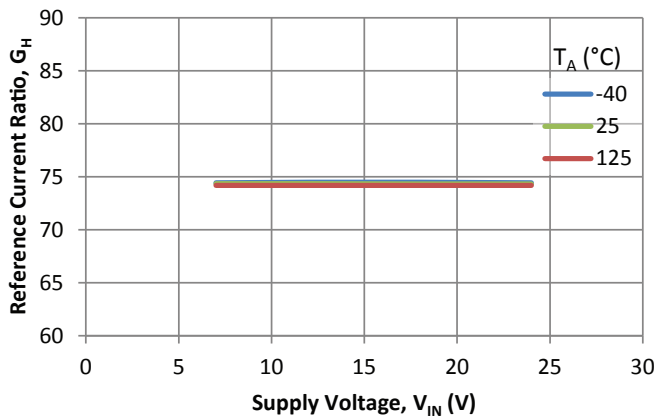

G_H vs. T_A ($I_{REF} = 2\text{ mA}$)

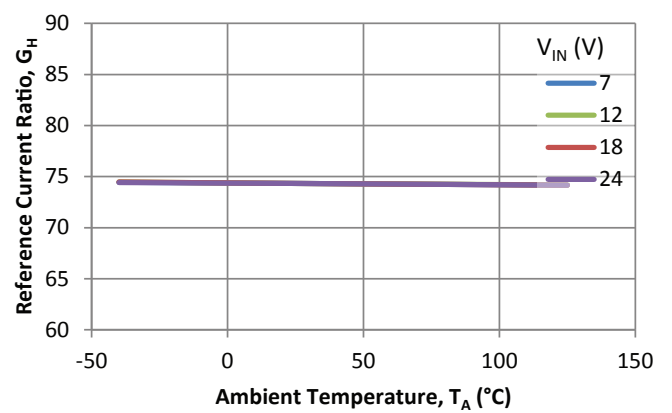

I_{LA} vs. V_{IN}

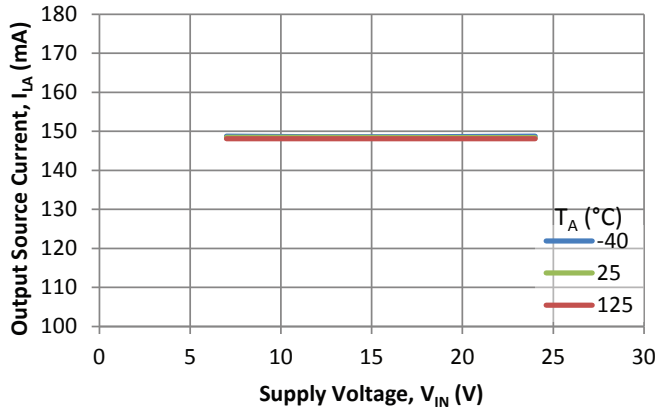

I_{LA} vs. T_A

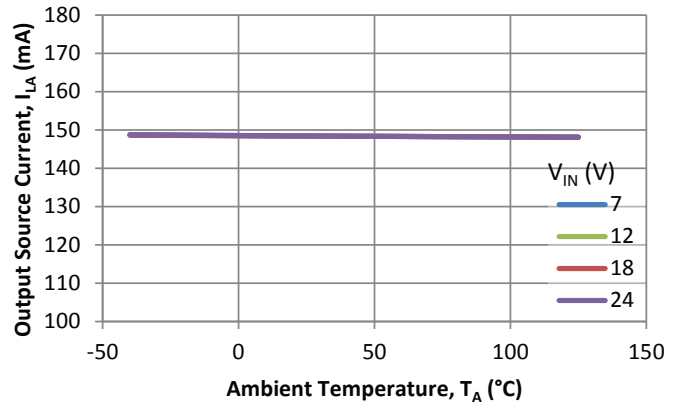

FUNCTION TRUTH TABLE

EXT	SEN_EN	Magnetic Field B	LED
0	0	X	OFF
0	1	$B > B_{OP}$	OFF
0	1	$B < B_{RP}$	ON
1	X	X	ON

Example Function Diagrams

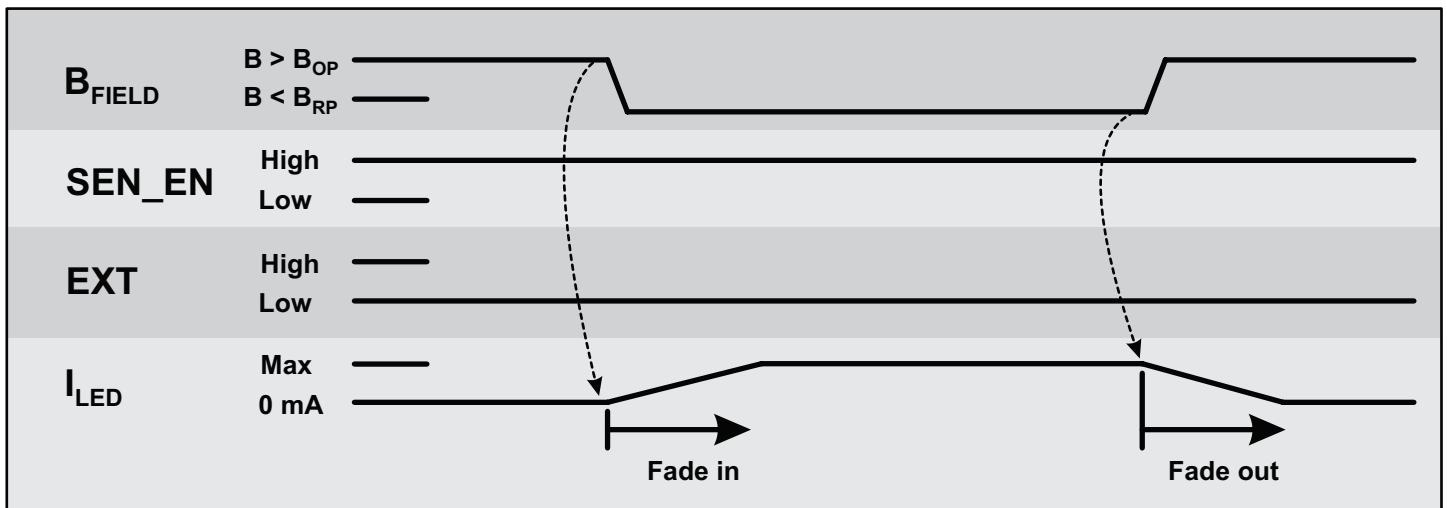

Figure 3: Hall-Activated Operation

With EXT low and SEN_EN high, the switching of the LED is controlled by the B_{FIELD} as detected by the Hall sensor.

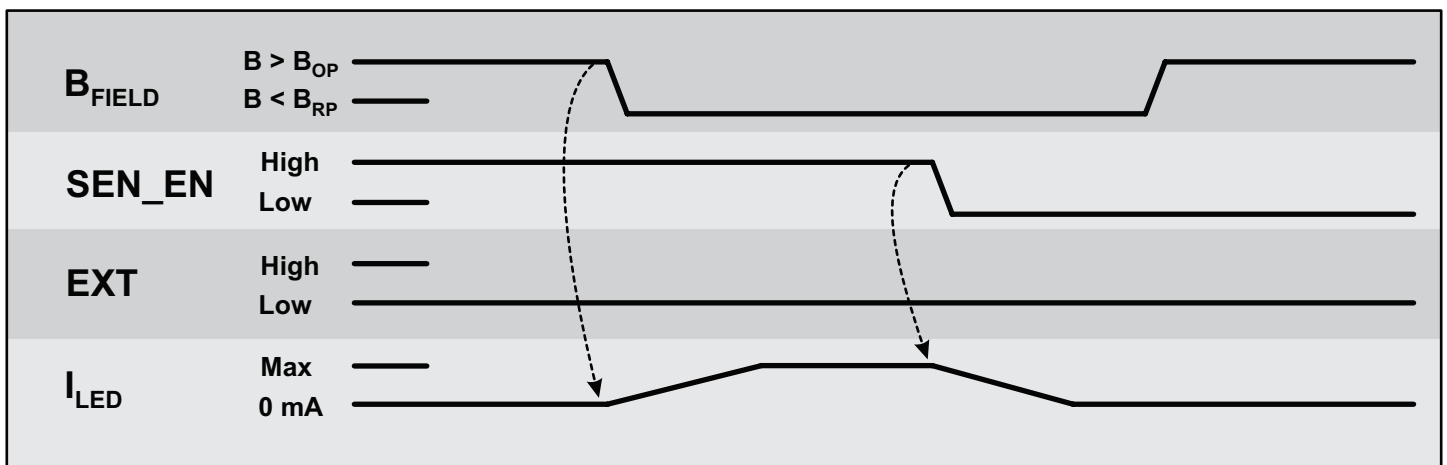

Figure 4: Disabling the Hall Sensor with SEN_EN

The Hall sensor can be disabled by driving SEN_EN low. This will force the LED off even if the B_{FIELD} is below B_{OP}.

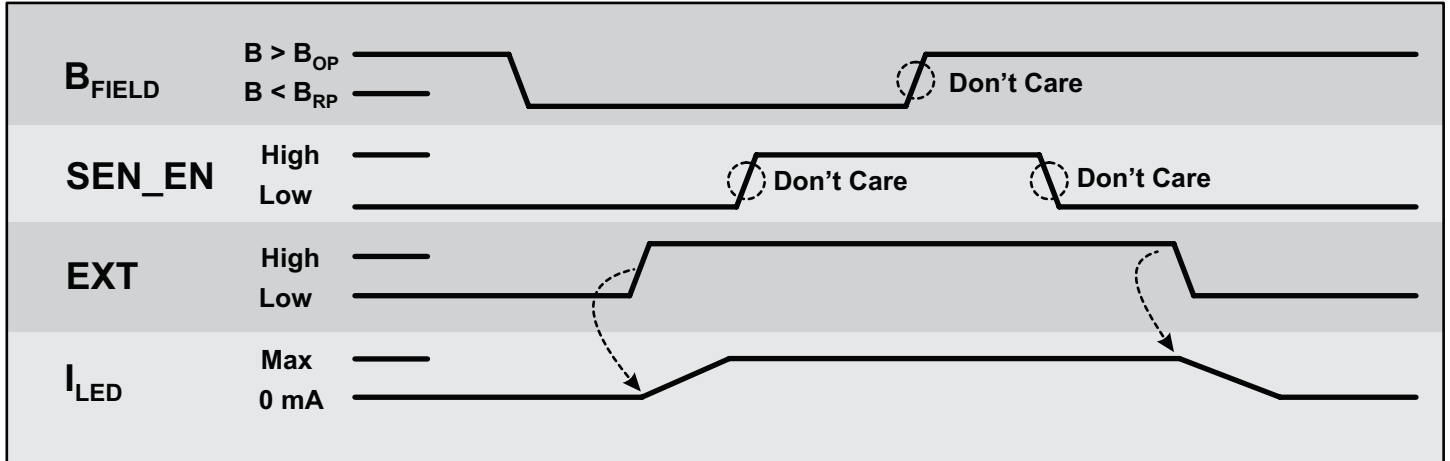

Figure 5: Overriding the Hall Sensor with EXT

When EXT is driven high, it doesn't matter what the state of the SEN_EN input or the B_{FIELD} are, the LED will be on.

FUNCTIONAL DESCRIPTION

The A1569K is a linear current regulator with an integrated Hall-effect switch designed to provide drive current and protection for a string of series-connected high brightness LEDs in automotive applications. It provides a single programmable current output at up to 150 mA, with low minimum dropout voltages below the main supply voltage.

The A1569K is specifically designed for use in illumination applications where the LED activity is controlled by the integrated Hall-effect switch or an external logic signal, or both.

Current regulation is maintained and the LEDs are protected during a short to ground at any point in the LED string. A short to ground on the output terminal will disable the output until the short is removed. Integrated thermal management reduces the regulated current level at high internal junction temperatures to limit power dissipation.

Pin Functions

VIN

Supply to the control circuit and current regulator. A small value ceramic bypass capacitor, typically 100 nF, should be connected from close to this pin to the GND pin.

GND

Ground reference connection. This pin should be connected directly to the negative supply.

SEN_EN

Logic input to enable the Hall-effect switch. When this pin is enabled (logic high), the output current can be controlled by the state of the magnetic field on the Hall sensor. If the magnetic field is below B_{RP} , then the LED current will be on, and if the magnetic field is above B_{OP} , then the LED current will be off.

EXT

Logic input to enable LED current output which provides a direct on/off action. Note, if the LED is on because the SEN_IN pin is enabled and the magnetic field is below B_{RP} , then it will remain on regardless of EXT.

FADE

A capacitor between this pin and GND controls the turn-on and turn-off times of the LED current.

Note: For best performance, it is important that the ground return for C_{FADE} is as short as possible, that it is made directly to the ground pin of the IC, and that it is not shared with other circuitry or carry other ground return currents (Kelvin connection).

IREF

A 1.2 V reference used to set the LED current drive. Connect resistor R_{IREF} to GND to set the reference current.

Note: Do not place any capacitance across the R_{IREF} resistor.

THTH

When floating, the thermal monitor threshold T_{JM} is enabled and the output current will start to reduce with increasing temperature above 130°C. Connecting the THTH pin directly to GND will disable the thermal monitor function; however, the thermal shut-down feature will continue to function—it cannot be disabled. Refer to the Temperature Monitor section below for more detail.

LA

Current source connected to the anode of the first LED in the string.

PAD

This is an isolated pad for thermal dissipation only. This pad is isolated and can be connected to ground or left floating.

LED Current Level

The LED current is controlled by a linear current regulator between the VIN pin and the LA output. The basic equation that determines the nominal output current at this pin is:

Given SEN_EN = high and $B_{FIELD} < B_{RP}$, or EXT = high,

$$I_{LA} = \frac{V_{REF} \times G_H}{R_{IREF}} \quad (1)$$

where I_{LA} is in A, R_{IREF} is in Ω , $V_{REF} = 1.2$ V, and $G_H = 75$.

Note: the output current may be reduced from the set level by the thermal monitor circuit.

Conversely, the reference resistor may be calculated from:

$$R_{IREF} = \frac{V_{REF} \times G_H}{I_{LA} + 0.5} \quad (2)$$

where I_{LA} is in A, R_{IREF} is in Ω , $V_{REF} = 1.2$ V, and $G_H = 75$.

For example, where the required current is 75 mA, the resistor value will be:

$$R_{IREF} = \frac{90}{0.075 + 0.0005} = 1192 \Omega \text{ or } 1.19 \text{ k}\Omega \quad (3)$$

It is important to note that because the A1569K is a linear regulator, the maximum regulated current is limited by the power dissipation and the thermal management in the application. All current calculations assume an adequate heat sink, or airflow, or both, for the power dissipated. Thermal management is at least as important as the electrical design in all applications. In high current, high ambient temperature applications, the thermal management is the most important aspect of the systems design. The application section below provides further detail on thermal management and the associated limitations.

Sleep Mode

When SEN_EN and EXT are held low, the A1569K will be in shutdown mode and all sections will be in a low power sleep mode. The input current will be typically less than 10 μ A.

Fade-In/Fade-Out

Fade timing is controlled by external capacitor C_{FADE} on the FADE pin. A larger capacitor will result in a longer fade time. The 10%-90% fade time is approximated by the equation:

$$t_{FADE} = C_{FADE} \times 0.8 \times 10^6 \quad (4)$$

where t_{FADE} is in seconds and C_{FADE} is in farads.

Therefore, C_{FADE} of 1 μ F will result in t_{FADE} of approximately 1 second ($t_{FADE} = 0.000001 \text{ F} \times 0.8 \times 10^6 = 0.8$ seconds).

Fade-in is triggered when:

- EXT goes high, or
- SEN_EN is high and B_FIELD goes below B_RP, or
- B_FIELD is below B_RP and SEN_EN goes high.

Fade-out is triggered when:

- SEN_EN is low or B_FIELD is above B_OP and EXT goes low, or
- EXT is low and B_FIELD is above B_OP and SEN_EN goes low, or
- EXT is low and SEN_EN is high and B_FIELD goes above B_OP.

Safety Features

The circuit includes several features to ensure safe operation and to protect the LEDs and the A1569K:

- The current regulator between VIN and LA output provide a natural current limit due to the regulation.
- The LA output includes a short-to-ground detector that will disable the output to limit the dissipation.
- The thermal monitor reduces the regulated current as the temperature rises.
- Thermal shutdown completely disables the outputs under extreme overtemperature conditions.

SHORT-CIRCUIT DETECTION

A short to ground on any LED cathode as in Figure 6 will not result in a short fault condition. The current through the remaining LEDs will remain in regulation and the LEDs will be protected. If the LA output is pulled below the short detect voltage as in Figure 7, it will disable the regulator on the output. A small current will be sourced from the disabled output to monitor the short and detect when it is removed. When the voltage at LA rises above the short detect voltage, the regulator will be re-enabled. A shorted LED or LEDs, as in Figure 8, will not result in a short fault condition. The current through the remaining LEDs will remain in regulation and the LEDs will be protected.

Temperature Monitor and Thermal Protection

The temperature monitor function, included in the A1569K, reduces the LED current as the silicon junction temperature of the A1569K increases (see Figure 9). By mounting the A1569K on the same thermal substrate as the LEDs, this feature can also be

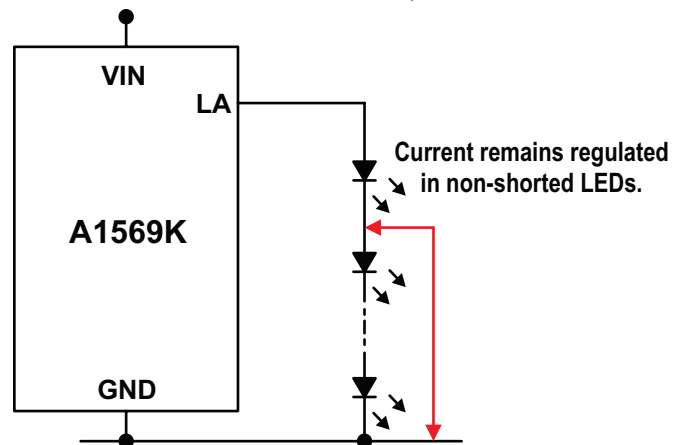

Figure 6: Any Cathode Short to Ground

used to limit the dissipation of the LEDs. As the junction temperature of the A1569K increases, the regulated current level is reduced, reducing the dissipated power in the A1569K and in the LEDs. The current is reduced from the 100% level at typically 2.5% per degree Celsius until the point at which the current drops to 25% of the full value, defined at T_{JL} . Above this temperature, the current will continue to reduce at a lower rate until the temperature reaches the overtemperature shutdown threshold temperature (T_{JF}).

In extreme cases, if the chip temperature exceeds the overtemperature limit (T_{JF}), the regulator will be disabled. The tem-

perature will continue to be monitored and the regulator will be re-activated when the temperature drops below the threshold provided by the specified hysteresis. Note that it is possible for the A1569K to transition rapidly between thermal shutdown and normal operation. This can happen if the thermal mass attached to the exposed thermal pad is small and T_{JM} is too close to the shutdown temperature. The period of oscillation will depend on T_{JM} , the dissipated power, the thermal mass of any heat sink present, and the ambient temperature.

When THTH is left open, the temperature at which the current reduction begins is defined as the thermal monitor activation temperature (T_{JM}) and is specified in the characteristics table at the 90% current level.

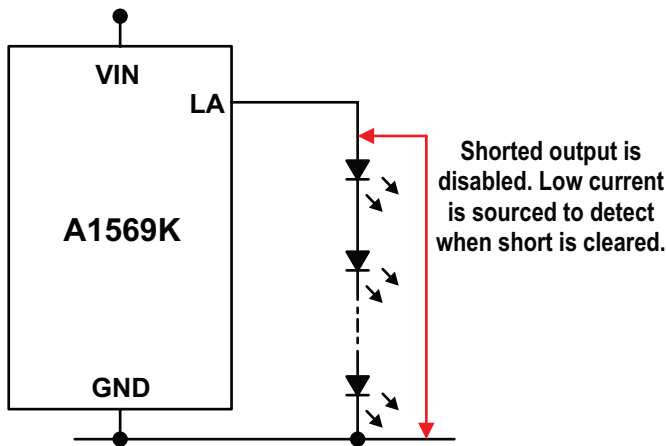

Figure 7: Output Short to Ground

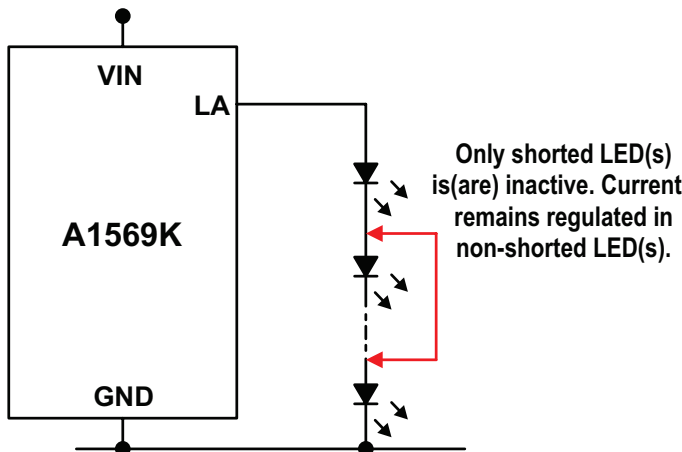

Figure 8: Shorted LED(s)

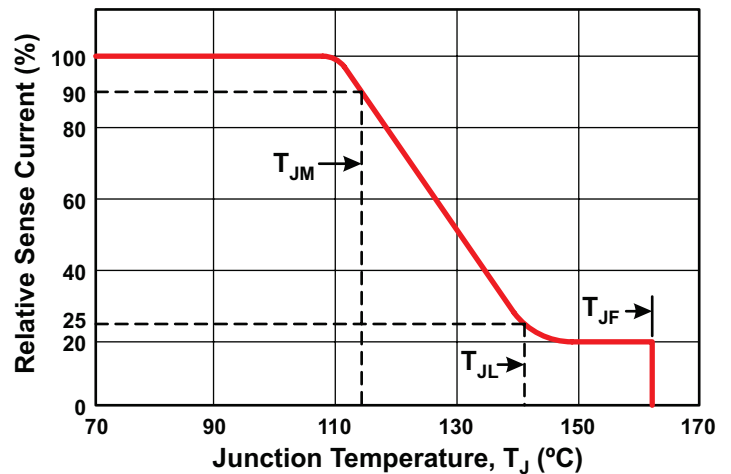

Figure 9: Temperature Monitor Current Reduction

When THTH is tied to ground, the thermal monitor function is disabled; however, the overtemperature thermal protection will continue to function—it cannot be disabled.

APPLICATION INFORMATION

Power Dissipation

The most critical design consideration when using a linear regulator such as the A1569K is the power produced internally as heat and the rate at which that heat can be dissipated.

There are three sources of power dissipation in the A1569K:

- The quiescent power to run the control circuits
- The power in the reference circuit
- The power due to the regulator voltage drop

QUIESCENT POWER

The quiescent power is the product of the quiescent current (I_{INQ}) and the supply voltage (V_{IN}), and it is not related to the regulated current. The quiescent power (P_Q) is therefore defined as:

$$P_Q = V_{IN} \times I_{INQ} \quad (5)$$

REFERENCE POWER

The reference circuit draws the reference current from the supply and passes it through the reference resistor to ground. The reference circuit power is the product of the reference current and the difference between the supply voltage and the reference voltage, typically 1.2 V. The reference power (P_{REF}) is therefore defined as:

$$P_{REF} = \frac{(V_{IN} - V_{REF}) \times V_{REF}}{R_{IREF}} \quad (6)$$

REGULATOR POWER

In most application circuits, the largest dissipation will be produced by the output current regulator. The power dissipated the current regulator is simply the product of the output current and the voltage drop across the regulator. The regulator power the output is defined as:

$$P_{REG} = (V_{IN} - V_{LED}) \times I_{LED} \quad (7)$$

Note that the voltage drop across the regulator (V_{REG}) is always greater than the specified minimum dropout voltage (V_{DO}). The output current is regulated by making this voltage large enough to provide the voltage drop from the supply voltage to the total forward voltage of all LEDs in series (V_{LED}). The total power dissipated in the A1569K is the sum of the quiescent power, the reference power, and the power in the regulator:

$$P_D = P_Q + P_{REG} - P_{REF} \quad (8)$$

The power that is dissipated in the LEDs is:

$$P_{LED} = V_{LED} \times I_{LED} \quad (9)$$

where V_{LED} is the voltage across all LEDs in the string.

From these equations (and as illustrated in Figure 10), it can be seen that, if the power in the A1569K is not limited, then it will increase as the supply voltage increases while the power in the LEDs will remain constant.

Dissipation Limits

There are two features limiting the power that can be dissipated by the A1569K: thermal shutdown and thermal foldback.

THERMAL SHUTDOWN

If the thermal foldback feature is disabled by connecting the THTH pin to GND, or if the thermal resistance from the A1569K to the ambient environment is high, then the silicon temperature will rise to the thermal shutdown threshold and the current will be disabled. After the current is disabled, the power dissipated will drop and the temperature will fall. When the temperature falls by the hysteresis of the thermal shutdown circuit, the current will be re-enabled and the temperature will start to rise again. This cycle will repeat continuously until the ambient temperature drops or the A1569K is switched off. The period of this thermal shutdown cycle will depend on several electrical, mechanical, and thermal parameters.

THERMAL FOLDBACK

If $R_{\theta JA}$ is low enough, then the thermal foldback feature will have time to act. This will limit the silicon temperature by reducing the regulated current and therefore the dissipation.

The thermal monitor will reduce the LED current as the temperature of the A1569K increases above the thermal monitor activation temperature (T_{JM}), as shown in Figure 11. The figure shows the operation of the A1569K with a string of two white LEDs running at 150 mA. The forward voltage of each LED is 3.15 V, and the graph shows the current as the supply voltage increases from 15 to 18 V. As the supply voltage increases, without the thermal foldback feature, the current would remain at 150 mA, as shown by the dashed line. The solid line shows the resulting current decrease as the thermal foldback feature acts.

If the thermal foldback feature did not affect LED current, the current would increase the power dissipation and therefore the silicon temperature. The thermal foldback feature reduces power in the A1569K in order to limit the temperature increase, as shown in Figure 12. The figure shows the operation of the A1569K under the same conditions as Figure 11, that is, a string of two white LEDs running at 150 mA, with each LED forward voltage at 3.15 V. The graph shows the temperature as the supply voltage increases from 15 to 18 V. Without the thermal foldback

feature, the temperature would continue to increase up to the thermal shutdown temperature, as shown by the dashed line. The solid line shows the effect of the thermal foldback function in limiting the temperature rise.

Figure 11 and Figure 12 show the thermal effects where the thermal resistance from the silicon to the ambient temperature is 40°C/W. Thermal performance can be enhanced further by using a significant amount of thermal vias as described below.

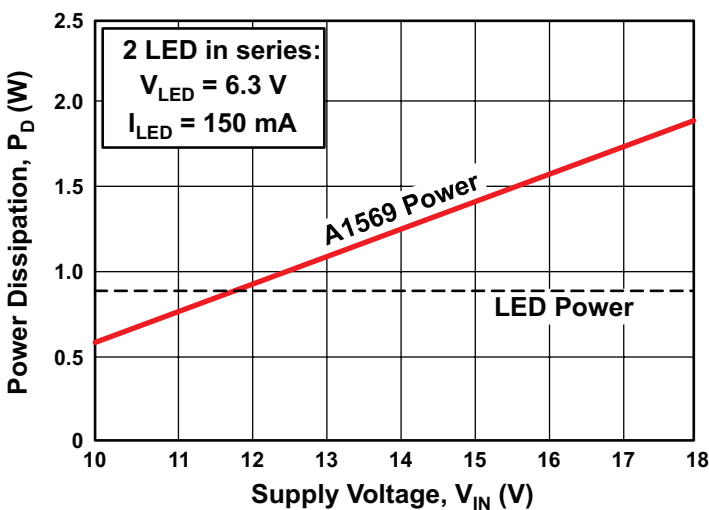

Figure 10: Power Dissipation versus Supply Voltage

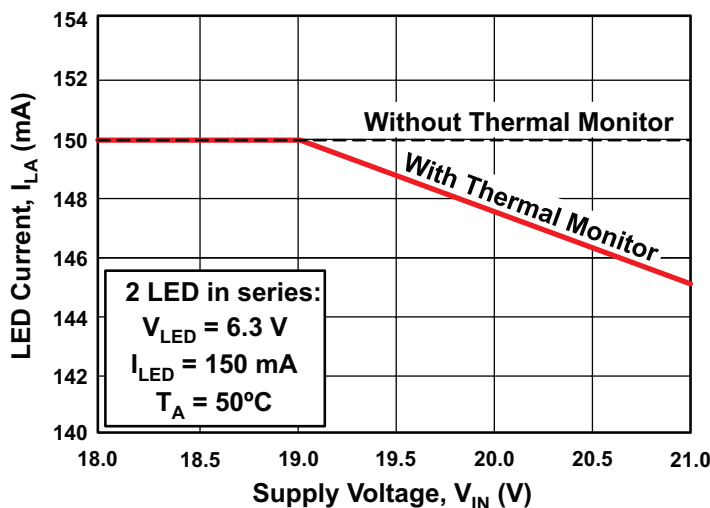

Figure 11: LED Current versus Supply Voltage

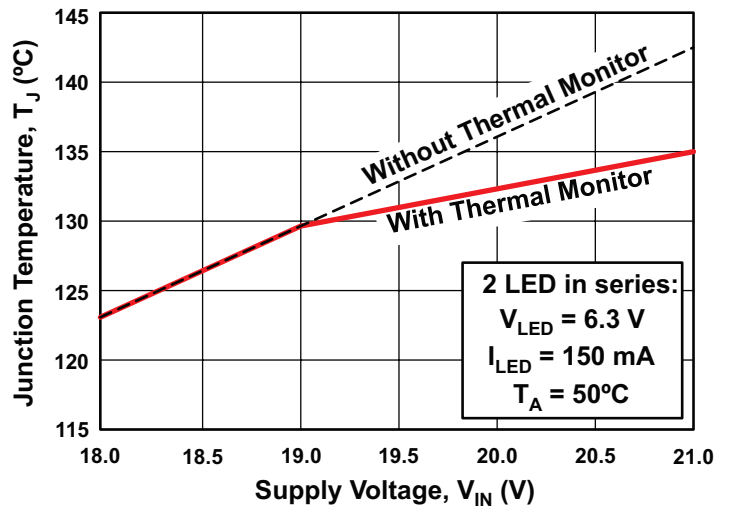

Figure 12: Junction Temperature versus Supply Voltage

Supply Voltage Limits

In many applications, especially in automotive systems, the available supply voltage can vary over a two-to-one range, or greater when double battery or load dump conditions are taken into consideration. In such systems, is it necessary to design the application circuit such that the system meets the required performance targets over a specified voltage range.

To determine this range when using the A1569K, there are two limiting conditions:

- For maximum supply voltage, the limiting factor is the power that can be dissipated from the regulator without exceeding the temperature at which the thermal foldback starts to reduce the output current below an acceptable level.
- For minimum supply voltage, the limiting factor is the maximum dropout voltage of the regulator, where the difference between the load voltage and the supply is insufficient for the regulator to maintain control over the output current.

Minimum Supply Limit: Regulator Saturation Voltage

The supply voltage (V_{IN}) is always the sum of the voltage drop across the high-side regulator (V_{REG}) and the forward voltage of the LEDs in the string (V_{LED}).

V_{LED} is constant for a given current and does not vary with supply voltage. Therefore, V_{REG} provides the variable difference between V_{LED} and V_{IN} . V_{REG} has a minimum value below which

the regulator can no longer be guaranteed to maintain the output current within the specified accuracy. This level is defined as the regulator dropout voltage (V_{DO}).

The minimum supply voltage, below which the LED current does not meet the specified accuracy, is therefore determined by the sum of the minimum dropout voltage (V_{DO}) and the forward voltage of the LEDs in the string (V_{LED}). The supply voltage must always be greater than this value and the minimum specified supply voltage, that is:

$$V_{IN} > V_{DO} + V_{LED} \text{ and } V_{IN} > V_{IN(MIN)} \quad (10)$$

As an example, consider the configuration used in Figure 11, namely a string of two white LEDs, running at 150 mA, with each LED forward voltage at 3.15 V. The minimum supply voltage will be approximately:

$$V_{IN(MIN)} = 0.8 + (2 \times 3.15) = 7.1 \text{ V} \quad (11)$$

Maximum Supply Limit: Thermal Limitation

As described above, when the thermal monitor reaches the activation temperature (T_{JM}), due to increased power dissipation as the supply voltage rises, the thermal foldback feature causes the output current to decrease. The maximum supply voltage is therefore defined as the voltage above which the LED current drops below the acceptable minimum.

This can be estimated by determining the maximum power that can be dissipated before the internal (junction) temperature of the A1569K reaches T_{JM} .

Note that, if the thermal monitor circuit is disabled (by connecting the THTH pin to GND), then the maximum supply limit will be the specified maximum continuous operating temperature, 150°C.

The maximum power dissipation is therefore defined as:

$$P_{D(MAX)} = \frac{\Delta T_{(MAX)}}{R_{\theta JA}} \quad (12)$$

where $\Delta T_{(MAX)}$ is the difference between the thermal monitor activation temperature (T_{JM}) of the A1569K and the maximum ambient temperature ($T_{A(max)}$), and $R_{\theta JA}$ is the thermal resistance from the internal junctions in the silicon to the ambient environment. If minimum LED current is not a critical factor, then the maximum voltage is simply the maximum specified in the parameter tables above.

Thermal Dissipation

The amount of heat that can pass from the silicon of the A1569K to the surrounding ambient environment depends on the thermal resistance of the structures connected to the A1569K. The thermal resistance ($R_{\theta JA}$) is a measure of the temperature rise created by power dissipation and is usually measured in degrees Celsius per watt ($^{\circ}\text{C}/\text{W}$).

The temperature rise (ΔT) is calculated from the power dissipated (P_D) and the thermal resistance ($R_{\theta JA}$) as:

$$\Delta T = P_D \times R_{\theta JA} \quad (13)$$

A thermal resistance from silicon to ambient ($R_{\theta JA}$) of approximately $35^{\circ}\text{C}/\text{W}$ can be achieved by using a high thermal conductivity, multilayer printed circuit board as specified in the JEDEC standards JESD51-7 for JEDEC Package MS-012 BA (including thermal vias as called out in JESD51-5). Additional improvements may be achieved by optimizing the PCB design.

Optimizing Thermal Layout

The features of the printed circuit board, including heat conduction and adjacent thermal sources such as other components, have a significant effect on the thermal performance of the device. To optimize thermal performance, the following should be taken into account:

- Maximizing the forward voltage of the LEDs relative to the V_{IN} of the A1569K will greatly reduce the power dissipated in the A1569K by reducing the voltage drop across the A1569K.
- The A1569K exposed thermal pad should be connected to as much copper area as is available. This copper area may be left floating or connected to ground if desired.
- Copper thickness should be as high as possible (for example, 2 oz. or greater for higher power applications).
- The greater the quantity of thermal vias, the better the dissipation. If the expense of vias is a concern, studies have shown that concentrating the vias directly under the device in a tight pattern, as shown in Figure 13, has the greatest effect.
- Additional exposed copper area on the opposite side of the board should be connected by means of thermal vias. The copper should cover as much area as possible.
- Other thermal sources should be placed as far away from the device as possible.

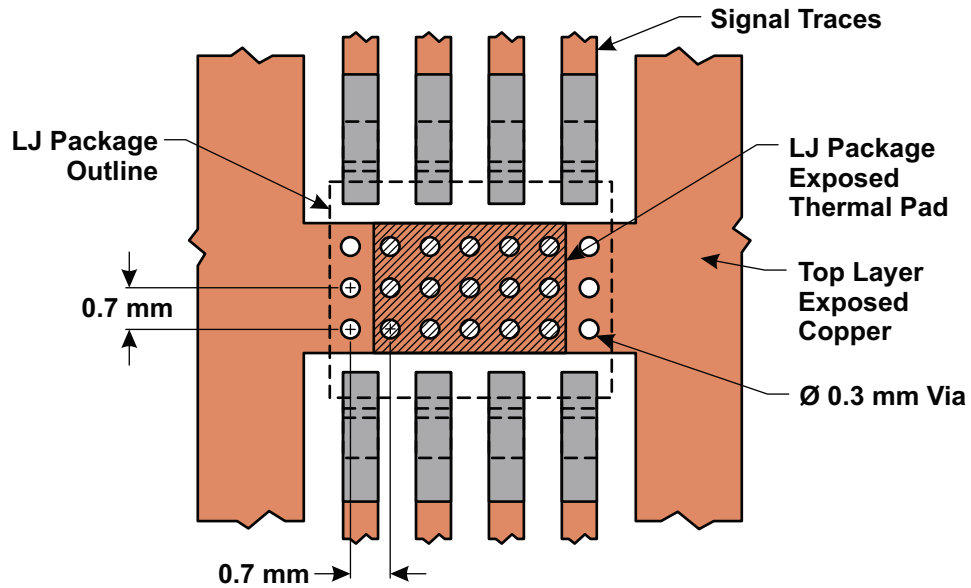

Figure 13: Suggested PCB Layout for Thermal Optimization

(Maximum available bottom-layer copper recommended)

PACKAGE OUTLINE DRAWING

For Reference Only – Not for Tooling Use

(Reference Allegro DWG-0000380, Rev. 2 and JEDEC MS-012BA)
 Dimensions in millimeters – NOT TO SCALE
 Dimensions exclusive of mold flash, gate burrs, and dambar protrusions
 Exact case and lead configuration at supplier discretion within limits shown

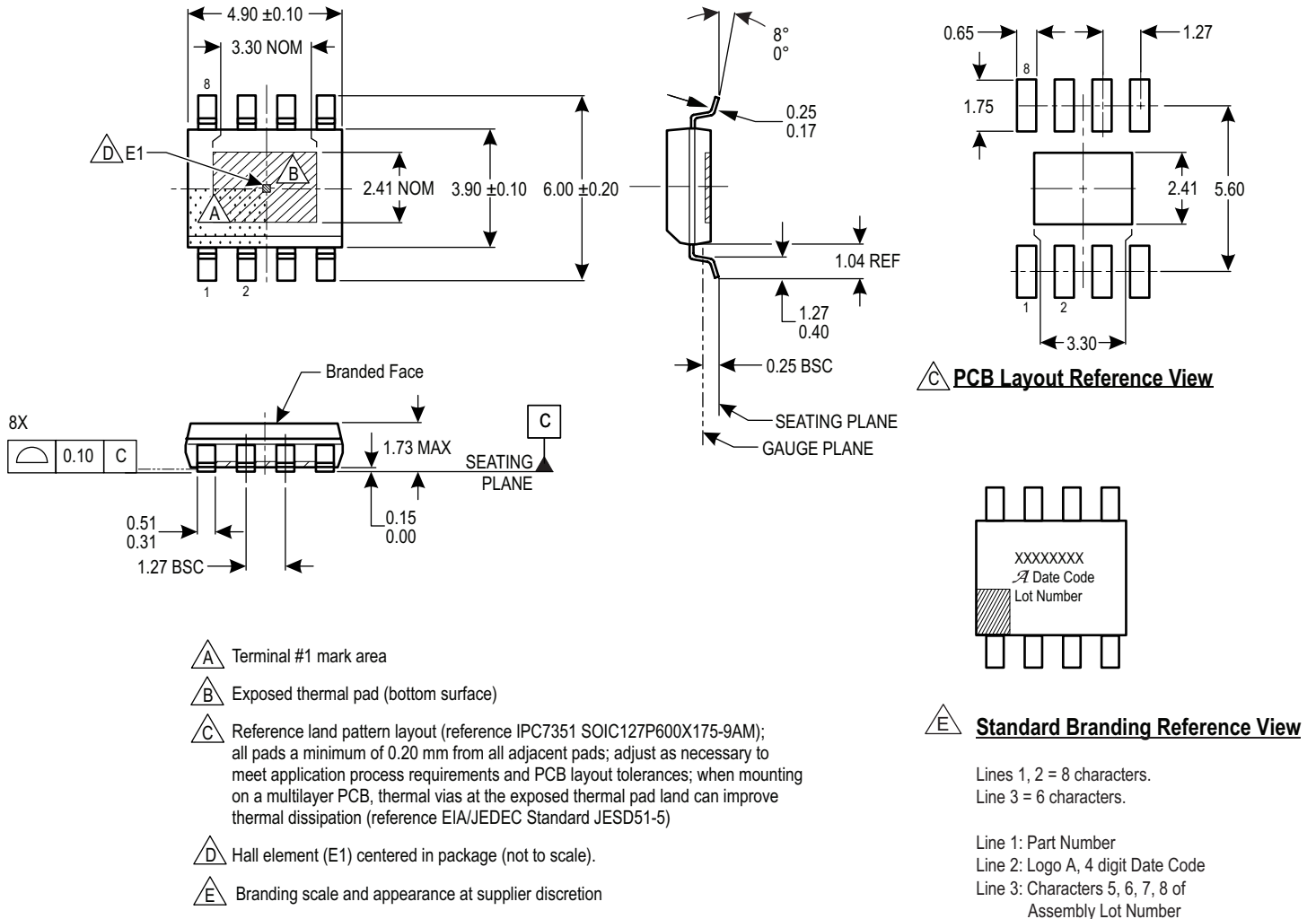

Figure 14: Package LJ, 8-Pin SOICN with Exposed Thermal Pad

REVISION HISTORY

Number	Date	Description
–	December 11, 2015	Initial release
1	February 22, 2019	Minor editorial updates
2	March 6, 2020	Minor editorial updates
3	March 7, 2022	Updated package drawing (page 20)

Copyright 2022, Allegro MicroSystems.

Allegro MicroSystems reserves the right to make, from time to time, such departures from the detail specifications as may be required to permit improvements in the performance, reliability, or manufacturability of its products. Before placing an order, the user is cautioned to verify that the information being relied upon is current.

Allegro's products are not to be used in any devices or systems, including but not limited to life support devices or systems, in which a failure of Allegro's product can reasonably be expected to cause bodily harm.

The information included herein is believed to be accurate and reliable. However, Allegro MicroSystems assumes no responsibility for its use; nor for any infringement of patents or other rights of third parties which may result from its use.

Copies of this document are considered uncontrolled documents.

For the latest version of this document, visit our website:

www.allegromicro.com