



SPECIFICATIONS

Model	Rated Torque	Damping Direction	Max Rotation Speed
FDT-70B-903	8.7±0.8Nm (87±8kgfcm)	Both directions	50 RPM

Max Cycle Rate	Operating Temperature	Weight	Body Material	Rotor (Shaft) Material	Oil Type
12 cycles/min.	-10 ~ 50°C	112g	Iron	Nylon/glass fiber composite	Silicone Oil

Note) Rated torque is measured at a rotation speed of 20rpm at 23°C±3°C
 FDT-63B-703 has a slotted rotating shaft opening

DAMPING CHARACTERISTICS

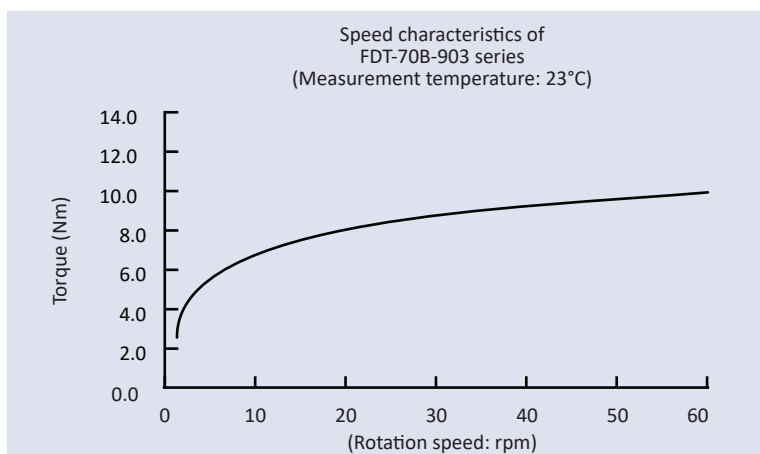

- **Speed characteristics:** A disk damper's torque varies according to the rotation speed. In general, as shown in the graph to the left, the torque increases as the rotation speed increases, and the torque decreases as the rotation speed decreases. Torque at 20 rpm is shown in this document. In a closing lid, the rotation speed is slow when the lid begins to close, resulting in the generation of torque that is smaller than the rated torque.

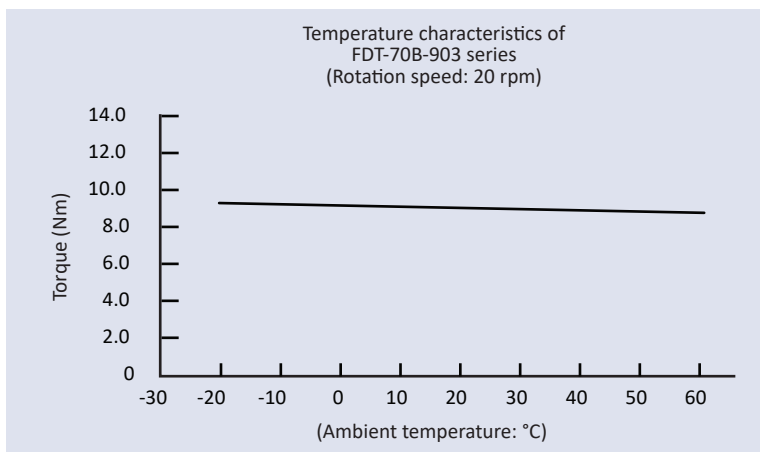

- **Temperature characteristics:** Damper torque (rated torque in this document) varies according to the ambient temperature. As the temperature increases, the torque decreases, and as the temperature decreases, the torque increases. This is because the viscosity of the silicone oil inside the damper varies according to the temperature. The graph to the left illustrates the temperature characteristics.

USING THE DAMPER

Shafts external dimensions	Ø10mm - Ø9.97mm
Surface hardness	HRC55 or higher
Quenching depth	0.5mm or higher
Surface roughness	1.0Z or lower
Chamfer end (Damper insertion side)	CO.2~CO.3 (or RO.2~RO.3)

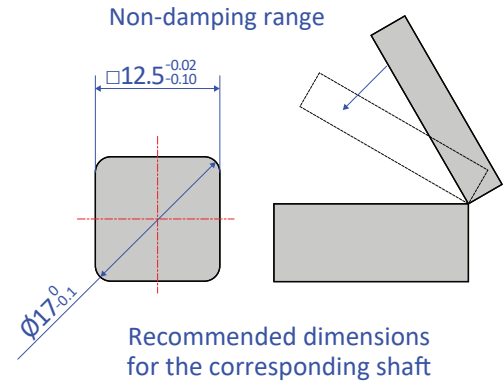

- FDT-70B dampers generate torque in both directions.
- Please make sure that a shaft attached to a damper has a bearing, as the damper itself is not fitted with one.
- When using FDT-70B, please ensure that a shaft with the specified angular dimensions is inserted in the damper's shaft opening. A wobbling shaft may not allow the lid to slow down properly when closing. Please see the diagram for the recommended square shaft dimensions.

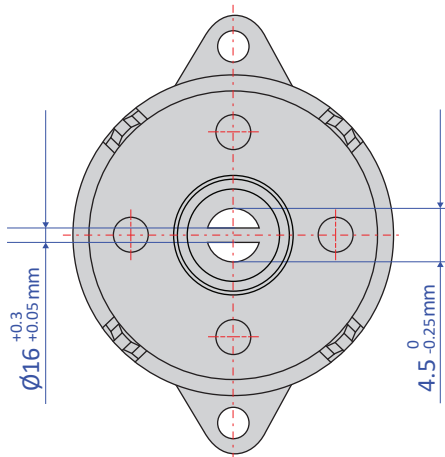

The FDT-70B-903 has a slotted groove which is excellent for usage with spiral springs