

NOTES:

- MATERIAL:
CONNECTOR:
HOUSING - HIGH TEMPERATURE THERMOPLASTIC GLASS FILLED, UL 94V-0, BLACK
TERMINALS - COPPER ALLOY
SHELL
SILVER NICKEL, C770, THICKNESS: 0.250/0.254
- FINISH:
CONNECTOR
OPTION 1
CONTACT AREA - 0.38µm MIN GOLD OVER 2.54 µm NICKEL
SOLDER FOOT AREA - 2.54-5.09µm TIN OVER 1.27 µm NICKEL
OPTION 2
CONTACT AREA - 0.76µm MIN GOLD OVER 2.54 µm NICKEL
SOLDER FOOT AREA - 2.54-5.09µm TIN OVER 1.27 µm NICKEL
- TERMINAL SOLDER FEET TO BE COPLANAR WITHIN 0.10 MEASURED FROM FRONT HOUSING STAND OFF (DATUM C)
- DATE CODE: 4 DIGIT (3 DIGIT DAY, 1 DIGIT YEAR) CONNECTOR ONLY
- CIRCUIT IDENTIFIER: SEE APPROPRIATE INDUSTRY SPECIFICATION FOR LOCATION OF PIN 1.
- TO BE USED WITH THE FOLLOWING CABLE SERIES:
79575/74563/79576/74573/79536/74562/74586
- PACKAGED PER PACKAGING SPECIFICATION: PK-75783-001
- CONFORMS TO PRODUCT SPECIFICATION: PS-75783-001
- PROCESS PER APPLICATION SPECIFICATION: AS-75783-001
- THIS PART CONFORMS TO CLASS C REQUIREMENTS OF COSMETIC SPEC PS-45499-002

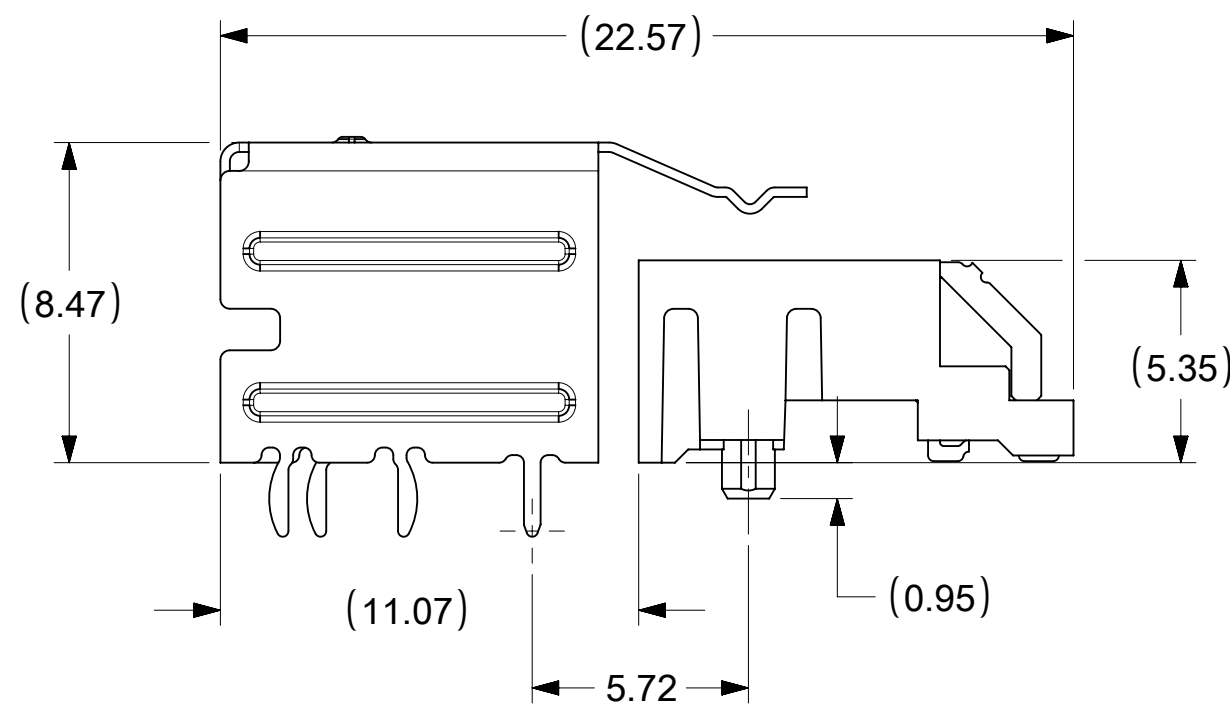
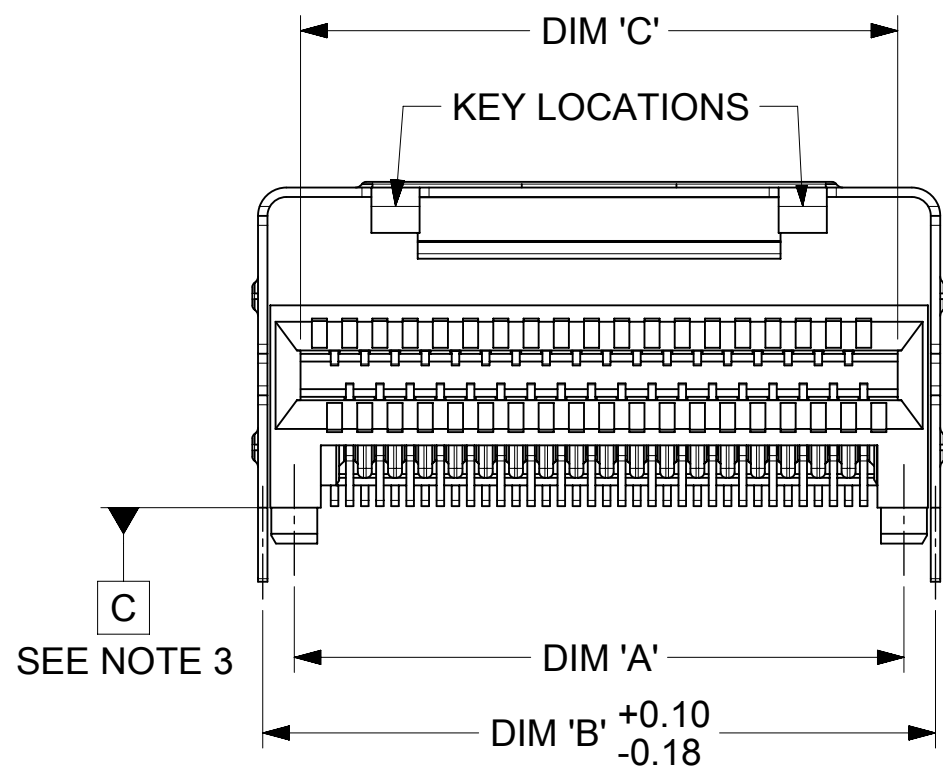

36 CIRCUIT
RETENTION FIT
SHELL OPTION SHOWN

| CIRCUIT SIZE | DIM 'A' | DIM 'B' | DIM 'C' |
|--------------|---------|---------|---------|
| 26 | 12.00 | 13.80 | 11.80 |
| 36 | 16.00 | 17.80 | 15.80 |
| 50 | 21.60 | 23.40 | 21.40 |
| 68 | 28.80 | 30.60 | 28.60 |

| SYMBOLS | | THIS DRAWING CONTAINS INFORMATION THAT IS PROPRIETARY TO MOLEX ELECTRONIC TECHNOLOGIES, LLC AND SHOULD NOT BE USED WITHOUT WRITTEN PERMISSION | |
|-----------------|--|---|---|
| DIMENSION UNITS | SCALE | CURRENT REV DESC: OBSOLETE PART NO | |
| ▽ = 0 | mm | 5:1 | molex I-PASS R/A CONNECTOR INTERNAL ASSY W/SHELL 0.8MM PITCH I/O |
| ▽ = 0 | GENERAL TOLERANCES (UNLESS SPECIFIED) | | |
| ▽ = 0 | ANGULAR TOL ± 0.5° | | EC NO: 696749 DRWN: MUM 2019/03/27 CHK'D: GB 2019/11/06 APPR: JKACHLIC 2022/02/23 |
| ▽ = 0 | 4 PLACES ± | | |
| ▽ = 0 | 3 PLACES ± | | INITIAL REVISION: DRWN: KLANG 2005/04/15 APPR: RNELSON 2005/04/18 |
| ▽ = 0 | 2 PLACES ± 0.13 | | |
| ▽ = 0 | 1 PLACE ± 0.25 | | DOCUMENT NUMBER SD-75783-001 DOC TYPE DOC PART REVISION PSD 001 F1 |
| ▽ = 0 | 0 PLACES ± | | |
| ▽ = 0 | DRAFT WHERE APPLICABLE MUST REMAIN WITHIN DIMENSIONS | | PRODUCT CUSTOMER DRAWING MATERIAL NUMBER CUSTOMER SHEET NUMBER SEE TABLE GENERAL MARKET 1 OF 13 |
| ▽ = 0 | THIRD ANGLE PROJECTION | DRAWING SERIES | |
| ▽ = 0 | | C-SIZE 75783 | |

RIGHT ANGLE CONNECTOR WITH SMT SHELL PCB FOOT PRINT

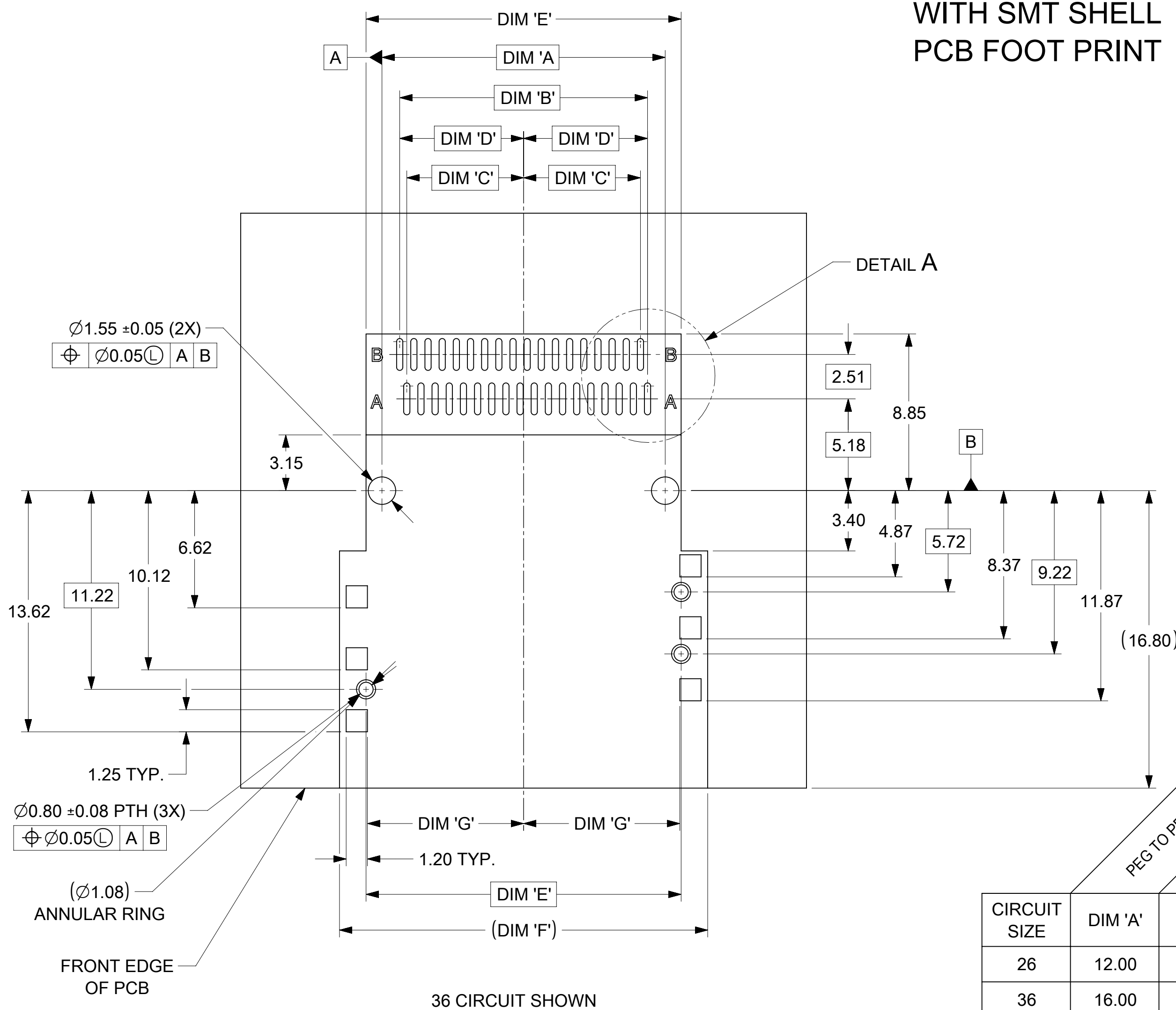

DETAIL A

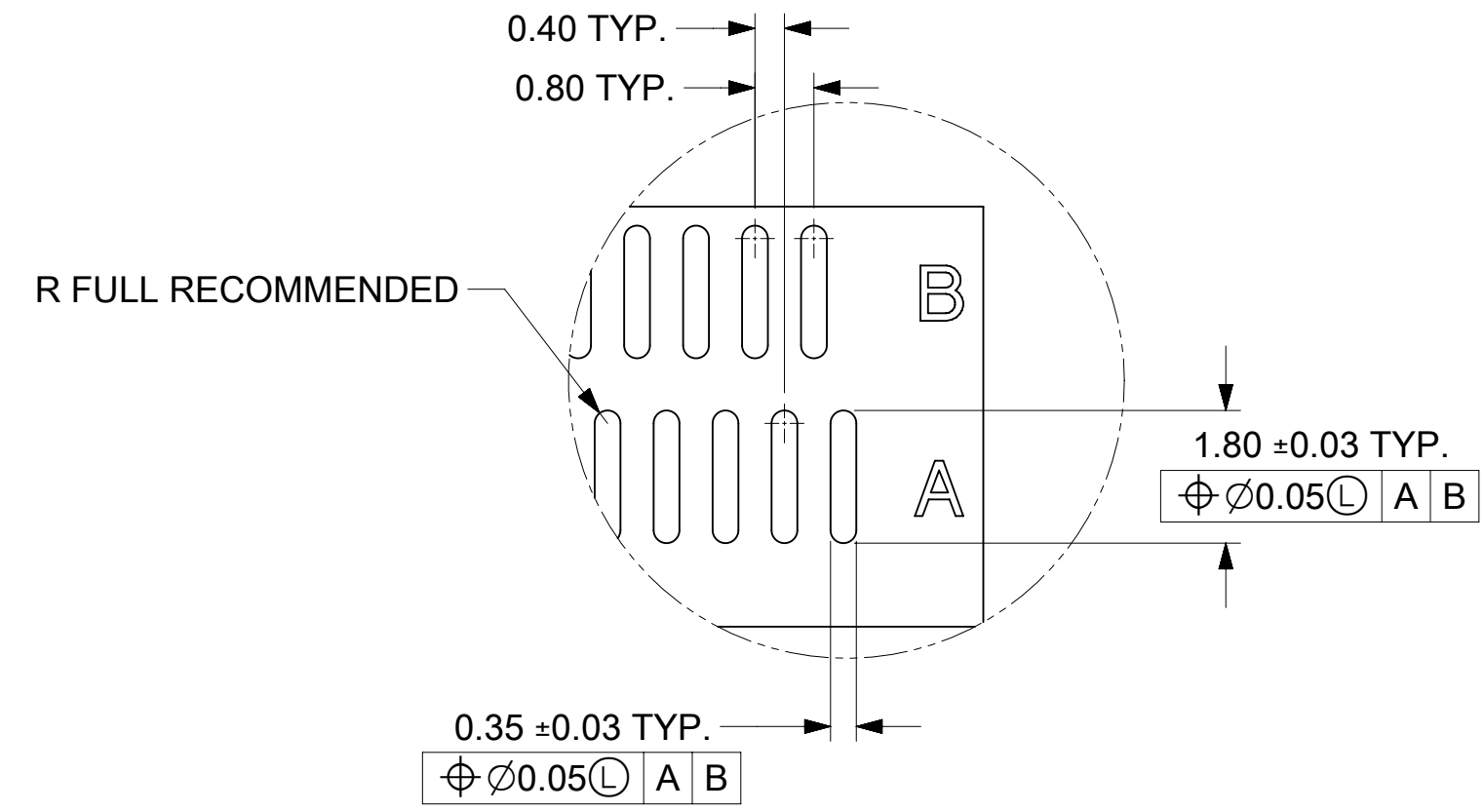

DETAIL A
SCALE 10:1

| CIRCUIT SIZE | DIMENSIONS | | | | | | |
|--------------|------------|-----------------------|-------------------|-------------------|----------------------------------|-----------------------|------------------------|
| | PEG TO PEG | FIRST PAD TO LAST PAD | CENTERLINE TO PAD | CENTERLINE TO PAD | CONNECTOR WIDTH SHELL PEG TO PEG | SHELL FOOTPRINT WIDTH | CENTERLINE TO PAD EDGE |
| 26 | DIM 'A' | DIM 'B' | DIM 'C' | DIM 'D' | DIM 'E' | DIM 'F' | DIM 'G' |
| 36 | 12.00 | 10.00 | 4.60 | 5.00 | 13.80 | 16.80 | 6.825 |
| 50 | 21.60 | 19.60 | 9.40 | 9.80 | 23.40 | 26.40 | 11.625 |
| 68 | 28.80 | 26.80 | 13.00 | 13.40 | 30.60 | 33.60 | 15.225 |

| | | | | | | | |
|--|-------|------------------------|-------|---|-------|-------|-------|
| SYMBOLS | | | | THIS DRAWING CONTAINS INFORMATION THAT IS PROPRIETARY TO MOLEX ELECTRONIC TECHNOLOGIES, LLC AND SHOULD NOT BE USED WITHOUT WRITTEN PERMISSION | | | |
| ▽ = 0 | ▽ = 0 | ▽ = 0 | ▽ = 0 | ▽ = 0 | ▽ = 0 | ▽ = 0 | ▽ = 0 |
| DIMENSION UNITS | | SCALE | | CURRENT REV DESC: OBSOLETE PART NO | | | |
| mm | | 5:1 | | | | | |
| GENERAL TOLERANCES (UNLESS SPECIFIED) | | | | | | | |
| ANGULAR TOL ± 0.5° | | 4 PLACES ± | | EC NO: 696749 | | | |
| 3 PLACES ± | | 2 PLACES ± 0.13 | | DRWN: MUM 2019/03/27 | | | |
| 1 PLACE ± 0.25 | | 0 PLACES ± | | CHK'D: GB 2019/11/06 | | | |
| DRAFT WHERE APPLICABLE MUST REMAIN WITHIN DIMENSIONS | | THIRD ANGLE PROJECTION | | APPR: JKACHLIC 2022/02/23 | | | |
| DRAWING | | SERIES | | INITIAL REVISION: | | | |
| C-SIZE | | 75783 | | DRWN: KLANG 2005/04/15 | | | |
| MATERIAL NUMBER | | CUSTOMER | | APPR: RNELSON 2005/04/18 | | | |
| SEE TABLE | | GENERAL MARKET | | DOCUMENT NUMBER | | | |
| SD-75783-001 | | PSD 001 | | DOC TYPE DOC PART REVISION | | | |
| SHEET NUMBER | | 2 OF 13 | | F1 | | | |

RIGHT ANGLE CONNECTOR WITH SHELL PCB FOOT PRINT DESCRIPTIONS

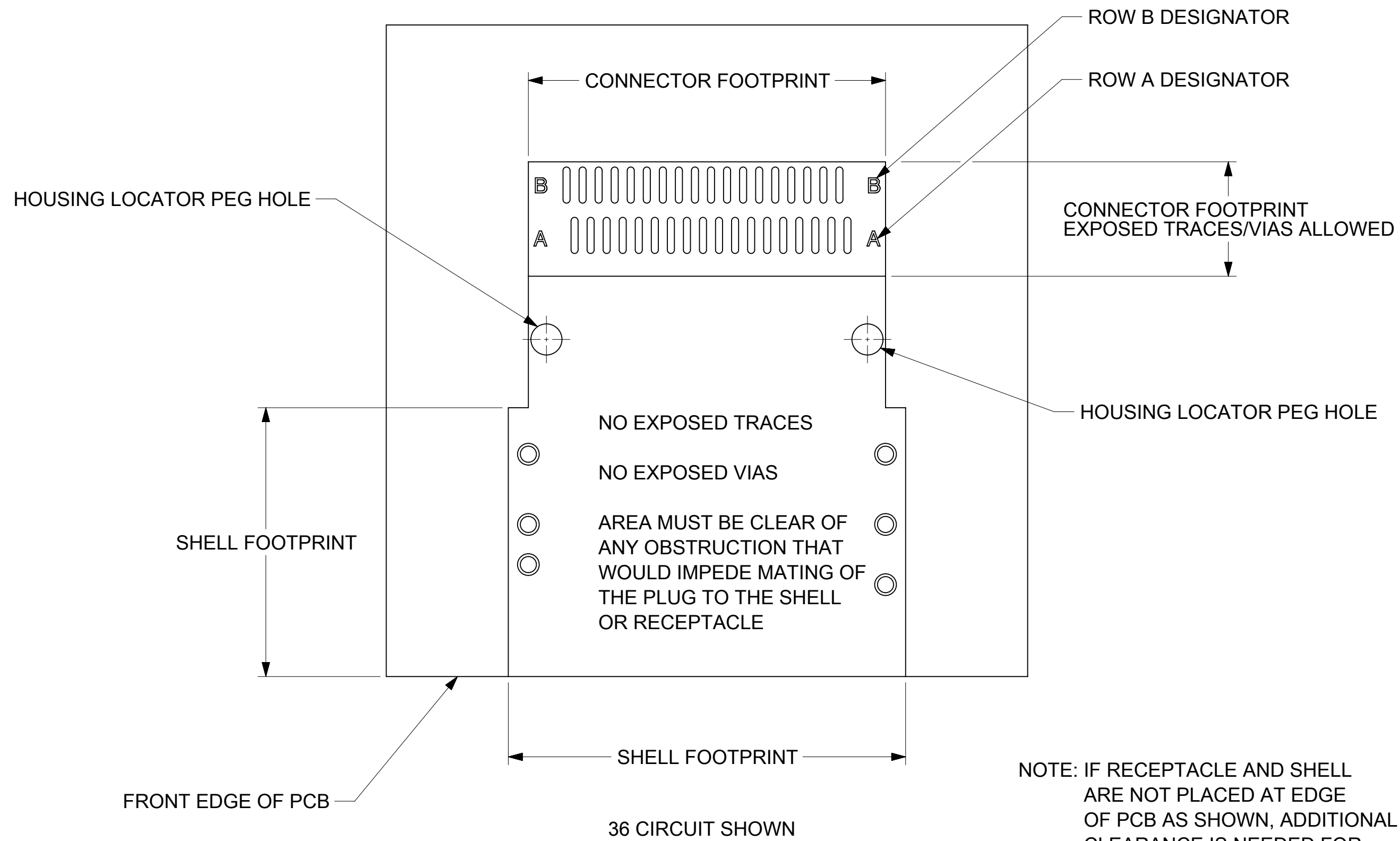

| | | | | | | | | | |
|---|--|--|--|---------|--|---|--|---------------------------------------|--|
| THIS DRAWING CONTAINS INFORMATION THAT IS PROPRIETARY TO MOLEX ELECTRONIC TECHNOLOGIES, LLC AND SHOULD NOT BE USED WITHOUT WRITTEN PERMISSION | | | | | | | | | |
| SYMBOLS | | DIMENSION UNITS | | SCALE | | CURRENT REV DESC: OBSOLETE PART NO | | | |
| ▽ = 0 | | mm | | 5:1 | | molex I-PASS R/A CONNECTOR INTERNAL ASSY W/SHELL 0.8MM PITCH I/O | | | |
| ▽ = 0 | | GENERAL TOLERANCES (UNLESS SPECIFIED) | | | | | | | |
| ▽ = 0 | | ANGULAR TOL ± 0.5° | | | | EC NO: 696749 | | | |
| ▽ = 0 | | 4 PLACES ± | | | | DRWN: MUM 2019/03/27 | | | |
| ▽ = 0 | | 3 PLACES ± | | | | CHK'D: GB 2019/11/06 | | | |
| ▽ = 0 | | 2 PLACES ± 0.13 | | | | APPR: JKACHLIC 2022/02/23 | | | |
| ▽ = 0 | | 1 PLACE ± 0.25 | | | | INITIAL REVISION: | | | |
| ☒ = 0 | | 0 PLACES ± | | | | DRWN: KLANG 2005/04/15 | | | |
| ■ = 0 | | DRAFT WHERE APPLICABLE MUST REMAIN WITHIN DIMENSIONS | | | | APPR: RNELSON 2005/04/18 | | | |
| ▽ = 0 | | THIRD ANGLE PROJECTION | | DRAWING | | SERIES | | DOCUMENT NUMBER | |
| | | | | C-SIZE | | 75783 | | SD-75783-001 | |
| | | | | | | | | DOC TYPE DOC PART REVISION | |
| | | | | | | | | PSD 001 F1 | |
| | | | | | | | | MATERIAL NUMBER CUSTOMER SHEET NUMBER | |
| | | | | | | | | SEE TABLE GENERAL MARKET 3 OF 13 | |

MATING INTERFACE (FOR REFERENCE ONLY)

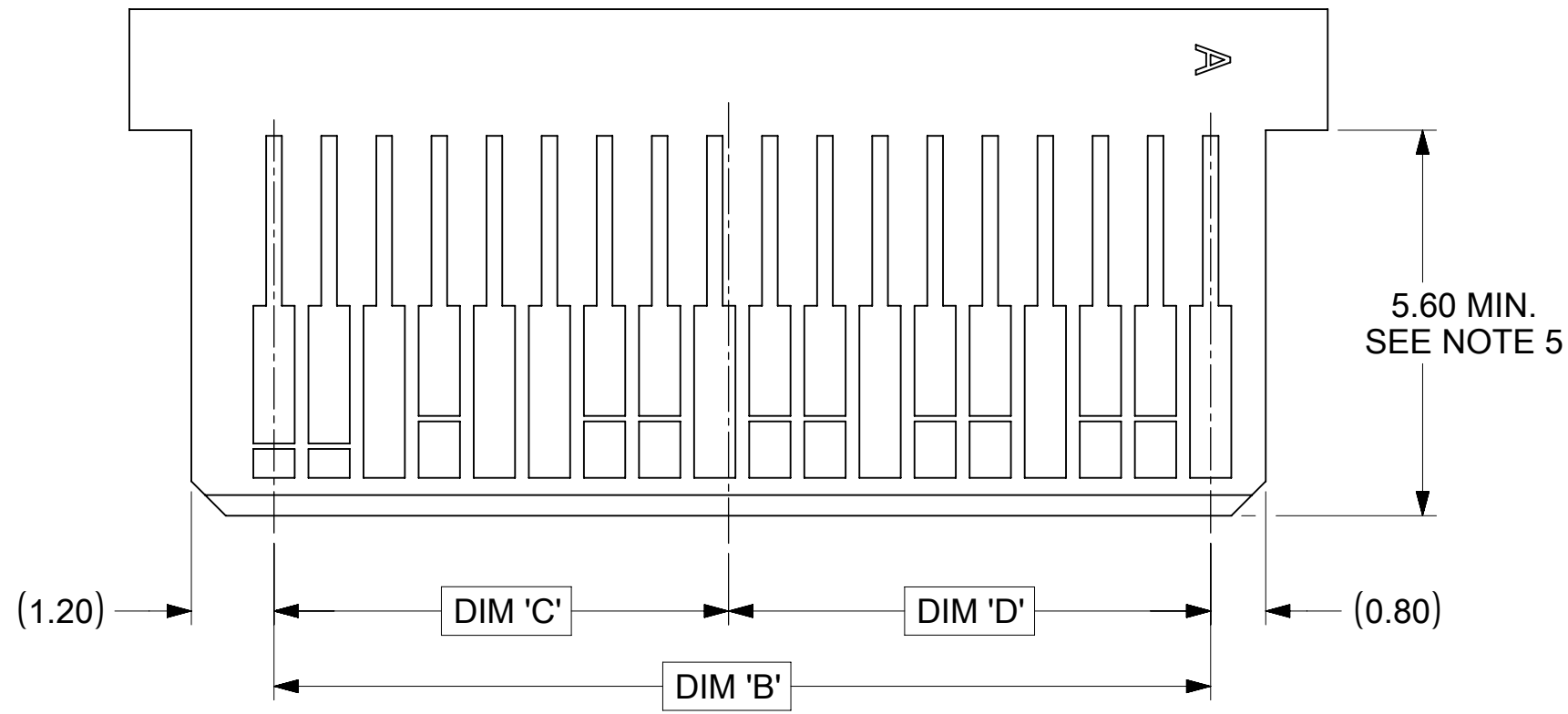
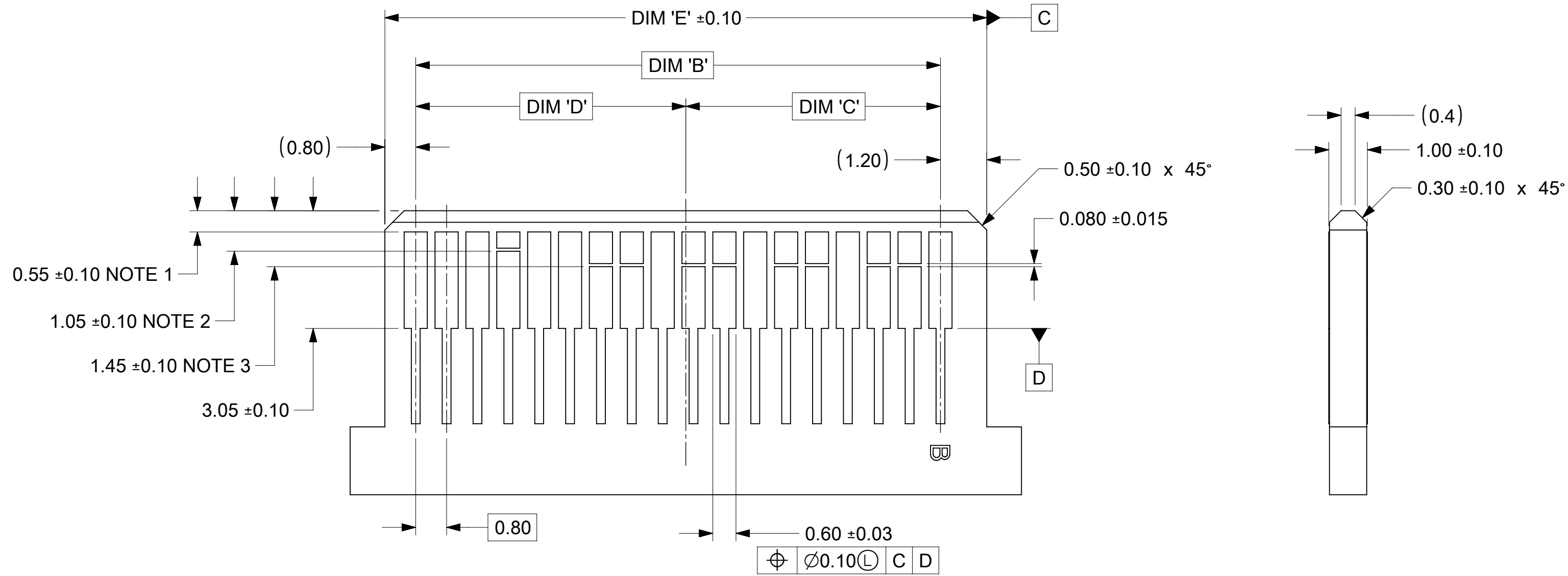

36 CIRCUIT SHOWN

- NOTES:
- PAD CONFIGURATION FOR FIRST MATE.
 - PAD CONFIGURATION FOR SECOND MATE.
 - PAD CONFIGURATION FOR THIRD MATE.
(HIGH SPEED SIGNALS)
 - FOR PIN ASSIGNMENTS AND MATING SEQUENCE (1ST, 2ND, 3RD), SEE APPLICABLE SPECIFICATION.
 - MINIMUM STEP REQUIRED IF PCB MADE WIDER THAN TONGUE.

| CIRCUIT SIZE | DIM 'A' | DIM 'B' | DIM 'C' | DIM 'D' | DIM 'E' |
|--------------|---------|---------|---------|---------|---------|
| 26 | 13 | 9.60 | 4.60 | 5.00 | 11.60 |
| 36 | 18 | 13.60 | 6.60 | 7.00 | 15.60 |
| 50 | 25 | 19.20 | 9.40 | 9.80 | 21.20 |
| 68 | 34 | 26.40 | 13.00 | 13.40 | 28.40 |

| | | | | | |
|---------|---|--------|--|-----------------|---------------|
| SYMBOLS | THIS DRAWING CONTAINS INFORMATION THAT IS PROPRIETARY TO MOLEX ELECTRONIC TECHNOLOGIES, LLC AND SHOULD NOT BE USED WITHOUT WRITTEN PERMISSION | | | | |
| | DIMENSION UNITS | SCALE | CURRENT REV DESC: OBSOLETE PART NO | | |
| ▽ = 0 | mm | 10:1 | EC NO: 696749 DRWN: MUM 2019/03/27 CHK'D: GB 2019/11/06 APPR: JKACHLIC 2022/02/23 | | |
| ▽ = 0 | GENERAL TOLERANCES (UNLESS SPECIFIED) | | | | |
| ▽ = 0 | ANGULAR TOL ± 0.5° | | INITIAL REVISION: DRWN: KLANG 2005/04/15 APPR: RNELSON 2005/04/18 | | |
| ▽ = 0 | 4 PLACES | ± | | | |
| ▽ = 0 | 3 PLACES | ± | DOCUMENT NUMBER: SD-75783-001 DOC TYPE: PSD DOC PART: 001 REVISION: F1 | | |
| ▽ = 0 | 2 PLACES | ± 0.13 | | | |
| ▽ = 0 | 1 PLACE | ± 0.25 | MATERIAL NUMBER: SEE TABLE CUSTOMER: GENERAL MARKET SHEET NUMBER: 4 OF 13 | | |
| ▽ = 0 | 0 PLACES | ± | | | |
| ▽ = 0 | DRAFT WHERE APPLICABLE MUST REMAIN WITHIN DIMENSIONS | | THIRD ANGLE PROJECTION | DRAWING: C-SIZE | SERIES: 75783 |

molex

I-PASS R/A CONNECTOR
INTERNAL ASSY W/SHELL 0.8MM PITCH I/O

PRODUCT CUSTOMER DRAWING

SD-75783-001

PSD 001 F1

SEE TABLE GENERAL MARKET 4 OF 13

ASSEMBLY WITH PRE-POSITION DEVICE

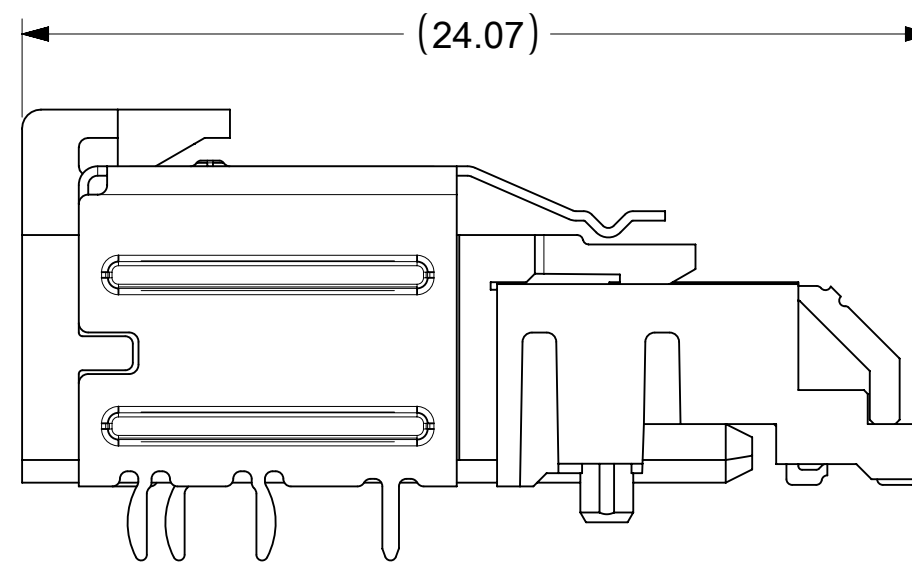
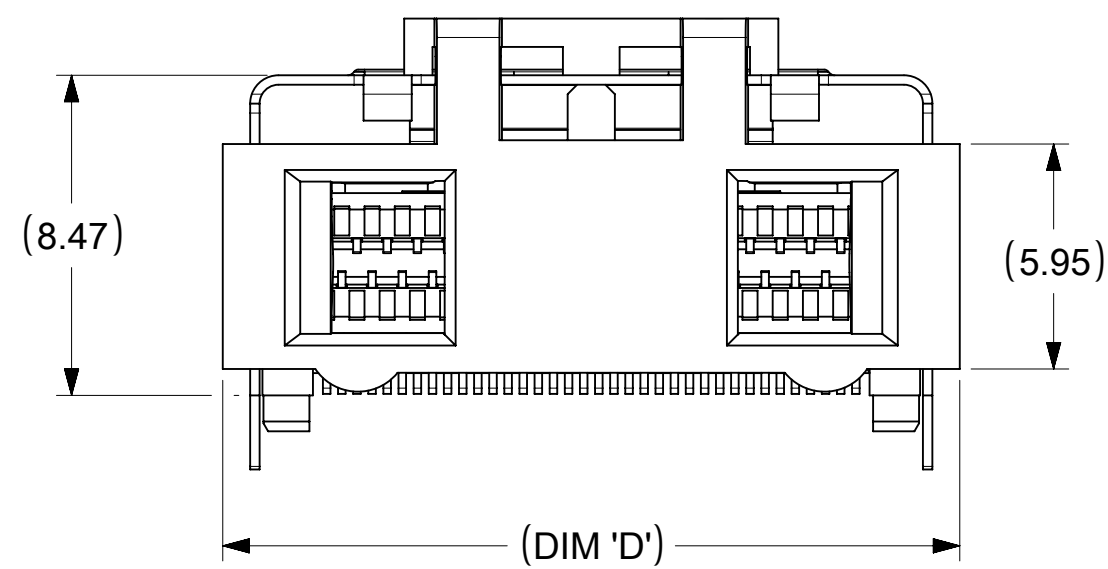
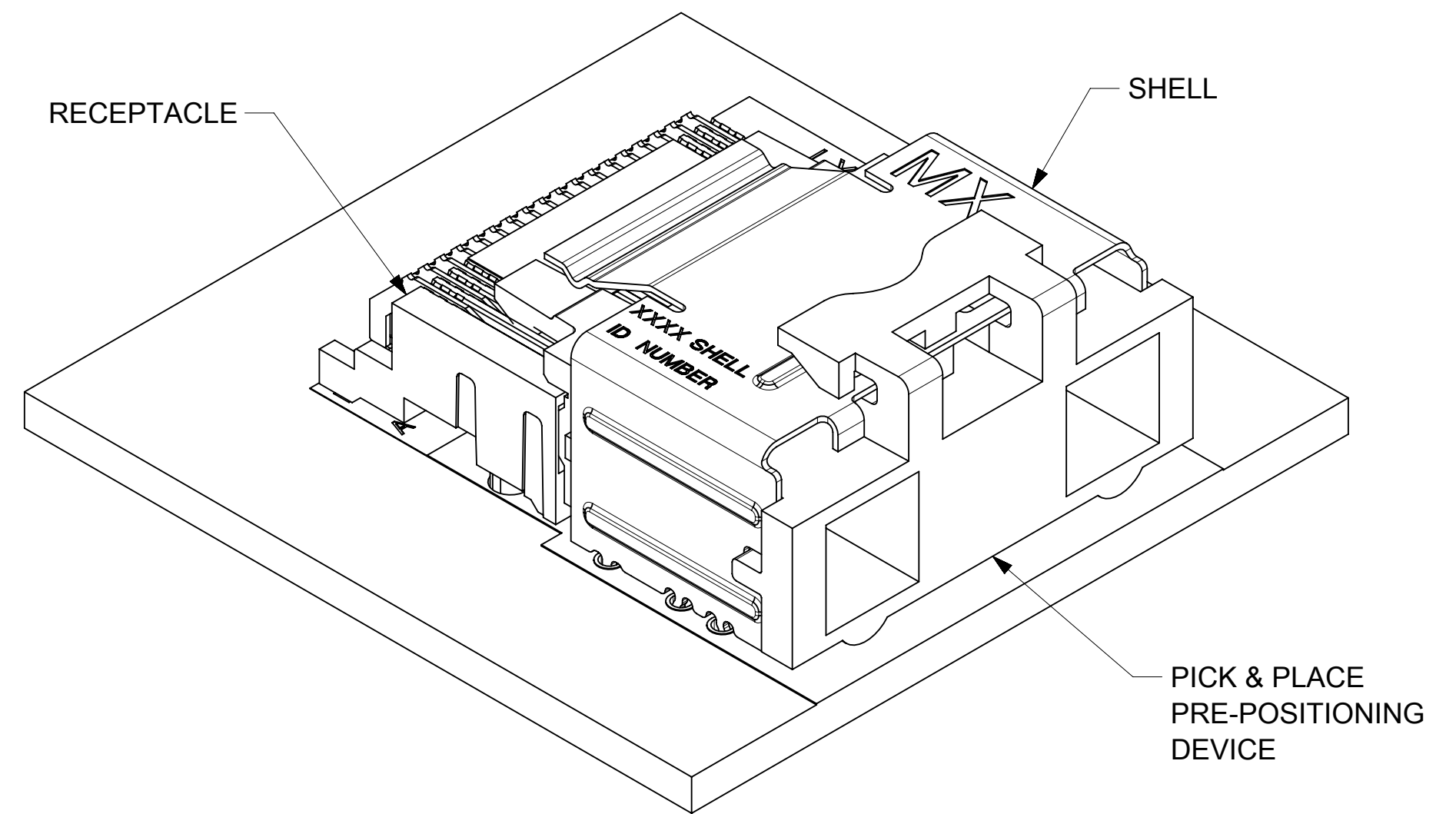
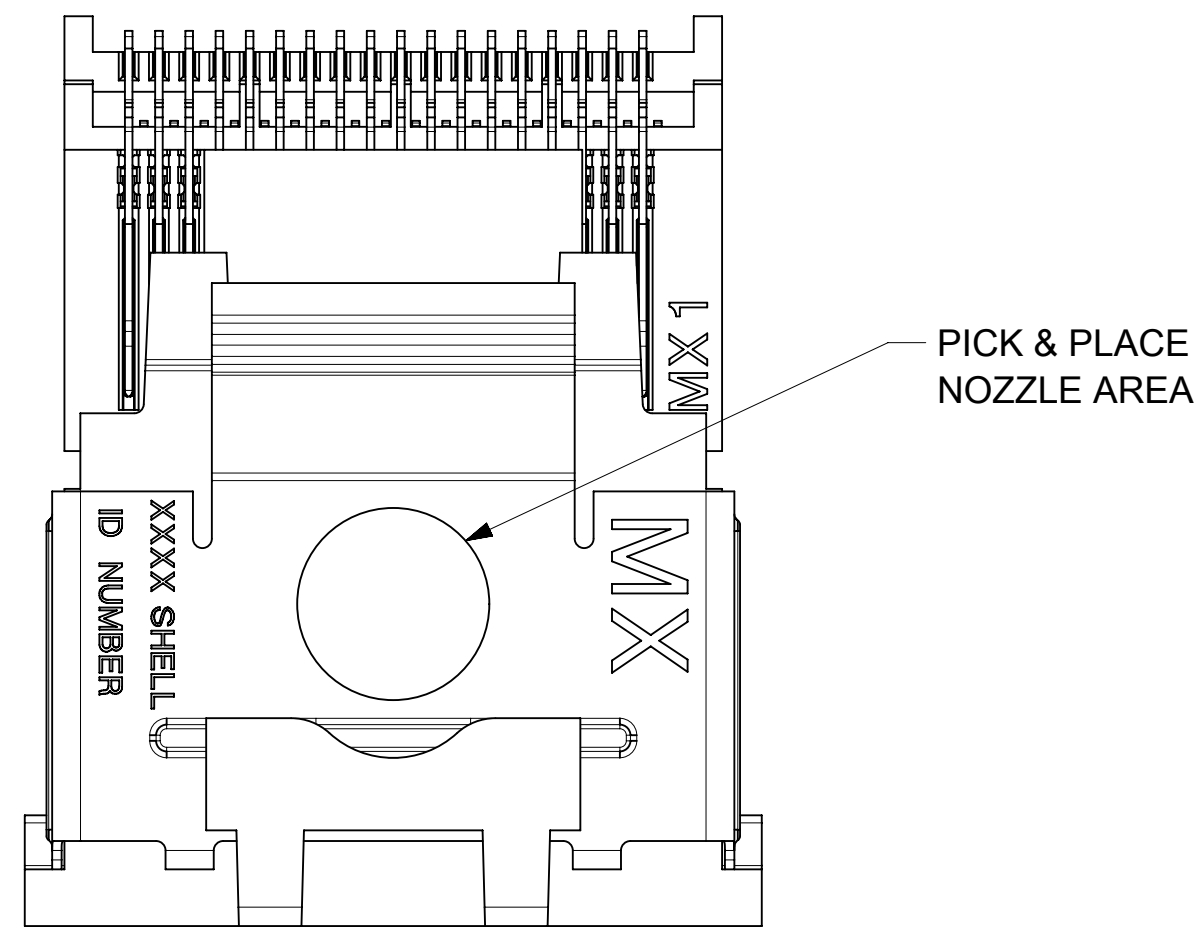

36 CIRCUIT RETENTION-FIT SHELL OPTION SHOWN

NOTES:

1. PICK AND PLACE AREA DEFINED IN APPLICATION SPECIFICATION, AS-75783-001
2. PACKAGING CONSISTS OF CONNECTOR AND SHELL WITH A PRE-POSITIONING PICK AND PLACE DEVICE THAT ARE PACKAGED IN "TAPE AND REEL" FOR ROBOTIC PICK AND PLACE.

| CIRCUIT SIZE | DIM 'D' |
|--------------|---------|
| 26 | 15.50 |
| 36 | 19.50 |
| 50 | 25.10 |
| 68 | 32.30 |

| | | | |
|---------|---|-------|---|
| SYMBOLS | THIS DRAWING CONTAINS INFORMATION THAT IS PROPRIETARY TO MOLEX ELECTRONIC TECHNOLOGIES, LLC AND SHOULD NOT BE USED WITHOUT WRITTEN PERMISSION | | |
| | DIMENSION UNITS | SCALE | CURRENT REV DESC: OBSOLETE PART NO |
| ▽ = 0 | mm | 5:1 | molex I-PASS R/A CONNECTOR INTERNAL ASSY W/SHELL 0.8MM PITCH I/O |
| ▽ = 0 | GENERAL TOLERANCES (UNLESS SPECIFIED) | | |
| ▽ = 0 | ANGULAR TOL ± 0.5° | | EC NO: 696749 DRWN: MUM 2019/03/27 CHK'D: GB 2019/11/06 APPR: JKACHLIC 2022/02/23 |
| ▽ = 0 | 4 PLACES ± | | INITIAL REVISION: DRWN: KLANG 2005/04/15 APPR: RNELSON 2005/04/18 |
| ▽ = 0 | 3 PLACES ± | | |
| ▽ = 0 | 2 PLACES ± 0.13 | | PRODUCT CUSTOMER DRAWING DOCUMENT NUMBER: SD-75783-001 DOC TYPE: PSD DOC PART: 001 REVISION: F1 |
| ▽ = 0 | 1 PLACE ± 0.25 | | MATERIAL NUMBER: SEE TABLE CUSTOMER: GENERAL MARKET SHEET NUMBER: 5 OF 13 |
| ▽ = 0 | 0 PLACES ± | | |
| ▽ = 0 | DRAFT WHERE APPLICABLE MUST REMAIN WITHIN DIMENSIONS | | THIRD ANGLE PROJECTION DRAWING: C-SIZE SERIES: 75783 |

SHELL PCB INTERFACE

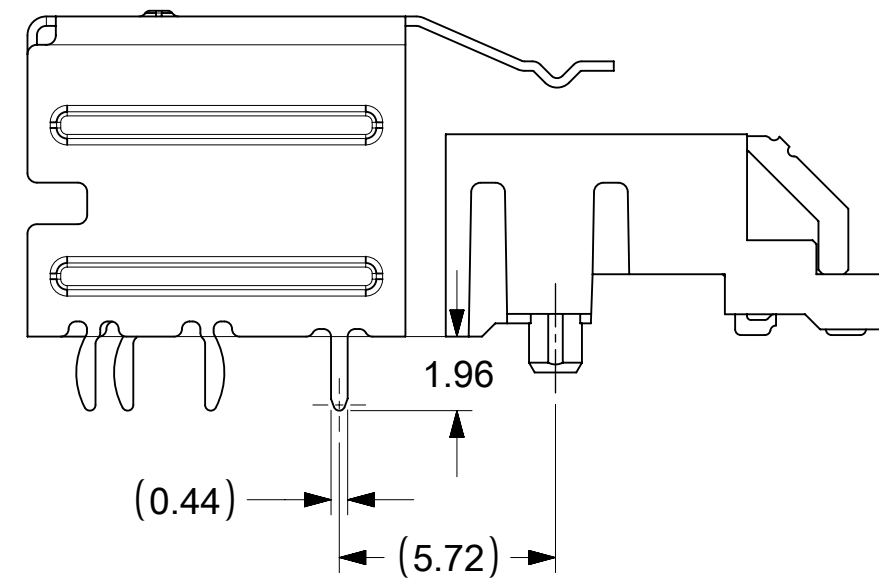
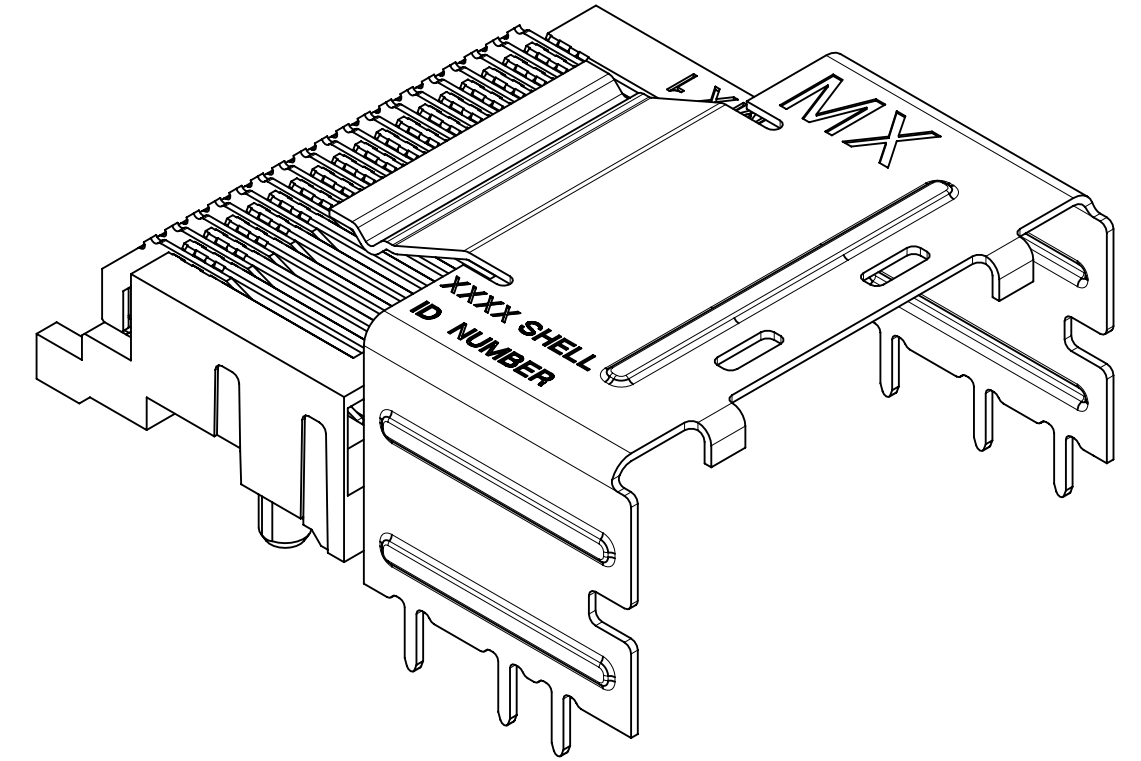
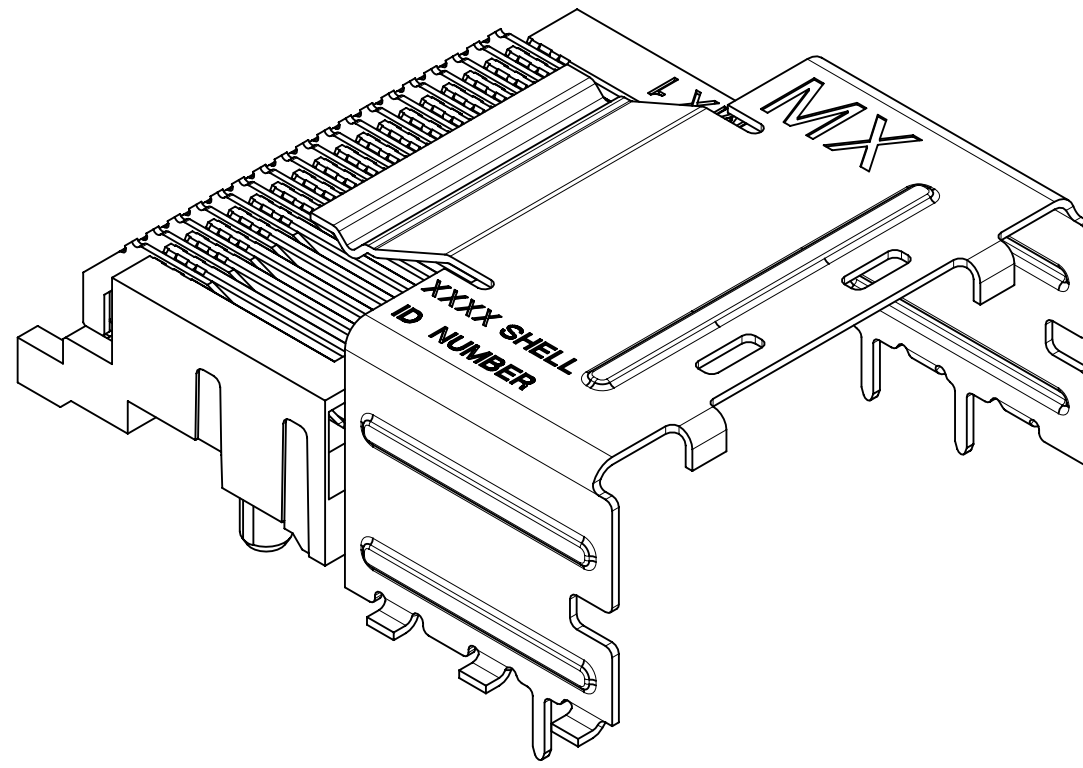
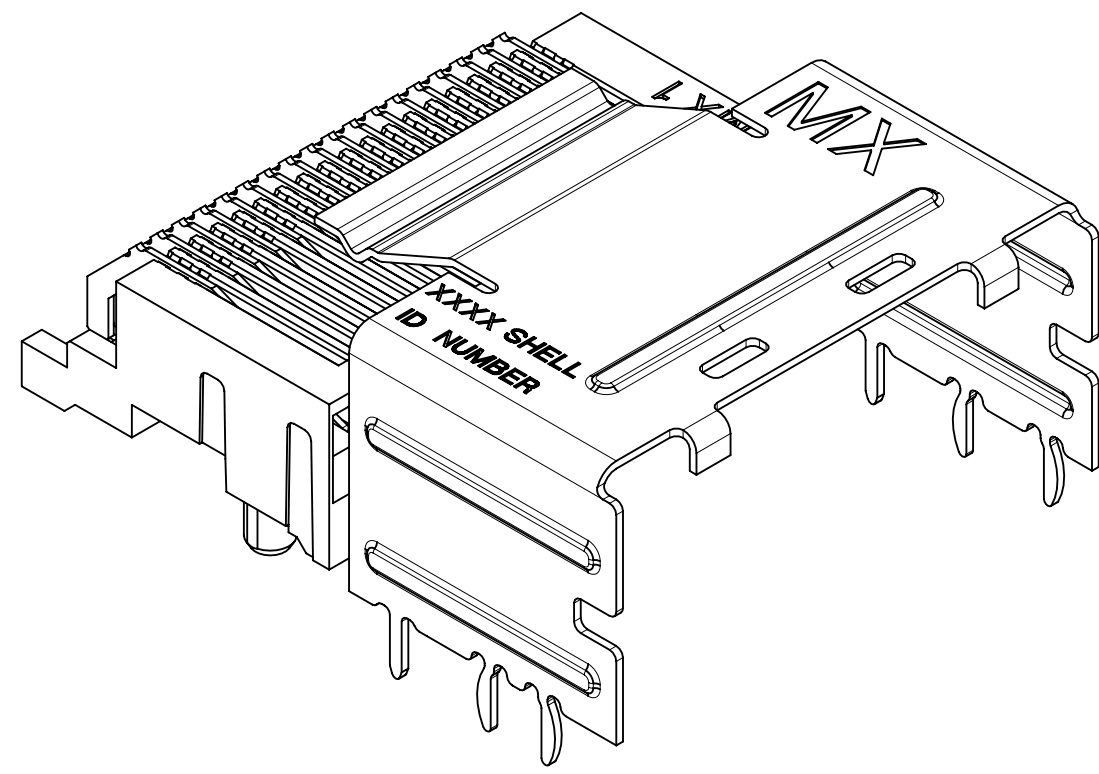

RETENTION-FIT SHELL OPTION

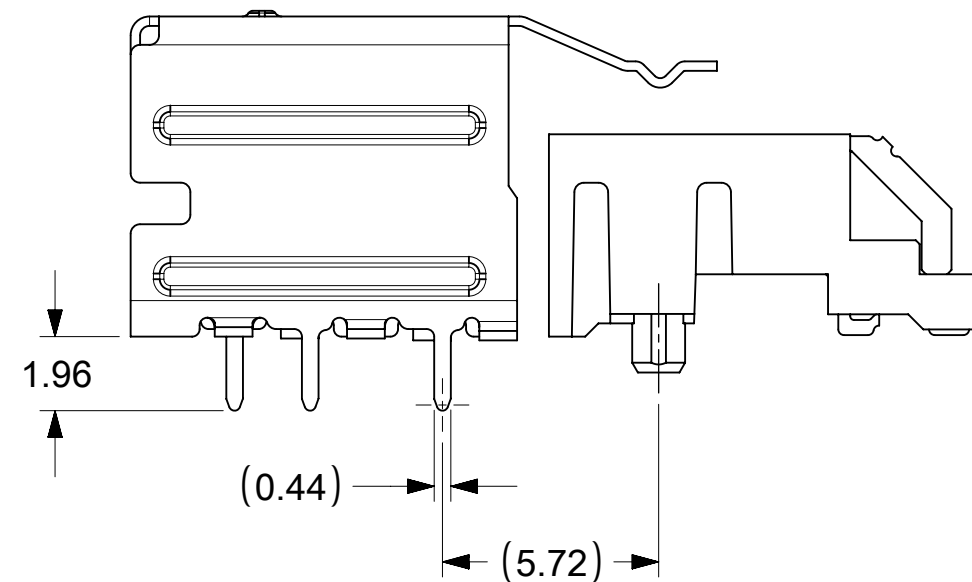

SMT SHELL OPTION

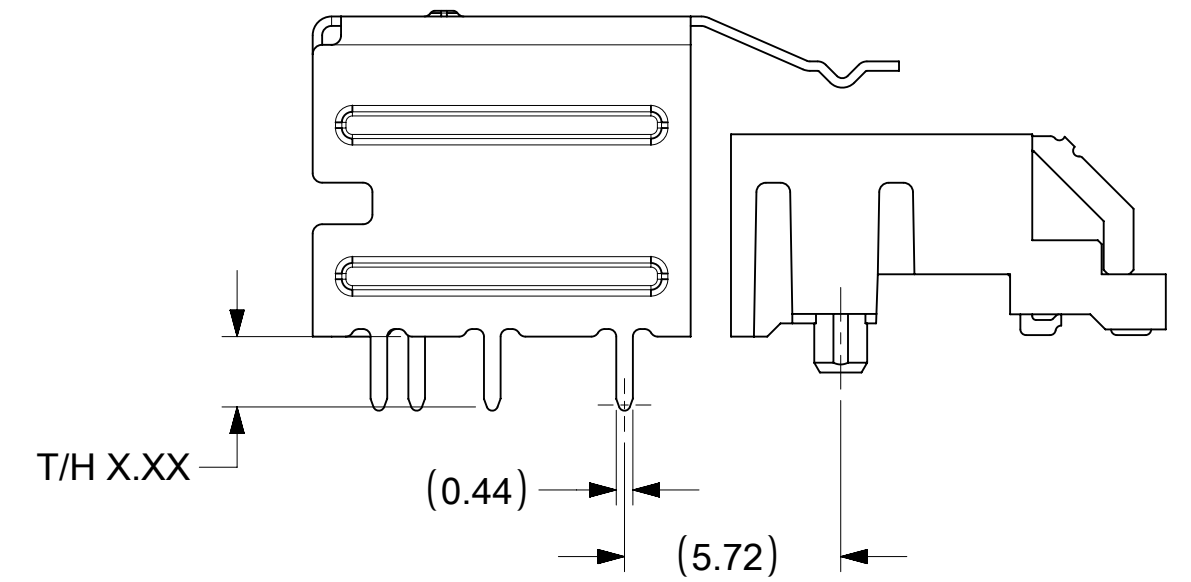

THRU-HOLE SHELL OPTION
SEE TABLE FOR LENGTH
(X.XX DENOTES TAIL LENGTH)

RECOMMENDED PCB THICKNESS FOR SPECIFIED TAIL LENGTH

| TAIL LENGTH | PCB THICKNESS |
|-------------|---------------|
| 1.96 | 1.57(.062) |
| 2.79 | 2.36(.093) |
| 3.18 | 2.79(.110) |
| 3.56 | 3.18(.125) |

NOTE:
RETENTION FIT DENOTES TAILS THAT OFFER RETENTION TO PCB DURING REFLOW PROCESS
SMT DENOTES SURFACE MOUNT TERMINATION
T/H X.XX DENOTES THRU-HOLE TAIL OF LENGTH X.XX

| | | | |
|-----------------|---|----------------|---|
| SYMBOLS | THIS DRAWING CONTAINS INFORMATION THAT IS PROPRIETARY TO MOLEX ELECTRONIC TECHNOLOGIES, LLC AND SHOULD NOT BE USED WITHOUT WRITTEN PERMISSION | | |
| | DIMENSION UNITS | SCALE | CURRENT REV DESC: OBSOLETE PART NO |
| ▽ = 0 | mm | 5:1 | molex I-PASS R/A CONNECTOR INTERNAL ASSY W/SHELL 0.8MM PITCH I/O |
| ▽ = 0 | GENERAL TOLERANCES (UNLESS SPECIFIED) | | |
| ▽ = 0 | ANGULAR TOL ± 0.5° | | EC NO: 696749 |
| ▽ = 0 | 4 PLACES ± | | DRWN: MUM 2019/03/27 |
| ▽ = 0 | 3 PLACES ± | | CHK'D: GB 2019/11/06 |
| ▽ = 0 | 2 PLACES ± 0.13 | | APPR: JKACHLIC 2022/02/23 |
| ▽ = 0 | 1 PLACE ± 0.25 | | INITIAL REVISION: |
| ⊠ = 0 | 0 PLACES ± | | DRWN: KLANG 2005/04/15 |
| ■ = 0 | DRAFT WHERE APPLICABLE MUST REMAIN WITHIN DIMENSIONS | | APPR: RNELSON 2005/04/18 |
| ▽ = 0 | THIRD ANGLE PROJECTION | DRAWING | SERIES |
| | | C-SIZE | 75783 |
| DOCUMENT NUMBER | | DOC TYPE | DOC PART |
| SD-75783-001 | | PSD | 001 |
| MATERIAL NUMBER | | CUSTOMER | SHEET NUMBER |
| SEE TABLE | | GENERAL MARKET | 6 OF 13 |

KEYING OPTIONS

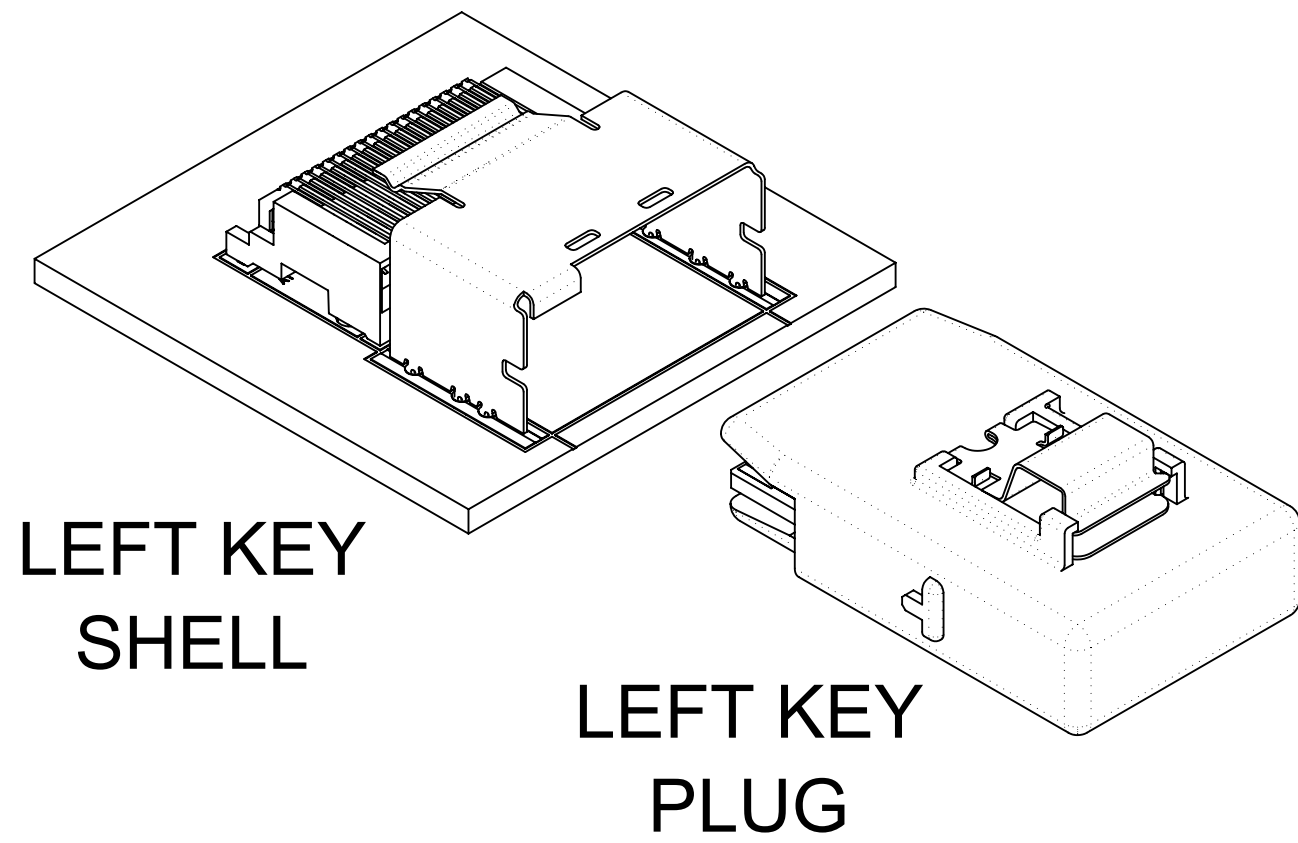

LEFT KEY SHELL

LEFT KEY PLUG

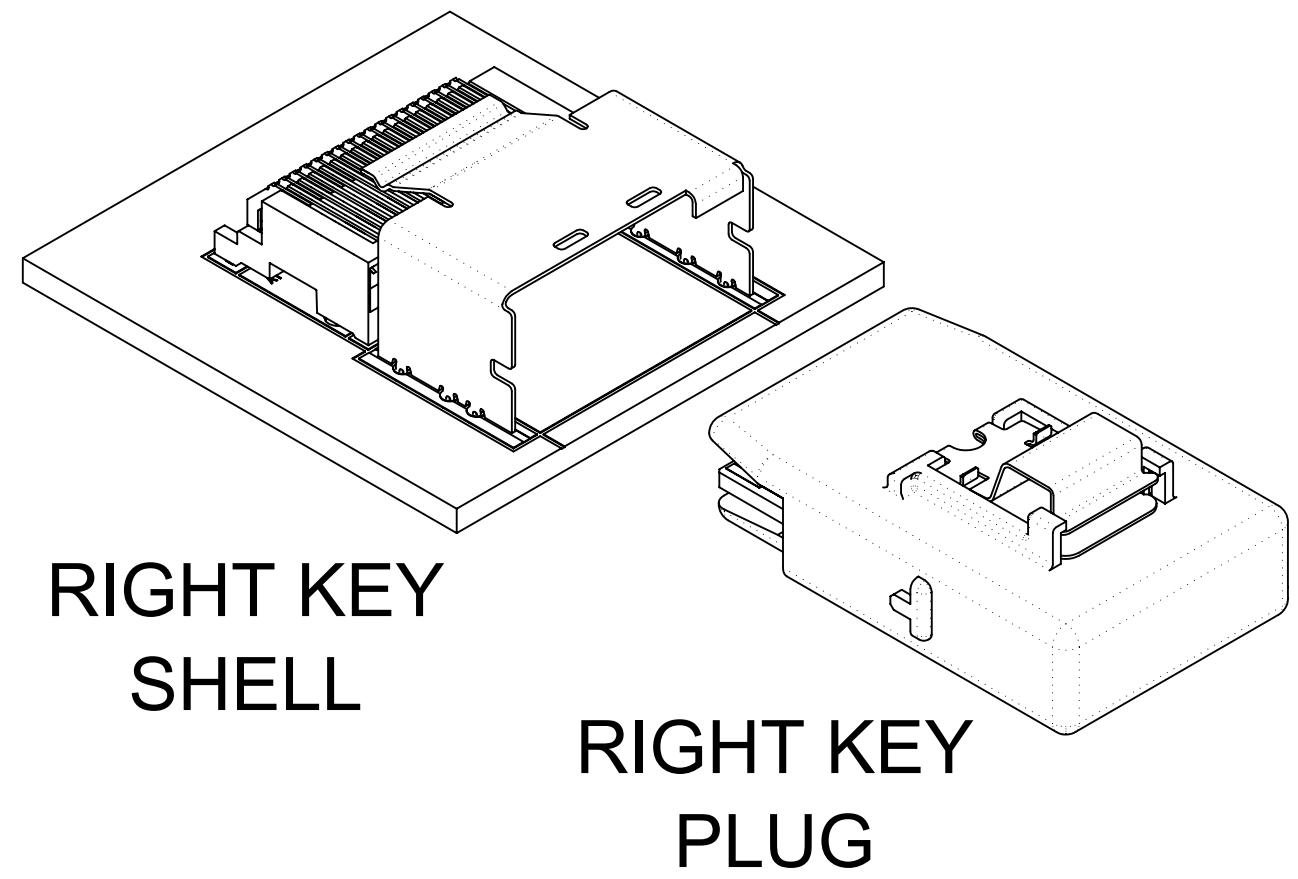

RIGHT KEY SHELL

RIGHT KEY PLUG

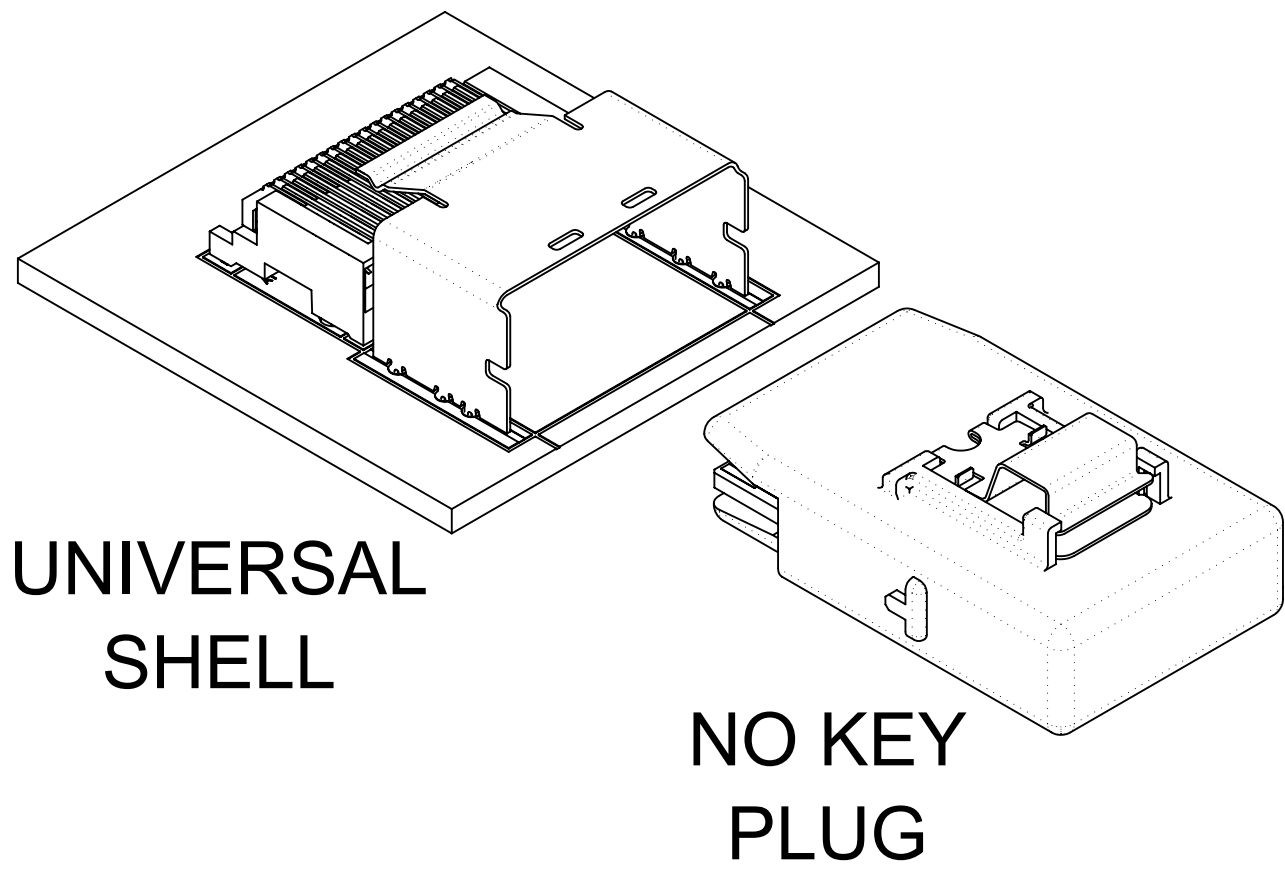

UNIVERSAL SHELL

NO KEY PLUG

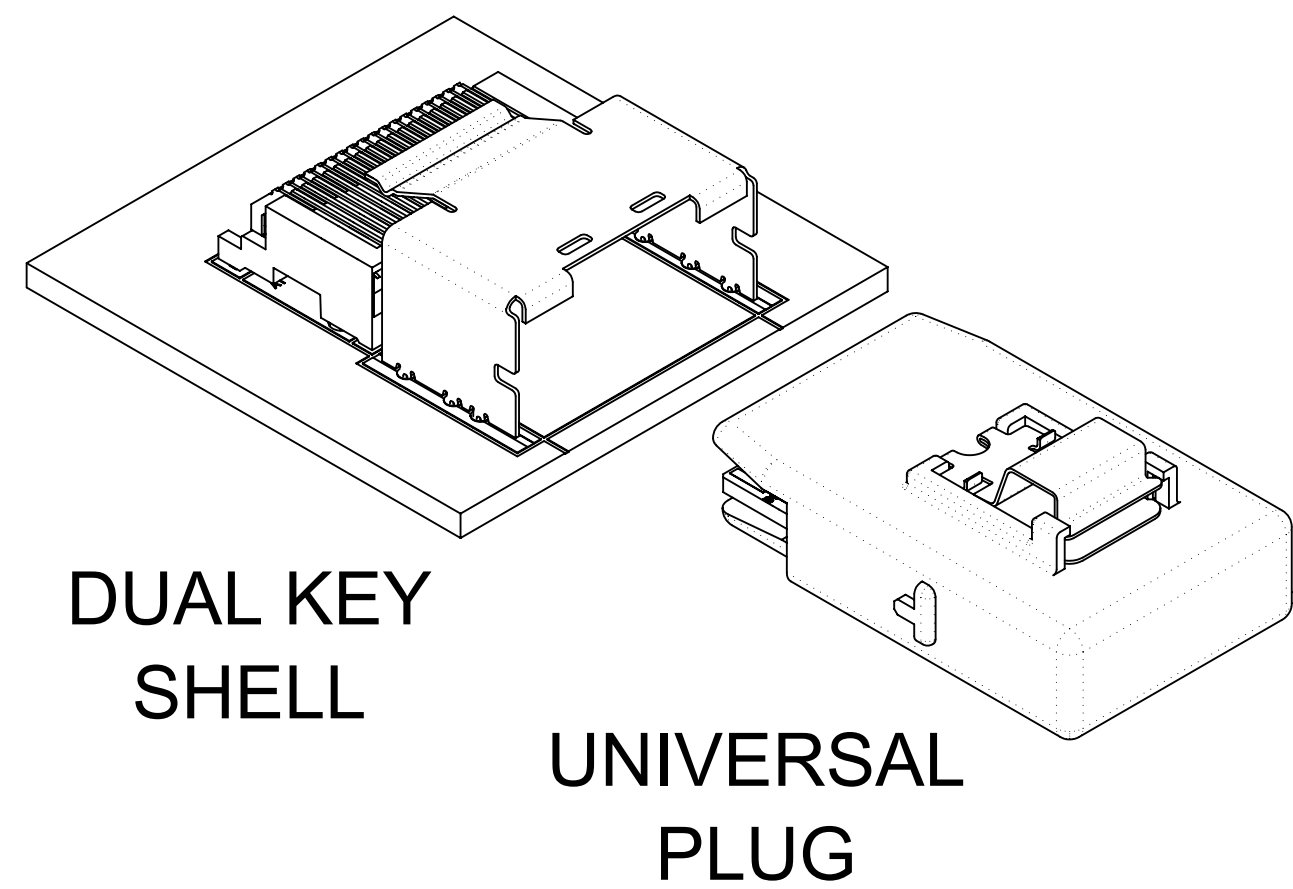

DUAL KEY SHELL

UNIVERSAL PLUG

| | UNIVERSAL SHELL | LEFT KEY SHELL | RIGHT KEY SHELL | DUAL KEY SHELL |
|----------------|-----------------|----------------|-----------------|----------------|
| NO KEY PLUG | YES | NO | NO | NO |
| LEFT KEY PLUG | YES | YES | NO | NO |
| RIGHT KEY PLUG | YES | NO | YES | NO |
| UNIVERSAL PLUG | YES | YES | YES | YES |

| THIS DRAWING CONTAINS INFORMATION THAT IS PROPRIETARY TO MOLEX ELECTRONIC TECHNOLOGIES, LLC AND SHOULD NOT BE USED WITHOUT WRITTEN PERMISSION | | | | | | | | | | | | | | | | |
|---|---------------------------------------|-------|--|--|--|--|--|--|--|---|--|--|--|--|--|--|
| SYMBOLS | DIMENSION UNITS | SCALE | CURRENT REV DESC: OBSOLETE PART NO | | | | | | | | | | | | | |
| ▽ = 0 | mm | 1:1 | molex I-PASS R/A CONNECTOR INTERNAL ASSY W/SHELL 0.8MM PITCH I/O PRODUCT CUSTOMER DRAWING | | | | | | | | | | | | | |
| ▽ = 0 | GENERAL TOLERANCES (UNLESS SPECIFIED) | | | | | | | | | EC NO: 696749 DRWN: MUM CHK'D: GB APPR: JKACHLIC | | | | | | |
| ▽ = 0 | ANGULAR TOL ± 0.5° | | | | | | | | | 2019/03/27 2019/11/06 2022/02/23 | | | | | | |
| ▽ = 0 | 4 PLACES ± | | | | | | | | | INITIAL REVISION: DRWN: KLANG APPR: RNELSON | | | | | | |
| ▽ = 0 | 3 PLACES ± | | 2005/04/15 2005/04/18 | | | | | | | | | | | | | |
| ▽ = 0 | 2 PLACES ± 0.13 | | DOCUMENT NUMBER: SD-75783-001 DOC TYPE: PSD DOC PART: 001 REVISION: F1 | | | | | | | | | | | | | |
| ▽ = 0 | 1 PLACE ± 0.25 | | MATERIAL NUMBER: SEE TABLE CUSTOMER: GENERAL MARKET SHEET NUMBER: 7 OF 13 | | | | | | | | | | | | | |
| ▽ = 0 | 0 PLACES ± | | DRAFT WHERE APPLICABLE MUST REMAIN WITHIN DIMENSIONS THIRD ANGLE PROJECTION DRAWING: C-SIZE SERIES: 75783 | | | | | | | | | | | | | |

26 CIRCUIT ITEM NUMBERS

| CIRCUIT SIZE | ITEM NUMBER | PLATING OPTION | SHELL PCB OPTION | SHELL KEY OPTION |
|--------------|-------------|----------------|------------------|------------------|
| 26 | 75783-0007 | OPTION 1 | RETENTION | LEFT |
| 26 | 75783-0008 | OPTION 1 | RETENTION | RIGHT |
| 26 | 75783-0009 | OPTION 1 | RETENTION | DUAL |
| 26 | 75783-0010 | OPTION 1 | SMT | LEFT |
| 26 | 75783-0011 | OPTION 1 | SMT | RIGHT |
| 26 | 75783-0012 | OPTION 1 | SMT | DUAL |
| 26 | 75783-0019 | OPTION 2 | RETENTION | LEFT |
| 26 | 75783-0020 | OPTION 2 | RETENTION | RIGHT |
| 26 | 75783-0021 | OPTION 2 | RETENTION | DUAL |
| 26 | 75783-0022 | OPTION 2 | SMT | LEFT |
| 26 | 75783-0023 | OPTION 2 | SMT | RIGHT |
| 26 | 75783-0024 | OPTION 2 | SMT | DUAL |
| 26 | 75783-0025 | OPTION 1 | RETENTION | UNIVERSAL |
| 26 | 75783-0026 | OPTION 1 | SMT | UNIVERSAL |
| 26 | 75783-0027 | OPTION 2 | RETENTION | UNIVERSAL |
| 26 | 75783-0028 | OPTION 2 | SMT | UNIVERSAL |
| 26 | 75783-0029 | OPTION 1 | T/H 1.96 | LEFT |
| 26 | 75783-0030 | OPTION 1 | T/H 1.96 | RIGHT |
| 26 | 75783-0031 | OPTION 1 | T/H 1.96 | DUAL |
| 26 | 75783-0032 | OPTION 1 | T/H 1.96 | UNIVERSAL |
| 26 | 75783-0033 | OPTION 2 | T/H 1.96 | LEFT |
| 26 | 75783-0034 | OPTION 2 | T/H 1.96 | RIGHT |
| 26 | 75783-0035 | OPTION 2 | T/H 1.96 | DUAL |
| 26 | 75783-0036 | OPTION 2 | T/H 1.96 | UNIVERSAL |

| CIRCUIT SIZE | ITEM NUMBER | PLATING OPTION | SHELL PCB OPTION | SHELL KEY OPTION |
|--------------|-------------|----------------|------------------|------------------|
| 26 | 75783-0037 | OPTION 1 | T/H 2.79 | LEFT |
| 26 | 75783-0038 | OPTION 1 | T/H 2.79 | RIGHT |
| 26 | 75783-0039 | OPTION 1 | T/H 2.79 | DUAL |
| 26 | 75783-0040 | OPTION 1 | T/H 2.79 | UNIVERSAL |
| 26 | 75783-0041 | OPTION 2 | T/H 2.79 | LEFT |
| 26 | 75783-0042 | OPTION 2 | T/H 2.79 | RIGHT |
| 26 | 75783-0043 | OPTION 2 | T/H 2.79 | DUAL |
| 26 | 75783-0044 | OPTION 2 | T/H 2.79 | UNIVERSAL |
| 26 | 75783-0045 | OPTION 1 | T/H 3.18 | LEFT |
| 26 | 75783-0046 | OPTION 1 | T/H 3.18 | RIGHT |
| 26 | 75783-0047 | OPTION 1 | T/H 3.18 | DUAL |
| 26 | 75783-0048 | OPTION 1 | T/H 3.18 | UNIVERSAL |
| 26 | 75783-0049 | OPTION 2 | T/H 3.18 | LEFT |
| 26 | 75783-0050 | OPTION 2 | T/H 3.18 | RIGHT |
| 26 | 75783-0051 | OPTION 2 | T/H 3.18 | DUAL |

| | | | | |
|---|---|------------------------|------------------------------------|--------------|
| SYMBOLS = 0 = 0 = 0 = 0 = 0 = 0 = 0 = 0 = 0 | THIS DRAWING CONTAINS INFORMATION THAT IS PROPRIETARY TO MOLEX ELECTRONIC TECHNOLOGIES, LLC AND SHOULD NOT BE USED WITHOUT WRITTEN PERMISSION | | | |
| | DIMENSION UNITS | SCALE | CURRENT REV DESC: OBSOLETE PART NO | |
| | mm | 1:1 | | |
| | GENERAL TOLERANCES (UNLESS SPECIFIED) | | EC NO: 696749 | |
| | ANGULAR TOL ± 0.5° | | DRWN: MUM | 2019/03/27 |
| | 4 PLACES ± | | CHK'D: GB | 2019/11/06 |
| | 3 PLACES ± | | APPR: JKACHLIC | 2022/02/23 |
| | 2 PLACES ± 0.13 | | INITIAL REVISION: | |
| | 1 PLACE ± 0.25 | | DRWN: KLANG | 2005/04/15 |
| | 0 PLACES ± | | APPR: RNELSON | 2005/04/18 |
| DRAFT WHERE APPLICABLE MUST REMAIN WITHIN DIMENSIONS | | THIRD ANGLE PROJECTION | DRAWING | SERIES |
| | | | C-SIZE | 75783 |
| DOCUMENT STATUS | | DOC TYPE | DOC PART | REVISION |
| P1 | RELEASE DATE | PSD | 001 | F1 |
| 2022/02/23 | 04:11:32 | MATERIAL NUMBER | | SHEET NUMBER |
| SEE TABLE | | CUSTOMER | | 8 OF 13 |
| | | GENERAL MARKET | | |

molex

I-PASS R/A CONNECTOR
INTERNAL ASSY W/SHELL 0.8MM PITCH I/O

PRODUCT CUSTOMER DRAWING

DOCUMENT NUMBER: SD-75783-001
DOC TYPE: PSD
DOC PART: 001
REVISION: F1

MATERIAL NUMBER: SEE TABLE
CUSTOMER: GENERAL MARKET
SHEET NUMBER: 8 OF 13

36 CIRCUIT ITEM NUMBERS

| CIRCUIT SIZE | ITEM NUMBER | PLATING OPTION | SHELL PCB OPTION | SHELL KEY OPTION |
|--------------|-------------|----------------|------------------|------------------|
| 36 | 75783-0107 | OPTION 1 | RETENTION | LEFT |
| 36 | 75783-0108 | OPTION 1 | RETENTION | RIGHT |
| 36 | 75783-0109 | OPTION 1 | RETENTION | DUAL |
| 36 | 75783-0110 | OPTION 1 | SMT | LEFT |
| 36 | 75783-0111 | OPTION 1 | SMT | RIGHT |
| 36 | 75783-0112 | OPTION 1 | SMT | DUAL |
| 36 | 75783-0119 | OPTION 2 | RETENTION | LEFT |
| 36 | 75783-0120 | OPTION 2 | RETENTION | RIGHT |
| 36 | 75783-0121 | OPTION 2 | RETENTION | DUAL |
| 36 | 75783-0122 | OPTION 2 | SMT | LEFT |
| 36 | 75783-0123 | OPTION 2 | SMT | RIGHT |
| 36 | 75783-0124 | OPTION 2 | SMT | DUAL |
| 36 | 75783-0125 | OPTION 1 | RETENTION | UNIVERSAL |
| 36 | 75783-0126 | OPTION 1 | SMT | UNIVERSAL |
| 36 | 75783-0127 | OPTION 2 | RETENTION | UNIVERSAL |
| 36 | 75783-0128 | OPTION 2 | SMT | UNIVERSAL |
| 36 | 75783-0129 | OPTION 1 | T/H 1.96 | LEFT |
| 36 | 75783-0130 | OPTION 1 | T/H 1.96 | RIGHT |
| 36 | 75783-0131 | OPTION 1 | T/H 1.96 | DUAL |
| 36 | 75783-0132 | OPTION 1 | T/H 1.96 | UNIVERSAL |
| 36 | 75783-0133 | OPTION 2 | T/H 1.96 | LEFT |
| 36 | 75783-0134 | OPTION 2 | T/H 1.96 | RIGHT |
| 36 | 75783-0135 | OPTION 2 | T/H 1.96 | DUAL |
| 36 | 75783-0136 | OPTION 2 | T/H 1.96 | UNIVERSAL |
| 36 | 75783-0170 | OPTION 1 | T/H 1.40 | UNIVERSAL |

| CIRCUIT SIZE | ITEM NUMBER | PLATING OPTION | SHELL PCB OPTION | SHELL KEY OPTION |
|--------------|-------------|----------------|------------------|------------------|
| 36 | 75783-0137 | OPTION 1 | T/H 2.79 | LEFT |
| 36 | 75783-0138 | OPTION 1 | T/H 2.79 | RIGHT |
| 36 | 75783-0139 | OPTION 1 | T/H 2.79 | DUAL |
| 36 | 75783-0140 | OPTION 1 | T/H 2.79 | UNIVERSAL |
| 36 | 75783-0141 | OPTION 2 | T/H 2.79 | LEFT |
| 36 | 75783-0142 | OPTION 2 | T/H 2.79 | RIGHT |
| 36 | 75783-0143 | OPTION 2 | T/H 2.79 | DUAL |
| 36 | 75783-0144 | OPTION 2 | T/H 2.79 | UNIVERSAL |
| 36 | 75783-0147 | OPTION 1 | T/H 3.18 | DUAL |
| 36 | 75783-0148 | OPTION 1 | T/H 3.18 | UNIVERSAL |
| 36 | 75783-0149 | OPTION 2 | T/H 3.18 | LEFT |
| 36 | 75783-0150 | OPTION 2 | T/H 3.18 | RIGHT |
| 36 | 75783-0151 | OPTION 2 | T/H 3.18 | DUAL |
| 36 | 75783-0152 | OPTION 2 | T/H 3.18 | UNIVERSAL |
| 36 | 75783-0153 | OPTION 1 | T/H 3.56 | LEFT |
| 36 | 75783-0154 | OPTION 1 | T/H 3.56 | RIGHT |
| 36 | 75783-0155 | OPTION 1 | T/H 3.56 | DUAL |
| 36 | 75783-0156 | OPTION 1 | T/H 3.56 | UNIVERSAL |
| 36 | 75783-0157 | OPTION 2 | T/H 3.56 | LEFT |
| 36 | 75783-0158 | OPTION 2 | T/H 3.56 | RIGHT |
| 36 | 75783-0159 | OPTION 2 | T/H 3.56 | DUAL |
| 36 | 75783-0160 | OPTION 2 | T/H 3.56 | UNIVERSAL |

| | | | | | | | | |
|---|---|------------------------|------------------------------------|------------|-----------------|----------------|----------|--------------|
| SYMBOLS = 0 = 0 = 0 = 0 = 0 = 0 = 0 = 0 = 0 | THIS DRAWING CONTAINS INFORMATION THAT IS PROPRIETARY TO MOLEX ELECTRONIC TECHNOLOGIES, LLC AND SHOULD NOT BE USED WITHOUT WRITTEN PERMISSION | | | | | | | |
| | DIMENSION UNITS | SCALE | CURRENT REV DESC: OBSOLETE PART NO | | | | | |
| | mm | 1:1 | | | | | | |
| | GENERAL TOLERANCES (UNLESS SPECIFIED) | | EC NO: 696749 | | | | | |
| | ANGULAR TOL ± 0.5° | | DRWN: MUM | 2019/03/27 | | | | |
| | 4 PLACES ± | | CHK'D: GB | 2019/11/06 | | | | |
| | 3 PLACES ± | | APPR: JKACHLIC | 2022/02/23 | | | | |
| | 2 PLACES ± 0.13 | | INITIAL REVISION: | | | | | |
| | 1 PLACE ± 0.25 | | DRWN: KLANG | 2005/04/15 | | | | |
| | 0 PLACES ± | | APPR: RNELSON | 2005/04/18 | | | | |
| DRAFT WHERE APPLICABLE MUST REMAIN WITHIN DIMENSIONS | | THIRD ANGLE PROJECTION | DRAWING | SERIES | DOCUMENT NUMBER | DOC TYPE | DOC PART | REVISION |
| | | | C-SIZE | 75783 | SD-75783-001 | PSD | 001 | F1 |
| | | | | | MATERIAL NUMBER | CUSTOMER | | SHEET NUMBER |
| | | | | | SEE TABLE | GENERAL MARKET | | 9 OF 13 |











I-PASS R/A CONNECTOR
INTERNAL ASSY W/SHELL 0.8MM PITCH I/O

PRODUCT CUSTOMER DRAWING

50 CIRCUIT ITEM NUMBERS

| CIRCUIT SIZE | ITEM NUMBER | PLATING OPTION | SHELL PCB OPTION | SHELL KEY OPTION |
|--------------|-------------|----------------|------------------|------------------|
| 50 | 75783-0207 | OPTION 1 | RETENTION | LEFT |
| 50 | 75783-0208 | OPTION 1 | RETENTION | RIGHT |
| 50 | 75783-0209 | OPTION 1 | RETENTION | DUAL |
| 50 | 75783-0210 | OPTION 1 | SMT | LEFT |
| 50 | 75783-0211 | OPTION 1 | SMT | RIGHT |
| 50 | 75783-0212 | OPTION 1 | SMT | DUAL |
| 50 | 75783-0219 | OPTION 2 | RETENTION | LEFT |
| 50 | 75783-0220 | OPTION 2 | RETENTION | RIGHT |
| 50 | 75783-0221 | OPTION 2 | RETENTION | DUAL |
| 50 | 75783-0222 | OPTION 2 | SMT | LEFT |
| 50 | 75783-0223 | OPTION 2 | SMT | RIGHT |
| 50 | 75783-0224 | OPTION 2 | SMT | DUAL |
| 50 | 75783-0225 | OPTION 1 | RETENTION | UNIVERSAL |
| 50 | 75783-0226 | OPTION 1 | SMT | UNIVERSAL |
| 50 | 75783-0227 | OPTION 2 | RETENTION | UNIVERSAL |
| 50 | 75783-0228 | OPTION 2 | SMT | UNIVERSAL |
| 50 | 75783-0229 | OPTION 1 | T/H 1.96 | LEFT |
| 50 | 75783-0230 | OPTION 1 | T/H 1.96 | RIGHT |
| 50 | 75783-0231 | OPTION 1 | T/H 1.96 | DUAL |
| 50 | 75783-0232 | OPTION 1 | T/H 1.96 | UNIVERSAL |
| 50 | 75783-0233 | OPTION 2 | T/H 1.96 | LEFT |
| 50 | 75783-0234 | OPTION 2 | T/H 1.96 | RIGHT |
| 50 | 75783-0235 | OPTION 2 | T/H 1.96 | DUAL |
| 50 | 75783-0236 | OPTION 2 | T/H 1.96 | UNIVERSAL |

| CIRCUIT SIZE | ITEM NUMBER | PLATING OPTION | SHELL PCB OPTION | SHELL KEY OPTION |
|--------------|-------------|----------------|------------------|------------------|
| 50 | 75783-0237 | OPTION 1 | T/H 2.79 | LEFT |
| 50 | 75783-0238 | OPTION 1 | T/H 2.79 | RIGHT |
| 50 | 75783-0239 | OPTION 1 | T/H 2.79 | DUAL |
| 50 | 75783-0240 | OPTION 1 | T/H 2.79 | UNIVERSAL |
| 50 | 75783-0241 | OPTION 2 | T/H 2.79 | LEFT |
| 50 | 75783-0242 | OPTION 2 | T/H 2.79 | RIGHT |
| 50 | 75783-0243 | OPTION 2 | T/H 2.79 | DUAL |
| 50 | 75783-0244 | OPTION 2 | T/H 2.79 | UNIVERSAL |
| 50 | 75783-0245 | OPTION 1 | T/H 3.18 | LEFT |
| 50 | 75783-0246 | OPTION 1 | T/H 3.18 | RIGHT |
| 50 | 75783-0247 | OPTION 1 | T/H 3.18 | DUAL |
| 50 | 75783-0248 | OPTION 1 | T/H 3.18 | UNIVERSAL |
| 50 | 75783-0249 | OPTION 2 | T/H 3.18 | LEFT |
| 50 | 75783-0250 | OPTION 2 | T/H 3.18 | RIGHT |
| 50 | 75783-0251 | OPTION 2 | T/H 3.18 | DUAL |
| 50 | 75783-0252 | OPTION 2 | T/H 3.18 | UNIVERSAL |

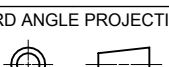
| | | | | | | | | | | | | |
|---|---|--|----------------------------|--|-------------------|--|---|--|---------|--|--------|--|
| SYMBOLS  = 0  = 0  = 0  = 0  = 0  = 0  = 0  = 0  = 0 | THIS DRAWING CONTAINS INFORMATION THAT IS PROPRIETARY TO MOLEX ELECTRONIC TECHNOLOGIES, LLC AND SHOULD NOT BE USED WITHOUT WRITTEN PERMISSION | | DIMENSION UNITS: mm | | SCALE: 1:1 | | CURRENT REV DESC: OBSOLETE PART NO | | | | | |
| | GENERAL TOLERANCES (UNLESS SPECIFIED) | | | | | | EC NO: 696749 | | | | | |
| | ANGULAR TOL ± 0.5° | | | | | | DRWN: MUM 2019/03/27 | | | | | |
| | 4 PLACES ± | | | | | | CHK'D: GB 2019/11/06 | | | | | |
| | 3 PLACES ± | | | | | | APPR: JKACHLIC 2022/02/23 | | | | | |
| | 2 PLACES ± 0.13 | | | | | | INITIAL REVISION: | | | | | |
| | 1 PLACE ± 0.25 | | | | | | DRWN: KLANG 2005/04/15 | | | | | |
| | 0 PLACES ± | | | | | | APPR: RNELSON 2005/04/18 | | | | | |
| | DRAFT WHERE APPLICABLE MUST REMAIN WITHIN DIMENSIONS | | | | | | THIRD ANGLE PROJECTION | | DRAWING | | SERIES | |
| | | | | | | |  | | C-SIZE | | 75783 | |



I-PASS R/A CONNECTOR
INTERNAL ASSY W/SHELL 0.8MM PITCH I/O

PRODUCT CUSTOMER DRAWING

| | | | |
|---------------------|----------|----------|-----------|
| DOCUMENT NUMBER | DOC TYPE | DOC PART | REVISION |
| SD-75783-001 | PSD | 001 | F1 |

| | | |
|-----------------|----------------|--------------|
| MATERIAL NUMBER | CUSTOMER | SHEET NUMBER |
| SEE TABLE | GENERAL MARKET | 10 OF 13 |

68 CIRCUIT ITEM NUMBERS

| CIRCUIT SIZE | ITEM NUMBER | PLATING OPTION | SHELL PCB OPTION | SHELL KEY OPTION |
|--------------|-------------|----------------|------------------|------------------|
| 68 | 75783-0307 | OPTION 1 | RETENTION | LEFT |
| 68 | 75783-0308 | OPTION 1 | RETENTION | RIGHT |
| 68 | 75783-0309 | OPTION 1 | RETENTION | DUAL |
| 68 | 75783-0310 | OPTION 1 | SMT | LEFT |
| 68 | 75783-0311 | OPTION 1 | SMT | RIGHT |
| 68 | 75783-0312 | OPTION 1 | SMT | DUAL |
| 68 | 75783-0319 | OPTION 2 | RETENTION | LEFT |
| 68 | 75783-0320 | OPTION 2 | RETENTION | RIGHT |
| 68 | 75783-0321 | OPTION 2 | RETENTION | DUAL |
| 68 | 75783-0322 | OPTION 2 | SMT | LEFT |
| 68 | 75783-0323 | OPTION 2 | SMT | RIGHT |
| 68 | 75783-0324 | OPTION 2 | SMT | DUAL |
| 68 | 75783-0325 | OPTION 1 | RETENTION | UNIVERSAL |
| 68 | 75783-0327 | OPTION 2 | RETENTION | UNIVERSAL |
| 68 | 75783-0328 | OPTION 2 | SMT | UNIVERSAL |
| 68 | 75783-0329 | OPTION 1 | T/H 1.96 | LEFT |
| 68 | 75783-0330 | OPTION 1 | T/H 1.96 | RIGHT |
| 68 | 75783-0331 | OPTION 1 | T/H 1.96 | DUAL |
| 68 | 75783-0332 | OPTION 1 | T/H 1.96 | UNIVERSAL |
| 68 | 75783-0333 | OPTION 2 | T/H 1.96 | LEFT |
| 68 | 75783-0334 | OPTION 2 | T/H 1.96 | RIGHT |
| 68 | 75783-0335 | OPTION 2 | T/H 1.96 | DUAL |
| 68 | 75783-0336 | OPTION 2 | T/H 1.96 | UNIVERSAL |

| CIRCUIT SIZE | ITEM NUMBER | PLATING OPTION | SHELL PCB OPTION | SHELL KEY OPTION |
|--------------|-------------|----------------|------------------|------------------|
| 68 | 75783-0337 | OPTION 1 | T/H 2.79 | LEFT |
| 68 | 75783-0338 | OPTION 1 | T/H 2.79 | RIGHT |
| 68 | 75783-0339 | OPTION 1 | T/H 2.79 | DUAL |
| 68 | 75783-0340 | OPTION 1 | T/H 2.79 | UNIVERSAL |
| 68 | 75783-0341 | OPTION 2 | T/H 2.79 | LEFT |
| 68 | 75783-0342 | OPTION 2 | T/H 2.79 | RIGHT |
| 68 | 75783-0343 | OPTION 2 | T/H 2.79 | DUAL |
| 68 | 75783-0344 | OPTION 2 | T/H 2.79 | UNIVERSAL |
| 68 | 75783-0345 | OPTION 1 | T/H 3.18 | LEFT |
| 68 | 75783-0346 | OPTION 1 | T/H 3.18 | RIGHT |
| 68 | 75783-0347 | OPTION 1 | T/H 3.18 | DUAL |
| 68 | 75783-0348 | OPTION 1 | T/H 3.18 | UNIVERSAL |
| 68 | 75783-0349 | OPTION 2 | T/H 3.18 | LEFT |
| 68 | 75783-0350 | OPTION 2 | T/H 3.18 | RIGHT |
| 68 | 75783-0351 | OPTION 2 | T/H 3.18 | DUAL |
| 68 | 75783-0352 | OPTION 2 | T/H 3.18 | UNIVERSAL |

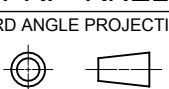
| | | | | | | | | | | | | | | | | | | | |
|--|--|---|--|------------------------------------|--|--------|--|-----------------|--|---|--|---|--|---|--|----------|--|--|--|
| SYMBOLS | | | | | | | | | | THIS DRAWING CONTAINS INFORMATION THAT IS PROPRIETARY TO MOLEX ELECTRONIC TECHNOLOGIES, LLC AND SHOULD NOT BE USED WITHOUT WRITTEN PERMISSION | | | | | | | | | |
| DIMENSION UNITS | | SCALE | | CURRENT REV DESC: OBSOLETE PART NO | | | | | | | | | |  | | | | | |
| mm | | 1:1 | | | | | | | | | | | | | | | | | |
| GENERAL TOLERANCES (UNLESS SPECIFIED) | | EC NO: 696749 | | | | | | | | | | I-PASS R/A CONNECTOR INTERNAL ASSY W/SHELL 0.8MM PITCH I/O | | | | | | | |
| ANGULAR TOL ± 0.5° | | DRWN: MUM 2019/03/27 | | | | | | | | | | | | | | | | | |
| 4 PLACES ± | | CHK'D: GB 2019/11/06 | | | | | | | | | | PRODUCT CUSTOMER DRAWING | | | | | | | |
| 3 PLACES ± | | APPR: JKACHLIC 2022/02/23 | | | | | | | | | | | | | | | | | |
| 2 PLACES ± 0.13 | | INITIAL REVISION: | | | | | | | | | | DOCUMENT NUMBER SD-75783-001 | | | | | | | |
| 1 PLACE ± 0.25 | | DRWN: KLANG 2005/04/15 | | | | | | | | | | | | | | | | | |
| 0 PLACES ± | | APPR: RNELSON 2005/04/18 | | | | | | | | | | DOC TYPE | | DOC PART | | REVISION | | | |
| DRAFT WHERE APPLICABLE MUST REMAIN WITHIN DIMENSIONS | | THIRD ANGLE PROJECTION | | DRAWING | | SERIES | | MATERIAL NUMBER | | CUSTOMER | | SHEET NUMBER | | | | | | | |
| | |  | | C-SIZE | | 75783 | | SEE TABLE | | GENERAL MARKET | | 11 OF 13 | | | | | | | |

RIGHT ANGLE CONNECTOR WITH RETENTION FIT & THRU-HOLE SHELL PCB FOOT PRINT

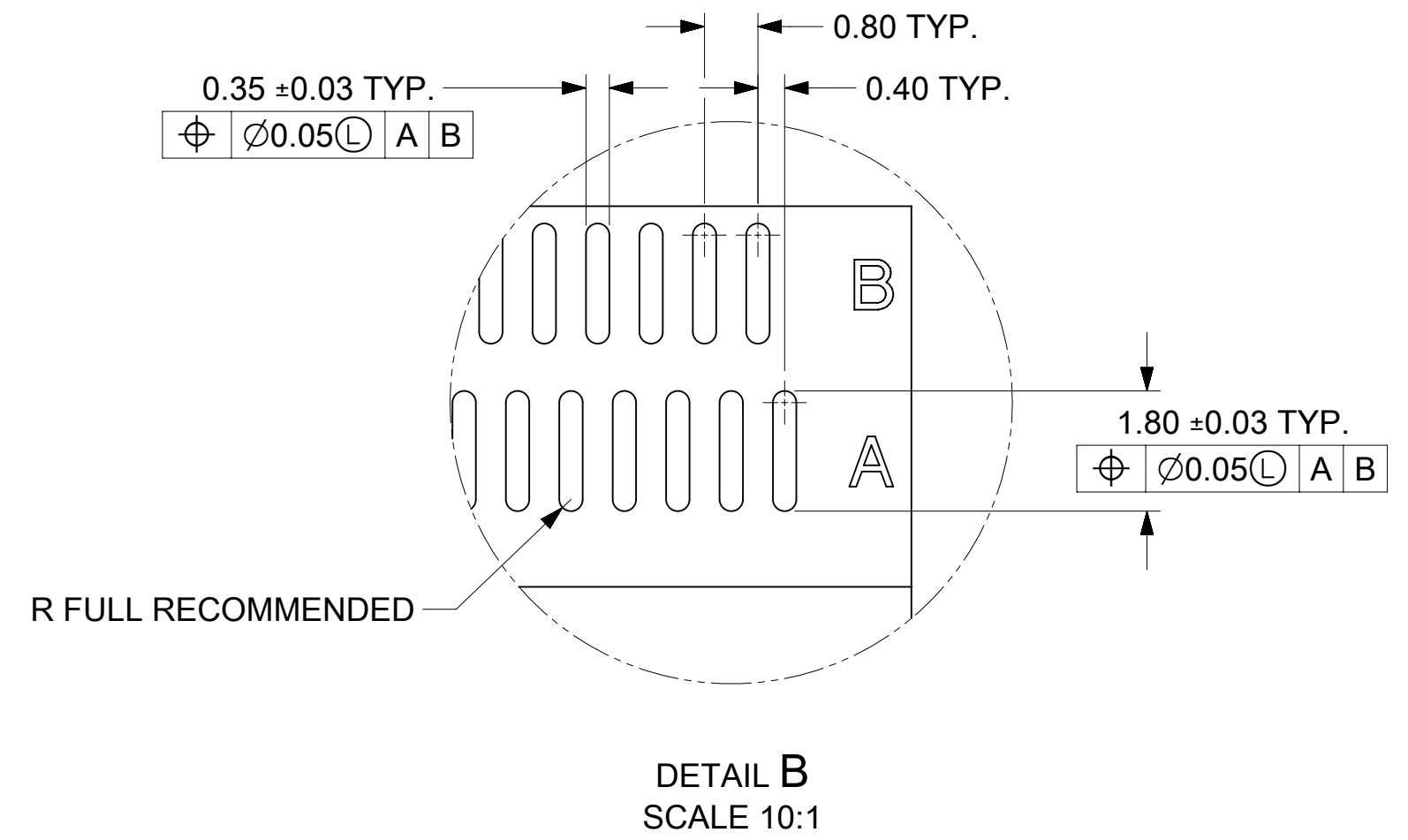
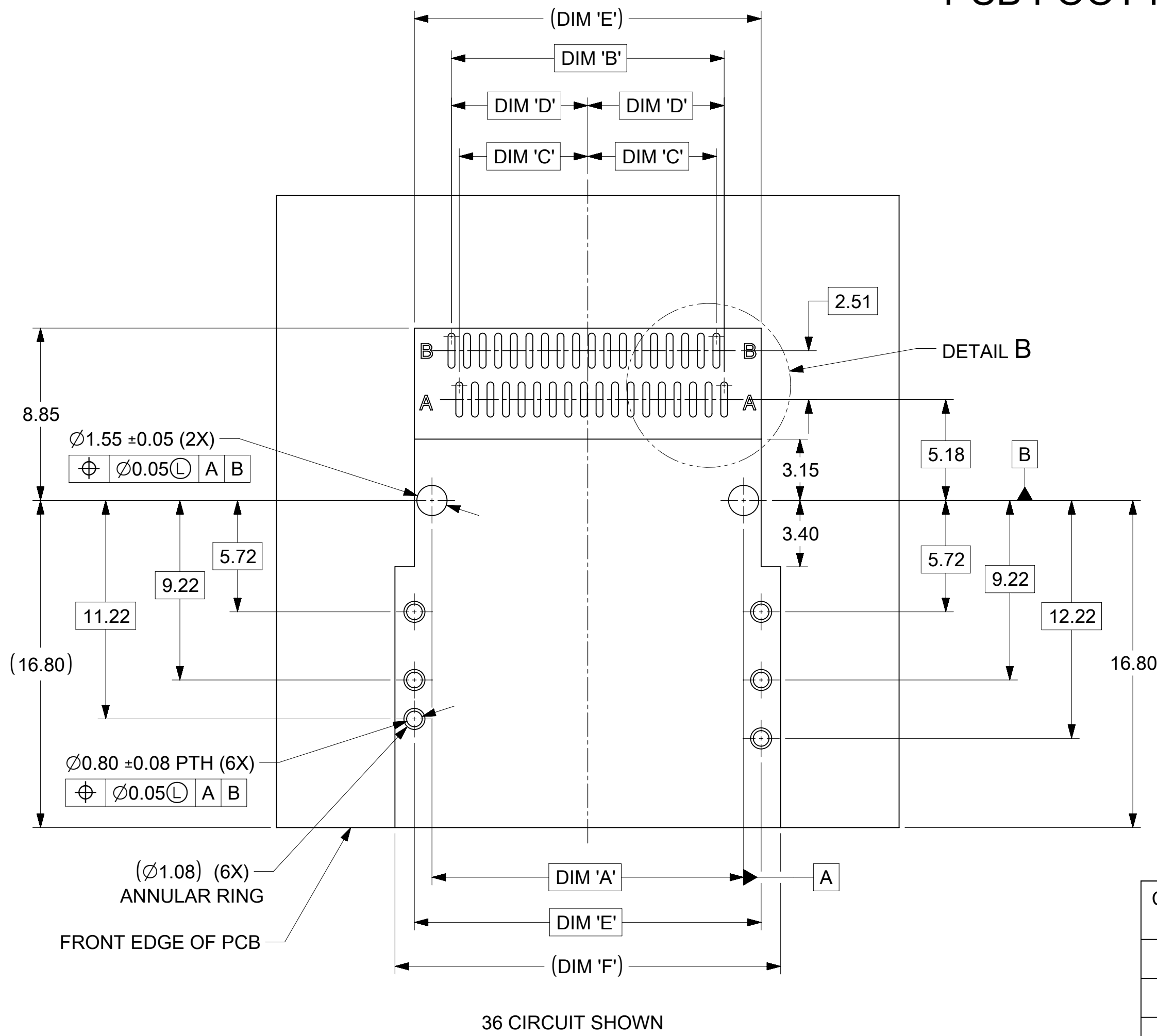









| CIRCUIT SIZE | DIMENSIONS | | | | | |
|--------------|------------|-----------------------|-------------------|-------------------|----------------------------------|-----------------------|
| | PEG TO PEG | FIRST PAD TO LAST PAD | CENTERLINE TO PAD | CENTERLINE TO PAD | CONNECTOR WIDTH SHELL PEG TO PEG | SHELL FOOTPRINT WIDTH |
| | DIM 'A' | DIM 'B' | DIM 'C' | DIM 'D' | DIM 'E' | DIM 'F' |
| 26 | 12.00 | 10.00 | 4.60 | 5.00 | 13.80 | 15.80 |
| 36 | 16.00 | 14.00 | 6.60 | 7.00 | 17.80 | 19.80 |
| 50 | 21.60 | 19.60 | 9.40 | 9.80 | 23.40 | 25.40 |
| 68 | 28.80 | 26.80 | 13.00 | 13.40 | 30.60 | 32.60 |

| | | | | |
|--|--|--|--|--|
| SYMBOLS ▽ = 0 ▽ = 0 ▽ = 0 ▽ = 0 ▽ = 0 ▽ = 0 ▽ = 0 ▽ = 0 ▽ = 0 ▽ = 0 ▽ = 0 ▽ = 0 | DIMENSION UNITS: mm SCALE: 5:1 | CURRENT REV DESC: OBSOLETE PART NO EC NO: 696749 DRWN: MUM 2019/03/27 CHK'D: GB 2019/11/06 APPR: JKACHLIC 2022/02/23 | | |
| | GENERAL TOLERANCES (UNLESS SPECIFIED) ANGULAR TOL ± 0.5° 4 PLACES ± 3 PLACES ± 2 PLACES ± 0.13 1 PLACE ± 0.25 0 PLACES ± | | | I-PASS R/A CONNECTOR INTERNAL ASSY W/SHELL 0.8MM PITCH I/O |
| | INITIAL REVISION: DRWN: KLANG 2005/04/15 APPR: RNELSON 2005/04/18 | | | PRODUCT CUSTOMER DRAWING |
| | DRAFT WHERE APPLICABLE MUST REMAIN WITHIN DIMENSIONS THIRD ANGLE PROJECTION DRAWING SERIES: C-SIZE 75783 | | | DOCUMENT NUMBER: SD-75783-001 DOC TYPE: PSD DOC PART: 001 REVISION: F1 |
| MATERIAL NUMBER: SEE TABLE CUSTOMER: GENERAL MARKET | | SHEET NUMBER: 12 OF 13 | | |

H
G
F
E
D
C
B
A

| DATE | REV | DESCRIPTION |
|------------|-----|---|
| 2018/03/20 | F | 1. REMASTERED FROM MODEL MANAGER 2. SHEET 1, NOTE 3, COPLANAR DISTANCE CHANGED FROM 0.15 TO 0.10 |
| 2019/03/28 | F1 | 1. RECREATED IN NX 2. OBSOLETED PART NO 757830052,757830145,757830146,757830326 |
| | | |
| | | |
| | | |

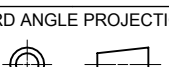
| | | | | | | |
|---|---|---------|-------------------------------------|-----------------|----------------|--------------|
| SYMBOLS  = 0  = 0  = 0  = 0  = 0  = 0  = 0  = 0  = 0 | THIS DRAWING CONTAINS INFORMATION THAT IS PROPRIETARY TO MOLEX ELECTRONIC TECHNOLOGIES, LLC AND SHOULD NOT BE USED WITHOUT WRITTEN PERMISSION | | | | | |
| | DIMENSION UNITS | SCALE | CURRENT REV DESC: OBSOLETED PART NO | | | |
| | mm | 1:1 | | | | |
| | GENERAL TOLERANCES (UNLESS SPECIFIED) | | EC NO: 696749 | | | |
| | ANGULAR TOL ± 0.5° | | DRWN: MUM | 2019/03/27 | | |
| | 4 PLACES ± | | CHK'D: GB | 2019/11/06 | | |
| | 3 PLACES ± | | APPR: JKACHLIC | 2022/02/23 | | |
| | 2 PLACES ± 0.13 | | INITIAL REVISION: | | | |
| | 1 PLACE ± 0.25 | | DRWN: KLANG | 2005/04/15 | | |
| | 0 PLACES ± | | APPR: RNELSON | 2005/04/18 | | |
| DRAFT WHERE APPLICABLE MUST REMAIN WITHIN DIMENSIONS | THIRD ANGLE PROJECTION | DRAWING | SERIES | MATERIAL NUMBER | CUSTOMER | SHEET NUMBER |
| |  | C-SIZE | 75783 | SEE TABLE | GENERAL MARKET | 13 OF 13 |



I-PASS R/A CONNECTOR
INTERNAL ASSY W/SHELL 0.8MM PITCH I/O

PRODUCT CUSTOMER DRAWING

| | | | |
|-----------------|----------|----------|----------|
| DOCUMENT NUMBER | DOC TYPE | DOC PART | REVISION |
| SD-75783-001 | PSD | 001 | F1 |