



**SPECIFICATION SHEET**

<b>SPECIFICATION SHEET NO.</b>	P0610- SOT23BC847AS1E
<b>DATE</b>	June 10, 2022
<b>REVISION</b>	A0
<b>DESCRIPTION</b>	SMD Plastic-Encapsulate Transistors, SOT-23 series, 3 pads BC847A Type, NPN, Collector-Emitter Voltage 45V. Collector Current 100mA Max. Operating Temp. Range -65°C ~+150°C, Package in Tape/Reel, 3000pcs/Reel RoHS/RoHS III compliant
<b>CUSTOMER</b>	
<b>CUSTOMER PART NUMBER</b>	
<b>CROSS REF. PART NUMBER</b>	
<b>ORIGINAL PART NUMBER</b>	MDD BC847A
<b>PART CODE</b>	SOT23BC847AS1E

<b>VENDOR APPROVE</b>			
Issued/Checked/Approved			
DATE: June 10, 2022			

<b>CUSTOMER APPROVE</b>	
DATE:	

6/13/2022

**SMD PLASTIC-ENCAPULATE TRANSISTORS SOT23 SERIES**

**MAIN FEATURE**

- Ideally suited for automatic insertion



**APPLICATION**

- For Switching and AF Amplifier Applications

**RFQ**

[Request For Quotation](#)

**PART CODE GUIDE**

SOT23	BC847A	S	1E
1	2	3	4

1) **SOT23**: SMD Plastic-Encapsulate Transistors, 3 pads SOT-23 series Code

2) **BC847A**: Type code for BC847A Type

3) **S**: Package code, Package in Tape/Reel, 3000pcs/Reel

4) **1E**: Marking code for "1E" on the case surface, Different Marking for different specification

**MORE ITEMS LIST**

SOT23BC846AS1A	SOT23BC846BS1B	
<b>SOT23BC847AS1E</b>	SOT23BC847BS1F	SOT23BC847CS1G
SOT23BC848AS1J	SOT23BC848BS1K	SOT23BC848CS1L

**SMD PLASTIC-ENCAPULATE TRANSISTORS SOT23 SERIES**

**DIMENSION (Unit: Inch/mm)**

Image for reference

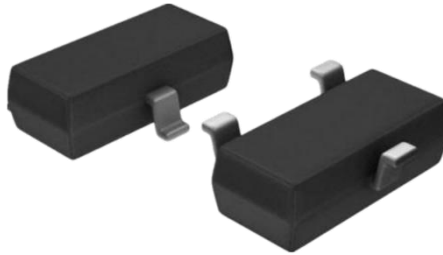

Marking: 1E

SOT-23

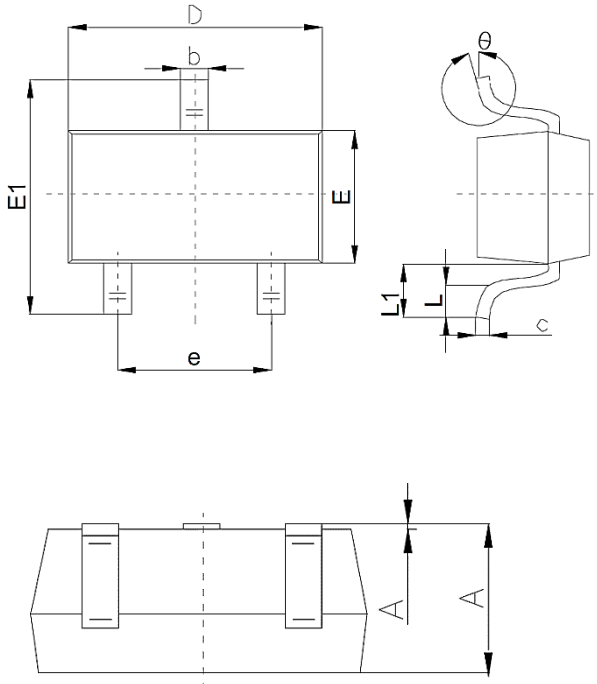

Symbol	Value ( mm )		
	Min.	Typ.	Max.
A	1.00		1.40
A1			0.10
b	0.35		0.50
c	0.10		0.20
D	2.70	2.90	3.10
E	1.40		1.60
E1	2.40		2.80
e		1.90	
L	0.10		0.30
L1	0.40		
θ	0°		10°

Recommend Pad Layout

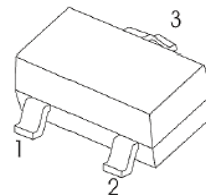
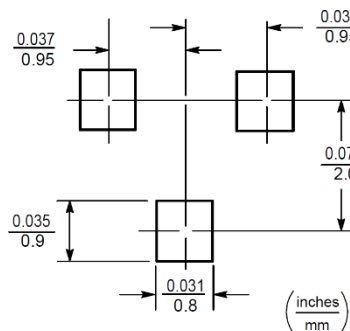

- 1.Base
- 2.Emmitter
- 3.Collector

**SMD PLASTIC-ENCAPULATE TRANSISTORS SOT23 SERIES**
**MECHANICAL DATA**

Case	Terminals	Polarity	Mounting Position	Weight per piece
JEDEC SOT-23 molded plastic body	Solder plated, Solderable per MIL-STD-750, Method 2026	Polarity symbol marking on case	Any	0.00019 Ounce, 0.00591 grams

**MAX. RATINGS AT Ta=25 °C**

Parameter	SYMBOLS	VALUE	UNITS
		LIMIT	
Collector-base Voltage	V <sub>CBO</sub>	50	Volts
Collector-emitter Voltage	V <sub>CEO</sub>	45	Volts
Emitter-base Voltage	V <sub>EBO</sub>	6	Volts
Collector Current - Continuous	I <sub>C</sub>	0.10	A
Collector Power Dissipation	P <sub>C</sub>	200	mW
Junction Temperature	T <sub>J</sub>	+150	°C
Storage Temperature Range	T <sub>STG</sub>	-65 ~ +150	°C

**SMD PLASTIC-ENCAPULATE TRANSISTORS SOT23 SERIES**
**ELECTRICAL CHARACTERISTICS AT Ta= 25 °C**

Parameter	SYMBOLS	VALUE			UNIT	Condition
		Min.	Typ.	Max.		
<b>Collector-base Breakdown Voltage</b>	V <sub>CBO</sub>	50			V	I <sub>c</sub> = 10 μA, I <sub>E</sub> =0
<b>Collector-emitter Breakdown Voltage</b>	V <sub>CEO</sub>	45			V	I <sub>c</sub> = 10mA, I <sub>B</sub> =0
<b>Emitter-base Breakdown Voltage</b>	V <sub>EBO</sub>	6			V	I <sub>E</sub> = 10 μA, I <sub>C</sub> =0
<b>Collector Cut-off Current</b>	I <sub>CBO</sub>			0.1	μA	V <sub>CB</sub> =50V, I <sub>E</sub> =0
<b>Collector Cut-off Current</b>	I <sub>CEO</sub>			0.1	μA	V <sub>CB</sub> =45V, I <sub>B</sub> =0
<b>Emitter Cut-off Current</b>	I <sub>EBO</sub>			0.1	μA	V <sub>EB</sub> = 5V, I <sub>C</sub> =0
<b>DC Current Gain</b>	h <sub>FE</sub>	110		220		V <sub>CE</sub> =5V, I <sub>C</sub> =2 mA
<b>Collector-emitter Saturation Voltage</b>	V <sub>CE(sat)</sub>			0.5	V	I <sub>C</sub> =100mA, I <sub>B</sub> =5 mA
<b>Base-emitter Saturation Voltage</b>	V <sub>BE(sat)</sub>			1.1	V	I <sub>C</sub> =100mA, I <sub>B</sub> =5 mA
<b>Transition Frequency</b>	f <sub>T</sub>		100		MHz	V <sub>CE</sub> =5 V, I <sub>C</sub> =10mA f= 100 MHz
<b>Collector Output Capacitance</b>	C <sub>ob</sub>			4.5	pF	V <sub>CB</sub> =10 V, f=1 MHz

**SMD PLASTIC-ENCAPULATE TRANSISTORS SOT23 SERIES**
**RELIABILITY**

Number	Experiment Items	Experiment Method And Conditions	Reference Documents
1	Solder Resistance Test	Test 260°C± 5°C for 10 ± 2 sec. Immerse body into solder 1/16" ± 1/32"	MIL-STD-750D METHOD-2031.2
2	Solderability Test	230°C ±5°C for 5 sec.	MIL-STD-750D METHOD-2026.1 0
3	Pull Test	1 kg in axial lead direction for 10 sec.	MIL-STD-750D METHOD-2036.4
4	Bend Test	0.5Kg Weight Applied To Each Lead, Bending Arcs 90 °C ± 5 °C For 3 Times	MIL-STD-750D METHOD-2036.4
5	High Temperature Reverse Bias Test	TA=100°C for 1000 Hours at VR=80% Rated VR	MIL-STD-750D METHOD-1038.4
6	Forward Operation Life Test	TA=25°C Rated Average Rectified Current	MIL-STD-750D METHOD-1027.3
7	Intermittent Operation Life Test	On state: 5 min with rated IRMS Power Off state: 5 min with Cool Forced Air. On and off for 1000 cycles.	MIL-STD-750D METHOD-1036.3
8	Pressure Cooker Test	15 PSIG, TA=121°C, 4 hours	MIL-S-19500 APPENOIXC
9	Temperature Cycling Test	-55°C~+125°C; 30 Minutes For Dwelled Time 5 minutes for transferred time. Total: 10 cycles.	MIL-STD-750D METHOD-1051.7
10	Thermal Shock Test	0°C for 5 minutes., 100°C for 5minutes, Total: 10 cycles	MIL-STD-750D METHOD-1056.7
11	Forward Surge Test	8.3ms Single Sale Sine-wave One Surge.	MIL-STD-750D METHOD-4066.4
12	Humidity Test	TA=65°C, RH=98% for 1000 hours.	MIL-STD-750D METHOD-1021.3
13	High Temperature Storage life Test	150°C for 1000 Hours	MIL-STD-750D METHOD-1031.5

**SMD PLASTIC-ENCAPULATE TRANSISTORS SOT23 SERIES**

**SUGGESTED REFLOW PROFILE (For Reference Only)**

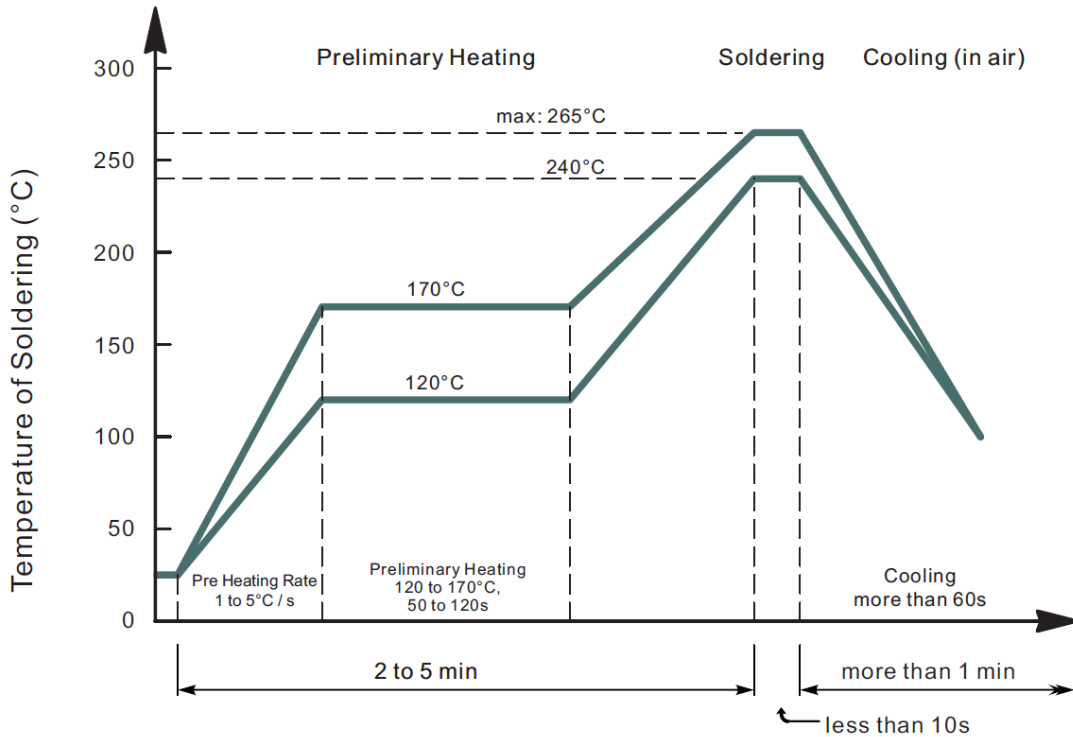

- Recommended peak temperature is over 245°C, If peak temperature is below 245 °C, you may adjust the following parameters; time length of peak temperature (longer), time length of soldering (longer), thickness of solder paste (thicker)
- Welding shall not exceed 2 times
- Remark: lead free solder paste (96.5 sn/3.0 Ag/0.5Cu)

**SMD PLASTIC-ENCAPULATE TRANSISTORS SOT23 SERIES**

**RATINGS AND CHARACTERISTIC CURVES (For Reference Only)**

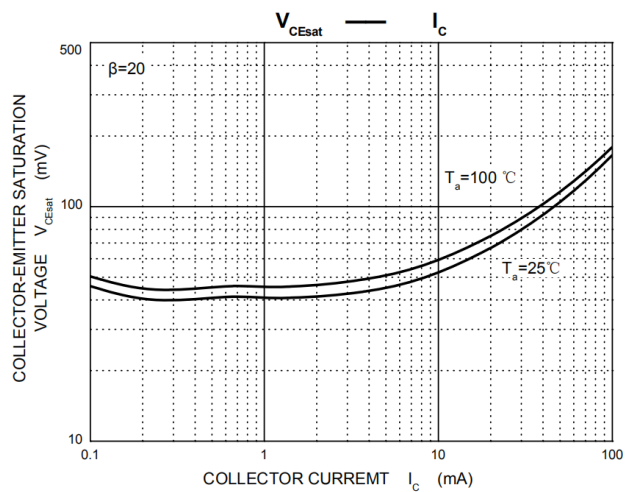
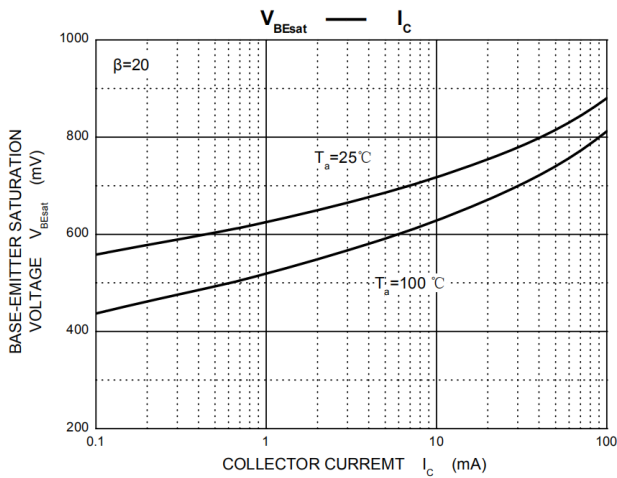
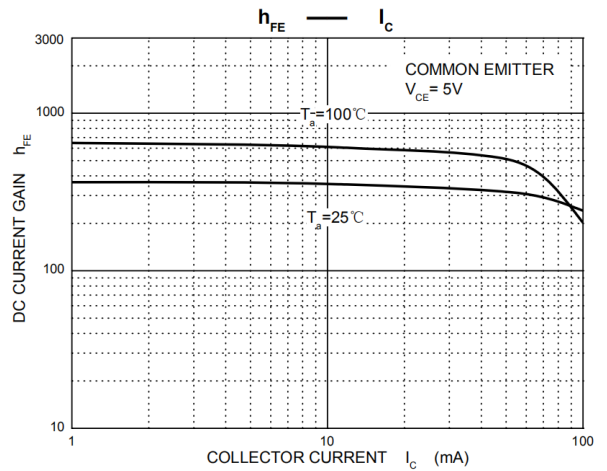
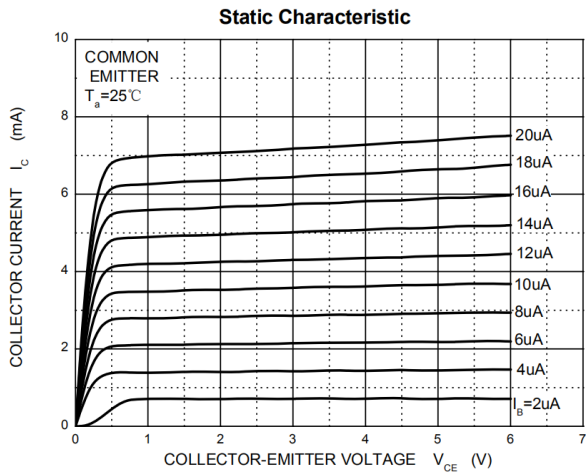



**SMD PLASTIC-ENCAPULATE TRANSISTORS SOT23 SERIES**

**RATINGS AND CHARACTERISTIC CURVES (For Reference Only)**

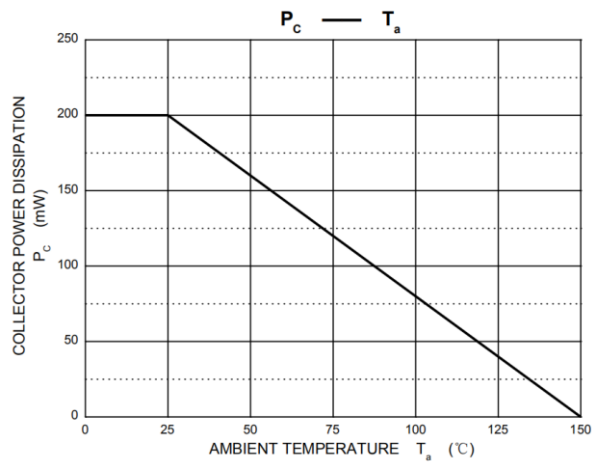
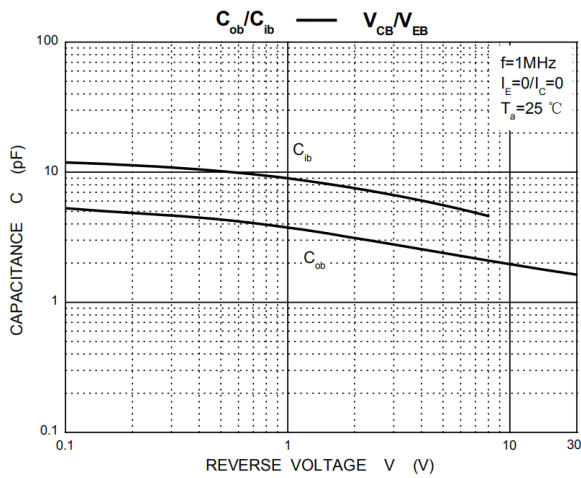
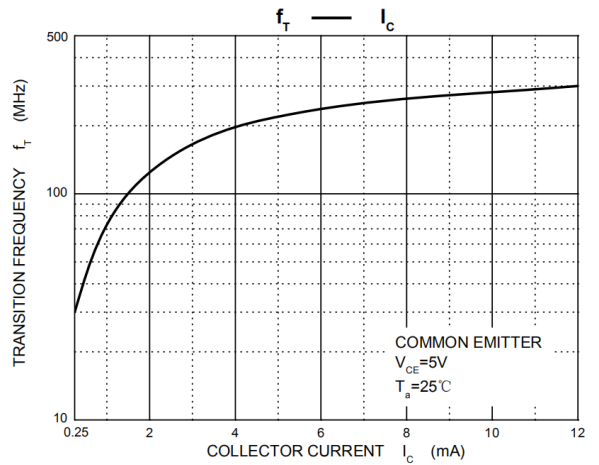
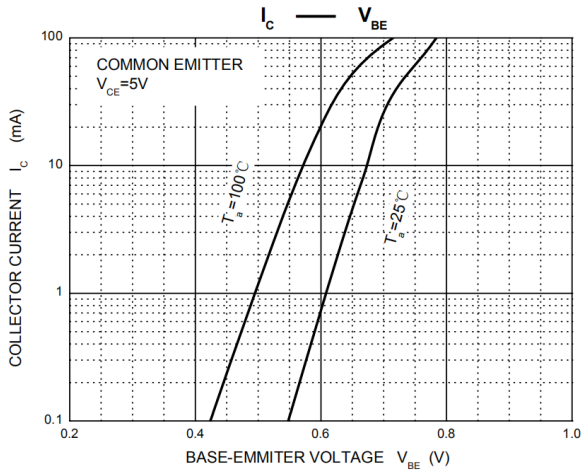

**SMD PLASTIC-ENCAPULATE TRANSISTORS SOT23 SERIES**
**TAPE/REEL (Unit: mm)**

All Devices are packed in accordance with EIA standard RS-481-A and specifications.

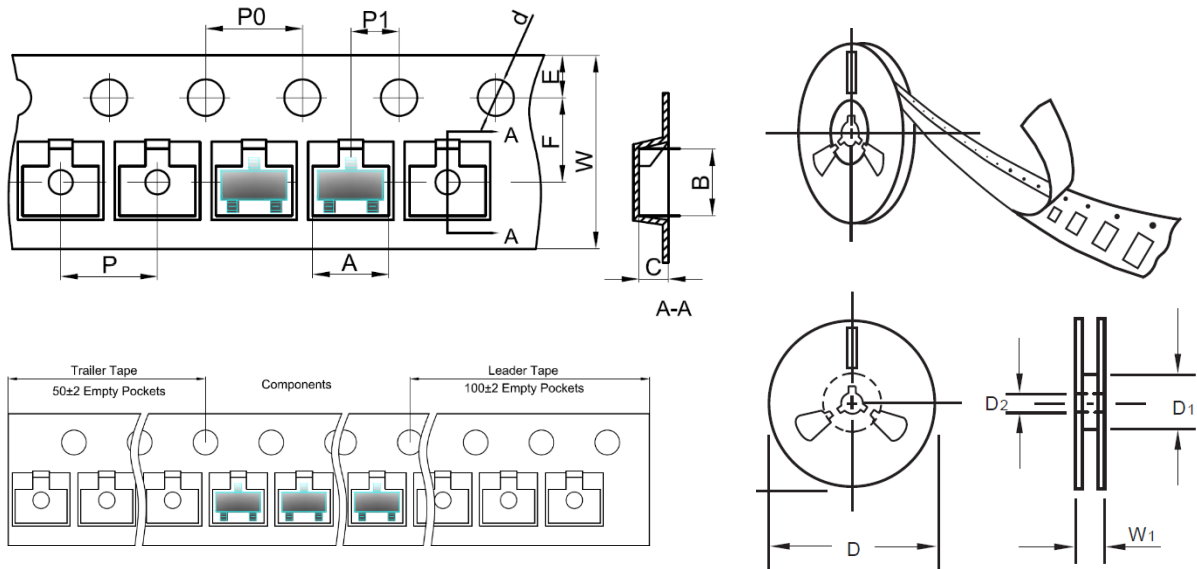

Item	Symbol	Tolerance	SOT-23
Carrier width	A	0.1	3.15
Carrier Length	B	0.1	2.77
Carrier Depth	C	0.1	1.22
Sprocket hole	d	0.05	1.55
7"Reel outside diameter	D	2.0	178.00
7"Reel inner diameter	D1	Min.	54.4
Feed hole diameter	D2	0.5	13.00
Sprocket hole position	E	0.1	1.75
Punch hole position	F	0.1	3.50
Punch hole pitch	P	0.1	4.00
Sprocket hole pitch	P0	0.1	4.00
Embossment center	P1	0.1	2.00
Overall tape thickness	T	0.1	0.25
Tape width	W	0.3	8.00
Reel width	W1	1.0	19.50

**SMD PLASTIC-ENCAPULATE TRANSISTORS SOT23 SERIES**

**PACKAGE**

Case Code	SOT-23
Reel Size	7"
Reel Size	178 mm
MPQ/Reel	3000 pcs
Qty. /Box	6000 pcs
G.W/Box	1 LBS

**DISCLAIMER**

NextGen Component, Inc. reserves the right to make changes to the product(s) and or information contained herein without notice. No liability is assumed as a result of their use or application. No rights under any patent accompany the sale of any such product(s) or information