NI-9770

Specifications

2022-10-07

Contents

NI 9770 Datasheet..... 3

NI 9770 Datasheet





- 1-channel, 320 kS/s
- Support for RF emissions measurements from 30 kHz to 100 MHz
- Software-selectable bandwidth from 3.2 kHz to 256 kHz
- 104 dB dynamic range
- Provides hardware detection of total power in the frequency range and time domain analysis
- -40°C to 70°C operating temperature range, 5 g vibration, 50 g shock
- SMA connectors

The NI-9770 is a single-channel C Series module designed to bring more advanced sensor measurements to CompactRIO systems used within machine condition

monitoring. The NI-9770 measures RF emissions in the frequency range of 30 kHz to 100 MHz using a narrow configurable bandwidth to help detect electrical anomalies, which can be a leading indicator of machine failure. The SMA connectors on the NI-9770 provide antenna connectivity and allow the CompactRIO system to be installed for maximum uptime. Subject matter experts can monitor signals over time using the swept frequency representation to perform Electromagnetic Signature Analysis (EMSA). The NI-9770 detects the following electrical phenomena:

- Partial discharge
- Corona discharge
- Arcing
- Any other phenomena that result in RF emissions

 <p>Kit Contents</p>	<ul style="list-style-type: none"> • NI 9770 • NI 9770 Getting Started Guide
 <p>Recommended Accessories</p>	<ul style="list-style-type: none"> • 781611-01 Precision Coaxial Cable, 1.0 m, K-Type, Male-Male • 780487-01 Torque Screwdriver, Preset (100 NCM)

NI C Series Overview



NI provides more than 100 C Series modules for measurement, control, and communication applications. C Series modules can connect to any sensor or bus and allow for high-accuracy measurements that meet the demands of advanced data acquisition and control applications.

- Measurement-specific signal conditioning that connects to an array of sensors and signals
- Isolation options such as bank-to-bank, channel-to-channel, and channel-to-earth ground
- -40 °C to 70 °C temperature range to meet a variety of application and environmental needs
- Hot-swappable

The majority of C Series modules are supported in both CompactRIO and CompactDAQ platforms and you can move modules from one platform to the other with no modification.

CompactRIO



CompactRIO combines an open-embedded architecture with small size, extreme ruggedness, and C Series modules in a platform powered by the NI LabVIEW reconfigurable I/O (RIO) architecture. Each system contains an FPGA for custom timing, triggering, and processing with a wide array of available modular I/O to meet any embedded application requirement.

Software

LabVIEW Professional Development System for Windows

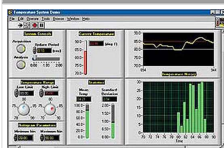

- Use advanced software tools for large project development
- Use advanced measurement analysis and digital signal processing
- Take advantage of open connectivity with DLLs, ActiveX, and .NET objects
- Build DLLs, executables, and MSI installers

NI LabVIEW FPGA Module

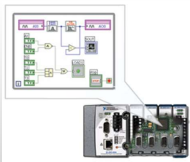

- Design FPGA applications for NI RIO hardware
- Program with the same graphical environment used for desktop and real-time applications
- Execute control algorithms with loop rates up to 300 MHz
- Implement custom timing and triggering logic, digital protocols, and DSP algorithms
- Incorporate existing HDL code and third-party IP including Xilinx IP generator functions
- Purchase as part of the LabVIEW Embedded Control and Monitoring Suite

NI LabVIEW Real-Time Module

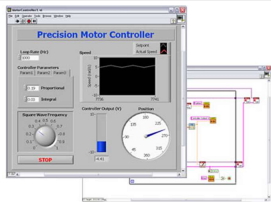

- Design deterministic real-time applications with LabVIEW graphical programming
- Download to dedicated NI or third-party hardware for reliable execution and a wide selection of I/O
- Take advantage of built-in PID control, signal processing, and analysis functions
- Automatically take advantage of multicore CPUs or set processor affinity manually
- Take advantage of real-time OS, development and debugging support, and board support
- Purchase individually or as part of a LabVIEW suite

Circuitry

The RF IN signal of the NI-9770 is filtered, mixed, and then sampled by a 16-bit IF digitizer. The LO IN and LO OUT connectors provide local oscillator signal sharing between modules to enable phase coherency.

Figure 1. NI-9770 Input Circuitry

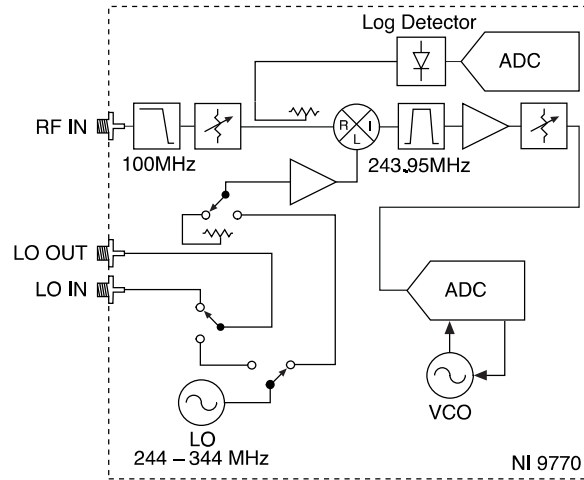

NI-9770 Specifications

The following specifications are typical for the range -40 °C to 70 °C unless otherwise noted.

Caution Do not operate the NI-9770 in a manner not specified in this document. Product misuse can result in a hazard. You can compromise the safety protection built into the product if the product is damaged in any way. If the product is damaged, return it to NI for repair.

Input Characteristics

Number of channels	1 RF input
Local oscillator	1 LO input
ADC Resolution	
IF digitizer	16 bits

Log detector		16 bits
Type of ADC		
IF digitizer	Delta-Sigma	
Log detector	Successive Approximation Register (SAR)	
Sample rate		
IF digitizer		320 kS/s
Log detector		190.512 kS/s
Input power		
Maximum RF IN power		+10 dBm
Maximum LO IN power		+15 dBm
Absolute Maximum Input		
RF IN		+10 dBm
LO IN		+15 dBm
Input impedance		
RF IN	50 Ω (nominal)	
LO IN	50 Ω (nominal)	
Amplitude accuracy ^[1] at 30 kHz to 100 MHz		± 4.0 dB

Input coupling	AC
Average noise floor at 1 MHz to 100 MHz ^[2]	-155 dBm/Hz
Instantaneous bandwidth	3.2 kHz to 256 kHz
Phase noise at 10 MHz center frequency	
10 kHz offset	< -88 dBc/Hz (nominal)
100 kHz offset	< -104 dBc/Hz (nominal)
Third-order intermodulation at maximum gain	2 dBm
Gain compression	-2 dBm (nominal)
Dynamic range ^[3]	104 dB (nominal)
Residual spurs^[4]	
> 0.5 MHz to 2 MHz	-100 dBm
> 2 MHz to 100 MHz	-105 dBm
IF frequency	243.9168 MHz with a bandwidth of 256 kHz
Specification	1 MHz to 100 MHz
Image rejection	-64 dBc
IF rejection	-64 dBc
IF/2 rejection	-64 dBc

Table 1. Image and IF Rejection

Output Characteristics

Number of channels	1 LO output
Output coupling	AC
Frequency range ^[5]	244 MHz to 344 MHz
Output impedance	50 Ω (nominal)
Maximum LO OUT power ^[6]	+15 dBm
Sample rate	320 kHz

Power Requirements

Power consumption from chassis	
Thermal Dissipation	1 W maximum
Sleep mode	25 μ W maximum

Physical Characteristics

Weight	159 g (5.6 oz)
--------	----------------

Absolute Maximum Input

RF IN	+10 dBm
-------	---------

LO IN	+15 dBm
-------	---------

Hazardous Locations

U.S. (UL)	Class I, Division 2, Groups A, B, C, D, T4; Class I, Zone 2, AEx nA IIC T4 Gc
Canada (C-UL)	Class I, Division 2, Groups A, B, C, D, T4; Ex nA IIC T4 Gc
Europe (ATEX) and International (IECEX)	Ex nA IIC T4 Gc DEMKO 12 ATEX 1202658X IECEX UL 14.0089X

Safety Compliance and Hazardous Locations Standards

This product is designed to meet the requirements of the following electrical equipment safety standards for measurement, control, and laboratory use:

- IEC 61010-1, EN 61010-1
- UL 61010-1, CSA C22.2 No. 61010-1
- EN 60079-0, EN 60079-7
- IEC 60079-0, IEC 60079-7
- UL 60079-0, UL 60079-7
- CSA C22.2 No. 60079-0, CSA C22.2 No. 60079-7

Note For safety certifications, refer to the product label or the [Product Certifications and Declarations](#) section.

Electromagnetic Compatibility

CE Compliance

- 2014/34/EU; Potentially Explosive Atmospheres (ATEX)

Product Certifications and Declarations

Refer to the product Declaration of Conformity (DoC) for additional regulatory compliance information. To obtain product certifications and the DoC for NI products, visit ni.com/product-certifications, search by model number, and click the appropriate link.

Shock and Vibration

To meet these specifications, you must panel mount the system.

Operating vibration	
Random	5 g RMS, 10 Hz to 500 Hz
Sinusoidal	5 g, 10 Hz to 500 Hz
Operating shock	30 g, 11 ms half sine; 50 g, 3 ms half sine; 18 shocks at 6 orientations

Environmental

Refer to the manual for the chassis you are using for more information about meeting these specifications.

Operating temperature (IEC 60068-2-1, IEC 60068-2-2)	-40 °C to 70 °C
Storage temperature (IEC 60068-2-1, IEC 60068-2-2)	-40 °C to 85 °C

Ingress protection	IP40
Operating humidity (IEC 60068-2-30)	10% RH to 90% RH, noncondensing
Storage humidity (IEC 60068-2-30)	5% RH to 95% RH, noncondensing
Pollution Degree	2
Maximum altitude	5,000 m

Indoor use only.

Environmental Management

NI is committed to designing and manufacturing products in an environmentally responsible manner. NI recognizes that eliminating certain hazardous substances from our products is beneficial to the environment and to NI customers.

For additional environmental information, refer to the **Engineering a Healthy Planet** web page at ni.com/environment. This page contains the environmental regulations and directives with which NI complies, as well as other environmental information not included in this document.

EU and UK Customers

-  **Waste Electrical and Electronic Equipment (WEEE)**—At the end of the product life cycle, all NI products must be disposed of according to local laws and regulations. For more information about how to recycle NI products in your region, visit ni.com/environment/weee.

电子信息产品污染控制管理办法（中国 RoHS）

-  中国 RoHS— NI 符合中国电子信息产品中限制使用某些有害物质指令(RoHS)。关于 NI 中国 RoHS 合规性信息，请登录 ni.com/environment/rohs_china。(For information about China RoHS compliance, go to ni.com/environment/rohs_china.)

¹ Amplitude accuracy is based on -10 dBm to -50 dBm reference level. The value is measured at the center frequency.

² Average noise floor is measured at maximum gain state. Extreme temperatures can affect average noise floor since the amplitude accuracy changes based on ambient temperature.

³ Dynamic range is defined as $2/3 * (\text{third order intermodulation} - \text{average noise floor})$.

⁴ For frequencies < 0.5 MHz, the Local Oscillator signal feeds through to the first mixer and affects residual spurs.

⁵ The frequency output is dependant on the value of the Center Frequency (Hz) control in the Configure RF block when the internal LO is used, and the frequency input to the LO In port when the External LO is used.

⁶ The internal LO has sufficient power to drive two additional slave modules.