



SPECIFICATION
FOR ELECTRO-MAGNET TRANSDUCER

TOTAL PAGE	07	http://www.bestargroups.com	RoHS
------------	----	---	------

Customer		Model Name	BMT2512H12-04 LF
Customer P/N		Product No.	010120
Date	25 Sep. 2015	Issue No.	BS/TET01.584C
Page	01 of 07	Issue Date	2015/09/25

Approval:

- 1.Characteristics
- 2.Dimension
- 3.Reliability Test
- 4.Packing
- 5.Notice
- 6.History change record

Drawn by	Checked by	Approved by	Customer approved
常 琦	陶 红 仲	张 秀 琴	

BeStar Holding Co., Ltd.

No.199 HuangHe West Road,New district,ChangZhou,JiangSu Province,P.R.China

Tel: +86 519 88222567 **Fax:** +86 519 88222551

E-mail: wu@be-star.com <http://www.bestargroups.com>

BMT2512H12-04 LF

1.Characteristics

1.1Technical terms



No.	Item	Specifications
1	Operating Voltage	8...14Vo-p
2	Rated Voltage	12Vo-p
3	a)Rated Current	Max. 55mA
4	a)Sound Output at 10cm	≥85dB
5	Coil Resistance	120± 15 Ω
6	Operating Temperature	-40...+85°C
7	Storage Temperature	-40...+85°C
8	Weight	10g
9	Material	Noryl SE1-GFN2J
a) Value applying rated voltage (1000Hz, 50%duty,square wave)		

1.2 Test method:

1.2.1.Recommended Circuit

the following are examples of externally driven circuits.

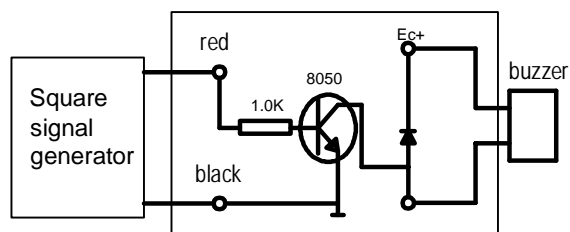

1.2.2.Standard test Fixture

No reaction in space with in 400mm in all direction

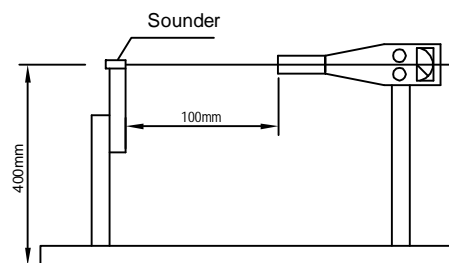

C	2015/09/25	常琦	change the frequency	Date:	2015/09/25	BMT2512H12-04 LF	
B	09/06/03	魏奉玲	RohS	Drawn by:	常琦		
A	01/06/20	胡海青		Checked by:	陶红仲	Transducer	
Rev.	Date	Drawn	Note	Approved by:	张秀琴		
BeStar Holding Co., Ltd.						DRG NO: BS/TET01.584C	Page:2 of 7
www.bestargroups.com wu@be-star.com							

BMT2512H12-04 LF

1.3 Frequency response (square wave 12Vo-p 10cm)

MLS-Frequency Response

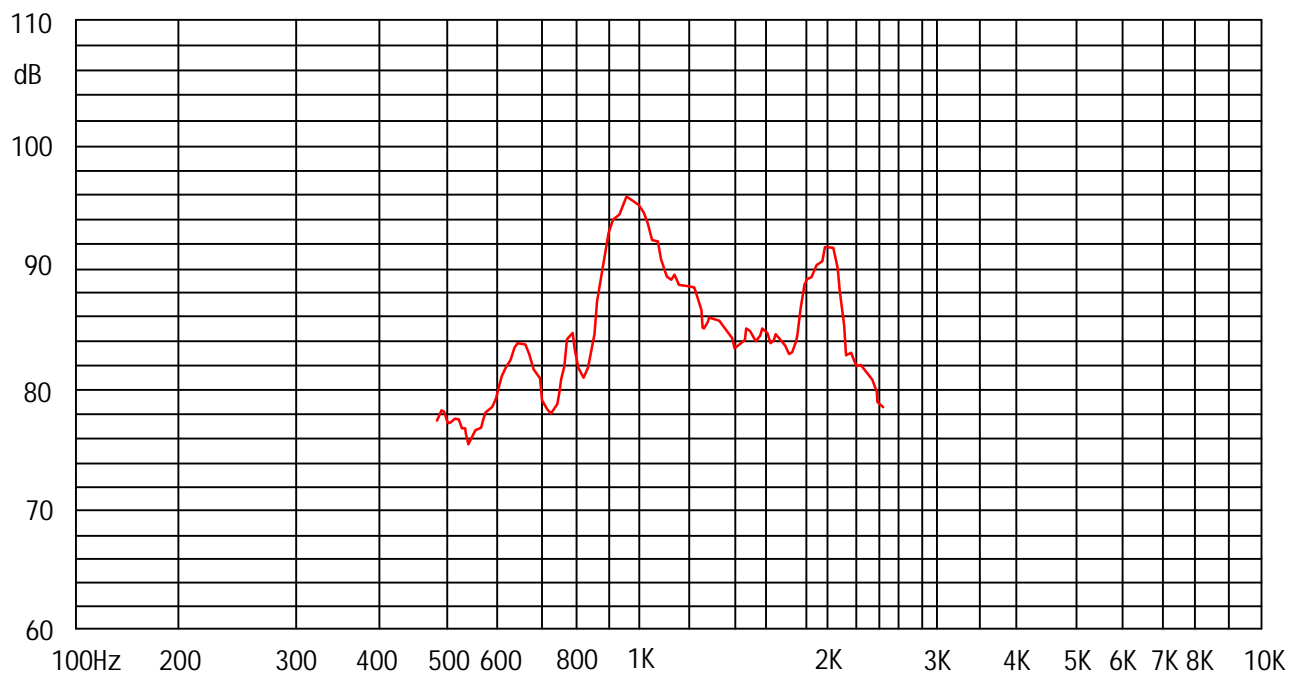

This print and information there in are property to BeStar Holding Co., Ltd. and shall not be used in whole or in part without its written content.

C	2015/09/25	常琦	change the frequency	Date:	2015/09/25	BMT2512H12-04 LF	
B	09/06/03	魏奉玲	RohS	Drawn by:	常琦		
A	01/06/20	胡海青		Checked by:	陶红仲	Transducer	
Rev.	Date	Drawn	Note	Approved by:	张秀琴		
BeStar Holding Co., Ltd.						DRG NO: BS/TET01.584C	Page:3 of 7
www.bestargroups.com wu@be-star.com							

BMT2512H12-04 LF

2. Dimension

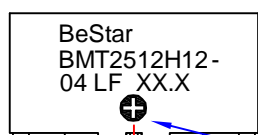
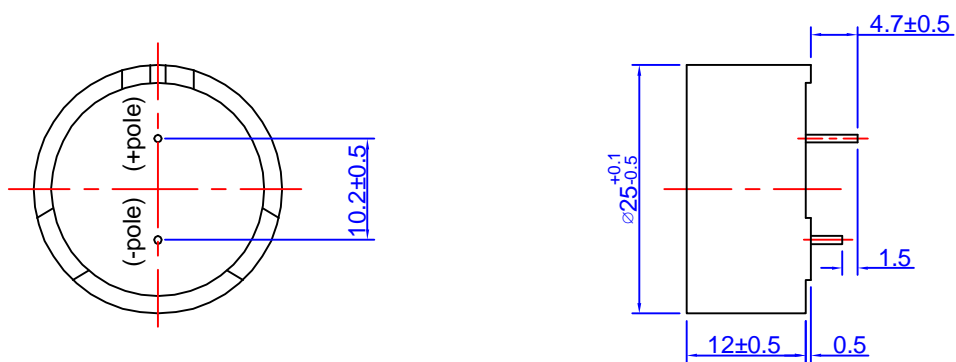

Remark:
 Color of printing:golden
 "XX . X" means "year.month"
 E.g : Jun, 2009 is "09.F"

2- \varnothing 0.8±0.05

Unit:mm Tolerance:±0.3

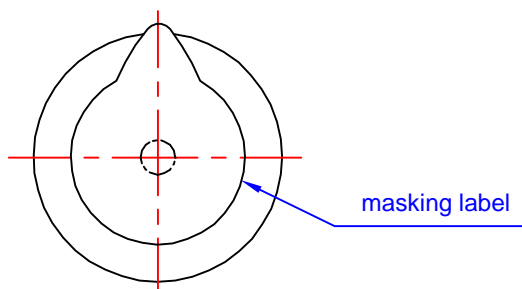

This print and information there in are propriety to BeStar Holding Co., Ltd. and shall not be used in whole or in part without its written content

C	2015/09/25	常琦	change the frequency	Date:	2015/09/25	BMT2512H12-04 LF	
B	09/06/03	魏奉玲	RohS	Drawn by:	常琦		
A	01/06/20	胡海青		Checked by:	陶红仲	Transducer	
Rev.	Date	Drawn	Note	Approved by:	张秀琴		
BeStar Holding Co., Ltd.						DRG NO: BS/TET01.584C	Page:4 of 7
www.bestargroups.com wu@be-star.com							

BMT2512H12-04 LF

3. Reliability test

3.1 high temperature test

Temperature +85°C
Duration 96hrs

3.2 low temperature test

Temperature -40°C
Duration 96hrs

3.3 temperature cycle test

Cycles 5

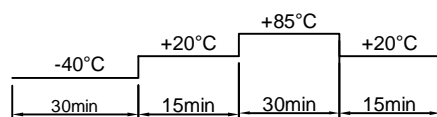

3.4 Humidity cycle test cycles

10

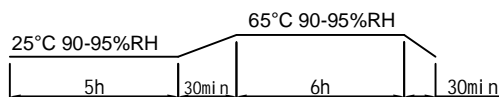

all these tests above should be measured after leaving normal temperature for 2hrs.

3.5 Life test in high temperature

Power supply 12V o-p 1000Hz with duty of 50%
Temperature +85°C
Duration 500hrs

3.6 Life test in low temperature

Power supply 12V o-p 1000Hz with duty of 50%
Temperature -40°C
Duration 500hrs

3.7 Vibration Test

Vibration Frequency 10-55Hz
Amplitude 1.5mm
Direction x,y&z
Duration 2hrs each direction(total 6hrs)

3.8 Drop Test

Height 70cm
(to 10mm thickness woodenboard)
Direction 3

3.9 Solderability test

Solderability temperature 255°C±5
Heat applying time 3sec ±0.5

all these tests above should be measured after leaving normal temperature for 2hrs.

Notice: After the test the part shall meet specifications without any degradation and performance except S.P.L, S.P.L shall be 85dB or more

This print and information there in are proprietary to BeStar Holding Co., Ltd. and shall not be used in whole or in part without its written content.

C	2015/09/25	常琦	change the frequency	Date:	2015/09/25	BMT2512H12-04 LF	
B	09/06/03	魏奉玲	RohS	Drawn by:	常琦		
A	01/06/20	胡海青		Checked by:	陶红仲	Transducer	
Rev.	Date	Drawn	Note	Approved by:	张秀琴		
BeStar Holding Co., Ltd.						DRG NO: BS/TET01.584C	Page:5 of 7
www.bestargroups.com wu@be-star.com							

BMT2512H12-04 LF

4. Packing

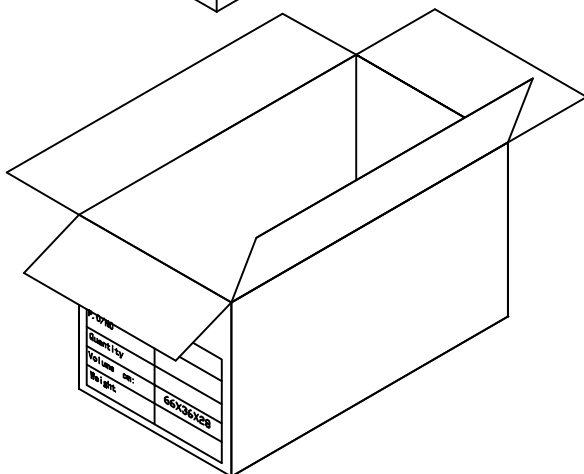
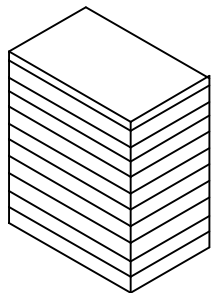

- 1) 50pcs/tray
- 2) 40trays/carton
- 3) 2000 pcs/carton in total
- 4) carton size 66x36x28cm

5. Notice

5.1 The products mustn't be washed

5.2 Storage Condition

The products should be stored in the room, where the temperature/humidity is stable. And avoid such places where there are large temperature changes. Please store the products at the following conditions:

Temperature: -10 to + 40 °C Humidity: 15 to 85% R.H.

5.3 Expire Date on Storage

Expire date (Shelf life) of the products is six months after delivered under the conditions of a sealed and an unopened package. Please use the products within six months after delivered.

If you store the products for a long time (more than six months), use carefully because the products may be degraded in the solderability and/or rusty. Please confirm solderability and characteristics for the products regularly.

5.4 Notice on Product Storage

(1) Please do not store the products in a chemical atmosphere (Acids, Alkali, Bases, Organic gas, Sulfides and so on), because the characteristics may be reduced at quality, and/or be degraded in the solderability due to the storage in a chemical atmosphere.

(2) Please use the products immediately after the package is opened, because the characteristics may be reduced at quality, and/or be degraded in the solderability due to storage under the poor condition.

This print and information there in are proprietary to BeStar Holding Co., Ltd. and shall not be used in whole or in part without its written content.

C	2015/09/25	常琦	change the frequency	Date:	2015/09/25	BMT2512H12-04 LF	
B	09/06/03	魏奉玲	RohS	Drawn by:	常琦		
A	01/06/20	胡海青		Checked by:	陶红仲	Transducer	
Rev.	Date	Drawn	Note	Approved by:	张秀琴		
BeStar Holding Co., Ltd.						DRG NO: BS/TET01.584C	Page:6 of 7
www.bestargroups.com wu@be-star.com							

BMT2512H12-04 LF

6. History change record

version No.	Change Items		Date	Drawn	Approved
	Before	After			
A			01/06/20	胡海青	邵凯
B		RohS	09/06/03	魏奉玲	陶红仲
C	1000~1500Hz	1000Hz	2015/09/25	常琦	张秀琴

This print and information there in are propriety to BeStar Holding Co., Ltd. and shall not be used in whole or in part without its written content.

C	2015/09/25	常琦	change the frequency	Date:	2015/09/25	BMT2512H12-04 LF
B	09/06/03	魏奉玲	RohS	Drawn by:	常琦	
A	01/06/20	胡海青		Checked by:	陶红仲	
Rev.	Date	Drawn	Note	Approved by:	张秀琴	
BeStar Holding Co., Ltd.						www.bestargroups.com wu@be-star.com
						DRG NO: BS/TET01.584C Page:7 of 7