

NTHD5903

Power MOSFET

-20 V, -3.0 A, Dual P-Channel ChipFET™

Features

- Low $R_{DS(on)}$ for Higher Efficiency
- Logic Level Gate Drive
- Miniature ChipFET Surface Mount Package Saves Board Space
- Pb-Free Package is Available

Applications

- Power Management in Portable and Battery-Powered Products; i.e., Cellular and Cordless Telephones and PCMCIA Cards

MAXIMUM RATINGS ($T_A = 25^\circ\text{C}$ unless otherwise noted)

Rating	Symbol	5 secs	Steady State	Unit
Drain-Source Voltage	V_{DS}	-20		V
Gate-Source Voltage	V_{GS}	± 12		V
Continuous Drain Current ($T_J = 150^\circ\text{C}$) (Note 1) $T_A = 25^\circ\text{C}$ $T_A = 85^\circ\text{C}$	I_D	± 3.0 ± 2.2	± 2.2 ± 1.6	A
Pulsed Drain Current	I_{DM}	± 10		A
Continuous Source Current (Diode Conduction) (Note 1)	I_S	-3.0	-2.2	A
Maximum Power Dissipation (Note 1) $T_A = 25^\circ\text{C}$ $T_A = 85^\circ\text{C}$	P_D	2.1 1.1	1.1 0.6	W
Operating Junction and Storage Temperature Range	T_J, T_{stg}	-55 to +150		$^\circ\text{C}$

Maximum ratings are those values beyond which device damage can occur. Maximum ratings applied to the device are individual stress limit values (not normal operating conditions) and are not valid simultaneously. If these limits are exceeded, device functional operation is not implied, damage may occur and reliability may be affected.

1. Surface Mounted on FR4 Board using 1 in sq pad size (Cu area = 1.27 in sq [1 oz] including traces).



ON Semiconductor®

<http://onsemi.com>

$V_{(BR)DSS}$	$R_{DS(on)}$ TYP	I_D MAX
-20 V	130 m Ω @ -4.5 V	-3.0 A
	215 m Ω @ -2.5 V	

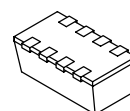
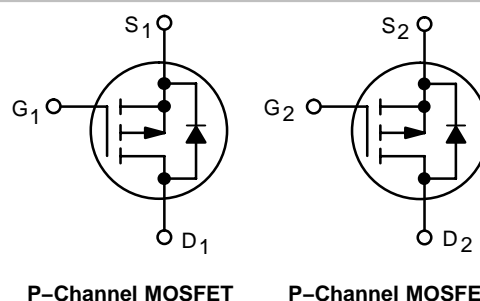

ChipFET
CASE 1206A
STYLE 2

PIN CONNECTIONS

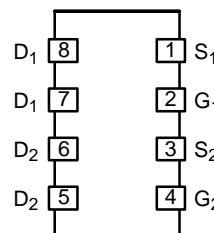

MARKING DIAGRAM

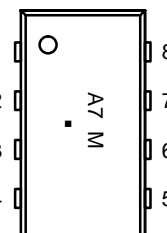

- A7 = Specific Device Code
- M = Month Code
- = Pb-Free Package

ORDERING INFORMATION

Device	Package	Shipping†
NTHD5903T1	ChipFET	3000/Tape & Reel
NTHD5903T1G	ChipFET (Pb-Free)	3000/Tape & Reel

†For information on tape and reel specifications, including part orientation and tape sizes, please refer to our Tape and Reel Packaging Specifications Brochure, BRD8011/D.

NTHD5903

THERMAL CHARACTERISTICS

Characteristic	Symbol	Typ	Max	Unit
Maximum Junction-to-Ambient (Note 2) $t \leq 5$ s Steady State	$R_{\theta JA}$	50 90	60 110	$^{\circ}\text{C/W}$
Maximum Junction-to-Foot (Drain) Steady State	$R_{\theta JF}$	30	40	$^{\circ}\text{C/W}$

2. Surface Mounted on FR4 Board using 1 in sq pad size (Cu area = 1.27 in sq [1 oz] including traces).

ELECTRICAL CHARACTERISTICS ($T_J = 25^{\circ}\text{C}$ unless otherwise noted)

Characteristic	Symbol	Test Condition	Min	Typ	Max	Unit
Static						
Gate Threshold Voltage	$V_{GS(th)}$	$V_{DS} = V_{GS}, I_D = -250 \mu\text{A}$	-0.6			V
Gate-Body Leakage	I_{GSS}	$V_{DS} = 0 \text{ V}, V_{GS} = \pm 12 \text{ V}$			± 100	nA
Zero Gate Voltage Drain Current	I_{DSS}	$V_{DS} = -16 \text{ V}, V_{GS} = 0 \text{ V}$			-1.0	μA
		$V_{DS} = -16 \text{ V}, V_{GS} = 0 \text{ V}, T_J = 85^{\circ}\text{C}$			-5.0	
On-State Drain Current (Note 3)	$I_{D(on)}$	$V_{DS} \leq -5.0 \text{ V}, V_{GS} = -4.5 \text{ V}$	-10			A
Drain-Source On-State Resistance (Note 3)	$r_{DS(on)}$	$V_{GS} = -4.5 \text{ V}, I_D = -2.2 \text{ A}$		0.130	0.155	Ω
		$V_{GS} = -3.6 \text{ V}, I_D = -2.0 \text{ A}$		0.150	0.180	
		$V_{GS} = -2.5 \text{ V}, I_D = -1.7 \text{ A}$		0.215	0.260	
Forward Transconductance (Note 3)	g_{fs}	$V_{DS} = -10 \text{ V}, I_D = -2.2 \text{ A}$		5.0		S
Diode Forward Voltage (Note 3)	V_{SD}	$I_S = -2.2 \text{ A}, V_{GS} = 0 \text{ V}$		-0.8	-1.2	V

Dynamic (Note 4)

Total Gate Charge	Q_g	$V_{DS} = -10 \text{ V}, V_{GS} = -4.5 \text{ V}, I_D = -2.2 \text{ A}$		3.7	7.4	nC
Gate-Source Charge	Q_{gs}			0.8		
Gate-Drain Charge	Q_{gd}			1.3		
Turn-On Delay Time	$t_{d(on)}$	$V_{DD} = -10 \text{ V}, R_L = 10 \Omega, I_D \cong -1.0 \text{ A}, V_{GEN} = -4.5 \text{ V}, R_G = 6 \Omega$		13	20	ns
Rise Time	t_r			35	55	
Turn-Off Delay Time	$t_{d(off)}$			25	40	
Fall Time	t_f			25	40	
Source-Drain Reverse Recovery Time	t_{rr}	$I_F = -2.2 \text{ A}, di/dt = 100 \text{ A}/\mu\text{s}$		40	80	

3. Pulse Test: Pulse Width $\leq 300 \mu\text{s}$, Duty Cycle $\leq 2\%$.

4. Guaranteed by design, not subject to production testing.

TYPICAL ELECTRICAL CHARACTERISTICS

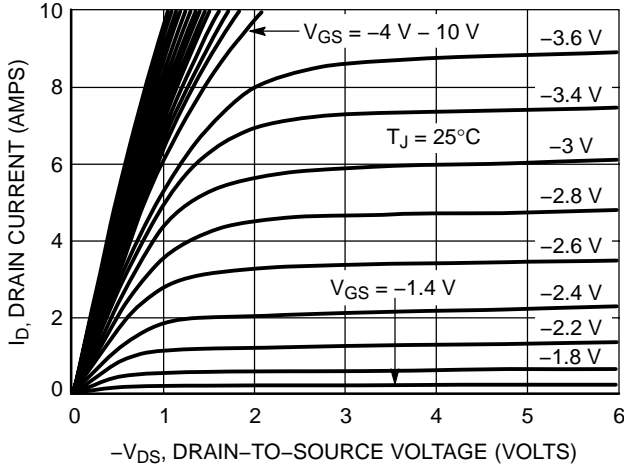

Figure 1. On-Region Characteristics

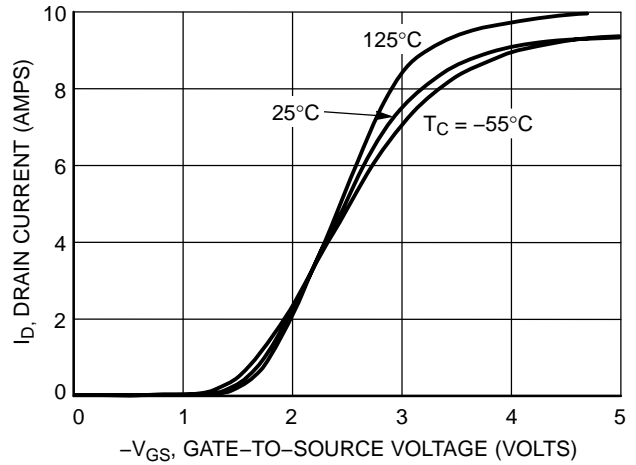

Figure 2. Transfer Characteristics

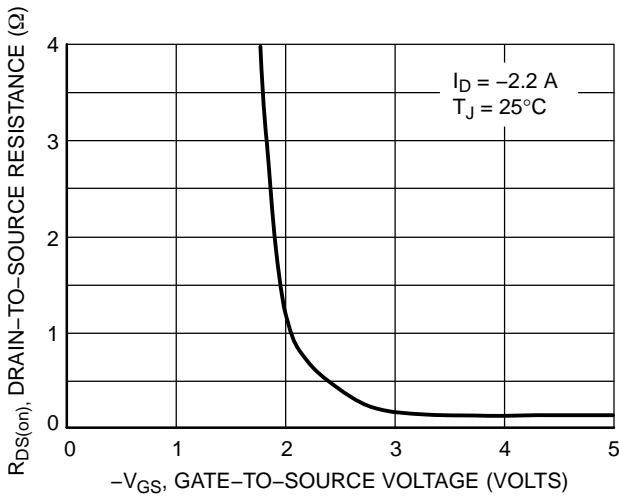

Figure 3. On-Resistance vs. Gate-to-Source Voltage

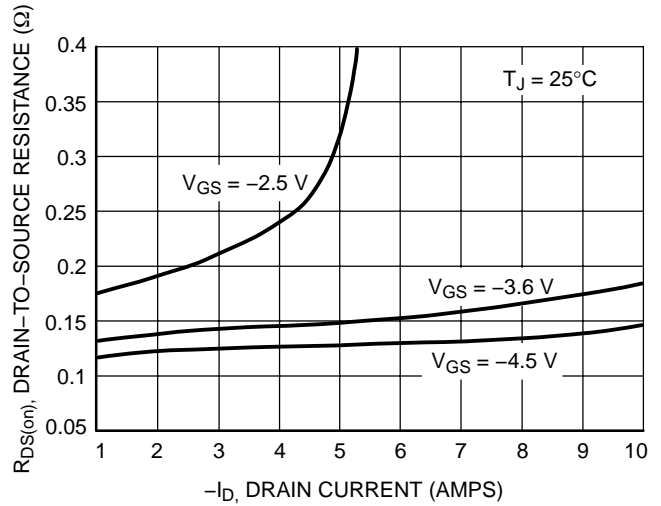

Figure 4. On-Resistance vs. Drain Current and Gate Voltage

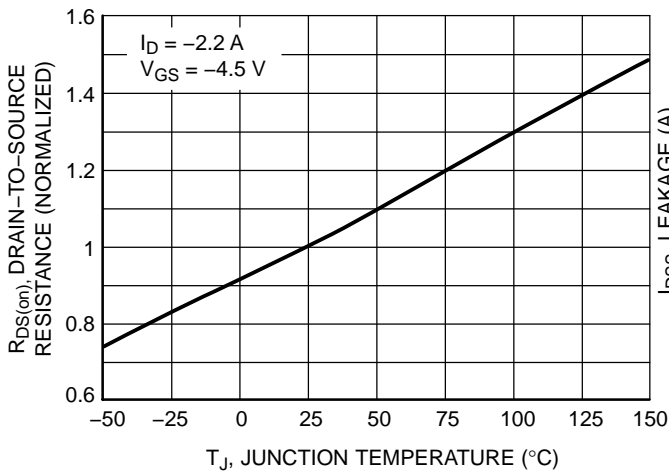

Figure 5. On-Resistance Variation with Temperature

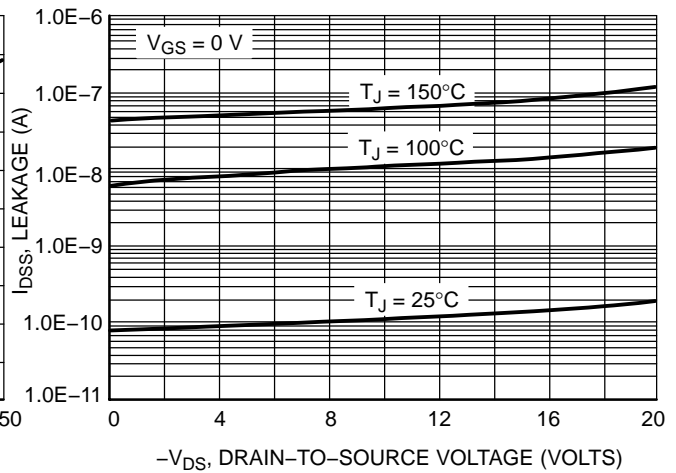

Figure 6. Drain-to-Source Leakage Current vs. Voltage

TYPICAL ELECTRICAL CHARACTERISTICS

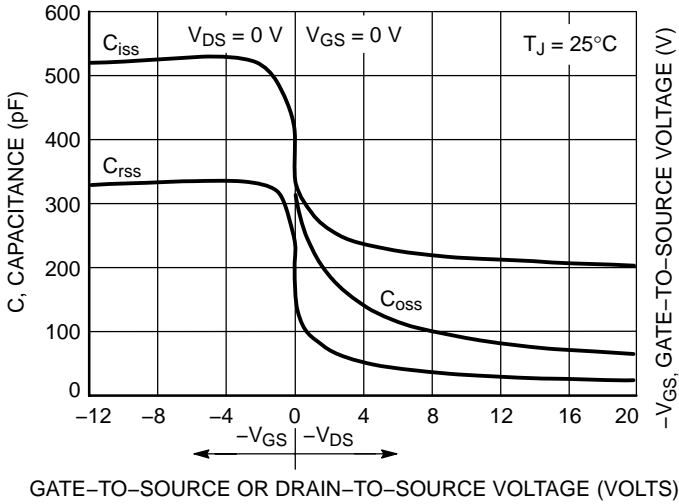

Figure 7. Capacitance Variation

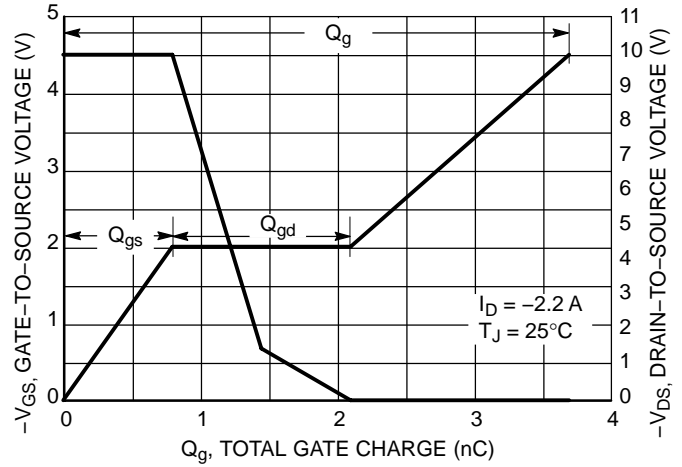

Figure 8. Gate-to-Source and Drain-to-Source Voltage vs. Total Charge

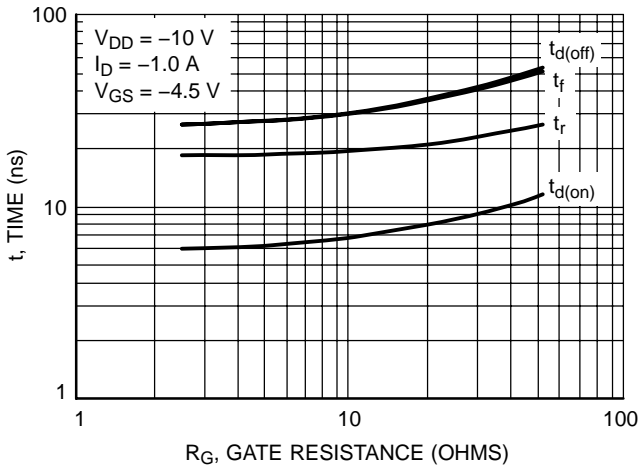

Figure 9. Resistive Switching Time Variation vs. Gate Resistance

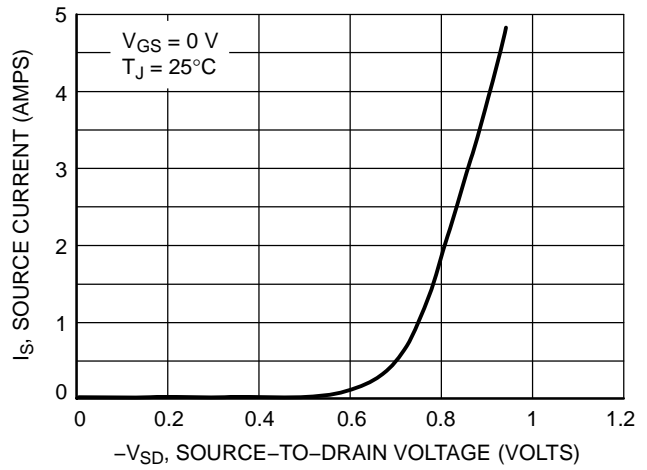

Figure 10. Diode Forward Voltage vs. Current

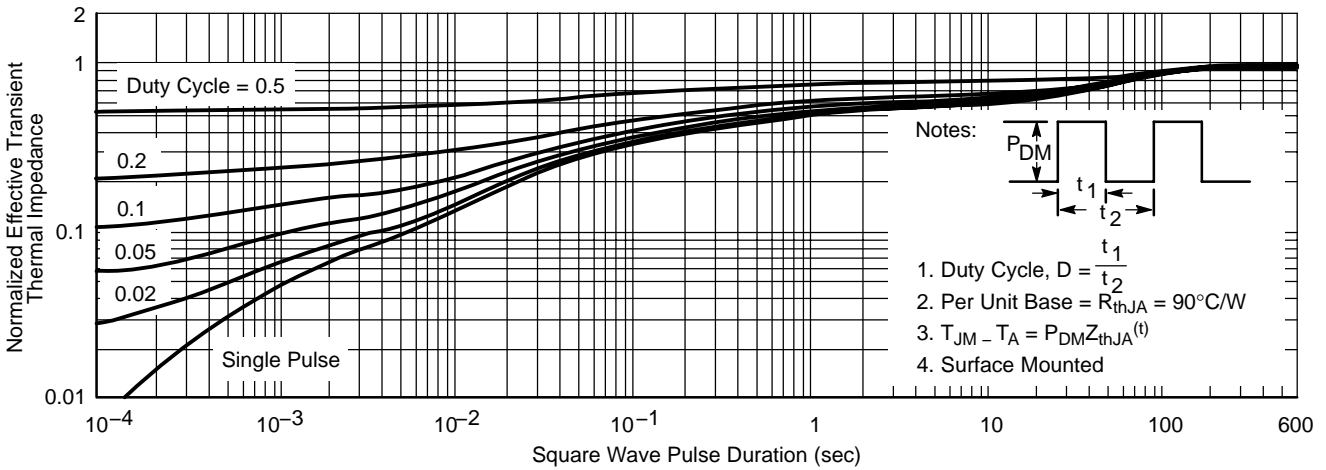

Figure 11. Normalized Thermal Transient Impedance, Junction-to-Ambient

NTHD5903

SOLDERING FOOTPRINT*

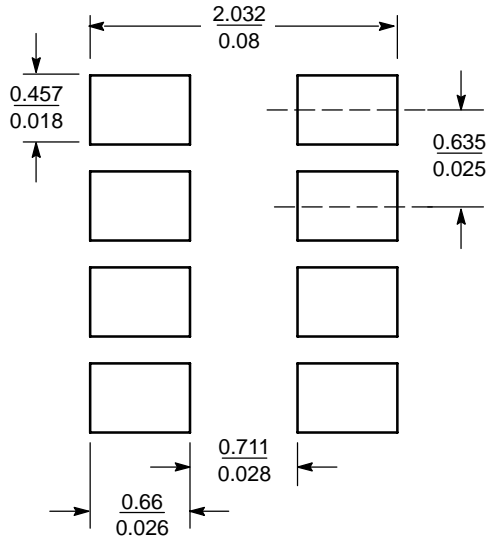

Figure 12. Basic

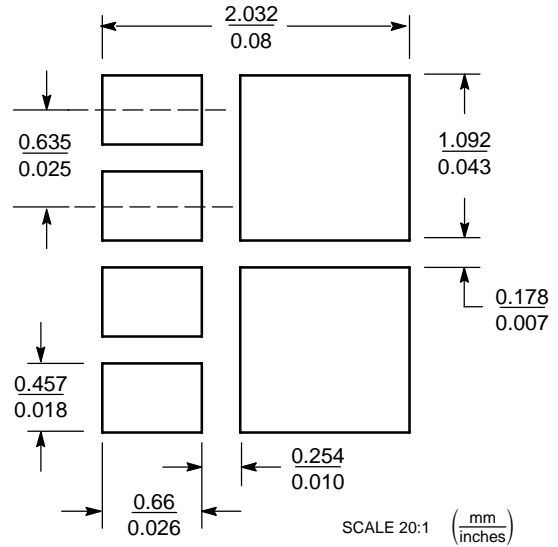

Figure 13. Style 2

*For additional information on our Pb-Free strategy and soldering details, please download the ON Semiconductor Soldering and Mounting Techniques Reference Manual, SOLDERRM/D.

BASIC PAD PATTERNS

The basic pad layout with dimensions is shown in Figure 12. This is sufficient for low power dissipation MOSFET applications, but power semiconductor performance requires a greater copper pad area, particularly for the drain leads.

The minimum recommended pad pattern shown in Figure 13 improves the thermal area of the drain connections (pins 5, 6, 7, 8) while remaining within the

confines of the basic footprint. The drain copper area is 0.0019 sq. in. (or 1.22 sq. mm). This will assist the power dissipation path away from the device (through the copper leadframe) and into the board and exterior chassis (if applicable) for the single device. The addition of a further copper area and/or the addition of vias to other board layers will enhance the performance still further.

MECHANICAL CASE OUTLINE

PACKAGE DIMENSIONS

ON Semiconductor®



ChipFET™
CASE1206A-03
ISSUE K

DATE 19 MAY 2009

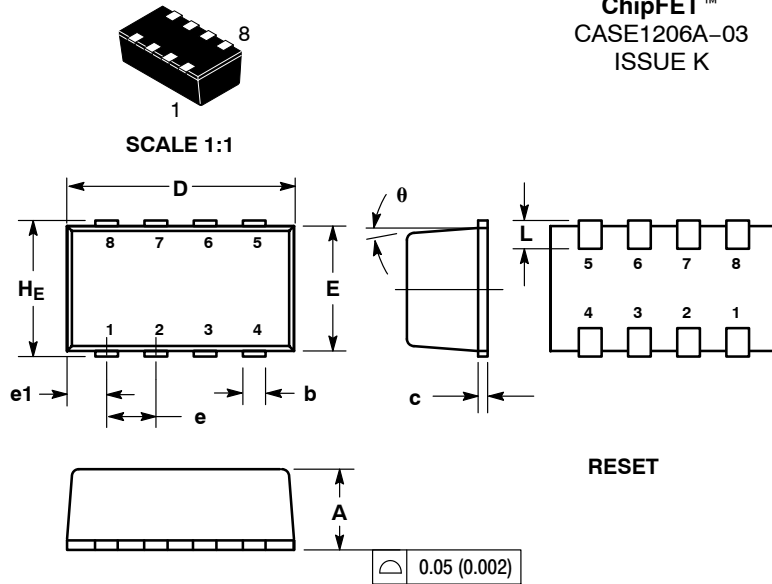

NOTES:

1. DIMENSIONING AND TOLERANCING PER ANSI Y14.5M, 1982.
2. CONTROLLING DIMENSION: MILLIMETER.
3. MOLD GATE BURRS SHALL NOT EXCEED 0.13 MM PER SIDE.
4. LEADFRAME TO MOLDED BODY OFFSET IN HORIZONTAL AND VERTICAL SHALL NOT EXCEED 0.08 MM.
5. DIMENSIONS A AND B EXCLUSIVE OF MOLD GATE BURRS.
6. NO MOLD FLASH ALLOWED ON THE TOP AND BOTTOM LEAD SURFACE.

- | | | | | | |
|---|---|---|--|---|---|
| <p>STYLE 1:
PIN 1. DRAIN
2. DRAIN
3. DRAIN
4. GATE
5. SOURCE
6. DRAIN
7. DRAIN
8. DRAIN</p> | <p>STYLE 2:
PIN 1. SOURCE 1
2. GATE 1
3. SOURCE 2
4. GATE 2
5. DRAIN 2
6. DRAIN 2
7. DRAIN 1
8. DRAIN 1</p> | <p>STYLE 3:
PIN 1. ANODE
2. ANODE
3. SOURCE
4. GATE
5. DRAIN
6. DRAIN
7. CATHODE
8. CATHODE</p> | <p>STYLE 4:
PIN 1. COLLECTOR
2. COLLECTOR
3. COLLECTOR
4. BASE
5. EMITTER
6. COLLECTOR
7. COLLECTOR
8. COLLECTOR</p> | <p>STYLE 5:
PIN 1. ANODE
2. ANODE
3. DRAIN
4. DRAIN
5. SOURCE
6. GATE
7. CATHODE
8. CATHODE</p> | <p>STYLE 6:
PIN 1. ANODE
2. DRAIN
3. DRAIN
4. GATE
5. SOURCE
6. DRAIN
7. DRAIN
8. CATHODE / DRAIN</p> |
|---|---|---|--|---|---|

SOLDERING FOOTPRINT

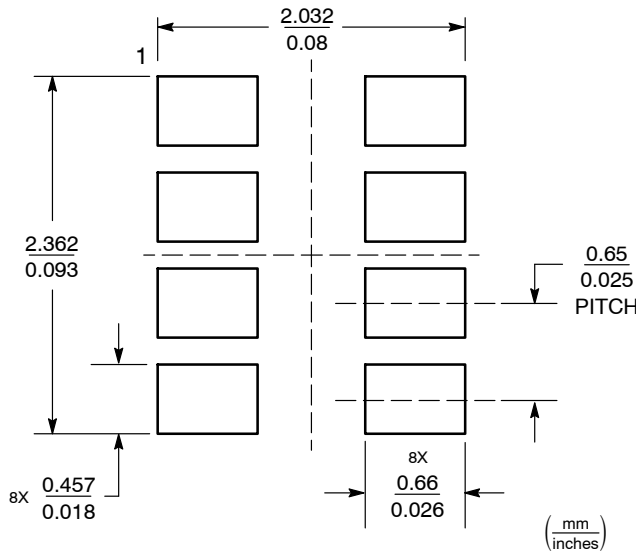

Basic Style

GENERIC MARKING DIAGRAM*

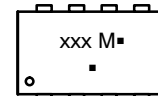

- xxx = Specific Device Code
 - M = Month Code
 - = Pb-Free Package
- (Note: Microdot may be in either location)

*This information is generic. Please refer to device data sheet for actual part marking. Pb-Free indicator, "G" or microdot "▪", may or may not be present.

OPTIONAL SOLDERING FOOTPRINTS ON PAGE 2

DOCUMENT NUMBER:	98AON03078D	Electronic versions are uncontrolled except when accessed directly from the Document Repository. Printed versions are uncontrolled except when stamped "CONTROLLED COPY" in red.
DESCRIPTION:	ChipFET	PAGE 1 OF 2

ON Semiconductor and ON are trademarks of Semiconductor Components Industries, LLC dba ON Semiconductor or its subsidiaries in the United States and/or other countries. ON Semiconductor reserves the right to make changes without further notice to any products herein. ON Semiconductor makes no warranty, representation or guarantee regarding the suitability of its products for any particular purpose, nor does ON Semiconductor assume any liability arising out of the application or use of any product or circuit, and specifically disclaims any and all liability, including without limitation special, consequential or incidental damages. ON Semiconductor does not convey any license under its patent rights nor the rights of others.

ADDITIONAL SOLDERING FOOTPRINTS*

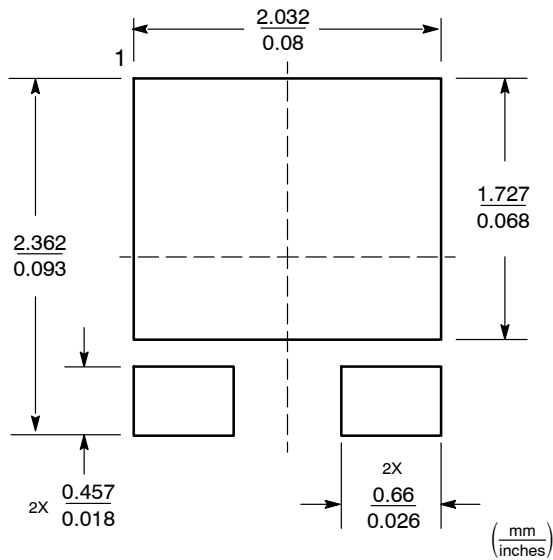

Styles 1 and 4

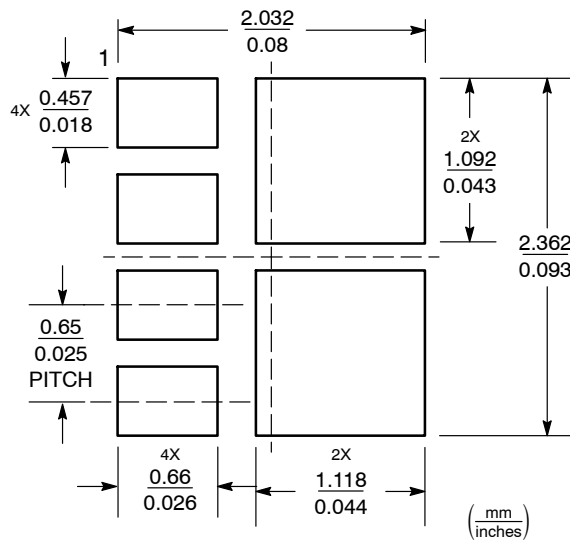

Style 2

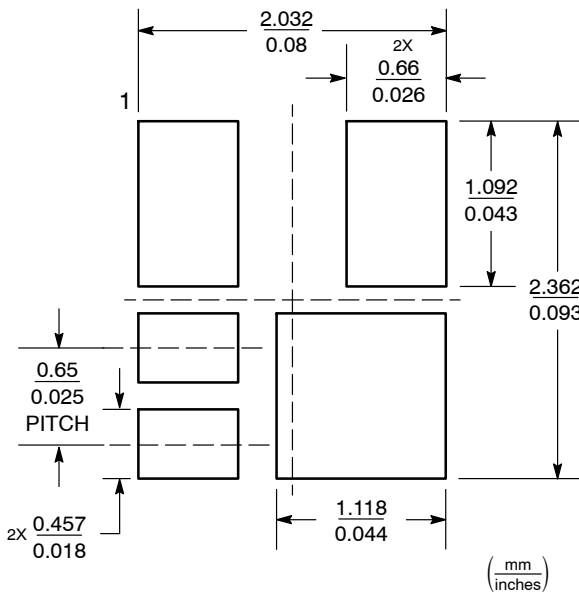

Style 3

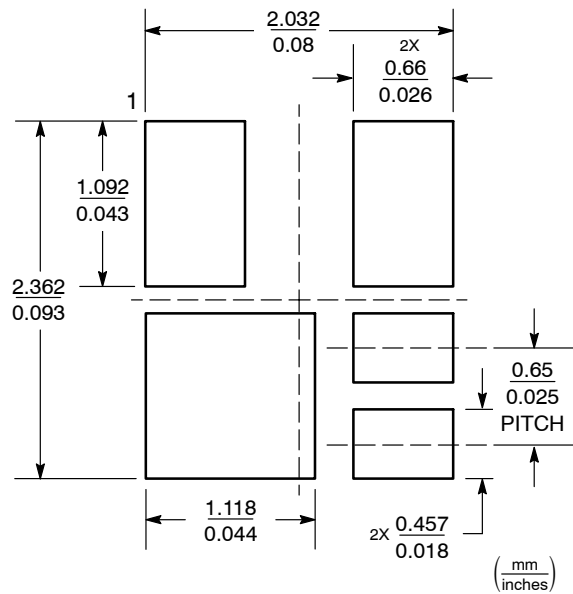

Style 5

*For additional information on our Pb-Free strategy and soldering details, please download the ON Semiconductor Soldering and Mounting Techniques Reference Manual, SOLDERRM/D.

DOCUMENT NUMBER:	98AON03078D	Electronic versions are uncontrolled except when accessed directly from the Document Repository. Printed versions are uncontrolled except when stamped "CONTROLLED COPY" in red.
DESCRIPTION:	ChipFET	PAGE 2 OF 2

ON Semiconductor and are trademarks of Semiconductor Components Industries, LLC dba ON Semiconductor or its subsidiaries in the United States and/or other countries. ON Semiconductor reserves the right to make changes without further notice to any products herein. ON Semiconductor makes no warranty, representation or guarantee regarding the suitability of its products for any particular purpose, nor does ON Semiconductor assume any liability arising out of the application or use of any product or circuit, and specifically disclaims any and all liability, including without limitation special, consequential or incidental damages. ON Semiconductor does not convey any license under its patent rights nor the rights of others.

onsemi, **Onsemi**, and other names, marks, and brands are registered and/or common law trademarks of Semiconductor Components Industries, LLC dba "**onsemi**" or its affiliates and/or subsidiaries in the United States and/or other countries. **onsemi** owns the rights to a number of patents, trademarks, copyrights, trade secrets, and other intellectual property. A listing of **onsemi**'s product/patent coverage may be accessed at www.onsemi.com/site/pdf/Patent-Marking.pdf. **onsemi** reserves the right to make changes at any time to any products or information herein, without notice. The information herein is provided "as-is" and **onsemi** makes no warranty, representation or guarantee regarding the accuracy of the information, product features, availability, functionality, or suitability of its products for any particular purpose, nor does **onsemi** assume any liability arising out of the application or use of any product or circuit, and specifically disclaims any and all liability, including without limitation special, consequential or incidental damages. Buyer is responsible for its products and applications using **onsemi** products, including compliance with all laws, regulations and safety requirements or standards, regardless of any support or applications information provided by **onsemi**. "Typical" parameters which may be provided in **onsemi** data sheets and/or specifications can and do vary in different applications and actual performance may vary over time. All operating parameters, including "Typicals" must be validated for each customer application by customer's technical experts. **onsemi** does not convey any license under any of its intellectual property rights nor the rights of others. **onsemi** products are not designed, intended, or authorized for use as a critical component in life support systems or any FDA Class 3 medical devices or medical devices with a same or similar classification in a foreign jurisdiction or any devices intended for implantation in the human body. Should Buyer purchase or use **onsemi** products for any such unintended or unauthorized application, Buyer shall indemnify and hold **onsemi** and its officers, employees, subsidiaries, affiliates, and distributors harmless against all claims, costs, damages, and expenses, and reasonable attorney fees arising out of, directly or indirectly, any claim of personal injury or death associated with such unintended or unauthorized use, even if such claim alleges that **onsemi** was negligent regarding the design or manufacture of the part. **onsemi** is an Equal Opportunity/Affirmative Action Employer. This literature is subject to all applicable copyright laws and is not for resale in any manner.

PUBLICATION ORDERING INFORMATION

LITERATURE FULFILLMENT:

Email Requests to: orderlit@onsemi.com

onsemi Website: www.onsemi.com

TECHNICAL SUPPORT

North American Technical Support:

Voice Mail: 1 800-282-9855 Toll Free USA/Canada

Phone: 011 421 33 790 2910

Europe, Middle East and Africa Technical Support:

Phone: 00421 33 790 2910

For additional information, please contact your local Sales Representative