

F1456

TX Digital VGA 1500 MHz to 2950 MHz

The F1456 is a High Gain / High Linearity 1500MHz to 2950MHz TX Digital Variable Gain Amplifier used in transmitter applications.

The F1456 TX DVGA provides 32.1dB maximum gain with +38dBm OIP3 and 3.9 dB noise figure. Up to 31.5dB gain control is achieved using the combination of a digital step attenuator (DSA) and a KLINTM RF Digital Gain Amplifier. This device uses a single 5V supply and 215mA of ICC.

This device is packaged in a 6 mm x 6 mm, 28-VFQFPN with 50Ω single-ended RF input and RF output impedances for ease of integration into the signal-path.

Competitive Advantage

In typical Base Stations, RF VGAs are used in the TX traffic paths to drive the transmit power amplifier. The F1456 TX DVGA offers very high reliability due to its construction from a monolithic silicon die in a QFN package. The F1456 is configured to provide an optimum balance of noise and linearity performance consisting of a K_{LIN}^{TM} RF amplifier, digital step attenuator (DSA) and a PA driver amplifier. The K_{LIN}^{TM} amplifier maintains the OIP3 and output P1dB performance over an extended attenuation range when compared to competitive devices.

Features

- Broadband 1500MHz to 2950MHz
- 32.1dB maximum gain
- 3.9dB NF at maximum gain (2650MHz)
- 31.5dB total gain control range, 0.5 dB step
- < 2dB overshoot between gain transitions
- Maintains flat +21.5dBm OP1dB for more than 13dB gain adjustment range
- Maintains flat +38dBm OIP3 for more than 15dB gain adjustment range
- SPI interface for DSA control
- Single 5V supply voltage
- $I_{CC} = 215mA$
- Up to +105°C T_{CASE} operating temperature
- 50Ω input and output impedance
- Standby mode for power savings
- Pin compatible 700MHz and 2100MHz versions
- 6 x 6 mm, 28-VFQFPN package

Applications

- Multi-mode, Multi-carrier Transmitters
- WiMAX and LTE Base Stations
- UMTS/WCDMA 3G Base Stations
- PHS/PAS Base Stations
- Public Safety Infrastructure

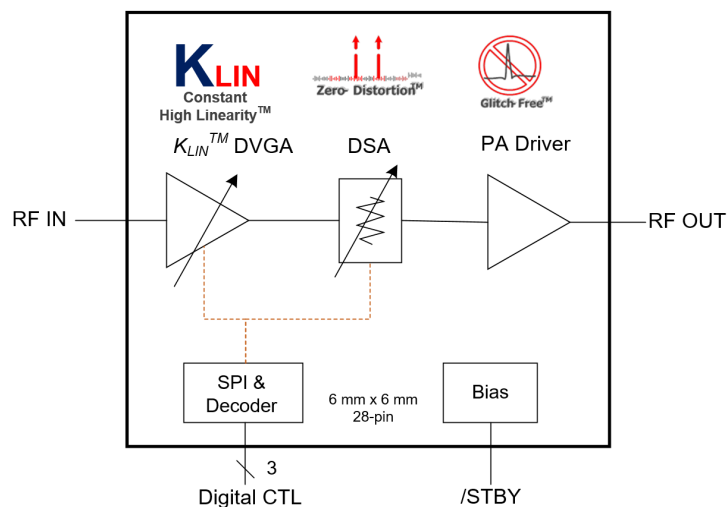

Figure 1. Block Diagram

Contents

1. Pin Information	3
1.1 Pin Assignments	3
1.2 Pin Descriptions	3
2. Specifications	4
2.1 Absolute Maximum Ratings	4
2.2 ESD Ratings	4
2.3 Recommended Operating Conditions	5
2.4 Electrical Characteristics – General	6
2.5 Electrical Characteristics – RF	7
2.6 Package Thermal Characteristics	8
3. Typical Operating Conditions	8
4. Typical Performance Graphs	9
5. Serial Port Interface	20
6. Application Information	21
6.1 Power Up Attenuation Setting	21
6.2 Chip Select (CSb)	21
6.3 Standby Mode (/STBY)	21
6.4 Power Supplies	22
6.5 Control Pin Interface	22
7. Evaluation Kit	23
7.1 Evaluation Kit Pictures	23
7.2 Evaluation Kit Schematic Circuit	24
7.3 Evaluation Kit Operation	26
7.3.1. Standby	26
7.3.2. Serial Programming Pins	26
8. Package Outline Drawings	27
9. Ordering Information	27
10. Marking Diagram	27
11. Revision History	27

1. Pin Information

1.1 Pin Assignments

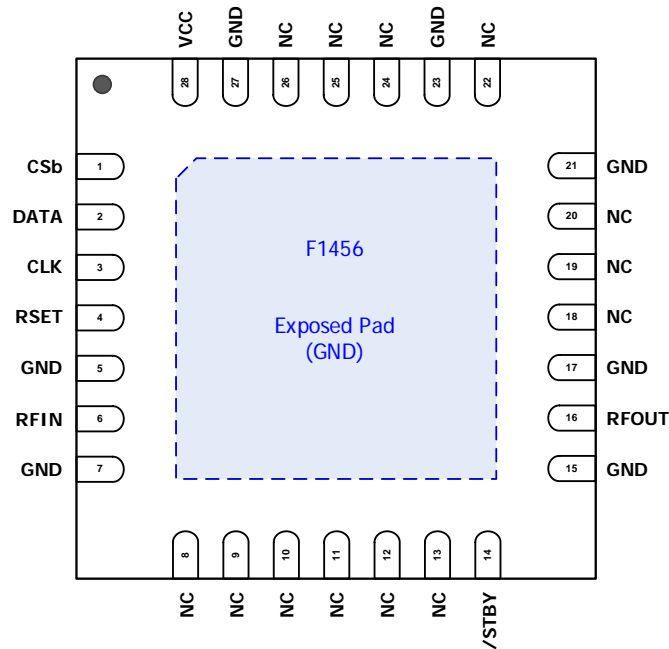

Figure 2. Pin Assignments – Top View

1.2 Pin Descriptions

Table 1. Pin Descriptions

Number	Name	Description
1	CSb	Chip Select Input: 1.8V or 3.3V logic compatible.
2	DATA	Data Input: 1.8V or 3.3V logic compatible.
3	CLK	Clock Input: 1.8V or 3.3V logic compatible.
4 ^[a]	RSET	Connect 2.2kΩ external resistor to GND to set amplifier bias.
5, 7, 15, 17, 21, 23, 27	GND	Pins internally tied to exposed paddle. Connect to ground on PCB.
6	RFIN	RF input internally matched to 50Ω. Must use external DC block.
8, 9, 10, 11, 12, 13, 18, 19, 20, 22, 24, 25, 26	NC	No internal connection. These pins can be left unconnected, voltage applied, or connected to ground (recommended).
14	/STBY	Standby pin. Device will be placed in standby mode when pin 14 is set to a logic low or when pin 14 is left floating (pulled low via internal high impedance to GND). In standby mode, SPI circuitry is still active. With a logic high applied to pin 14 the part is set to full operation mode.
16	RFOUT	RF output internally matched to 50Ω. Must use external DC block.
28	VCC	5 V Power Supply. Connect to V _{cc} and use bypass capacitors as close to the pin as possible.
	— EP	Exposed Pad. Internally connected to GND. Solder this exposed pad to a PCB pad that uses multiple ground vias to provide heat transfer out of the device into the PCB ground planes. These multiple ground vias are also required to achieve the noted RF performance.

1. External resistor on pin 4 used to optimize the overall device for DC current and linearity performance across the entire frequency band.

2. Specifications

Stresses above those listed below may cause permanent damage to the device. Functional operation of the device at these or any other conditions above those indicated in the operational section of this specification is not implied. Exposure to absolute maximum rating conditions for extended periods may affect device reliability.

2.1 Absolute Maximum Ratings

Table 2. Absolute Maximum Ratings

Parameter	Symbol	Minimum	Maximum	Unit
V _{cc} to GND	V _{CC}	-0.5	5.5	V
DATA, CSb, CLK, /STBY	V _{Cntrl}	-0.5	V _{CC}	V
RSET	I _{RSET}		+1.5	mA
RFIN externally applied DC voltage	V _{RFIN}	+1.4	+3.6	V
RFOUT externally applied DC voltage	V _{RFOUT}	V _{CC} - 0.15	V _{CC} + 0.15	V
RF Input Power (RFIN) applied for 24 hours max. [a]	P _{max_in}		+12	dBm
RF Output Power (RFOUT) present for 24 hours maximum [a]	P _{max_out}		+26	dBm
Continuous Power Dissipation	P _{diss}		1.75	W
Junction Temperature	T _j		150	°C
Storage Temperature Range	T _{st}	-65	150	°C
Lead Temperature (soldering, 10s)			260	°C

1. Exposure to these maximum RF levels can result in significantly higher I_{cc} current draw due to overdriving the amplifier stages.

2.2 ESD Ratings

ESD Model/Test	Rating	Unit
ElectroStatic Discharge – HBM (JEDEC/ESDA JS-001-2012)	2000 (Class 2)	V
ElectroStatic Discharge – CDM (JEDEC 22-C101F)	1000 (Class C3)	V

2.3 Recommended Operating Conditions

Table 3. Recommended Operating Conditions

Parameter	Symbol	Condition	Minimum	Typical	Maximum	Unit
Power Supply Voltage	V_{CC}		4.75		5.25	V
Operating Temperature Range	T_{CASE}	Exposed Paddle	-40		+105	°C
RF Frequency Range ^[a]	F_{RF}	Frequency Range	1500		2950	MHz
		High Linearity Bandwidth	2100		2700	
		Extended band for DPD	2700		2950	
Maximum Operating Average RF Output Power		$Z_S = Z_L = 50 \Omega$			14	dBm
RFIN Port Impedance	Z_{RFI}	Single-Ended		50		Ω
RFOUT Port Impedance	Z_{RFO}	Single-Ended		50		Ω

1. Device linearity is optimized over the range from 2100 MHz to 2700 MHz. Gain flatness is optimized up to 2950 MHz to account for systems with extended DPD bandwidth requirements.

2.4 Electrical Characteristics – General

See Typical Application Circuit. Unless otherwise stated, specifications apply when operated as a TX VGA, $V_{CC} = +5.0V$, $F_{RF} = 2.65GHz$, $T_{CASE} = +25^{\circ}C$, $/STBY = High$, $Z_S = Z_L = 50\Omega$, maximum gain setting. Evaluation Kit trace and connector losses are de-embedded.

Table 4. Electrical Characteristics

Parameter	Symbol	Condition	Minimum	Typical	Maximum	Unit
Logic Input High Threshold	V_{IH}	JEDEC 1.8V or 3.3V logic	1.1 ^[a]		V_{CC}	V
Logic Input Low Threshold	V_{IL}	JEDEC 1.8V or 3.3V logic	-0.3		0.8	V
Logic Current	I_{IH}, I_{IL}	SPI	-1		+1	μA
	I_{STBY}	/STBY	-10		+10	
DC Current	I_{CC}			215	245	mA
Standby Current	I_{CC_STBY}	/STBY = Low		1	2	mA
Standby Switching Time	T_{STBY}	50% /STBY control to within 0.2dB of the on state final gain value		250		ns
Gain Step	G_{STEP}	Least Significant Bit		0.5		dB
Maximum Attenuator Glitching	$ATTN_G$	Any state to state transition		2		dB
Maximum Step Error (DNL) [over voltage, temperature and attenuation states]	ERROR _{STEP}	$F_{RF} = 2.10GHz$	-0.27 ^[b]		+0.24	dB
		$F_{RF} = 2.30GHz$	-0.32		+0.26	
		$F_{RF} = 2.50GHz$	-0.36		+0.29	
		$F_{RF} = 2.65GHz$	-0.36		+0.31	
		$F_{RF} = 2.80GHz$	-0.36		+0.33	
		$F_{RF} = 2.95GHz$	-0.37		+0.36	
Maximum Absolute Error (INL)	ERROR _{ABS}			0.8		dB
Gain Settling Time ^[c]	G_{ST}	50% of CSb to 10% / 90% RF		200		ns
SPI ^[d]						
Serial Clock Speed	F_{CLOCK}				25	MHz
CSb to CLK Setup Time	T_{LS}		5			ns
CLK to Data Hold Time	T_H		5			ns
CSb Trigger to CLK Setup Time	T_{LC}		5			ns

- Items in min/max columns in **bold italics** are confirmed by Test.
- Items in min/max columns that are not bold/italics are confirmed by Design Characterization.
- Excludes SPI write time.
- SPI 3 wire bus (refer to serial Control Mode Timing diagram).

2.5 Electrical Characteristics – RF

See Typical Application Circuit. Unless otherwise stated, specifications apply when operated as a TX VGA, $V_{CC} = +5.0V$, $F_{RF} = 2.65GHz$, $T_{CASE} = +25^{\circ}C$, /STBY = High, $Z_S = Z_L = 50\Omega$, maximum gain setting. Evaluation Kit trace and connector losses are de-embedded.

Table 5. Electrical Characteristics

Parameter	Symbol	Condition	Minimum	Typical	Maximum	Unit
RF Input Return Loss	RL_{RFIN}			12		dB
RF Output Return Loss	RL_{RFOUT}			12		dB
Gain - Max Gain Setting	G_{MAX}		30.6	32.1	33.6	dB
Gain - Min Gain Setting	G_{MIN}	Max attenuation	-1.5	0	1.5	dB
Gain Flatness ^[2]	G_{FLAT}	$F_{RF} = 2100MHz$ to $2700MHz$ any 400MHz BW		0.5		dB
Noise Figure	NF	0dB attenuation		3.9		dB
		10dB attenuation		5.9		
		20dB attenuation		10.9		
		29.5dB attenuation		19.5		
		31.5dB attenuation		21.5		
Output Third Order Intercept Point	OIP3	0dB attenuation Pout = +7dBm / tone 5MHz tone separation		41.9		dBm
		6dB attenuation Pin = -21dBm / tone 5MHz tone separation		45.4		
		10dB attenuation Pin = -21dBm / tone 5MHz tone separation	35.5	43.6		
		20dB attenuation Pin = -21dBm / tone 5MHz tone separation		36.1		
		29.5dB attenuation Pin = -21dBm / tone 5MHz tone separation		27.4		
		31.5dB attenuation Pin = -21dBm / tone 5MHz tone separation		25.7		
Output 1dB Compression Point	OP1dB	0 dB attenuation		21.9		dBm
		0 dB attenuation, $T_{CASE} = +105^{\circ}C$		21.4		
		6 dB attenuation	20.9	21.9		

1. Items in min/max columns in **bold italics** are confirmed by Test.
2. Items in min/max columns that are not bold/italics are confirmed by Design Characterization.
3. Includes a positive slope feature over the noted RF range to compensate for typical system roll-off.

2.6 Package Thermal Characteristics

Table 6. Package Thermal Characteristics

Parameter	Symbol	Value	Unit
Junction to Ambient Thermal Resistance.	θ_{JA}	40	°C/W
Junction to Case Thermal Resistance. (Case is defined as the exposed paddle)	θ_{JC}	4	°C/W
Moisture Sensitivity Rating (Per J-STD-020)		MSL 1	

3. Typical Operating Conditions

Unless otherwise stated the typical operating graphs were measured under the following conditions:

- $V_{CC} = 5.0V$
- $Z_L = Z_S = 50$ Ohms Single-Ended
- $F_{RF} = 2.65GHz$
- $T_{CASE} = +25^{\circ}C$
- $/STBY = High$
- 5 MHz Tone Spacing
- Gain setting = Maximum Gain
- All temperatures are referenced to the exposed paddle
- ACLR measurements used with a Basic LTE FDD Downlink 20MHz TM1.2 Test signal
- EVM measurements used with a Basic LTE FDD Downlink 20MHz TM3.1 Test signal
- Note TN1: Atten $\leq 4dB$ Fixed Pout = 7dBm per waveform or per tone, Atten $> 4dB$ Fixed Pin = -21dBm per waveform or per tone
- Note TN2: Atten $\leq 7dB$ Fixed Pout = 10.5dBm per waveform or per tone, Atten $> 7dB$ Fixed Pin = -14.5dBm per waveform or per tone
- Evaluation Kit traces and connector losses are de-embedded

4. Typical Performance Graphs

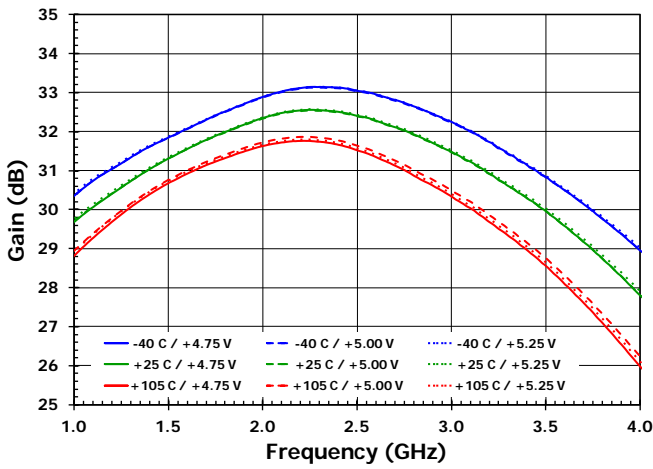

Figure 3. Maximum Gain vs. Frequency over Temp and Voltage [Attn = 0.0dB]

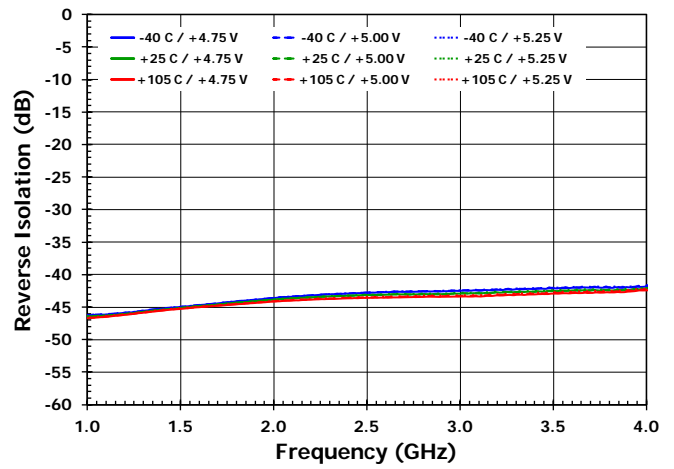

Figure 4. Reverse Isolation vs. Frequency over Temp and Voltage [Attn = 0.0dB]

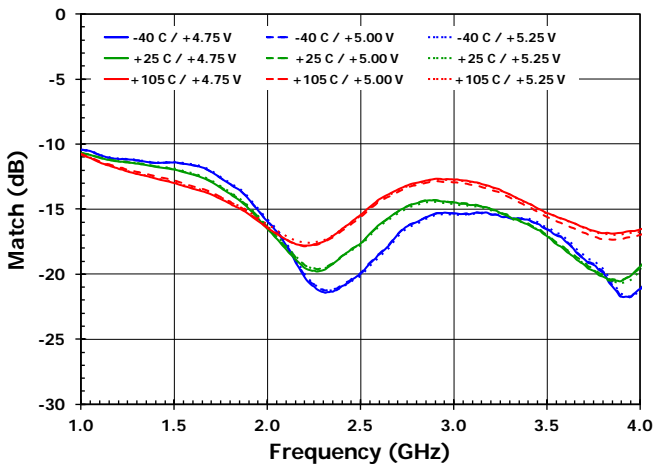

Figure 5. Input Return Loss vs. Frequency over Temp and Voltage [Attn = 0.0dB]

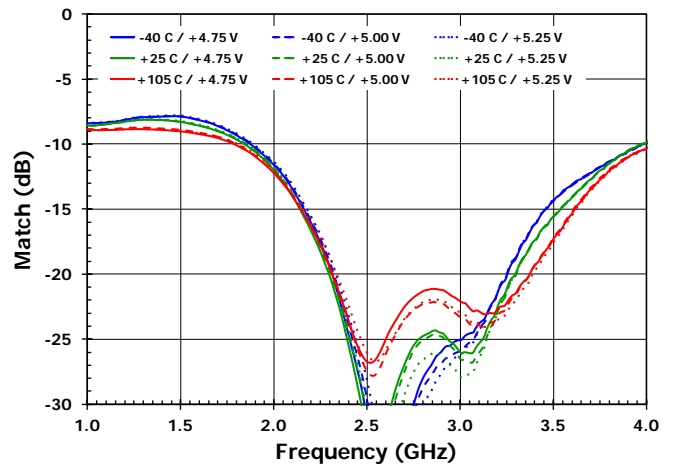

Figure 6. Output Return Loss vs. Frequency over Temp and Voltage [Attn = 0.0dB]

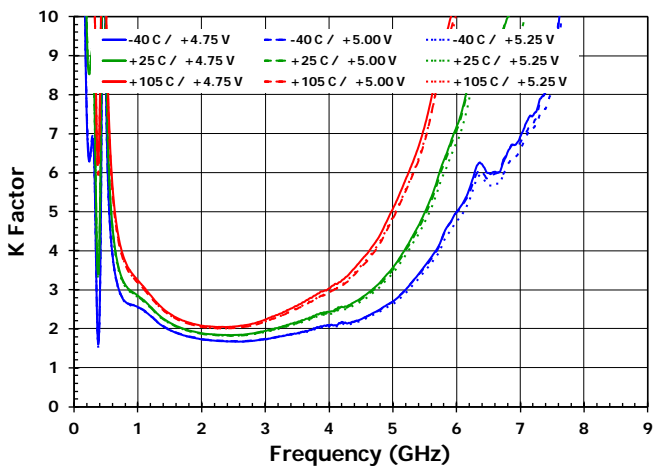

Figure 7. Stability vs. Frequency over Temperature and Voltage [Attn = 0.0dB]

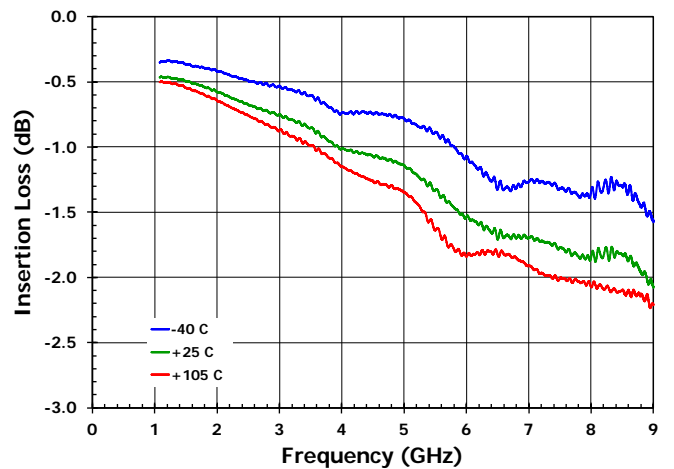

Figure 8. EvKit Insertion Loss vs. Frequency over Temperature

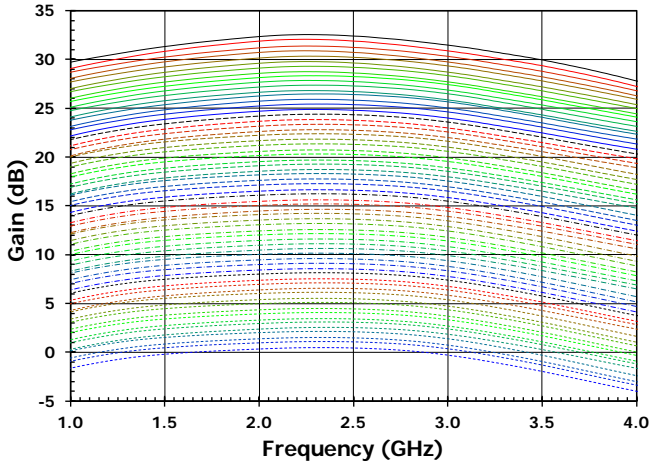

Figure 9. Gain vs. Frequency [+25°C, All States]

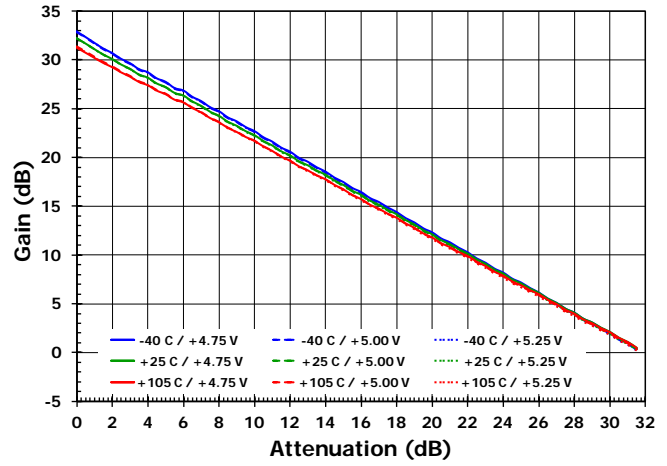

Figure 10. Gain vs. Attenuation over Temperature and Voltage [2.65GHz]

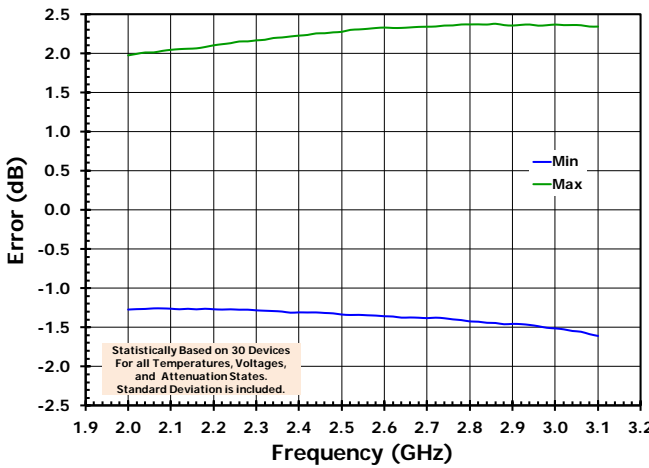

Figure 11. Worst Case Attenuator Absolute Accuracy vs. Freq [All parameters]

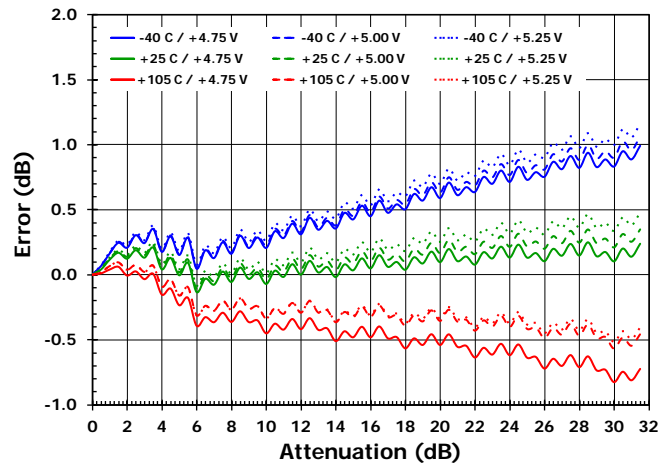

Figure 12. Attenuator Absolute Accuracy vs. Atten over Temp and Voltage [2.65GHz]

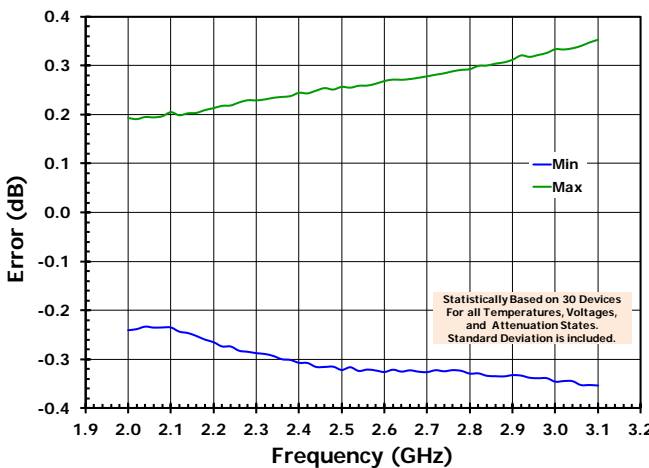

Figure 13. Worst Case Step Accuracy vs. Freq [All parameters]

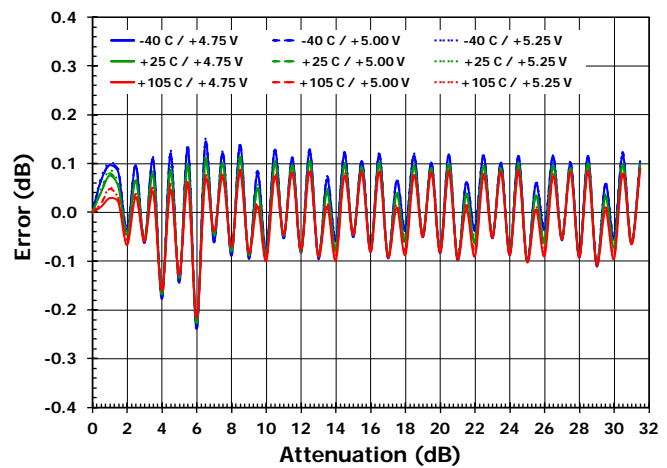

Figure 14. Step Accuracy vs. Attenuation over Temperature and Voltage [2.65GHz]

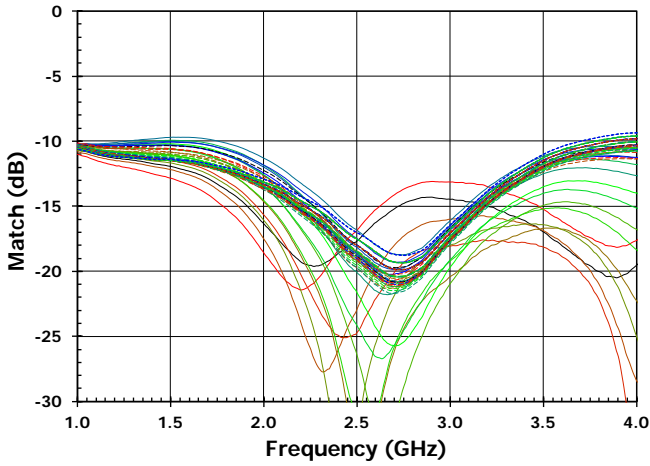

Figure 15. Input Return Loss vs. Frequency [+25°C, All states]

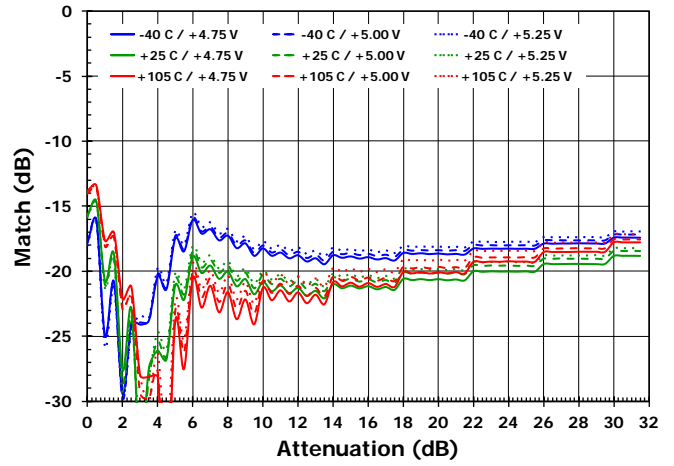

Figure 16. Input Return Loss vs. Attenuation over Temperature and Voltage [2.65GHz]

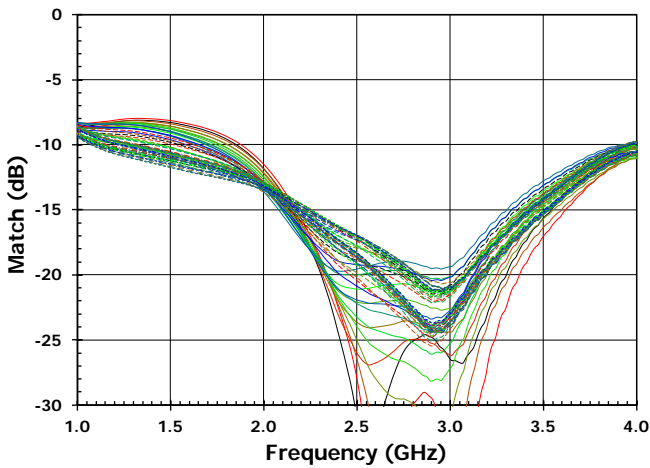

Figure 17. Output Return Loss vs. Frequency [+25°C, All states]

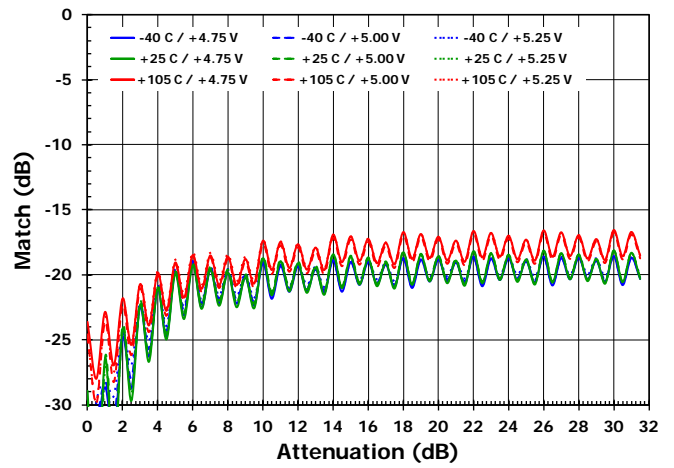

Figure 18. Output Return Loss vs. Attenuation over Temperature and Voltage [2.65GHz]

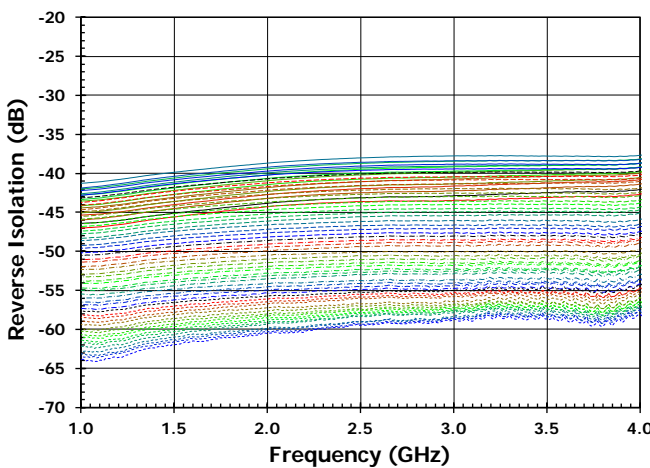

Figure 19. Reverse Isolation vs. Frequency [+25°C, All states]

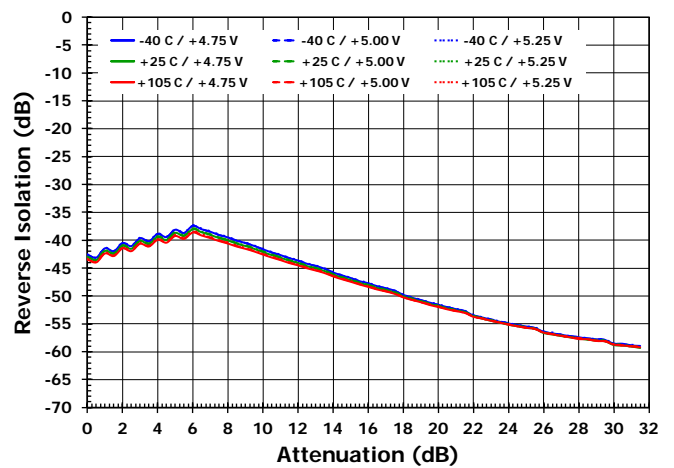

Figure 20. Reverse Isolation vs. Attenuation over Temperature and Voltage [2.65GHz]

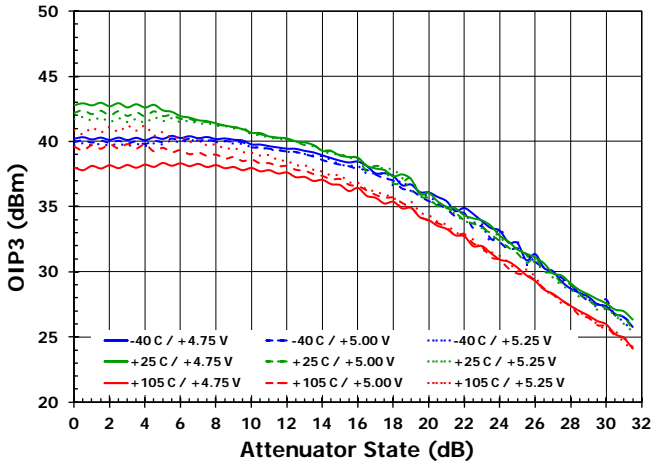

Figure 21. Output IP3 vs. Attn over Temp and Voltage [2.3GHz] (Test Note TN1)

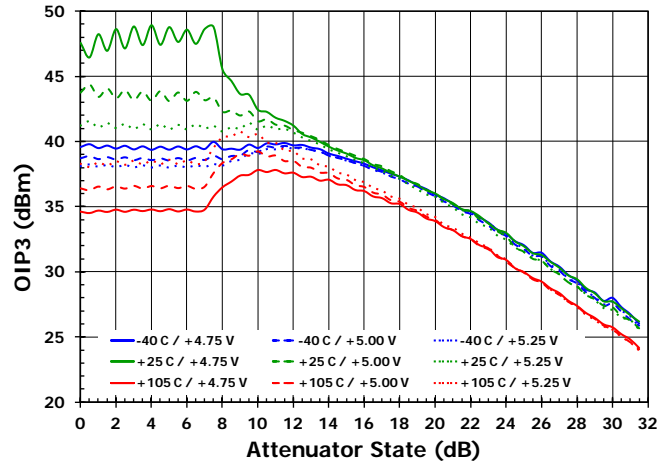

Figure 22. Output IP3 vs. Attn over Temp and Voltage [2.3GHz] (Test Note TN2)

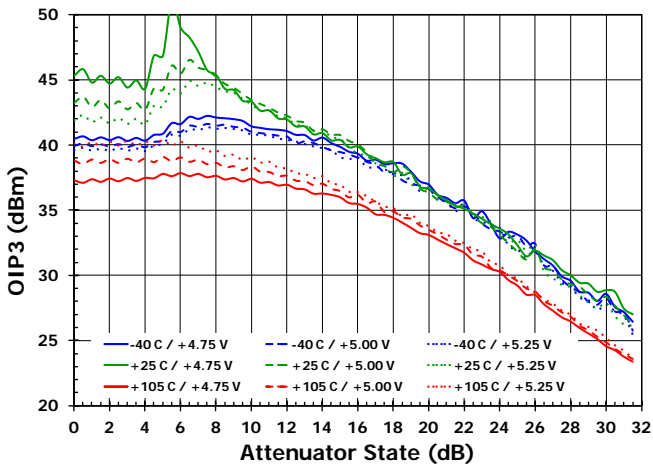

Figure 23. Output IP3 vs. Attn over Temp and Voltage [2.5GHz] (Test Note TN1)

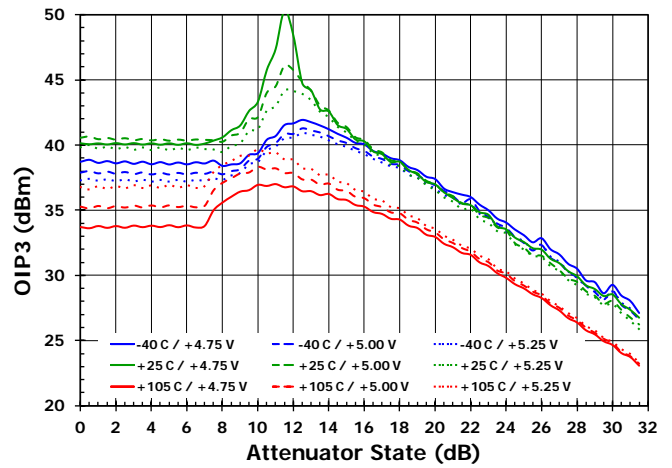

Figure 24. Output IP3 vs. Attn over Temp and Voltage [2.5GHz] (Test Note TN2)

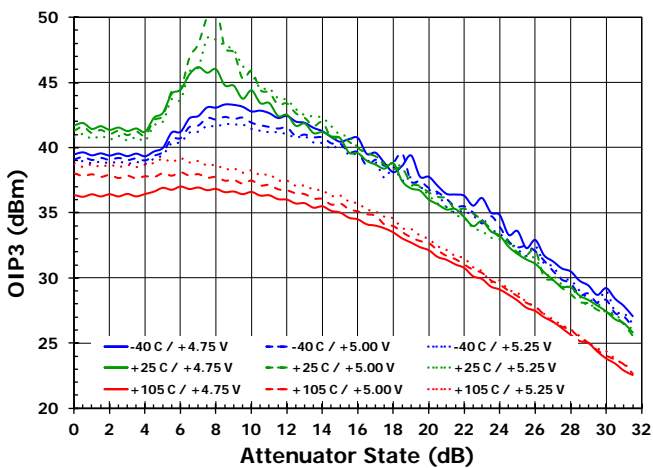

Figure 25. Output IP3 vs. Attn over Temp and Voltage [2.65GHz] (Test Note TN1)

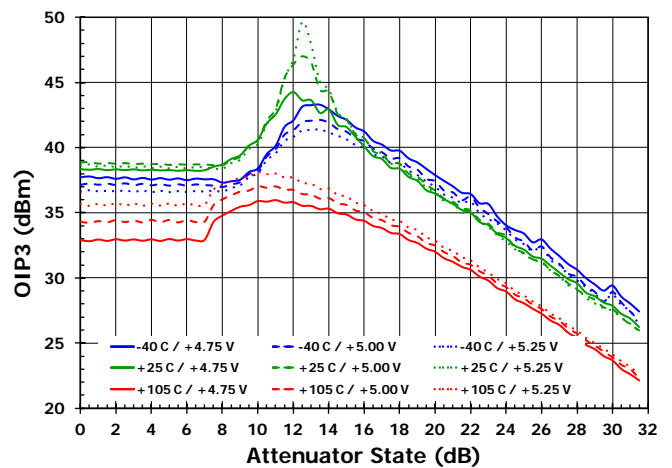

Figure 26. Output IP3 vs. Attn over Temp and Voltage [2.65GHz] (Test Note TN2)

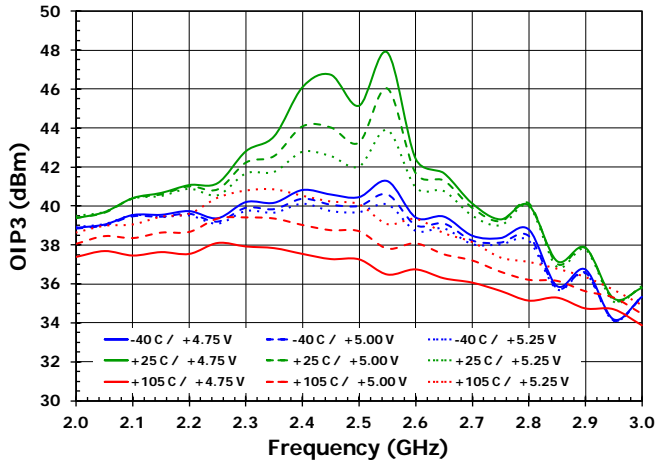

Figure 27. Output IP3 vs. Frequency over Temperature and Voltage [Attn = 0.0dB]

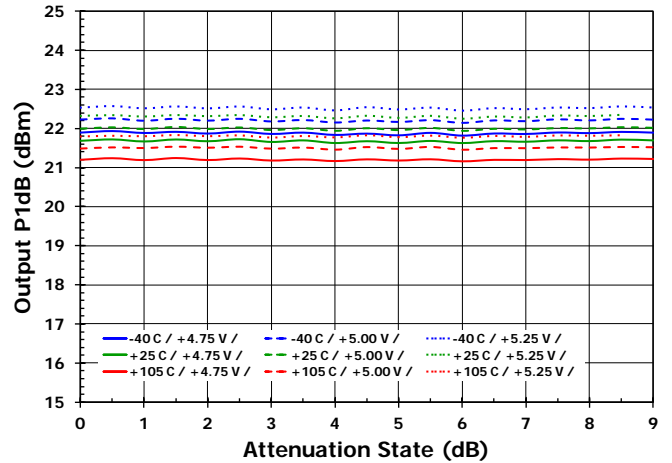

Figure 28. Output P1dB vs. Attenuation over Temperature and Voltage [2.3GHz]

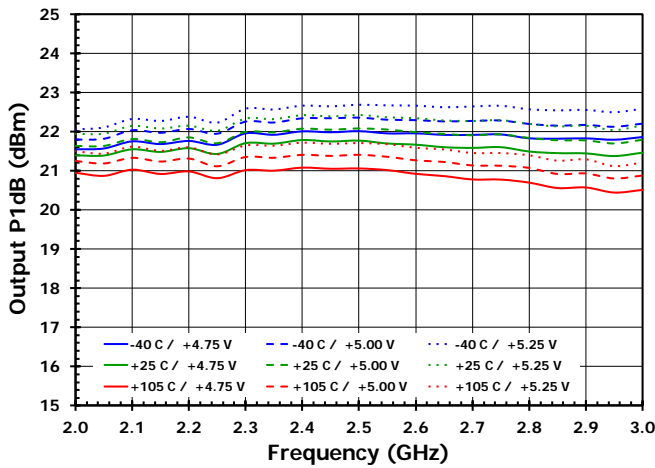

Figure 29. Output P1dB vs. Frequency over Temp and Voltage [Attn = 0.0dB]

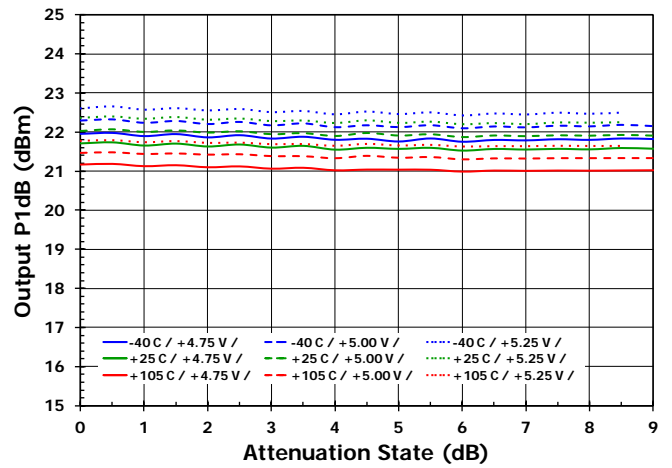

Figure 30. Output P1dB vs. Attenuation over Temp and Voltage [2.5GHz]

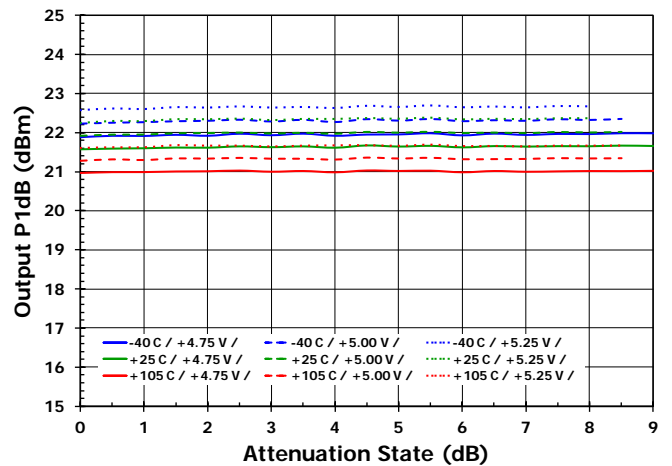

Figure 31. Output P1dB vs. Attenuation over Temp and Voltage [2.65GHz]

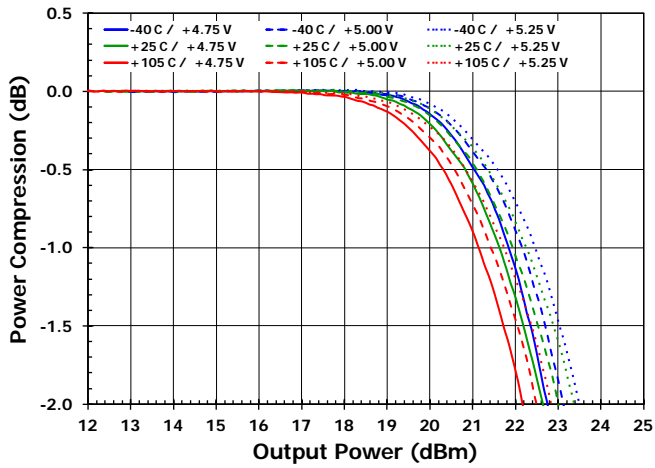

Figure 32. Gain Compression vs. Pout over Temperature and Voltage [2.3GHz]

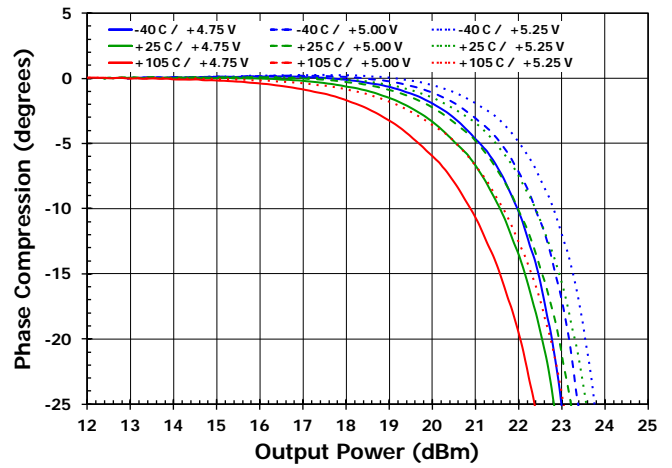

Figure 33. Phase Compression vs. Pout over Temperature and Voltage [2.3GHz]

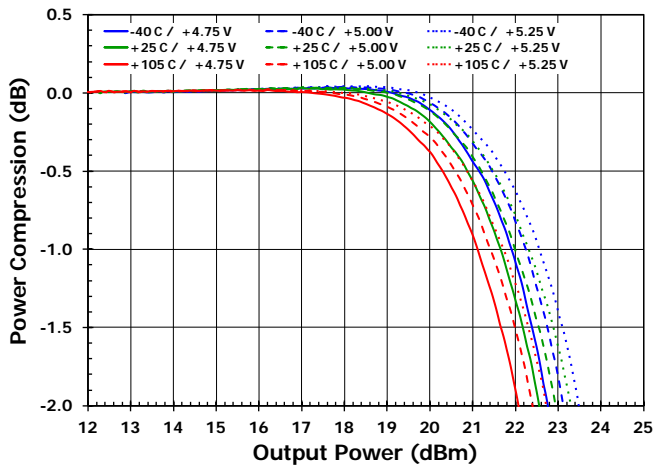

Figure 34. Gain Compression vs. Pout over Temperature and Voltage [2.5GHz]

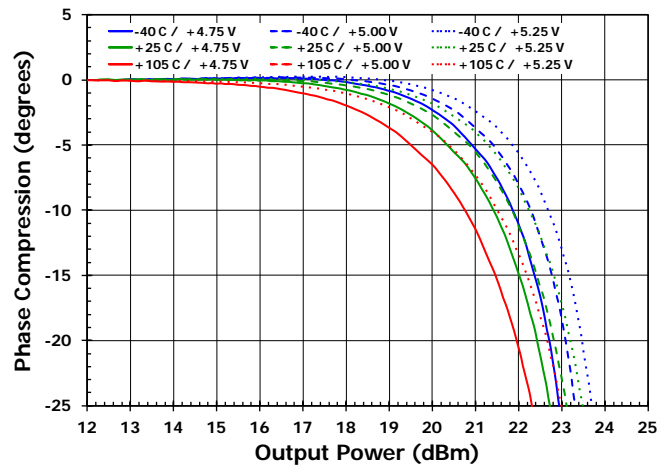

Figure 35. Phase Compression vs. Pout over Temperature and Voltage [2.5GHz]

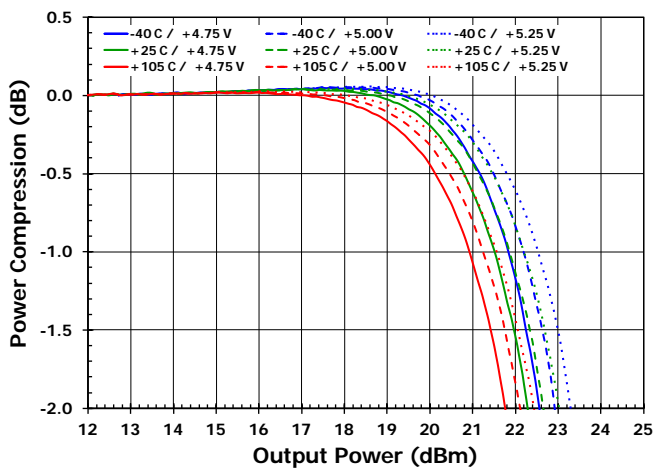

Figure 36. Gain Compression vs. Pout over Temperature and Voltage [2.65GHz]

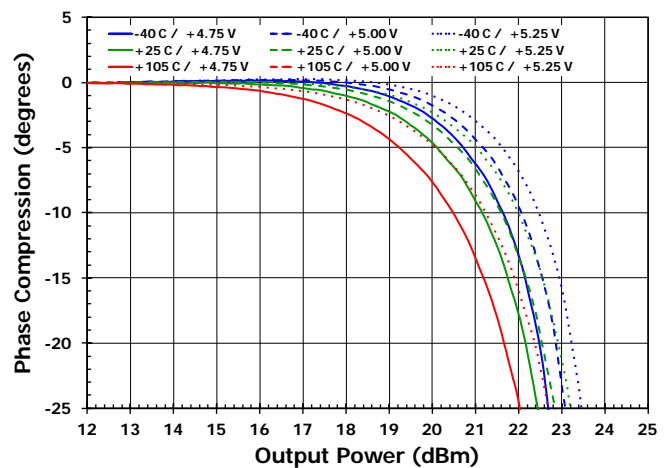

Figure 37. Phase Compression vs. Pout over Temperature and Voltage [2.65GHz]

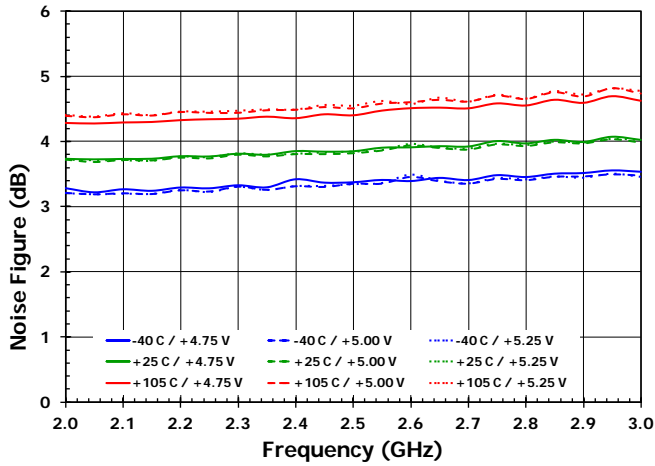

Figure 38. Noise Figure vs. Frequency over Temperature and Voltage [Attn = 0.0dB]

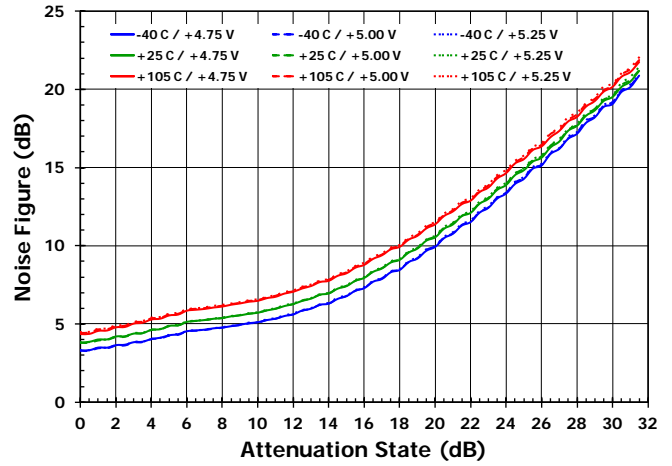

Figure 39. Noise Figure vs. Attenuation over Temperature and Voltage [2.3GHz]

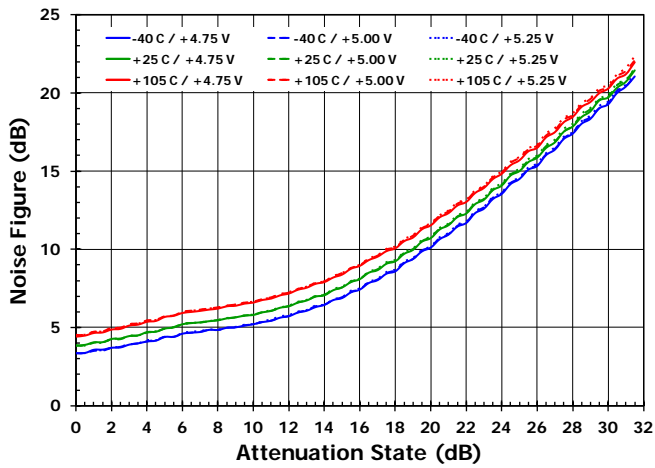

Figure 40. Noise Figure vs. Attenuation over Temperature and Voltage [2.5GHz]

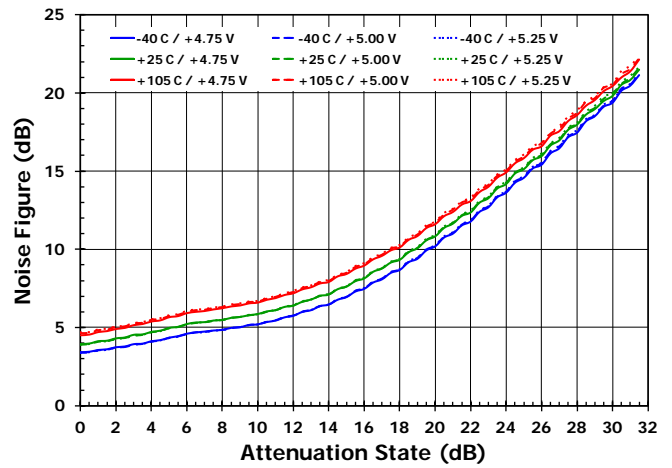

Figure 41. Noise Figure vs. Attenuation over Temperature and Voltage [2.65GHz]

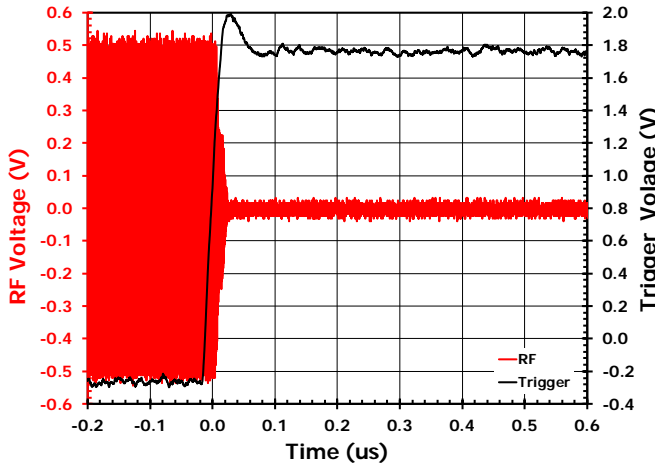

Figure 42. Switching Speed 0.0 to 31.5 dB

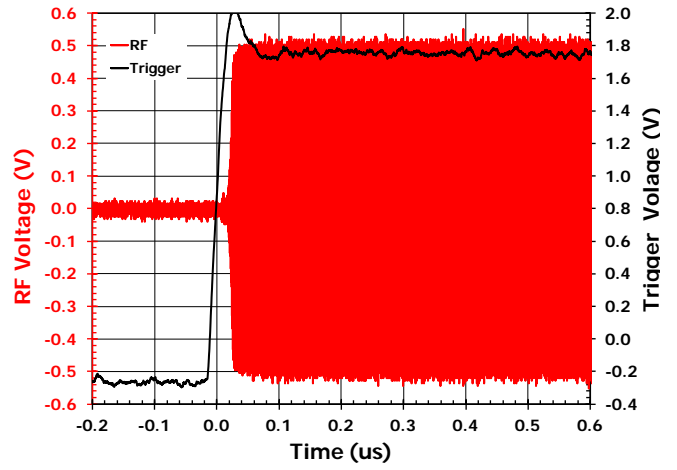

Figure 43. Switching Speed 31.5 to 0.0 dB

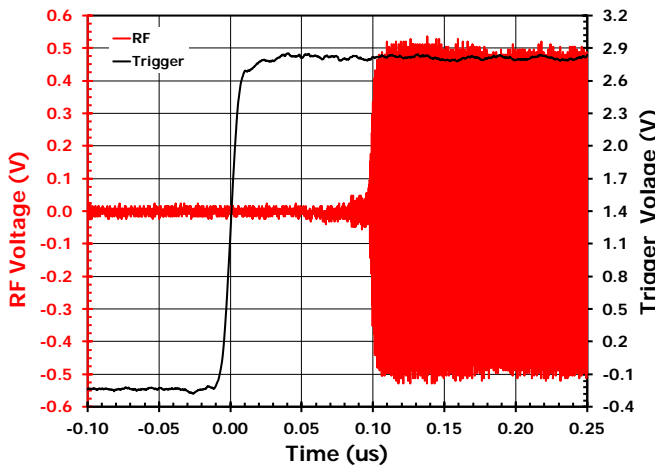

Figure 44. Switching Speed Standby Mode to Full Operation Mode

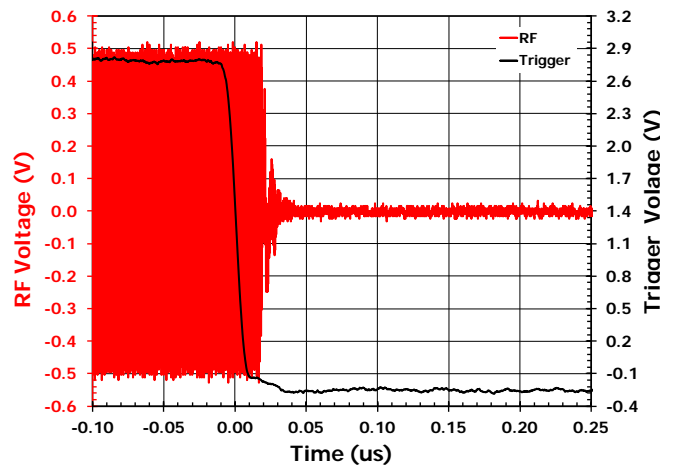

Figure 45. Switching Speed Full Operation Mode to Standby Mode

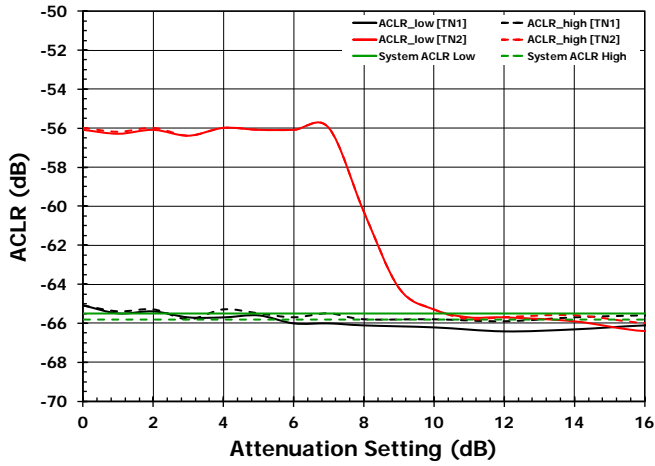

Figure 46. ACLR vs. Attn [2.3GHz]

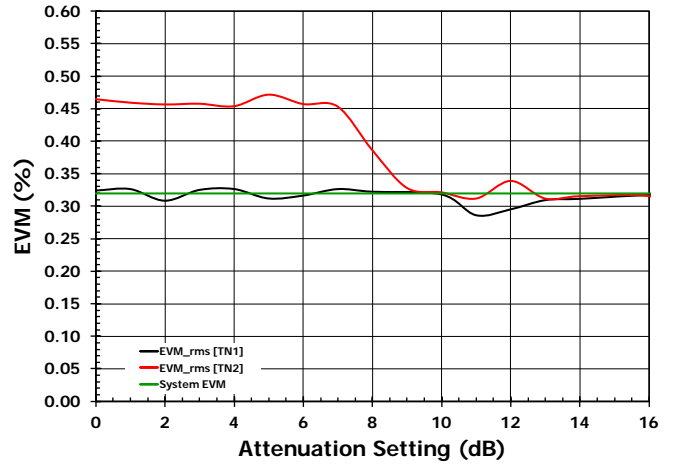

Figure 47. EVM (RMS) vs. Attn [2.3GHz]

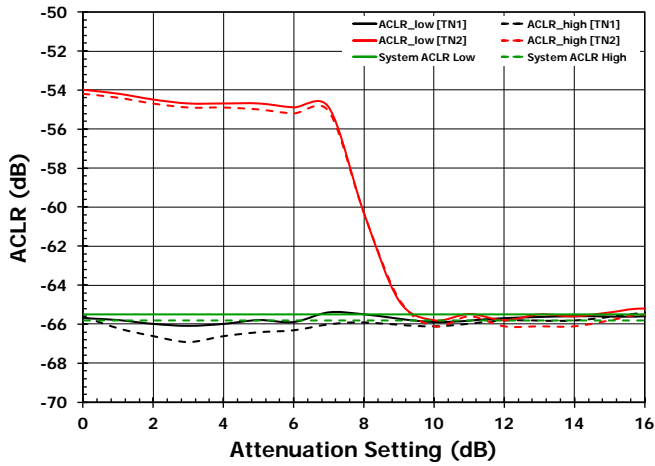

Figure 48. ACLR vs. Attn [2.5GHz]

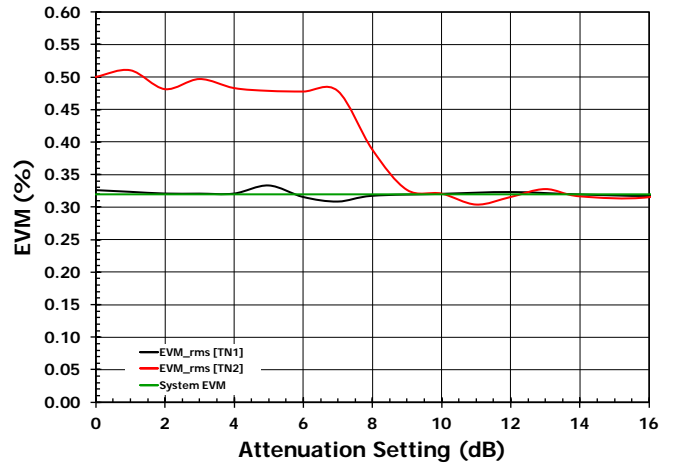

Figure 49. EVM (RMS) vs. Attn [2.5GHz]

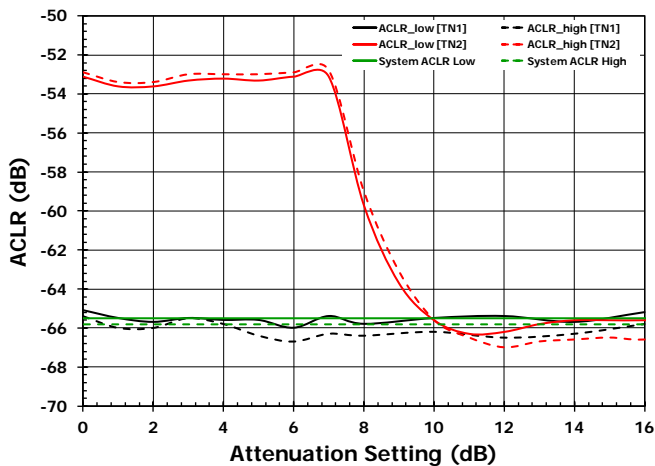

Figure 50. ACLR vs. Attn [2.65GHz]

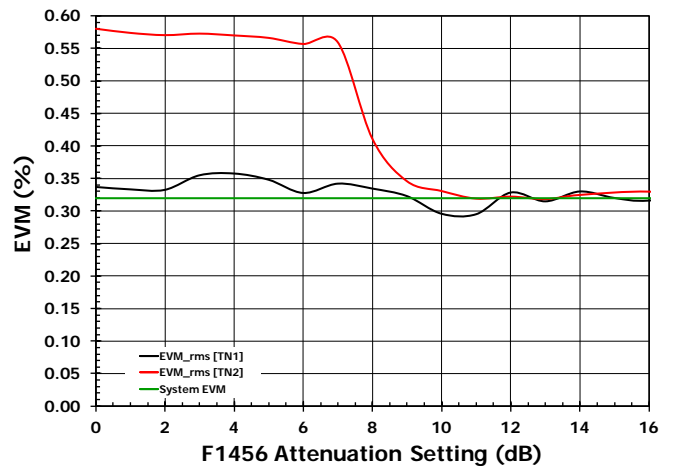

Figure 51. EVM (RMS) vs. Attn [2.65GHz]

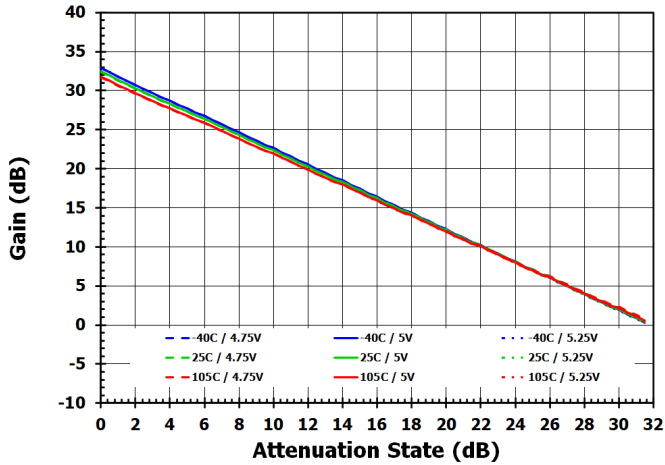

Figure 52. Gain Vs. Attenuation [1.8GHz]

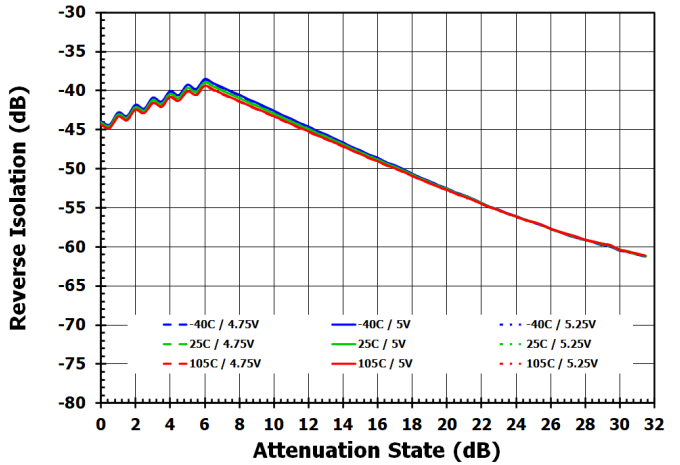

Figure 53. Reverse Isolation Vs. Attenuation [1.8GHz]

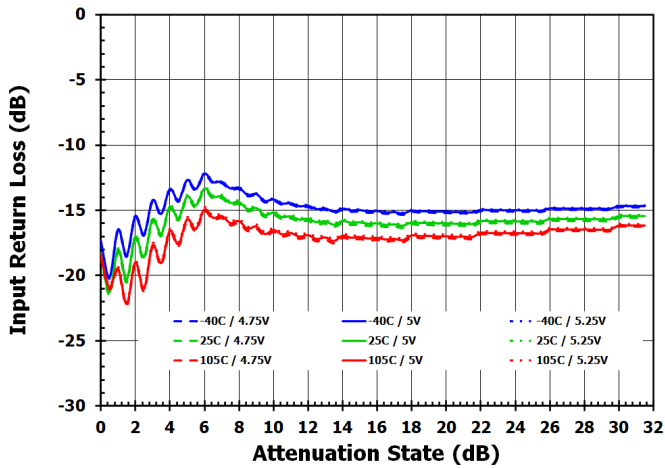

Figure 54. Input Return Loss Va. Attenuation [1.8GHz]

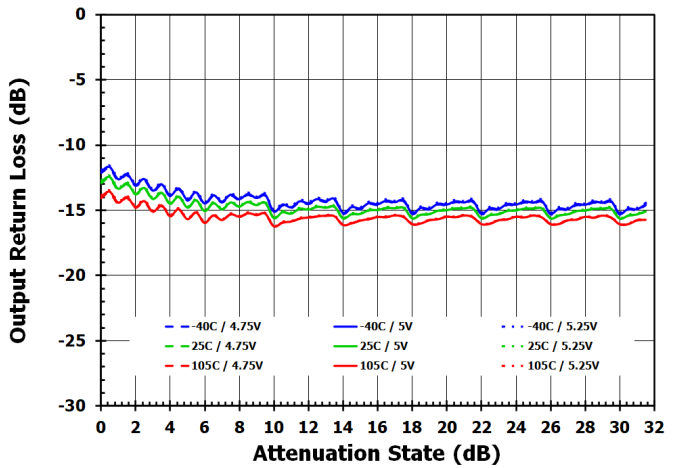

Figure 55. Output Return Loss Vs. Attenuation [1.8GHz]

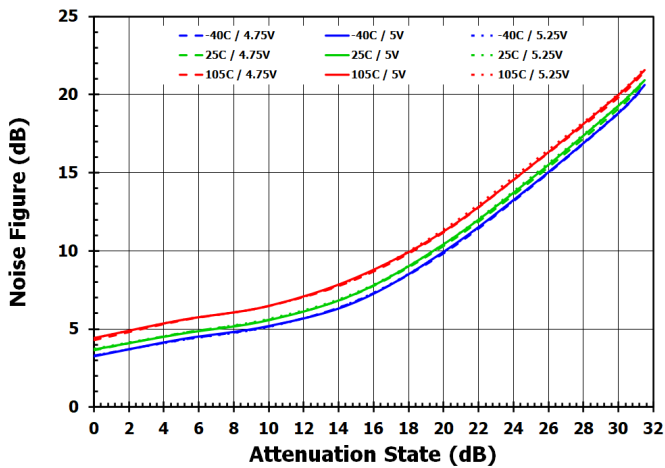

Figure 56. Noise Figure Vs. Attenuation [1.8GHz]

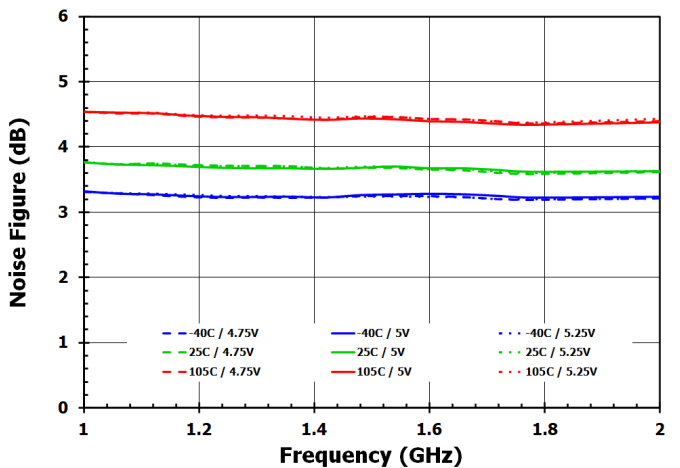

Figure 57. Noise Figure Vs. Frequency [Low Band]

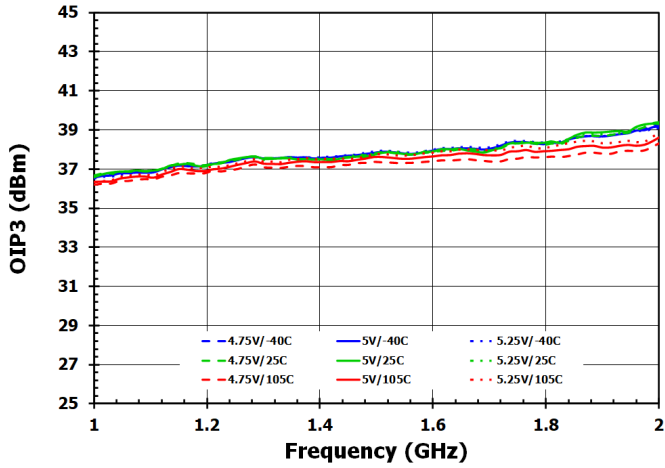

Figure 58. Output IP3 Vs. Frequency [Low Band]

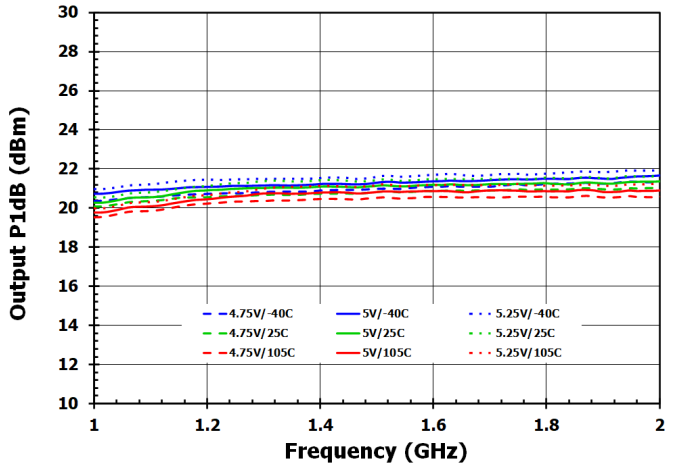

Figure 59. Output P1dB Vs. Frequency [Low Band]

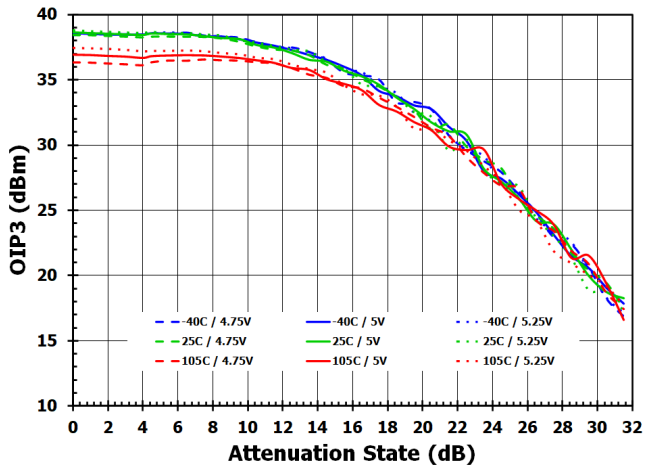

Figure 60. Output IP3 Vs. Attenuation - TN1 [1.8GHz]

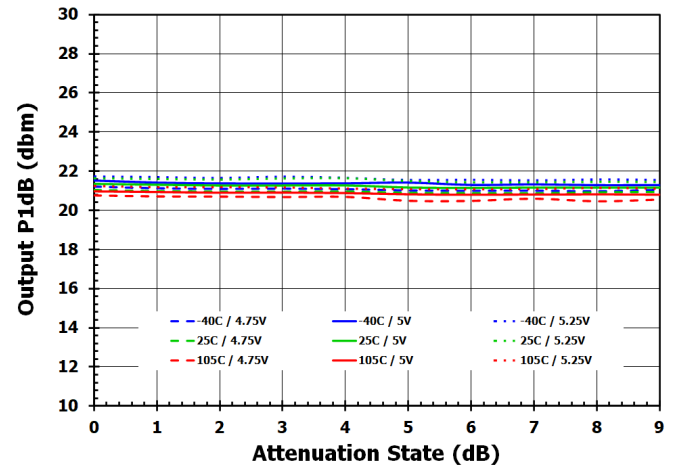

Figure 61. Output P1dB Vs. Attenuation [1.8GHz]

5. Serial Port Interface

Serial data is formatted as a 6-bit word clocking data in MSB first.

Table 7. Attenuation Word Truth Table

Control Bit						Attenuator Setting
D5	D4	D3	D2	D1	D0	
1	1	1	1	1	1	0.0dB
1	1	1	1	1	0	0.5dB
1	1	1	1	0	1	1.0dB
1	1	1	0	1	1	2.0dB
1	1	0	1	1	1	4.0dB
1	0	1	1	1	1	8.0dB
0	1	1	1	1	1	16.0dB
0	0	0	0	0	0	31.5dB

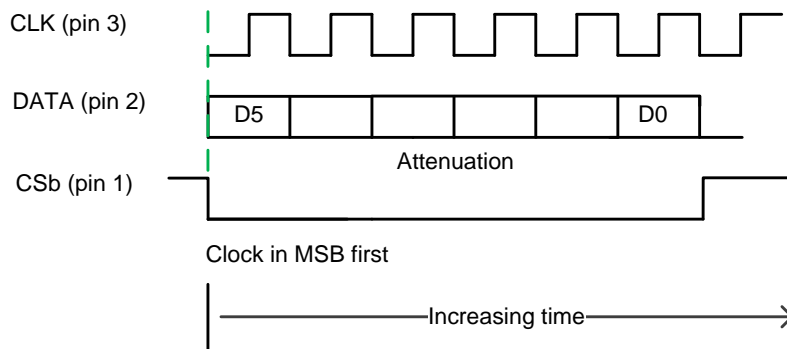

Figure 62. Serial Register Timing Diagram

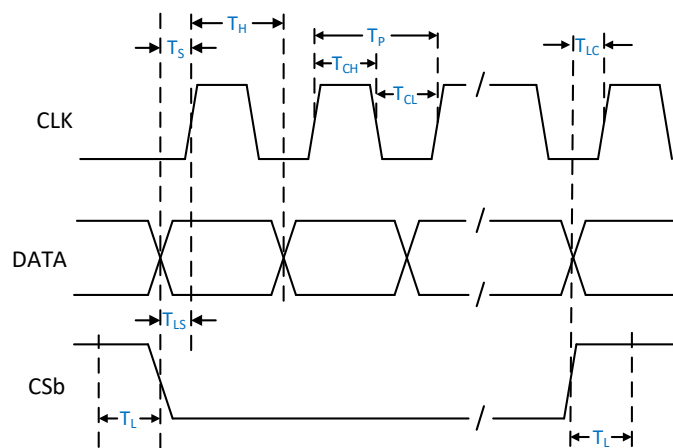

Figure 63. SPI Timing Diagram

Table 8. SPI Timing Diagram Values for Figure 63

Parameter	Symbol	Test Condition	Minimum	Typical	Maximum	Unit
CLK Frequency	F_C				25	MHz
CLK High Duration Time	T_{CH}		20			ns
CLK Low Duration Time	T_{CL}		20			ns
DATA to CLK Setup Time	T_S		5			ns
CLK Period ^[a]	T_P		40			ns
CLK to DATA Hold Time	T_H		5			ns
CSb to CLK Setup Time	T_{LS}		5			ns
CSb Trigger Pulse Width	T_L		10			ns
CSb Trigger to CLK Setup Time ^[b]	T_{LC}		5			ns

1. $(T_{CH} + T_{CL}) \geq 1/F_C$
2. Once all desired DATA is clocked in, T_{LC} represents the time a CSb high needs to occur before any subsequent CLK signals.

Table 9. Standby Truth Table

/STBY (pin 14)	Condition
0 V	Amplifier OFF with SPI powered ON
V_{CC}	Full operation

6. Application Information

The F1456 has been optimized for use in high performance RF applications from 1500MHz to 2950MHz. The device maintains good performance outside of the optimized band as shown by the Typical Performance Characteristics.

6.1 Power Up Attenuation Setting

When the part is initially powered up, the default VGA setting is the 31.5dB [000000] attenuation state.

6.2 Chip Select (CSb)

When CSb is set to logic high, the CLK input is disabled. When CSb is set to logic low, the CLK input is enabled and the DATA word can be programmed into the shift registers. The programmed word is then latched into the F1456 on the CSb rising edge (refer Figure 63). The operation of the SPI bus is independent of the /STBY pin setting (see Standby Mode section below).

6.3 Standby Mode (/STBY)

The F1456 has a power down feature for power savings which is on Pin 14. For normal operation pin 14 must be set to a logic high. When a logic low is applied to pin 14 the amplifier is placed in standby mode. The Standby mode is a high isolation state. The level of this isolation is not specified and is dependent on the device and attenuation state. In Standby mode the SPI bus is operational and the device attenuation setting can be programmed. Therefore, the device will present the desired attenuation when it is enabled.

6.4 Power Supplies

A common V_{CC} power supply should be used for all power supply pins. To minimize noise and fast transients decoupling capacitors to all supply pins. Supply noise can degrade noise figure and fast transients can trigger ESD clamps causing them to fail. Supply voltage change or transients should have a slew rate smaller than $1\text{ V} / 20\mu\text{s}$. In addition, all control pins should remain at $0\text{ V} (\pm 0.3\text{V})$ while the supply voltage ramps or while it returns to zero.

6.5 Control Pin Interface

If control signal integrity is a concern and clean signals cannot be guaranteed due to overshoot, undershoot, ringing, etc., the following circuit at the input of each control pin is recommended. This applies to SPI and control pins 1, 2, 3 and 14 as shown below. Note the recommended resistor and capacitor values do not necessarily match the EV kit BOM for the case of poor control signal integrity. For multiple devices driven by a single control line, the component values will need to be adjusted accordingly so as not to load down the control line.

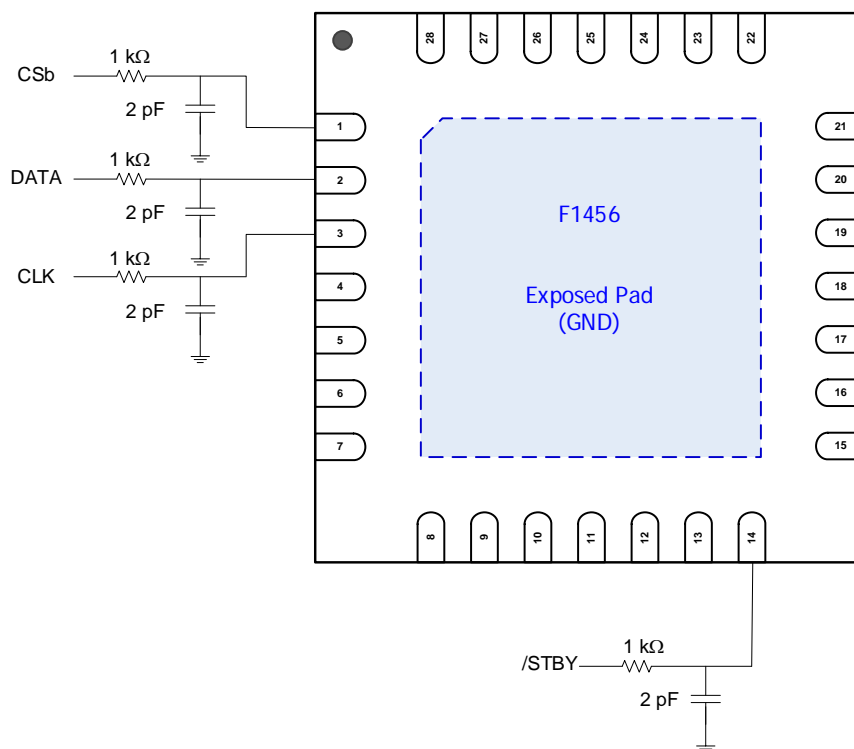

Figure 64. Control Pin Interface for Signal Integrity

7. Evaluation Kit

7.1 Evaluation Kit Pictures

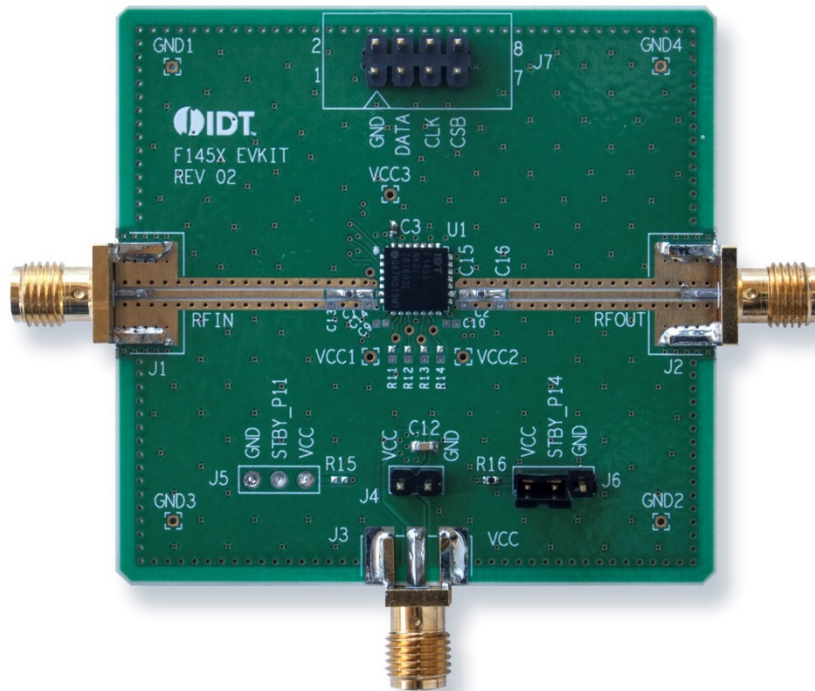

Figure 65. Top View

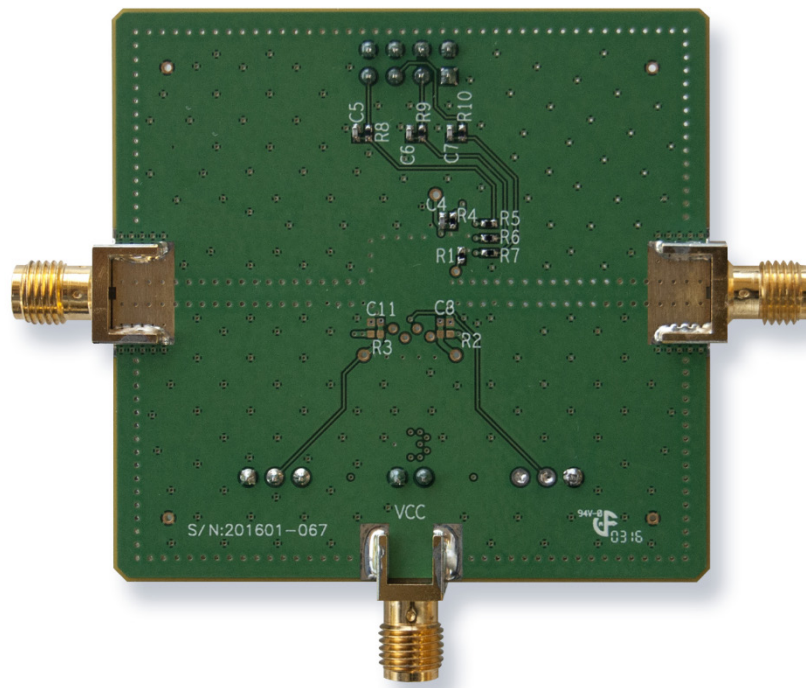
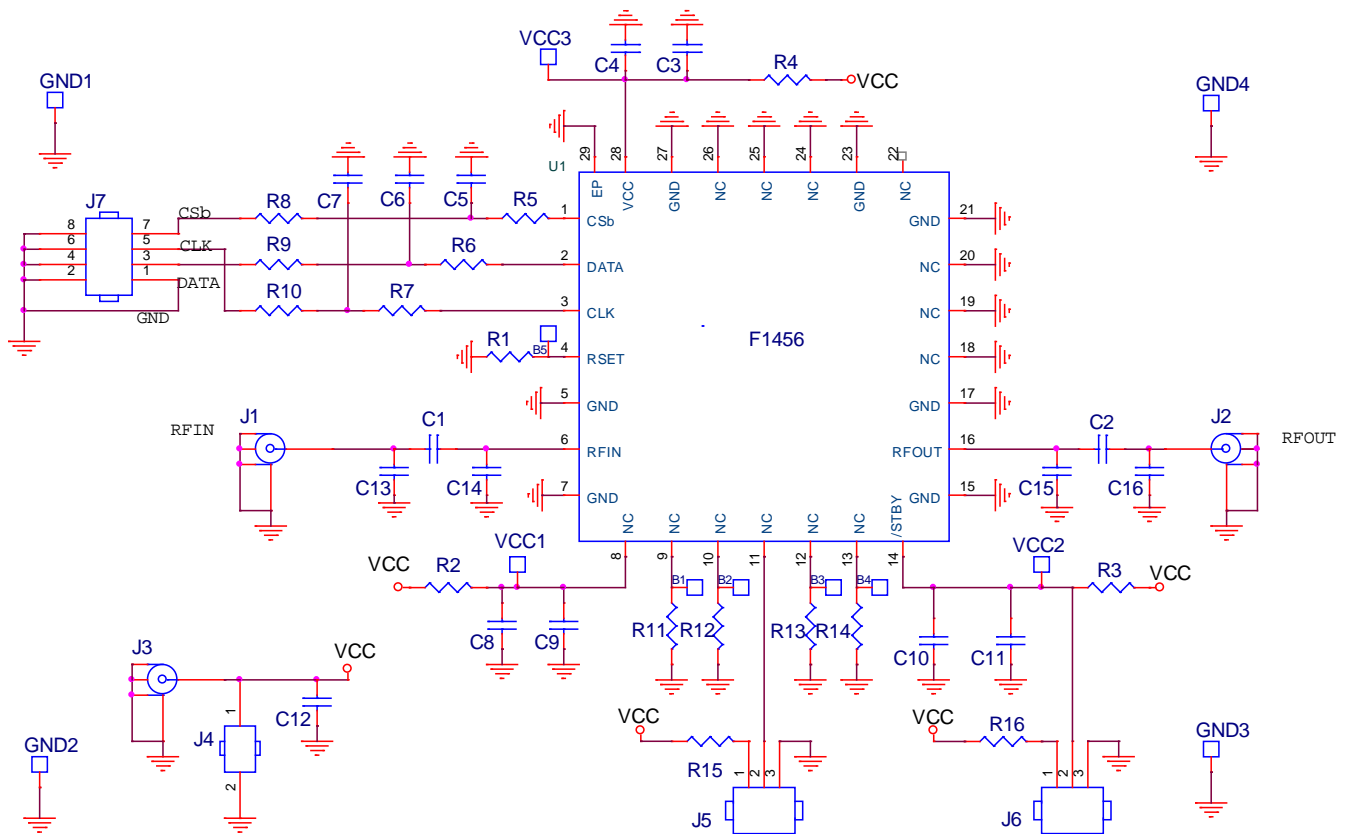

Figure 66. Bottom View

7.2 Evaluation Kit Schematic Circuit



Not All Components are used. Please check the Bill of Material (BOM) table.

Figure 67. Evaluation Kit Schematic Diagram

Table 10. Bill of Material (BOM)

Part Reference	Qty	Description	Manufacturer Part #	Manufacturer
C1, C2	2	22pF \pm 5%, 50V, C0G Ceramic Capacitor (0402)	GRM1555C1H220J	MURATA
C3	1	100nF \pm 10%, 16V, X7R Ceramic Capacitor (0402)	GRM155R71C104K	MURATA
C4	1	1000pF \pm 5%, 50V, C0G Ceramic Capacitor (0402)	GRM1555C1H102J	MURATA
C5, C6, C7	3	2pF \pm 0.1pF, 50V, C0G Ceramic Capacitor (0402)	GRM1555C1H2R0B	MURATA
C12	1	10uF \pm 20%, 16V, X6S Ceramic Capacitor (0603)	GRM188C81C106M	MURATA
R1	1	2.2k Ω \pm 1%, 1/10W, Resistor (0402)	ERJ-2RKF2201X	PANASONIC
R4 - R7	4	0 Ω Resistor (0402)	ERJ-2GE0R00X	PANASONIC
R8 - R10, R16	4	1k Ω \pm 1%, 1/10W, Resistor (0402)	ERJ-2RKF1001X	PANASONIC
J4	1	CONN HEADER VERT SGL 2 X 1 POS GOLD	961102-6404-AR	3M
J6	1	CONN HEADER VERT SGL 3 X 1 POS GOLD	961103-6404-AR	3M
J7	1	CONN HEADER VERT DBL 4 X 2 POS GOLD	67997-108HLF	FCI
J1, J2	2	Edge Launch SMA (0.375 inch pitch ground, tab)	142-0701-851	Emerson Johnson
J3	1	Edge Launch SMA (0.250 inch pitch ground, round)	142-0711-821	Emerson Johnson
U1	1	VGA AMP	F1456NKGK	Renesas
C8 - C11, C13 - C16, R2, R3, R11 - R15, J5		DNP		
	1	Printed Circuit Board	F145X EVKIT REV 02	

7.3 Evaluation Kit Operation

7.3.1. Standby

Connector J6 allows the F1456 to be put into the standby mode. Connecting J6 pin 2 (the center pin) to V_{cc} the amplifier will be placed in normal operating mode. To put the F1456 into standby mode for very low power consumption ground J6 pin 2 (the center pin). If J6 pin 2 (the center pin) is left open, then the F1456 will default to the standby mode.

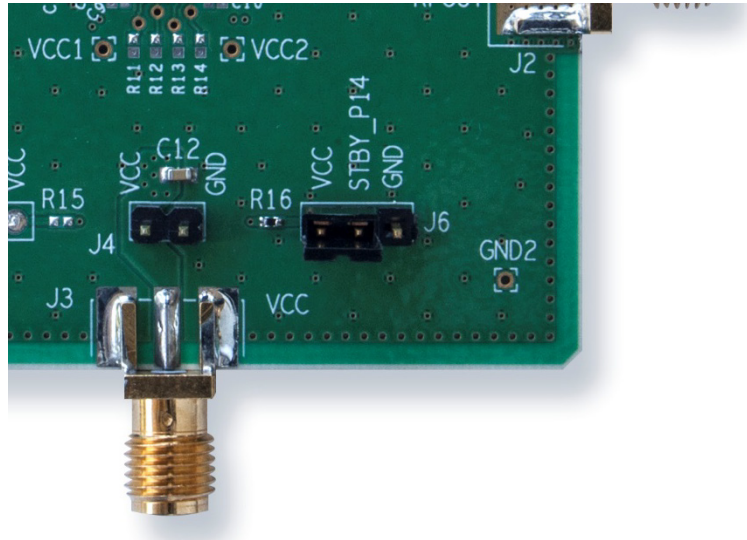

Figure 68. J6 Connector for Standby Mode Control

7.3.2. Serial Programming Pins

Connector J7 pins 1, 2, 4, 6, 8 are ground. Pin 3 is DATA, pin 5 is Clock (CLK), pin 7 is Chip Select (CSB).

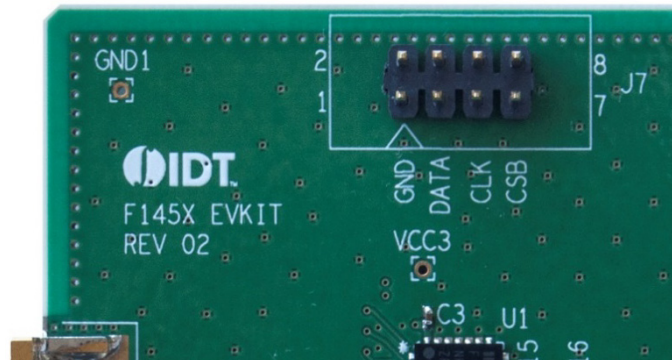

Figure 69. J7 Connector for SPI

8. Package Outline Drawings

The package outline drawings are located at the end of this document and are accessible from the Renesas website. The package information is the most current data available and is subject to change without revision of this document.

9. Ordering Information

Part Number	Package	MSL Rating	Carrier Type	Temp. Range
F1456NKGK	6 x 6 x 0.9 mm 28-VFQFPN	1	Tray	-40° to +105°C
F1456NKGK8	6 x 6 x 0.9 mm 28-VFQFPN	1	Tape and Reel	-40° to +105°C
F1456EVBK	Evaluation Board			
F1456EVSK	Evaluation Solution			

10. Marking Diagram

IDT F1456 NKGK ZW1629L ● Q54E042PY
--

- Line 2 and 3 are the part number.
- Line 4 "ZW" is Assembly Stepping.
- Line 4 "yyww = 1629 has two digits for the year and week that the part was assembled.
- Line 4 "L" denotes Assembly Site.
- Line 5 "Q54E042PY" is the Assembly Lot number

11. Revision History

Revision	Date	Description
1.02	Feb 16, 2022	<ul style="list-style-type: none"> ▪ Updated the operating range down to 1500MHz ▪ Added plots for 1800MHz performance ▪ Completed other minor changes
1.01	Feb 9, 2022	Rebranded as Renesas.
1.00	Nov 9, 2016	Initial release.

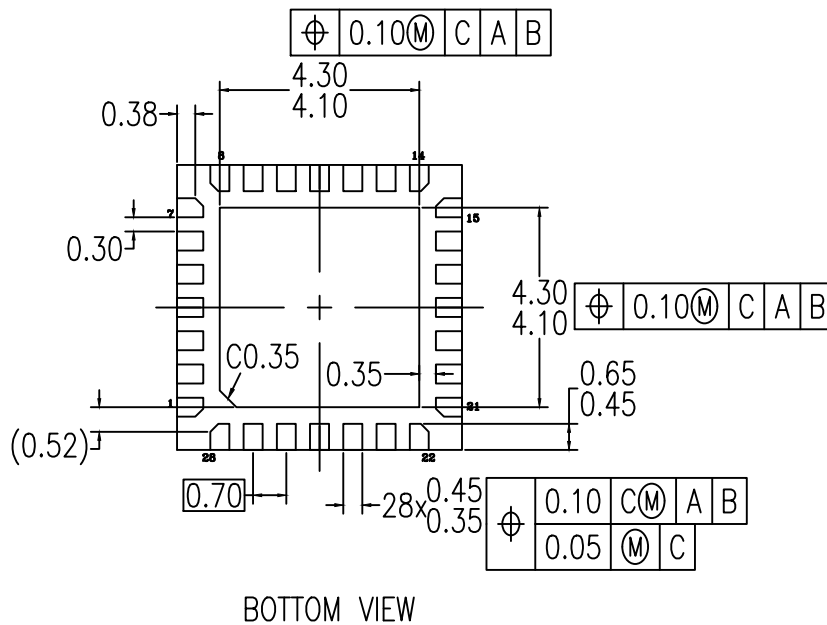
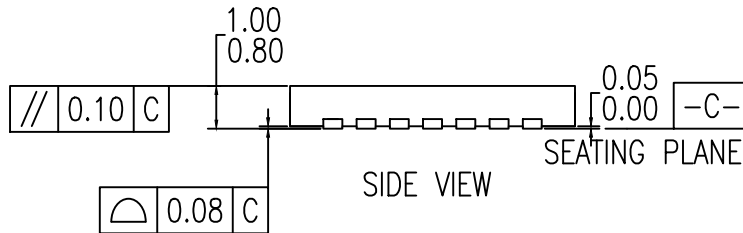
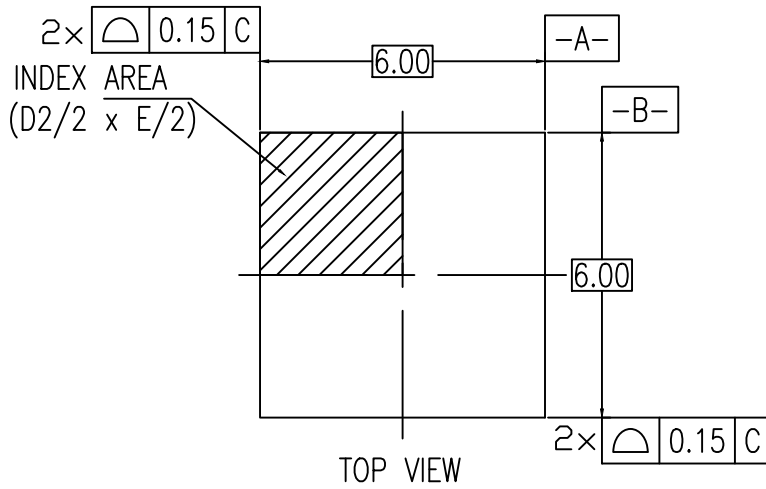

NOTES:

1. ALL DIMENSIONING AND TOLERANCING CONFORM TO ANSI Y14.5M-1982
2. ALL DIMENSIONS ARE IN MILLIMETERS.

IMPORTANT NOTICE AND DISCLAIMER

RENESAS ELECTRONICS CORPORATION AND ITS SUBSIDIARIES (“RENESAS”) PROVIDES TECHNICAL SPECIFICATIONS AND RELIABILITY DATA (INCLUDING DATASHEETS), DESIGN RESOURCES (INCLUDING REFERENCE DESIGNS), APPLICATION OR OTHER DESIGN ADVICE, WEB TOOLS, SAFETY INFORMATION, AND OTHER RESOURCES “AS IS” AND WITH ALL FAULTS, AND DISCLAIMS ALL WARRANTIES, EXPRESS OR IMPLIED, INCLUDING, WITHOUT LIMITATION, ANY IMPLIED WARRANTIES OF MERCHANTABILITY, FITNESS FOR A PARTICULAR PURPOSE, OR NON-INFRINGEMENT OF THIRD PARTY INTELLECTUAL PROPERTY RIGHTS.

These resources are intended for developers skilled in the art designing with Renesas products. You are solely responsible for (1) selecting the appropriate products for your application, (2) designing, validating, and testing your application, and (3) ensuring your application meets applicable standards, and any other safety, security, or other requirements. These resources are subject to change without notice. Renesas grants you permission to use these resources only for development of an application that uses Renesas products. Other reproduction or use of these resources is strictly prohibited. No license is granted to any other Renesas intellectual property or to any third party intellectual property. Renesas disclaims responsibility for, and you will fully indemnify Renesas and its representatives against, any claims, damages, costs, losses, or liabilities arising out of your use of these resources. Renesas' products are provided only subject to Renesas' Terms and Conditions of Sale or other applicable terms agreed to in writing. No use of any Renesas resources expands or otherwise alters any applicable warranties or warranty disclaimers for these products.

(Rev.1.0 Mar 2020)

Corporate Headquarters

TOYOSU FORESIA, 3-2-24 Toyosu,
Koto-ku, Tokyo 135-0061, Japan
www.renesas.com

Contact Information

For further information on a product, technology, the most up-to-date version of a document, or your nearest sales office, please visit:
www.renesas.com/contact/

Trademarks

Renesas and the Renesas logo are trademarks of Renesas Electronics Corporation. All trademarks and registered trademarks are the property of their respective owners.