

# LTpowerCAD™ II v2.0 Design Tool User's Guide

*LTpowerCAD@analog.com*

**Ver. 2.5.7**  
**Jan 2019**

Note: The Linear Technology LTpowerCAD™ II Design Tool is a powerful power supply design program for selected Linear Technology products. This document serves as a guide for the Linear Technology LTpowerCAD™ II Design Tool. It explains the various functions that are supported by the LTpowerCAD™ II Design Tool.



# TABLE OF CONTENTS

<b>1. Installation :</b>		
1. <u>Linear Technology Corporation LTpowerCAD™ II Design Tool License Agreement</u>	<u>3</u>	
2. <u>Installation Requirements</u>		<u>4</u>
3. <u>Installing LTpowerCAD™ II</u>		<u>7</u>
<b>2. Program Windows :</b>		
1. <u>Start Window &amp; Features</u>		<u>10</u>
2. <u>Part Search Window &amp; Features</u>	<u>14</u>	
3. <u>Design Window &amp; Features</u>		<u>21</u>
i. <u>Power Stage Design Tab &amp; Features</u>	<u>23</u>	
ii. <u>Loss Estimate and Break Down Tab &amp; Features</u>	<u>34</u>	
iii. <u>Loop Compensation and Load Transient Tab &amp; Features</u>	<u>42</u>	
<b>3. Appendix :</b>		
1. <u>Linear Technology Corporation LTpowerCAD™ II Design Tool License Agreement</u>	<u>54</u>	
2. <u>Load Transient Prediction</u>		<u>57</u>
3. <u>The Accuracy of LTpowerCAD™ II Design Tool</u>	<u>57</u>	
4. <u>LTpowerCAD™ II Design Tool Supported LTC Products List</u>	<u>58</u>	
5. <u>LTpowerCAD™ II Design Tool Contact Information</u>		<u>58</u>
6. <u>LTpowerCAD™ II Design Tool Release Information</u>		<u>58</u>

## 1.1 LINEAR TECHNOLOGY CORPORATION LTPowerCAD™ II DESIGN TOOL LICENSE AGREEMENT/DISCLAIMER

Welcome to the Linear Technology LTPowerCAD™ II Design Tool. The LTPowerCAD™ II Design Tool is a powerful power supply design tool program that significantly eases the tasks of selecting component values, estimating power loss and efficiency, and optimizing the compensation loop.

This design tool is copyrighted. In accordance with the terms and conditions of the [LTPowerCAD™ Design Tool License Agreement](#) in the Appendix, upon acceptance of the agreement, you will be granted a non-exclusive, non-transferable, royalty-free right solely to design supplies with Linear Technology products. Linear Technology Corporation owns the LTPowerCAD™ II Design Tool. You may not redistribute, adapt, translate, reverse engineer, decompile, or disassemble the LTPowerCAD™ II Design Tool. Upgrades, modifications, or repairs to this design tool will be strictly at the discretion of Linear Technology.

As always, Linear Technology has made the best effort to support our customers. However, due to the external component value variations, it remains the customer's responsibility to verify the program's calculation results by actually building the circuit and evaluating its performance.

**Note:**

Please note that the current version of the LTPowerCAD™ II Design Tool only supports a limited number of Linear Technology Monolithic and uModule Parts. For a full list of Linear Technology products and selection guideline, please visit [www.linear.com](http://www.linear.com) or contact your local sales representative.

## 1.2 INSTALLATION REQUIREMENTS

### Microsoft .NET Framework

- LTpowerCAD II v2.0 uses components from Microsoft's .NET framework. Microsoft .NET Framework 3.5 SP1 *or higher* is required to be installed on the system. This requirement, if not met, is automatically installed by the installer during the installation process.

### Microsoft SQL Server Compact

- LTpowerCAD II v2.0 also uses Microsoft's SQL Server Compact. Microsoft SQL Server Compact 3.5 SP2 is required to be installed on the system. This requirement, if not met, is automatically installed by the installer during the installation process.

## Where do I get these?

The LTpowerCAD II v2.0 installer automatically detects if your system has these requirements installed during the installation process. If the system does not meet the requirements the installer will ask and automatically download and install these requirements. If for some reason your system has not installed these requirements which may be causing errors running the program, these requirements are also available from the links below.

[Microsoft .NET Framework 3.5 SP1](http://www.microsoft.com/en-us/download/details.aspx?id=22) (<http://www.microsoft.com/en-us/download/details.aspx?id=22>)

[Microsoft SQL Server Compact 3.5 SP2](http://www.microsoft.com/en-us/download/details.aspx?id=5783) (<http://www.microsoft.com/en-us/download/details.aspx?id=5783>)

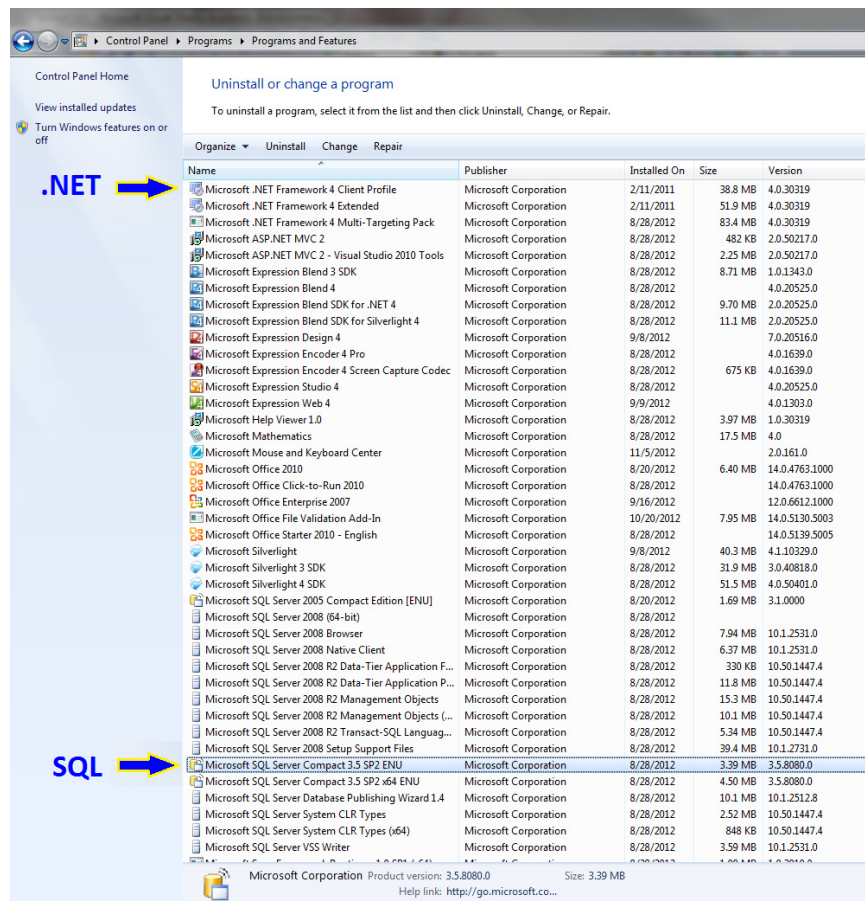

## Installation Folder Permissions

- LTpowerCAD II v2.0 requires proper configuration of permissions of its installation folder for proper operation. Folder permissions are automatically configured by the installer during the installation process.

### Where do I check this?

The LTpowerCAD II v2.0 installer automatically configures permission settings of the installation folder during the installation process. To check the permissions of your installation folder for Windows, go to your installation folder location and right click to select *Properties*. On the *Security* tab select the *Users* account to see the folder permissions. The folder permissions for the user should be set automatically set to Allow *Full Control*. If for some reason these folder permissions are not set to Full Control, please set these permissions manually as shown below.

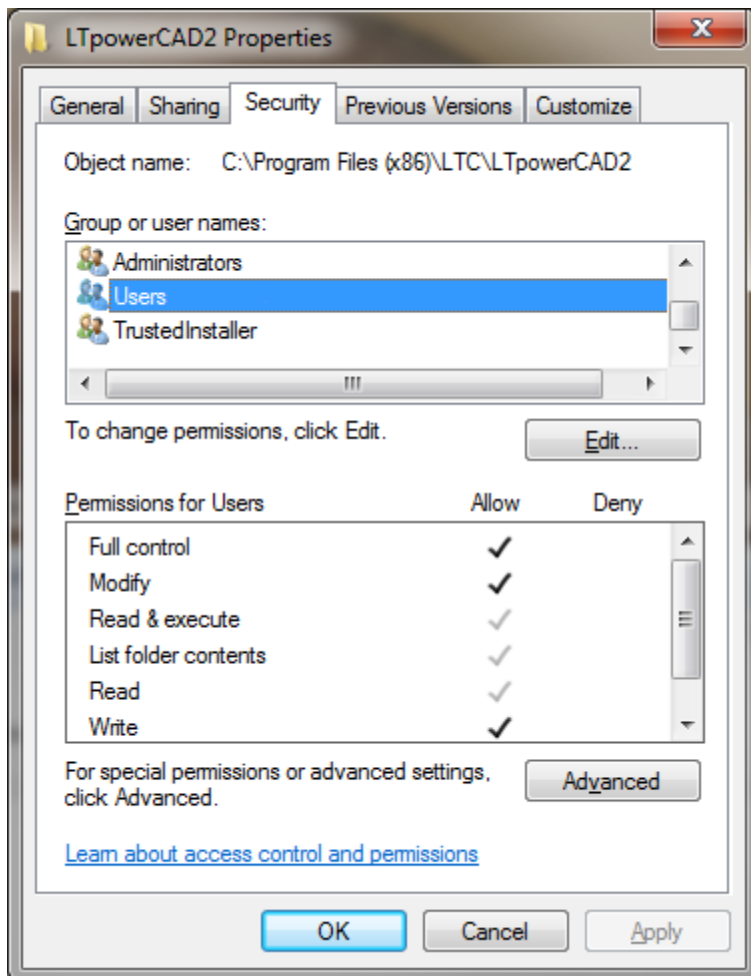

## 1.3 INSTALLING LTPOWERCAD II

### Getting the LTpowerCAD II v2.0 Installer

LTpowerCAD II v2.0 is installed with the LTpowerCAD II v2.0 Installer. The install package can be downloaded directly from the Linear Technology Website Design Tools Page <http://www.linear.com/designtools/software/>

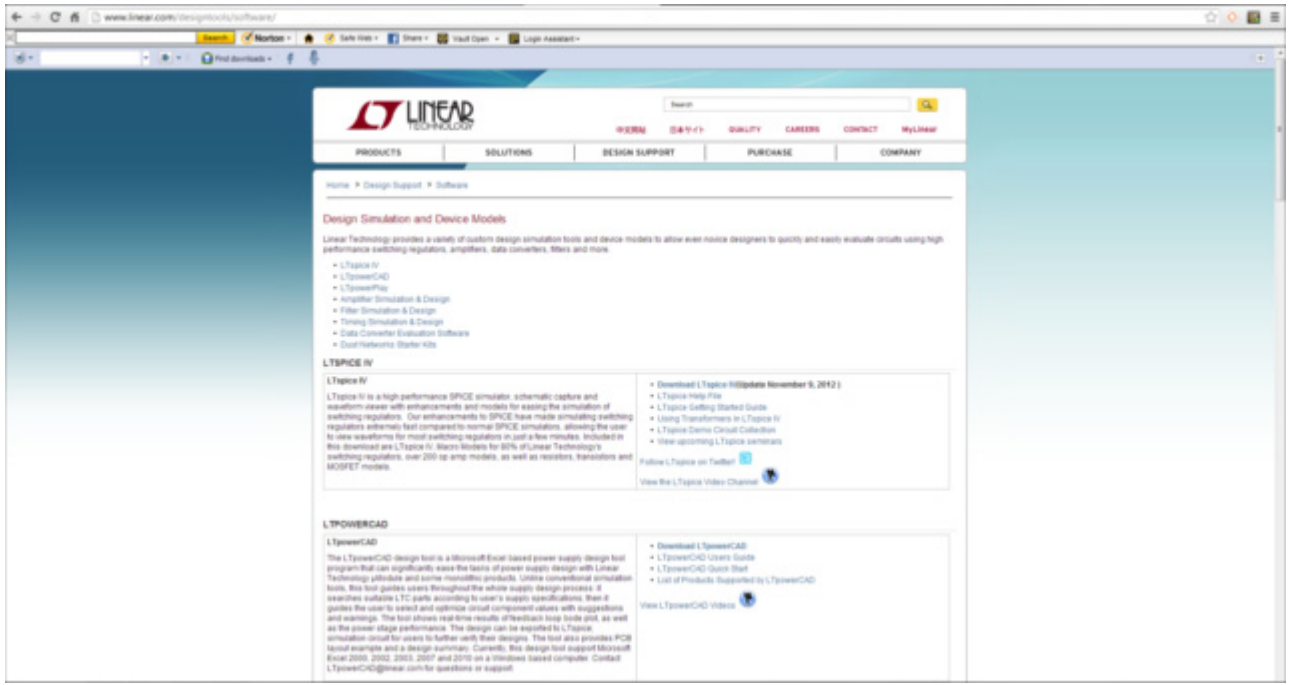

To install LTpowerCAD II v2.0, double click the "setup.exe" file to open the Installer Application for the program located in the install package.

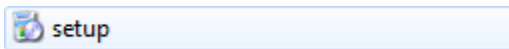

Do not install by instead double clicking the "MS.msi" in the installer package as this will prevent the installer from installing any missing required Microsoft program requirements.

### Installation Steps

To Install LTpowerCAD v2.0 follow the steps in the installer. For a typical installation no information is needed by the user, just click the Next button in the installer windows until the final window in the installer is reached, then click Close to complete.



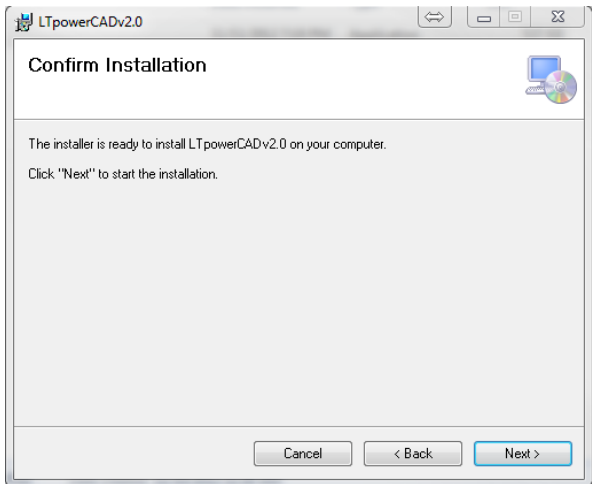
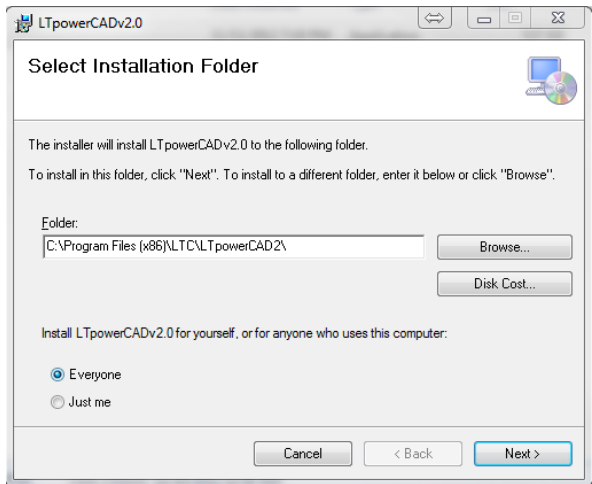
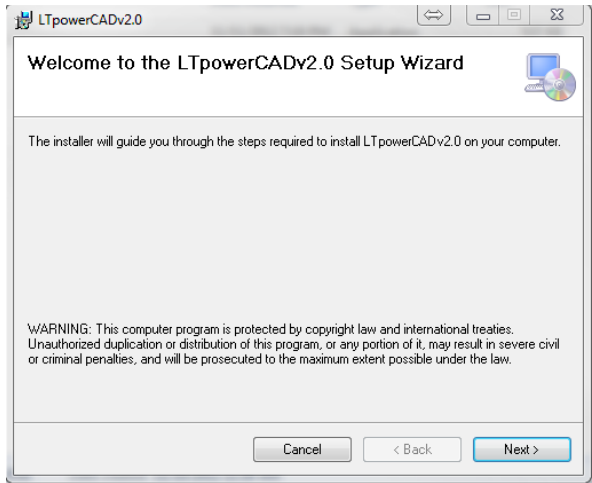

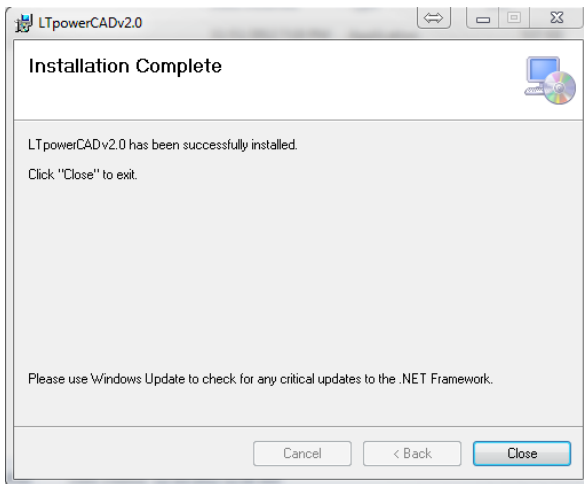
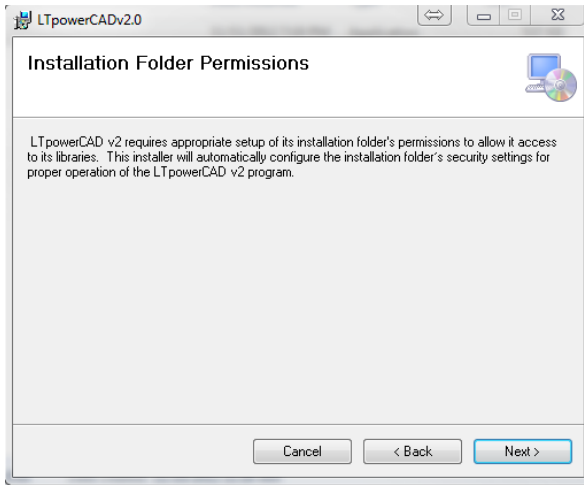

## LTpowerCAD v2.0 Shortcuts

After the installation has completed, LTpowerCAD v2.0 places a shortcut to the program on your desktop as well as a shortcut in your Windows Start Menu LTpowerCAD v2.0 program folder. Double click any of these shortcuts to open the program and get started with your LTpowerCAD v2.0 design.

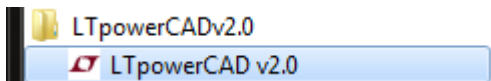
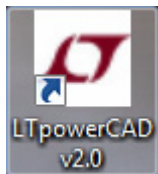

## 2.1 START WINDOW & FEATURES

*The Start Window is the start-up window of the program. From the Start Window :*

- Start a new Design
- Open an Existing saved design
- View Help File
- View LTC Sales Contacts
- View LTC Toolbox
- Sync Release to get the latest design tools and version program

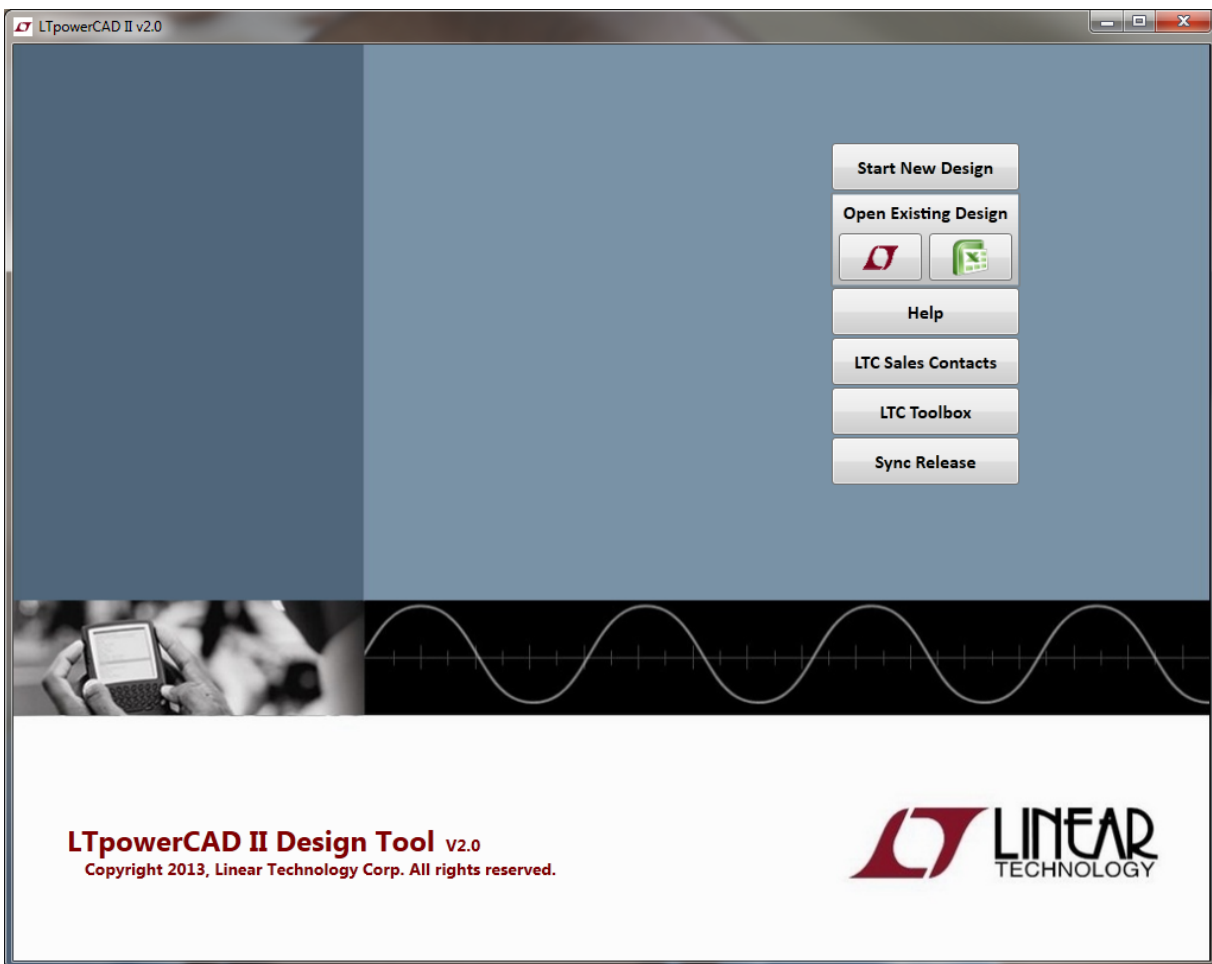

## Start New Design :

Hit the *Start New Design* button to begin a new power supply design. Clicking this button takes you to the Part Search Window where you can enter the operating conditions for your application to find suitable parts to start designing with.



Start New Design

## Open Existing Design :

Hit the *Open Existing Design* button to open a previously saved design tool file. To open an existing LTpowerCAD II v2.0 design tool click on the [LTC icon](#). To open an existing LTpowerCAD v1.x Microsoft Excel based design tool click on the [Excel icon](#).

### Open Existing Design



## Help :

Click the *Help* button to open the LTpowerCAD II help file.



Help

## LTC Sales Contacts :

Click the *LTC Sales Contacts* button to view contact for our Sales offices around the world. Phone, Fax and Sales office addresses are available. Your local sales office is a great resource to help you get in touch with your local Field Sales Engineer as well as your local Field Applications Engineer to help you with your power supply design needs.





LTC Sales Contacts

Linear Technology Corporation Sales Contacts				
North America	Asia	Europe	South America and Australia	
Northern / Western		Southern / Eastern		
<b>NORTHERN CALIFORNIA</b>	<b>PACIFIC NORTHWEST</b>	<b>TORONTO</b>	<b>COLUMBUS</b>	<b>MISSOURI</b>
<b>BAY AREA</b>	<b>DENVER</b>	2187 Grand Ravine Drive	2526 Brandon Road	2430 SE 5th Ter
720 Sycamore Dr	7007 Winchester Circle, Ste 130	Oakville, Ontario L6H 6B2 Canada	Columbus, OH 43221	Lees Summit, MO 64063
Milpitas, CA 95035	Boulder, CO 80301	Tel: (905) 582-7238	440-239-0817 Tel	816-678-7525 Tel
Tel: (408) 428-2050	Tel: (303) 926-0002			
<b>CENTRAL VALLEY</b>	<b>PORTLAND</b>	<b>WESTERN CANADA</b>	<b>DETROIT</b>	<b>ST. LOUIS</b>
2260 Douglas Blvd, Ste 280	5005 SW Meadows Rd, Ste 410	5842 Sefton Street	39111 West Six Mile Road, Suite 143	2617 Wynncrest Ridge Lane
Roseville, CA 95661	Lake Oswego, OR 97035	Port Coquitlam, B.C. V3B 3R9 Canada	Livonia, MI 48152	Wildwood, MO 63005
Tel: (916) 787-5210	Tel: (503) 520-9930	Tel: (604) 729-1204	734-779-1657 Tel	314-256-8908 Tel
<b>SOUTHWEST</b>	<b>SALT LAKE CITY</b>	2860 Lionel Cres SW	<b>INDIANA</b>	<b>WISCONSIN</b>
<b>LOS ANGELES</b>	3826 South 4200 West	Calgary, Alberta T2E 6R2 Canada	12229 Heatherstone Place	6131 111th Street
21243 Ventura Blvd, Ste 238	West Haven, UT 84401	Tel: (403) 455-3577	Carmel, IN 46033	Pleasant Prairie, WI 53158
Woodland Hills, CA 91364	Tel: (801) 731-8008	24521 Kimola Drive	317-443-1169 Tel	262-697-5001 Tel
Tel: (818) 703-0835	<b>SEATTLE</b>	Maple Ridge, B.C. V2W 0B9 Canada	<b>IOWA</b>	
<b>ORANGE COUNTY</b>	2018 156th Avenue NE, Suite 100	Tel: (604) 783-3084	2040 E. Algonquin Road, Suite 512	
7595 Irvine Center Drive Ste, 120	Bellevue, WA 98007	6087 163A Street	Schaumburg, IL 60173	
Irvine, CA 92618	Tel: (425) 748-5010	Surrey BC V3S 2H7 Canada	847-925-0860 Tel	
Tel: (949) 453-4650	<b>EASTERN CANADA</b>	Tel: (778) 378-0798	<b>KANSAS</b>	
<b>PHOENIX</b>	<b>MONTREAL</b>	<b>CENTRAL</b>	14408 S. Alden Court	
2085 East Technology Circle Ste, 101	591 Lajeunesse	<b>CHICAGO</b>	Olathe, KS 66062	
Tempe, AZ 85284	Laval, Quebec H7X 3K4 Canada	2040 E. Algonquin Road, Suite 512	913-829-8844 Tel	
Tel: (480) 777-1600	Tel: (450) 889-2660	Schaumburg, IL 60173	<b>MINNEAPOLIS</b>	
<b>SAN DIEGO</b>	<b>OTTAWA</b>	Tel: (647) 925-0860	7805 Telegraph Road, Suite 225	
5090 Shoreham Place, Ste 106	21 de Jean-Les-Pins	<b>CLEVELAND</b>	Bloomington, MN 55438	
San Diego, CA 92122	Gatineau, Quebec J8T 6B7 Canada	7550 Lucerne Drive, Suite 106	952-903-0605 Tel	
Tel: (858) 638-7131	Tel: (819) 775-3140	Middleburg Heights, OH 44130		
		Tel: (440) 339-0817		

## LTC Toolbox :

Click the *LTC Toolbox* button to open the LTC Toolbox which contains generic tools to help with calculations for your design. Sync release function ensures you have the latest available tools and that they are all up to date.

**LTC Toolbox**

TOOLBOX - LTpowerCAD II v2.0	
Settings	Help
 <b>LTpowerCAD Design Toolbox</b> Copyright 2013, Linear Technology Corp. All rights reserved.	
Tool Name	Tool Description
 <b>Resistor Divider</b>	Excel tool to select standard resistor values with minimum matching error

## Sync Release :

Click the *Sync Release* button to update your LTpowerCAD II program with the latest design tools available as well as to get the latest version of the LTpowerCAD II v2.0 program. Clicking the *Sync Release* button takes you to the program updater which downloads all the latest tools to your installed library and also makes sure you always have the latest version of the program.

**Sync Release**

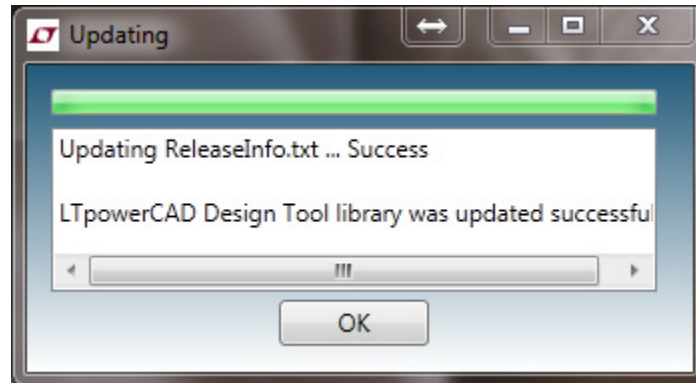

## 2.2 PART SEARCH WINDOW & FEATURES

**The Part Search Window helps you to find the right part for your supply requirements based on your operating conditions. Begin the design process with the part's available design tool. From the Part Search Window :**

- Enter input operating conditions, output rail requirements as well as select optional part features to find qualifying parts in the library
- Search for even more parts using the LTC parametric search on the web
- View basic specs. and features for parts
- Open part datasheets
- Open design tool(s) for the part to begin the design process

**LTpowerCAD II v2.0**  
**LINEAR TECHNOLOGY** **LTpowerCAD Design Tool v2.0**  
 Copyright 2013, Linear Technology Corp. All rights reserved.

**Converter Specification**

Converter Topology: Buck  
 Converter Type: All

Min. Input Voltage: 4.5 V  
 Nom. Input Voltage: 12 V  
 Max. Input Voltage: 24 V

Num. of Output Rails: Two

Output Rail 1: Vout1 = 1.2 V, Iout1 = 10 A  
 Output Rail 2: Vout2 = 1.8 V, Iout2 = 8 A

Find Part #: (####) [ ] [Go]

**Optional Features**

- Burst Mode
- Synchronous FET
- Isolated
- Run / Enable
- Sync. to External Clock
- Output Voltage Tracking
- Remote Voltage Sensing
- Margin Control
- Power Good Monitor
- Poly-phase / Load Share
- I2C/PMBus Interface

**Search**

[Search]  
 [LTC Web Search]  
 [All Parts]

Always Keep Search Page Open

Design Tool	Website	Part Name	Type	Desc.	Topology	Max Vin	Min Vin	Max Iout/
[Icon]	LTC Web	LTC3880	Controller	Dual Vo Current Mode PolyPhase Step-Down DC/DC Controller with PMBus	Buck	24	4.5	30
[Icon]	LTC Web	LTC3860	Controller	Dual Voltage Mode Buck Controller with Current Sharing (use LTC3861 for new designs)	Buck	24	3	30
[Icon]	LTC Web	LTC3861	Controller	Dual Voltage Mode buck Controller with Accurate Current Sharing (no Gate Driver)	Buck	24	3	30
[Icon]	LTC Web	LTC3850	Controller	Dual, 2-Phase Sync-Buck Controller. Peak current mode. Recommend LTC3869 or 3865.	Buck	24	4	30
[Icon]	LTC Web	LTC3828	Controller	Dual Vo Buck Regulator. Use LTC3850/3855/3865/3869 for new designs.	Buck	28	4.5	30
[Icon]	LTC Web	LTC3707	Controller	Dual Vo Buck Regulator. Use LTC3850/3855/3865/3869 for new designs.	Buck	28	4.5	30
[Icon]	LTC Web	LTC3728L	Controller	Dual Vo Buck Regulator. Use LTC3850/3855/3865/3869 for new designs.	Buck	28	4.5	30
[Icon]	LTC Web	LTC3838-2	Controller	Dual, Fast, Accurate Buck Controller with Remote Vo Sense and Ext Vref	Buck	38	4.5	30
[Icon]	LTC Web	LTC3865-1	Controller	Dual Synchronous buck Controller with Pin Selectable Outputs (1% Vo error)	Buck	38	4.5	30
[Icon]	LTC Web	LTC3865	Controller	Dual Synchronous buck Controller with Pin Selectable Outputs (1% Vo error)	Buck	38	4.5	30
[Icon]	LTC Web	LTC3838-1	Controller	Dual, Fast, Accurate Buck Controller with Dual Remote Vo Sense	Buck	38	4.5	30
[Icon]	LTC Web	LTC3838	Controller	Dual, Fast, Accurate Buck Controller with Remote Vo Sense, Valley 1-Mode	Buck	38	4.5	30
[Icon]	LTC Web	LTC3868-1	Controller	Low IQ, 24Vin 14Vo, 2-Phase Synchronous Step-Down Controller	Buck	24	4	20
[Icon]	LTC Web	LTC3868	Controller	Low IQ, 24Vin 14Vo, 2-Phase Synchronous Step-Down Controller	Buck	24	4	20

LTpowerCAD currently supports design tools for a limited number of parts. For more part options click the LTC Web Search button.

## Enter Supply Basic Requirements :

Enter the basic power supply requirements for the application in the top half of the Part Search Window.

### Converter Specification :

Supply input and output basic specifications are entered in this region.

**Converter Topology :** Select the required converter topology to filter the part search results (All, Buck, Boost, Buck-Boost,...)

**Converter Type :** Select the preferred converter type to filter the part search results (All, Monolithic, uModule Regulator, Controller,...)

**Min., Nom. Max. Input Voltages :** Enter the expected minimum, nominal and maximum input supply voltage for the converter

**Num. of Output Rails :** Select the number of output rails required (One, Two, Three,...)

**Output Rail :** Enter the desired output voltage and current required of each output rail

Converter Specification	
Converter Topology	All ▼
Converter Type	All ▼
Min. Input Voltage	5 V
Nom. Input Voltage	10 V
Max. Input Voltage	20 V
Num. of Output Rails	Two ▼

Output Rail 1	
Vout1	1.2 V
Iout1	8 A
Output Rail 2	
Vout2	1.5 V
Iout2	8 A



**Optional Features :**

Select from a set of some common optional features available for LTC parts

**Burst Mode** : High Efficiency Light Load Current Operation

**Synchronous FET** : Synchronous power stage mosfet

**Isolated** : Isolated topology

**Run/Enable** : Run or enable pin available

**Sync. to External Clock** : Ability to synchronize switching frequency to an external clock signal

**Output Voltage Tracking** : Ability for output voltage to track an external reference signal

**Remote Voltage Sensing** : Ability to optionally remotely sense the output voltage for accurate output voltage regulation at the point of load

**Margin Control** : Ability to margin output voltage based on margin pin configurations

**Power Good Monitor** : Power Good pin to signal if output voltage is outside of regulation window

**Poly-phase / Load Share** : Ability to parallel output rails to share load current among paralleled phases to scale up current capability

**I2C / PMBus Interface** : I2C / PMBus compatible for power system communications & configuration

Optional Features

- Burst Mode
- Synchronous FET
- Isolated
- Run / Enable
- Sync. to External Clock
- Output Voltage Tracking
- Remote Voltage Sensing
- Margin Control
- Power Good Monitor
- Poly-phase / Load Share
- I2C/PMBus Interface

## Search for parts:

Search for parts within the LTpowerCAD II program library or if a part is not in the library, check the LTC Parametric search tables on the web to find the best part to fit your needs.

## Search Tools :

### Search Button:

Search the LTpowerCAD II program library for a list of parts that qualify for your application requirements. The search results are shown in the table in the lower half of the Part Search Window. If you know a specific part you are looking a design tool for, after entering your Converter Specifications, you can look for that part directly by entering the part number in the *Find Part Num.* search box.



Find Part Num. (####)

### All Parts :

View a list of all parts within the current LTpowerCAD II program library installed on your system

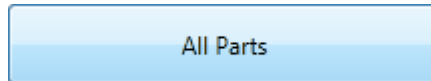

### LTC Web Search :

The LTpowerCAD II program library is constantly growing, so not all parts available from LTC may be included. However, you can do an extensive search using the parametric tables on Linear Technology's website to search through all parts available from Linear Technology to see what other parts may fit your needs by clicking the LTC Web Search Button. The LTpowerCAD II program will use your entered converter specification values for the search.

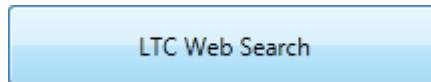

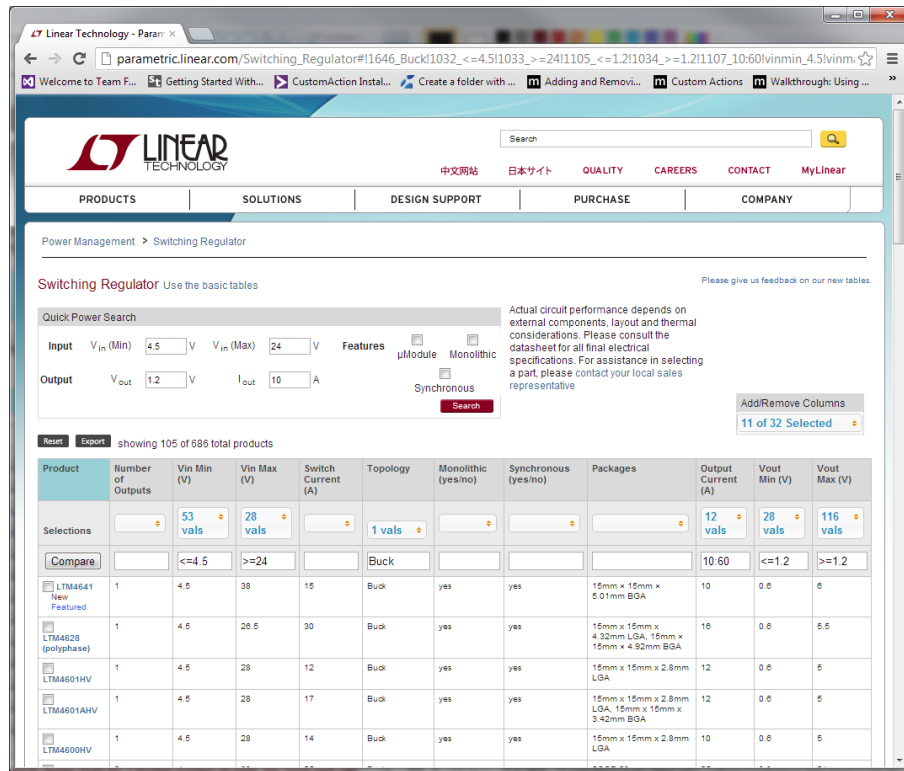





























### Always Keep Search Page Open :

The check box option allows for the search window to remain open (not automatically closed) after a part is selected from the search table to open its design tool.

Always Keep Search Page Open

## LTpowerCAD Library Search Table :

Search results after clicking the *Search* button are displayed in the lower half of the *Part Search Window*. The search results show a list of parts in the LTpowerCAD library on your system that qualify to meet or exceed your entered power supply design requirements.

Design Tool	Website	Part Name	Type	Desc.	Topology	Max Vin	Min Vin	Max Iout/
 	LTC Web	LTC3880	Controller	Dual Vo Current Mode PolyPhase Step-Down DC/DC Controller with PMBus	Buck	24	4.5	30
 	LTC Web	LTC3860	Controller	Dual Voltage Mode Buck Controller with Current Sharing (use LTC3861 for new designs)	Buck	24	3	30
 	LTC Web	LTC3861	Controller	Dual Voltage Mode buck Controller with Accurate Current Sharing (no Gate Driver)	Buck	24	3	30
 	LTC Web	LTC3850	Controller	Dual, 2-Phase Sync-Buck Controller. Peak current mode. Recommend LTC3869 or 3865.	Buck	24	4	30
 	LTC Web	LTC3828	Controller	Dual Vo Buck Regulator. Use LTC3850/3855/3865/3869 for new designs.	Buck	28	4.5	30
 	LTC Web	LTC3707	Controller	Dual Vo Buck Regulator. Use LTC3850/3855/3865/3869 for new designs.	Buck	28	4.5	30
 	LTC Web	LTC3728L	Controller	Dual Vo Buck Regulator. Use LTC3850/3855/3865/3869 for new designs.	Buck	28	4.5	30
 	LTC Web	LTC3838-2	Controller	Dual, Fast, Accurate Buck Controller with Remote Vo Sense and Ext Vref	Buck	38	4.5	30
 	LTC Web	LTC3865-1	Controller	Dual Synchronous buck Controller with Pin Selectable Outputs (1% Vo error)	Buck	38	4.5	30
 	LTC Web	LTC3865	Controller	Dual Synchronous buck Controller with Pin Selectable Outputs (1% Vo error)	Buck	38	4.5	30
 	LTC Web	LTC3838-1	Controller	Dual, Fast, Accurate Buck Controller with Dual Remote Vo Sense	Buck	38	4.5	30
 	LTC Web	LTC3838	Controller	Dual, Fast, Accurate Buck Controller with Remote Vo Sense, Valley I-Mode	Buck	38	4.5	30
 	LTC Web	LTC3868-1	Controller	Low IQ, 24Vin 14Vo, 2-Phase Synchronous Step-Down Controller	Buck	24	4	20
 	LTC Web	LTC3868	Controller	Low IQ, 24Vin 14Vo, 2-Phase Synchronous Step-Down Controller	Buck	24	4	20

## Search Results :

The Search Results in the Search Table show a list of qualifying parts including some basic information about each of the qualifying parts. From the Search table results you can also click to open the datasheet of the part you may be interested to get additional information. For a chosen part with available design tool(s), begin your power supply design by selecting the design tool icon in the left column of the table to open the design tool for the part.

A brief Description of some of the Search Table column's are shown below.

### Design Tool :

For a given row / part, the column holds spaces for two buttons. The left button (LTC logo), if active, indicates that an LTpowerCAD v2.0 design tool is available for the part. The right button (MS Excel logo), if active, indicates that an LTpowerCAD v1.x Microsoft Excel based design tool button is available for the part. Click on either of these buttons to open the design tool for the part and start your power supply design.

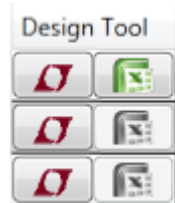

**Website :**

For a given row / part, the column holds an *LTC Web* button. Click the button to open the datasheet for the part to get detailed information about the part.

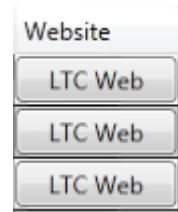
**Other Columns :**

The search results table also has many other columns to show some basic information for the part.

## 2.3 DESIGN WINDOW & FEATURES

The Design Window displays the design tool for the part. Within this window we can optimize the components in the supply design to create a power supply design that satisfies all of the details of your design requirements. Some key information to get you started is highlighted below. A detailed description of the Design Window and its features is given in the following sections.

### Tab Structure of the Design Window

The Design Window is arranged into tabs (shown below). Each of the tabs covers different aspects of the supply design. Each Tab is described in more detail in the following sections.

### Cells Within the Design Window

Within each of the tabs are **blue** cells which allow you to enter your chosen operating conditions and component values. There are also **yellow** cells which show key part information, suggested component values and calculated parameters to help guide you through finalizing the system components. The yellow cells if highlighted in **red** indicate warnings for the supply design, i.e. a parameter of the design is outside of the operating limits of the part, or the calculated parameter does not meet your requirements. Blue cell entries may need to be adjusted to get rid of any warnings so the component design meets your design requirements within the part's operating limits.

### Other Controls Within the Design Window

The Design Window is also arranged with a few other controls, such as selection buttons, drop down lists and sliders for adjusting various parameters of the design. More detail of these additional controls is available in the following sections.

## Power Stage Design Tab :

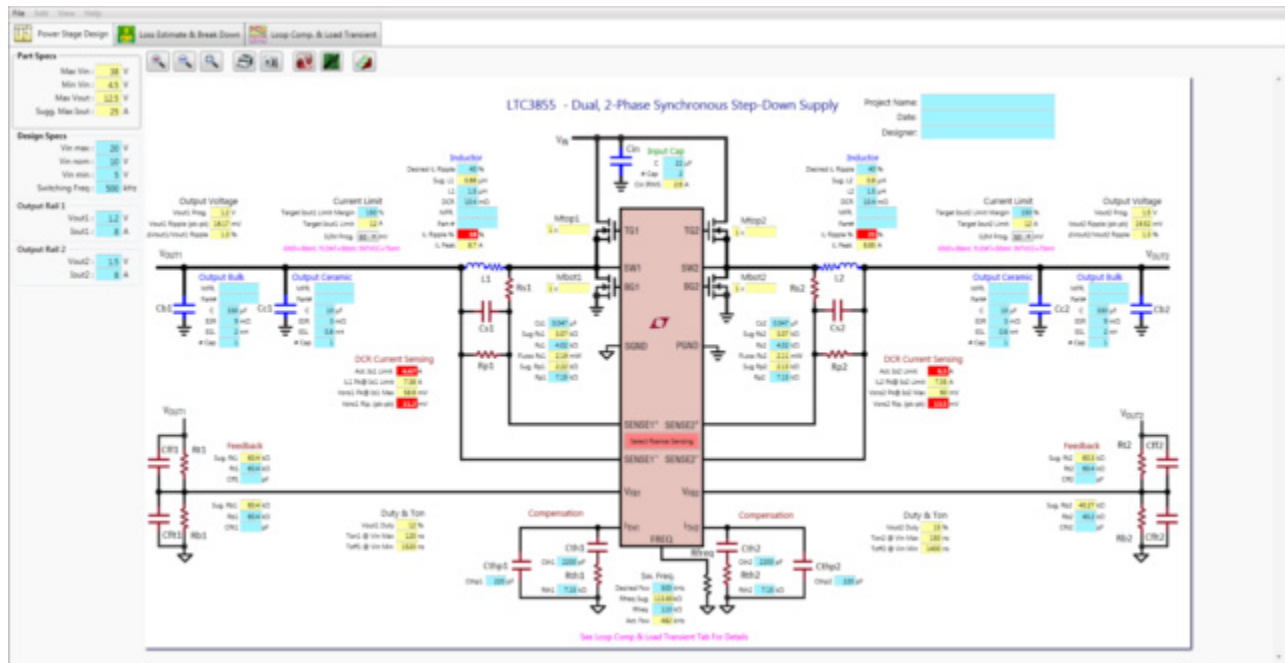

## Loss Estimate & Break Down Tab :

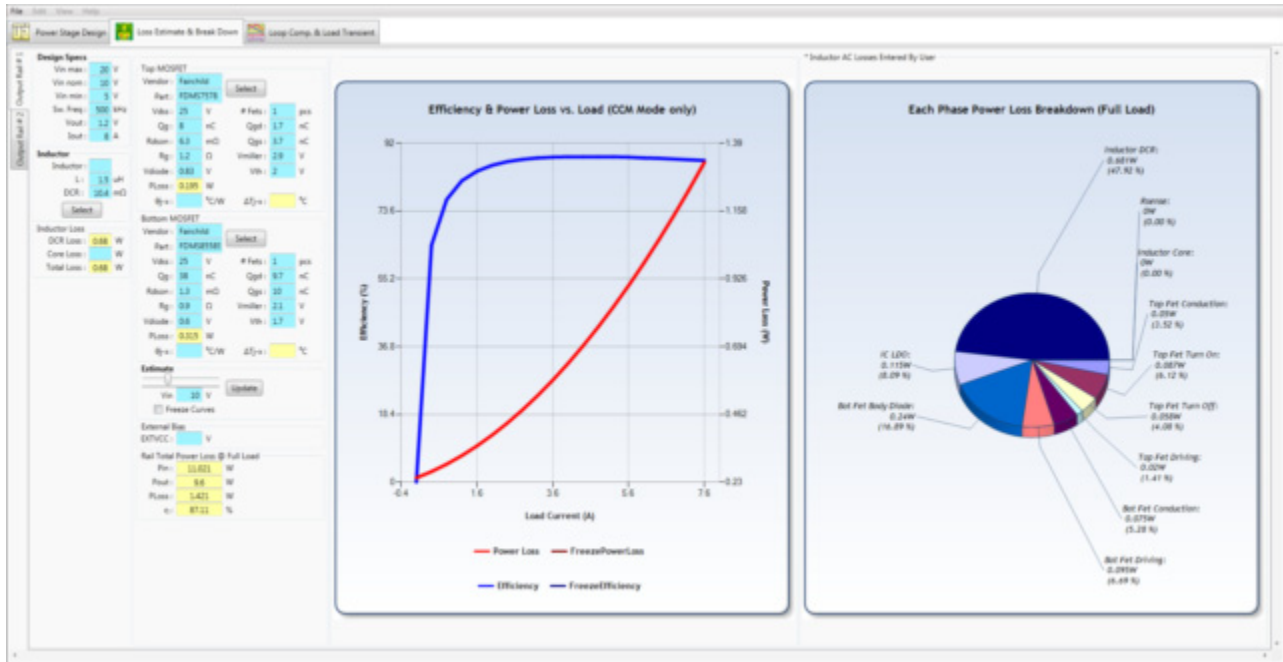

## Loop Comp. & Load Transient Tab :

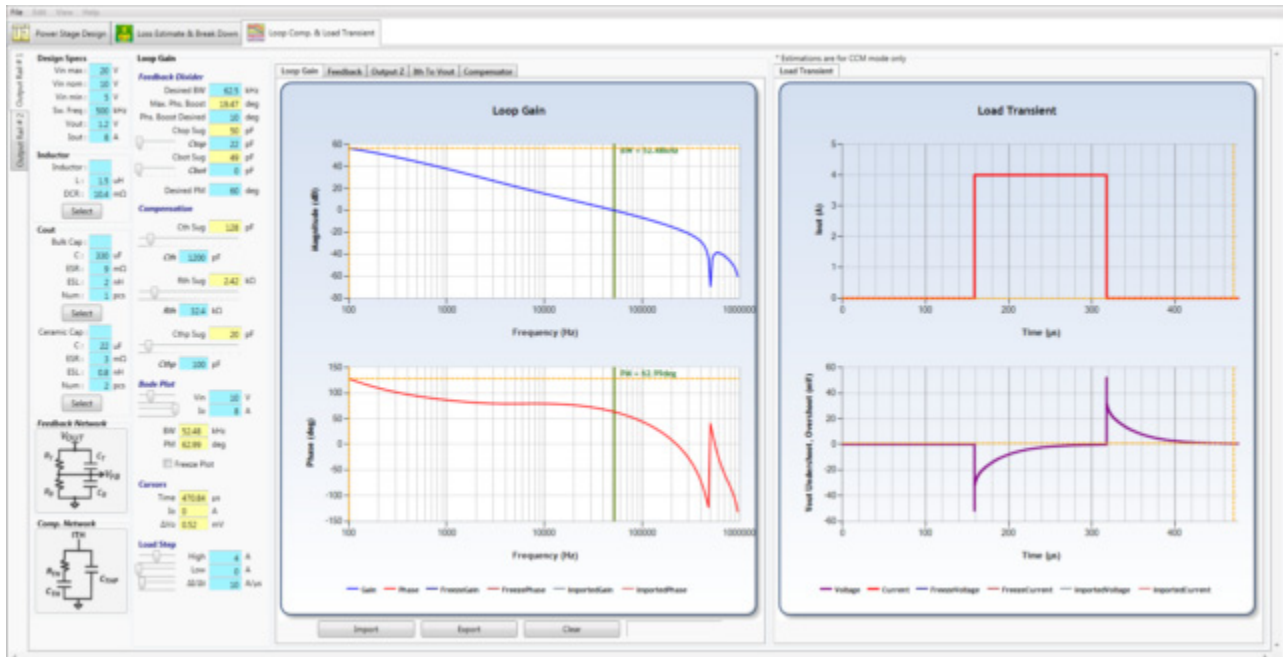

## 1. POWER STAGE DESIGN TAB

*The Power Stage Design Tab offers a user friendly schematic interface for your power supply design. It details important steady state aspects of your design such as output capacitor design for output voltage ripple requirements, inductor design for inductor current ripple design, current sensing network for current limit design. It also details all critical component values including feedback network, power stage mosfet choice, and compensation network components used in the design in a quick to review and easy to read schematic format. Other features of the Power Stage Design Tab include :*

- *A printable, image capturable, zoomable interactive schematic with various controls to help you select configurations, suggest component values and guide your design with value warnings and information*
- *A side bar listing a summary of the basic operating conditions for your application such as input voltages, switching frequency and input and output voltages for each of the output rails of your design*
- *Option to view design steps / design wizard*
- *Option to view an example layout image for your supply*
- *Option to export your project to LTSpice for time based simulations to see other performance aspects of your design*

*A more detailed description of some of these features available on the Power Stage Design Tab are shown below:*



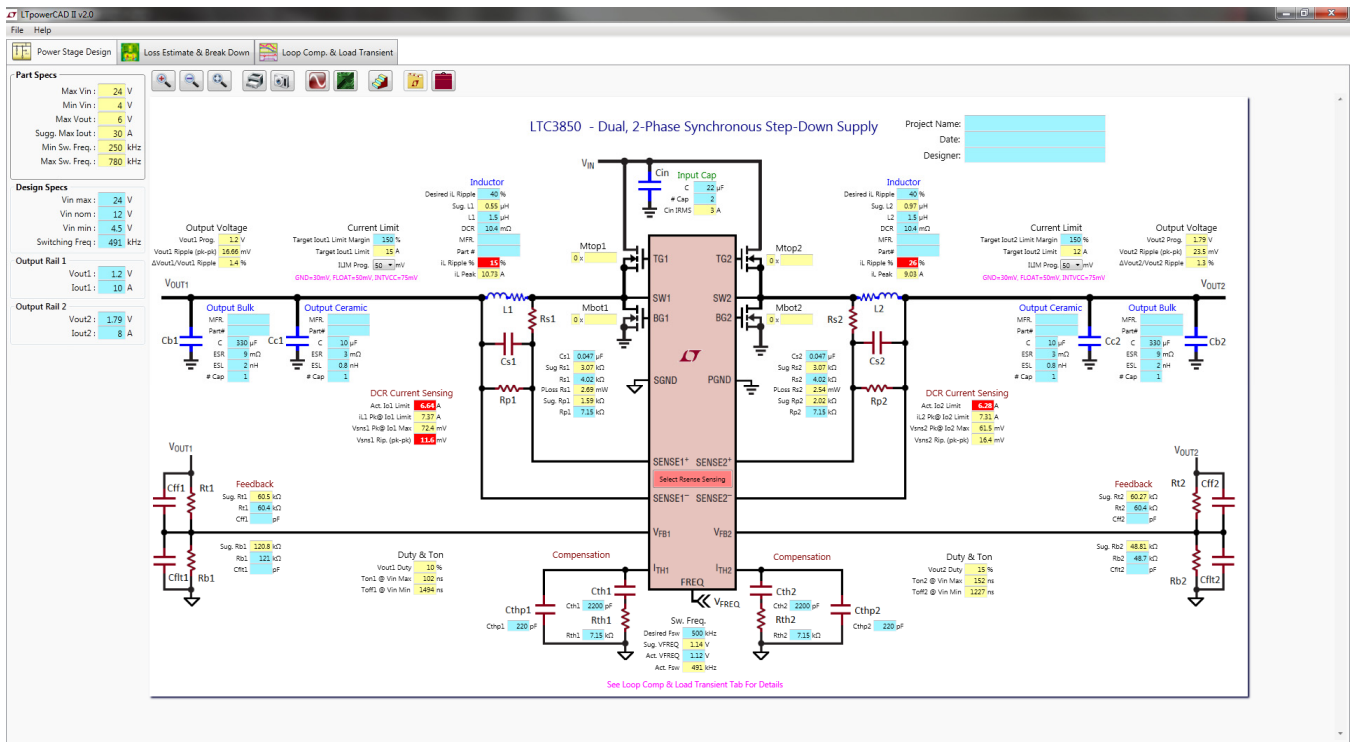

## Operating Conditions Summary :

A summary section is located on the left of the Power Stage Design Tab listing a basic summary of the operating conditions for the application as well as information for the basic suggested maximum ratings for the part used in the design.

**Part Specs**

Max Vin :	38 V
Min Vin :	4.5 V
Max Vout :	12.5 V
Sugg. Max Iout :	25 A

**Design Specs**

Vin max :	20 V
Vin nom :	10 V
Vin min :	5 V
Switching Freq :	500 kHz

**Output Rail 1**

Vout1 :	1.2 V
Iout1 :	8 A

**Output Rail 2**

Vout2 :	1.5 V
Iout2 :	8 A

## Interactive Schematic Interface :

Schematic of your supply including critical components for the design, and tools to help you optimize these critical component values. The schematic includes information for the different important groups of components in the schematic. Suggested values, calculated parameters and warnings help you with proper component value choices.

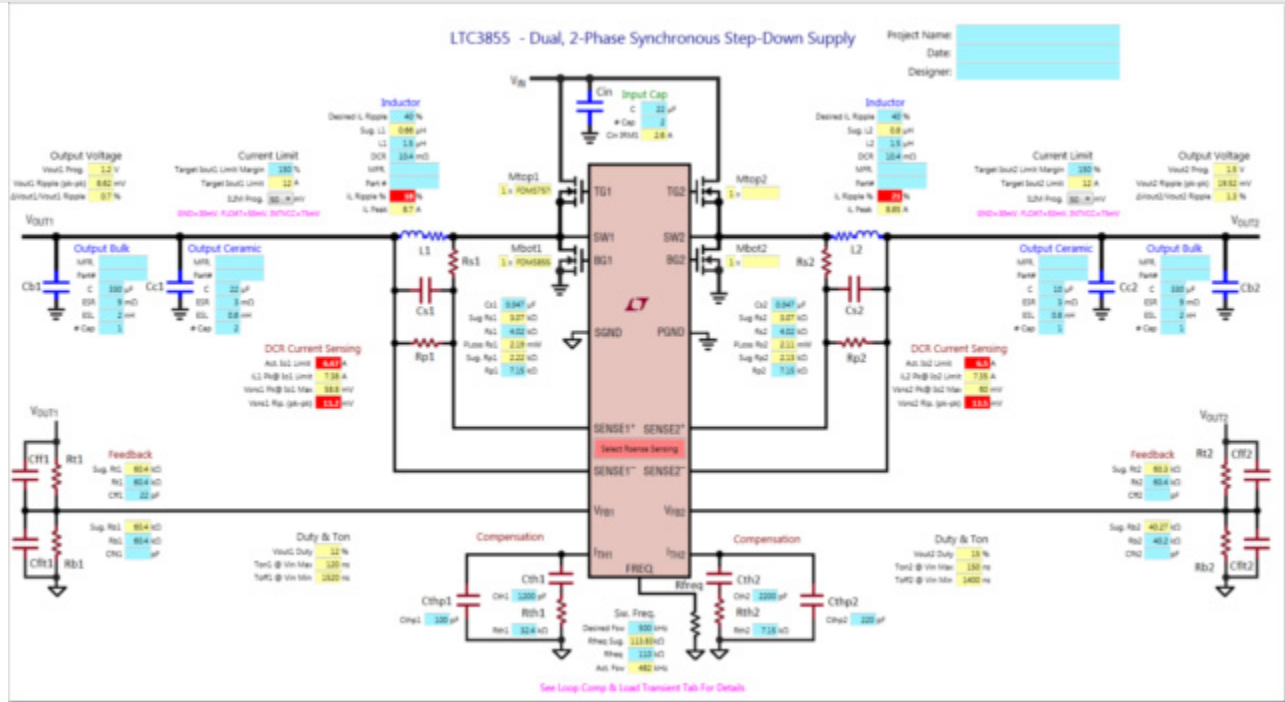

## Schematic Cells :

The schematic is arranged with different cells (textboxes) located in the region of components of the schematic which detail component values and their related calculated parameters. The different types of cells are detailed below.

### Blue cells :

Enter your chosen component values here

### Yellow cells :

Show suggested component values and calculated design parameters to help guide you through the system's component design.

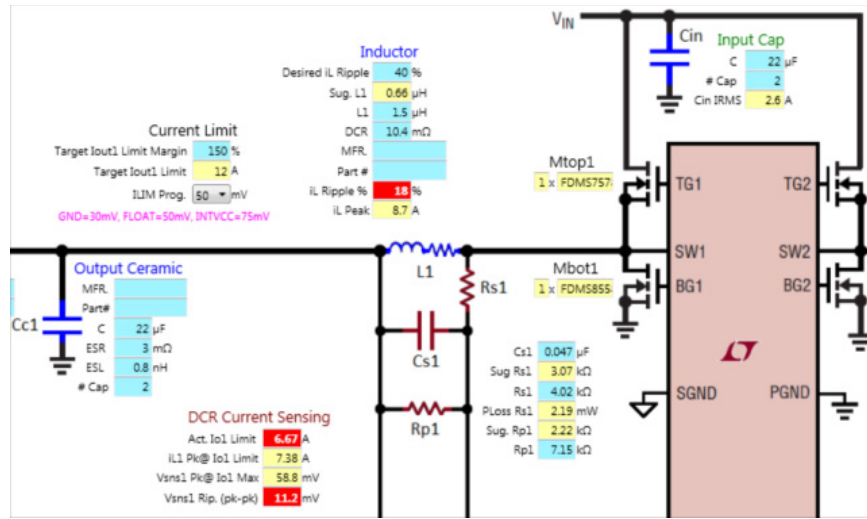

**Red cells :**

Indicate warnings for the supply design. For example, a parameter of the design is outside of the operating limits of the part, outside of the suggested range, or is outside of the range which will meet your requirements. When the cursor is placed over the red cell, a tooltip message becomes available to give you an idea of what the warning is about. Blue cell entries may need to be re-adjusted to get rid of any warnings to guide you towards more appropriate component value choices.

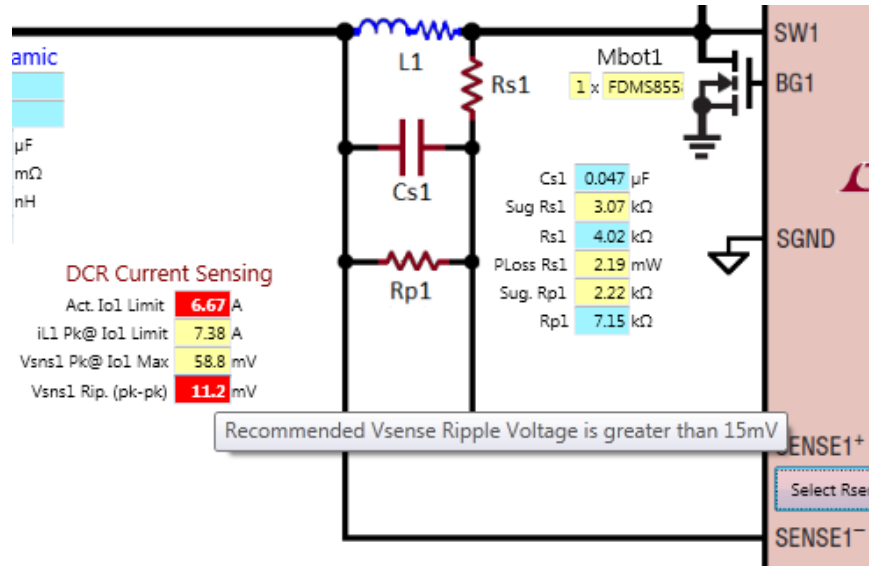

**Schematic Buttons & Drop Down Lists :**

The schematic is also arranged with other controls such as buttons and drop down lists to help select between different part configuration options and select among discrete parameters available for the part

**Selection Buttons :**

Click selection button to toggle between different configuration options for the part. For example, for parts that can be configured for either DCR Current Sensing or Rsense Current Sensing options a button is available on the controller package in the schematic image. For this example you can Click the [Select Rsense Sensing](#) button to elect an Rsense current sensing configuration is desired for the part. The selection then modifies the schematic to reflect your configuration selection.

**Example :**

*DCR Sensing Configuration Selected with Selection Button*

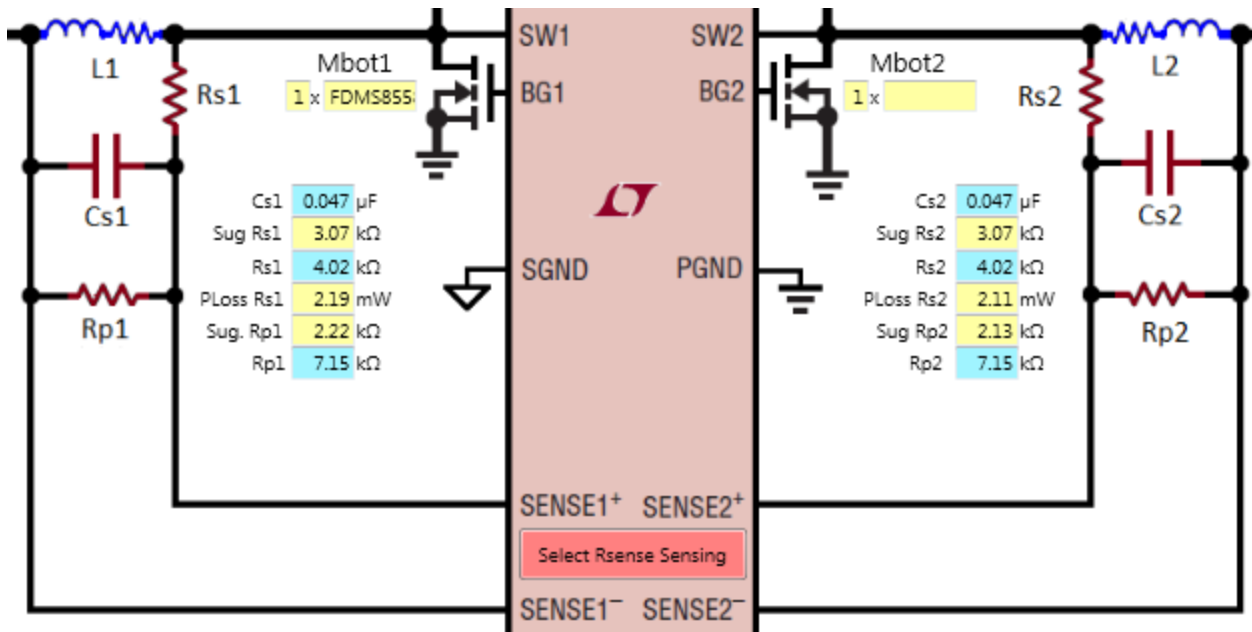

*Rsense Sensing Configuration Selected with Selection Button*

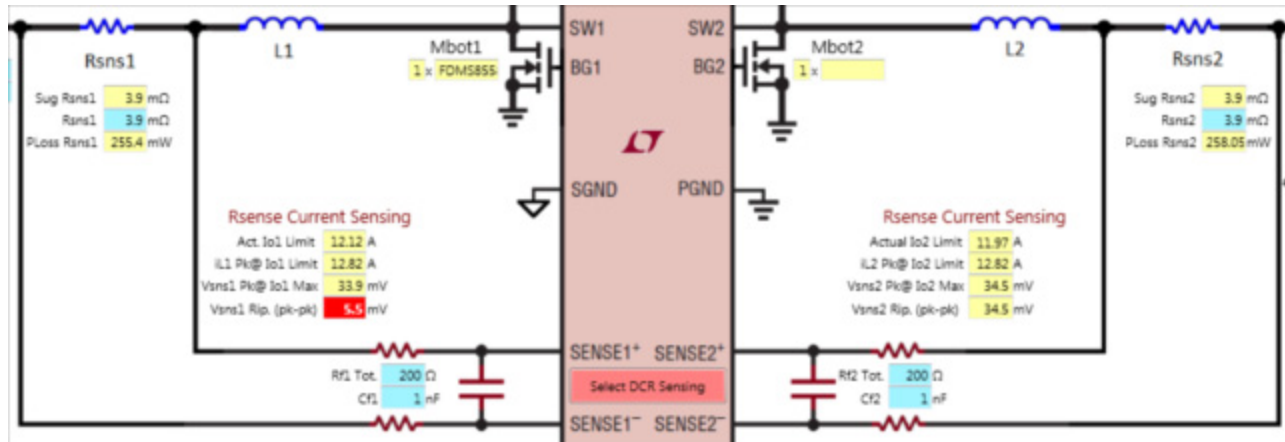

### Drop Down Lists :

Choose a value from the drop down list to select between discrete parameter values available for the part. To use, place cursor over the Drop Down List control to open the drop down list. Move the cursor over a value in the list and click to make the selection of that value. For example, for parts that have an externally programmable maximum current sense voltage threshold (for current limit programming) the drop down list allows the user to select a value from the discrete set of values that are available to be programmed for the part.

### Example :

Programming Current Limit Threshold with Drop Down List

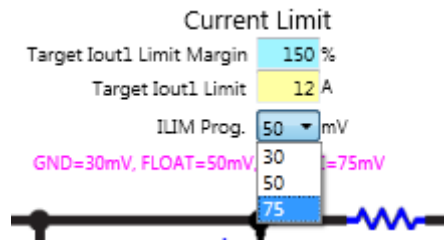

### Schematic Zooming & Panning :

Located above the schematic there are buttons to allow for zooming in and out of the schematic as well as zoom fitting the schematic to the screen. The schematic can also be panned while zooming in.

### Zooming In / Out and Zoom Fit of the Schematic :

For any of the zoom button options, click once to take a zoom step in or out of the schematic. For Zoom Fit, click once to return the schematic zoom level back to normal which fits the schematic to schematic area of the window.



### ***Panning on a zoomed in schematic:***

*To pan around on a zoomed in schematic, click and hold the left mouse button down to "grab" the schematic, a hand icon will appear in place of your cursor. While holding the left mouse button down move the mouse to pan the schematic in the opposite direction.*

### **Schematic Printing & Saving an Image of the Schematic:**

Located above the schematic there are buttons to allow for printing the schematic to a printer as well as saving an image of the schematic to a file for pasting to an external document (such as an email).

#### ***Printing to a printer :***

*Click the button with the printer icon to initiate printing of the schematic image to a printer. Clicking the Print Schematic button opens the familiar Microsoft Windows print dialog window.*

#### ***Capturing an image of the schematic :***

*Click the button with the camera icon to initiate saving of the schematic image to a file. Clicking the Save Schematic Image button opens the familiar Microsoft Windows save file dialog window.*



### **Other Power Stage Design Tab Options :**

The Power Stage Design Tab also includes other useful features such as viewing basic power supply design steps, viewing an example of a recommended layout for the supply as well as exporting the design for simulation in LTSpice.

## Viewing Power Supply Design Steps :

Located above the schematic is a button to allow for viewing the basic recommended design steps to complete a power supply design. Click to open.

### View Design Steps :

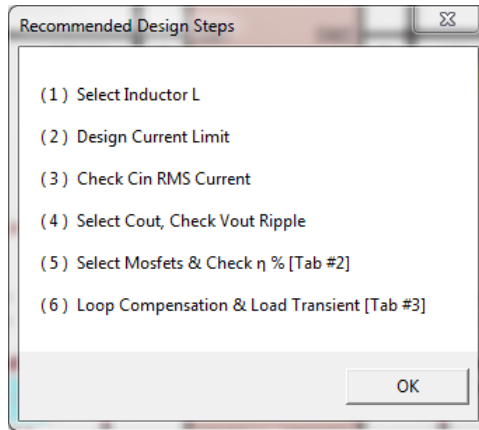

## Viewing a Layout Example :

Located above the schematic is a button to allow for viewing an example of a recommended layout for your supply. Click to open. Within the layout example window there are also options to print the layout example image to a printer as well as saving an image of the example layout to a file.

### View Layout Example :

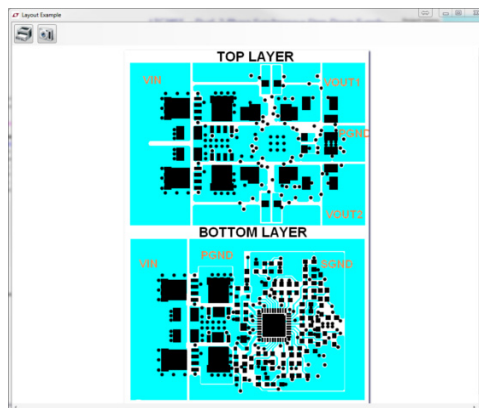



## Exporting your power supply design to LTSpice for Simulation :

The LTpowerCAD™ II Design Tool offers users the ability to simulate their designed circuits with the LTSpice™ simulator, which is a real-time simulation software that can be downloaded freely at :

[LTSpice™](http://www.linear.com/designtools/software) (<http://www.linear.com/designtools/software>)

Located above the schematic is a button to allow for exporting your current power supply design to LTSpice for simulation. LTSpice must be installed. Click the button to export your design. Clicking the button prompts you to first save the exported .asc file before it is automatically opened in LTSpice.

### Export to LTSpice :

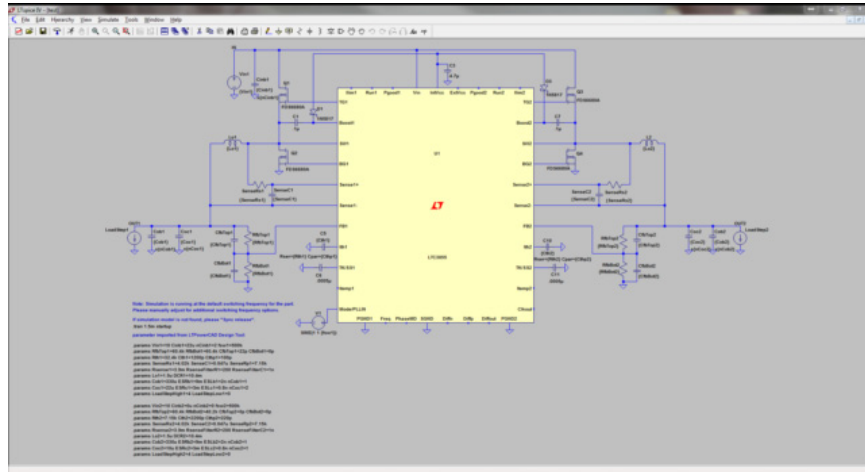

### LTC Toolbox :

Located above the schematic is a button to open the LTC Toolbox to use the generic design tools available there.

### LTC Toolbox :

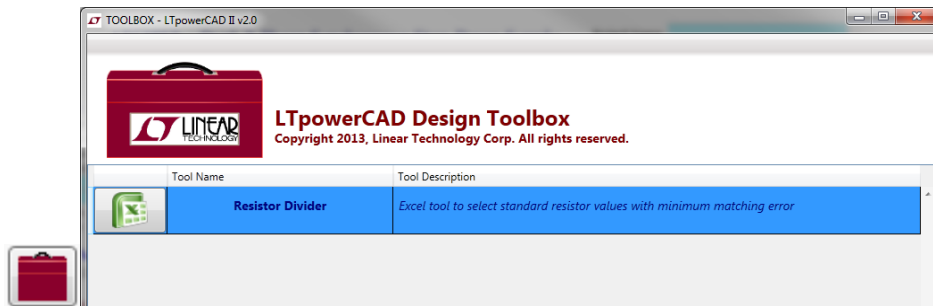

## Saving / Opening LTpowerCAD v2.0 Project Files :

LTpowerCAD™ II v2.0 Design Tool projects can be saved to file for later use.

Saving a design tool project can be done from the main menu bar in the Design Window. Click File --> Save As... to save your project to a file. To open a saved file click File --> Open Project to choose a saved file. The extension for LTpowerCAD II v2.0 design tool projects is ".ltpc". These saved files are associated with the LTpowerCAD II v2.0 program and can be recognized as shown below. Note, as mentioned in the Start Windows & Features section, these saved files can also be opened directly from the Start Window. The saved files can also be opened by double clicking the saved file's icon.

### LTpowerCAD II v2.0 saved design tool project :

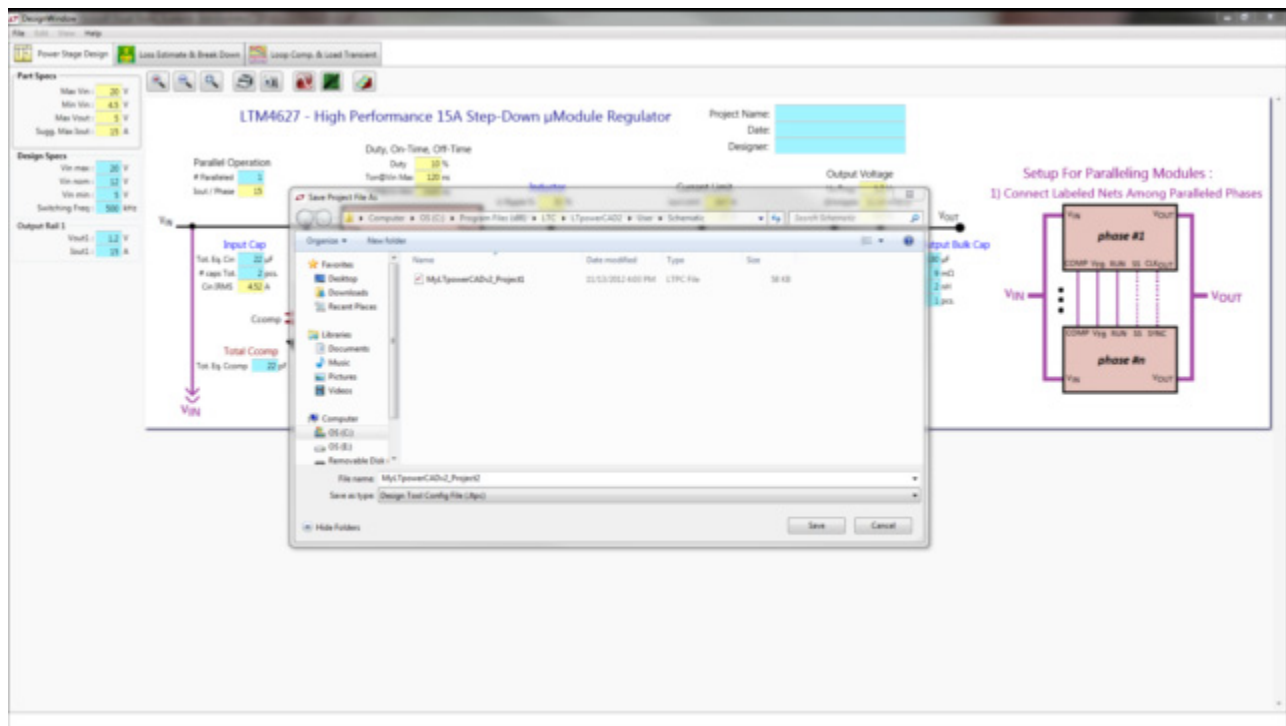
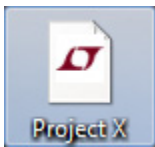

## 2. LOSS ESTIMATE & BREAK DOWN TAB

***The Loss Estimate & Break Down Tab offers estimations for power stage efficiency and power losses to help you optimize your component and operating condition choices to maximize your supply's efficiency and minimize heat due to power loss in your power stage components. Estimations are made for each output rail of your design. Features of the Loss Estimate & Break Down Tab include:***

- *Estimations organized by rail; each rail has its own separate tab*
- *Operating Conditions Summary*
- *Cell Structure*
- *Tab's Cell Types*
- *Efficiency & Power Loss Chart Cursors & adjustable Axes*
- *Switching and conduction losses in each of the power stage mosfets including synchronous fet body diode loss*
- *Conduction losses in the power stage inductor and current sensing elements*
- *Controller LDO losses*
- *Optional External bias voltage entry*
- *Freezable Efficiency & Power Loss curve set for comparing power stage configurations and operating conditions*
- *Power Loss Breakdown Chart*
- *Power mosfet thermal resistance entries to help estimate mosfet case temperature rise*
- *Inductor core loss entry (single value entry, core loss not yet estimated)*
- *Inductor & MOSFET Libraries where you can select from a built in library of mosfets, or add your own favorite parts to the library*
- *Display of full load total Input Power, Output Power, Loss & Efficiency*

***A more detailed description of some of these features available on the Loss Estimate & Break DownTab are shown below:***

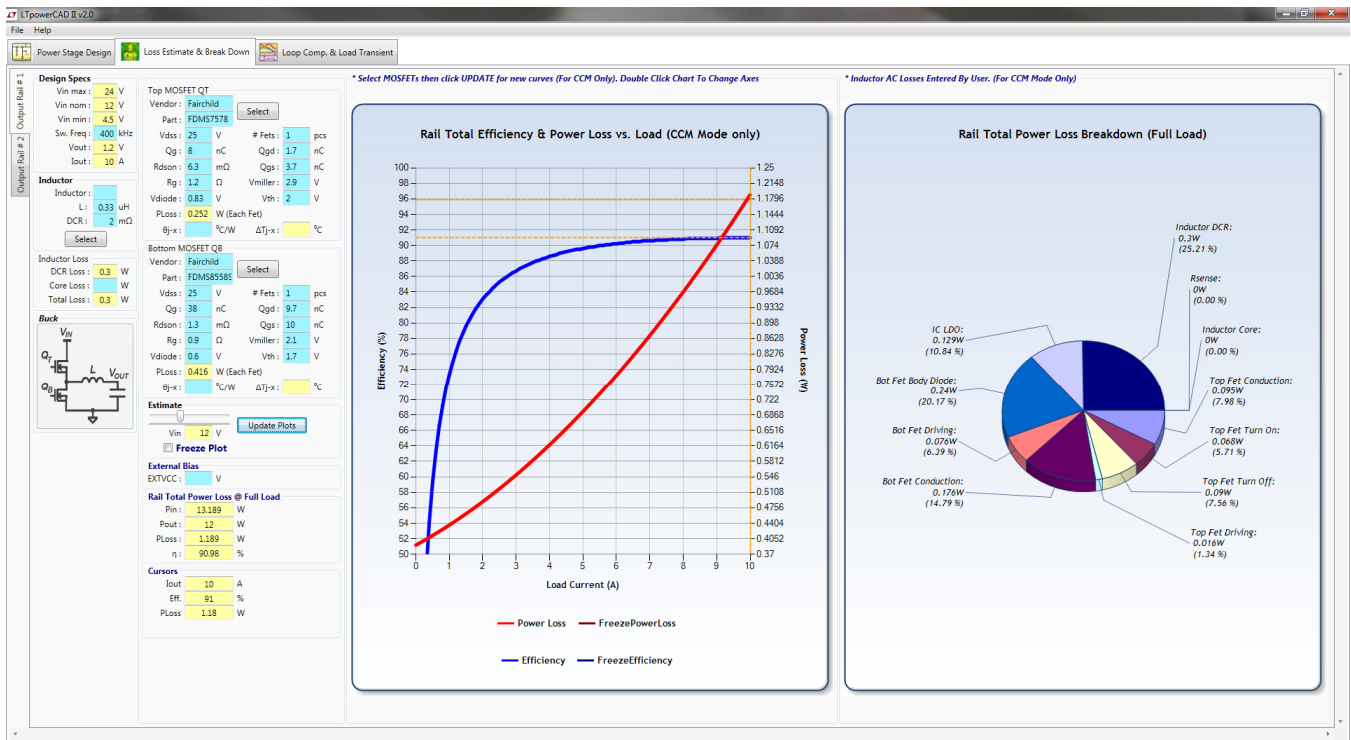

## Each Rail Has Its Own Tab :

Estimations are made for each rail separately, each rail has its own tab. To view estimations for a particular tab in your design, select the tab for the output rail located on the left of the Loss Estimate & Breakdown Tab.

Output Rail # 1  
Output Rail # 2

## Operating Conditions Summary :

A summary section is located in the top left corner of the Loss Estimate & Break Down Tab listing a basic summary of the operating conditions for each output rail in your application.

Design Specs	
Vin max :	24 V
Vin nom :	12 V
Vin min :	4.5 V
Sw. Freq :	400 kHz
Vout :	1.2 V
Iout :	10 A

## Cell Structure :

The Loss Estimate & Break Down Tab is arranged with different cells (textboxes) which detail component values and their related calculated parameters. The different types of cells are detailed below.

## Tab's Cell Types :

### **Blue cells :**

*Enter your chosen component specifications here. For components chosen from the library, the component specs. will be shown here.*

### **Yellow cells :**

*Shows each component's loss and temperature rise estimations as well as total rail input power, output power, loss and efficiency estimated at full load.*

Output Rail # 1  
Output Rail # 2

**Design Specs**

Vin max : 24 V  
 Vin nom : 12 V  
 Vin min : 4.5 V  
 Sw. Freq : 400 kHz  
 Vout : 1.2 V  
 Iout : 10 A

**Inductor**

Inductor :   
 L : 0.33 uH  
 DCR : 2 mΩ

Select

**Inductor Loss**

DCR Loss : 0.3 W  
 Core Loss : W  
 Total Loss : 0.3 W

**Buck**

**Top MOSFET QT**

Vendor : Fairchild  
 Part : FDMS7578

Vdss : 25 V # Fets : 1 pcs  
 Qg : 8 nC Qgd : 1.7 nC  
 Rdson : 6.3 mΩ Qgs : 3.7 nC  
 Rg : 1.2 Ω Vmiller : 2.9 V  
 Vdiode : 0.83 V Vth : 2 V  
 PLoss : 0.252 W (Each Fet)  
 θj-x : °C/W ΔTj-x : °C

**Bottom MOSFET QB**

Vendor : Fairchild  
 Part : FDMS8558

Vdss : 25 V # Fets : 1 pcs  
 Qg : 38 nC Qgd : 9.7 nC  
 Rdson : 1.3 mΩ Qgs : 10 nC  
 Rg : 0.9 Ω Vmiller : 2.1 V  
 Vdiode : 0.6 V Vth : 1.7 V  
 PLoss : 0.416 W (Each Fet)  
 θj-x : °C/W ΔTj-x : °C

**Estimate**

Vin 12 V Update Plots

Freeze Plot

**External Bias**

EXTVCC : V

**Rail Total Power Loss @ Full Load**

Pin : 13.189 W  
 Pout : 12 W  
 PLoss : 1.189 W  
 η : 90.98 %

**Cursors**

Iout 10 A  
 Eff. 91 %  
 PLoss 1.18 W

## Component Libraries :

The Loss Estimate & Break Down Tab is also arranged with a **Select** button within each group of components (*ie Inductor component group, Top Mosfet & Bottom Mosfet component groups*). Click the **Select** button to open the component library where you can choose a component from the built in component library, or add your own favorite component to your user library stored on your system.

Select

### Power MOSFET Library :

The Power MOSFET Library Window is arranged in 2 sections.

- The top half of the window contains a table of built in parts. Critical mosfet specs are shown in the table for each part. To select a component in the library for use click on the row of the component and click the Select button for the section.
- The bottom half of the window is for parts in your User Library which is stored in your system's installation folder.
  - The top half of this section contains a table of parts that are available in your User Library. To select a component in the library for use click on the row of the component and click the Select button for the section.
  - The bottom half of this section contains a row to enter information for a new part you would like to add to you User Library. To add a part to you User Library enter information for the component in the cells provided, these specs. are common specs. that can be found in the component's datasheet. Click the Add Part To Library button to submit adding the part to the library.
- At the bottom of the window is the Vendor Links section which contains icons for various leading component manufacturers. Click one of these icons to open up the vendor's component search web page.

The screenshot shows the Power MOSFET Library window with the following sections:

**Built-In Parts:**

Vendor	Part Name	Vdss (V)	Rdson (mΩ)	Qg (nC)	Qgd (nC)	Qgs (nC)	Rg (Ω)	Vdiode (V)	Vmiller (V)	Vth (V)	Package	Channel Type
Renesas	RJK0301	30	3	32	7	14.5	2	0.84	3	2.5	LFPK	N
Renesas	RJK0305	30	10	8	1.5	3.6	0.6	0.85	3	2.5	LFPK	N
Infineon	BSC019N02	20	1.6	64	11	19	1.90	0.80	1.90	1.0	PG-TDSON	N
Infineon	BSC028N02	20	2.1	40	7	11.4	1.50	0.85	1.90	1.0	PG-TDSON	N
Infineon	BSC046N02	20	3.5	21	4	6.5	1.90	0.90	2.10	1.0	PG-TDSON	N
Infineon	BSC010NE2	25	1.1	31	6.8	11	0.60	0.80	2.40	1.6	PG-TDSON	N
Infineon	BSC010NE2	25	1.1	29	6.9	10	0.60	0.56	2.40	1.6	PG-TDSON	N
Infineon	BSC014NE2	25	1.6	18.7	4.7	6.8	0.60	0.56	2.50	1.6	PG-TDSON	N
Infineon	BSC018NE2	25	1.8	19	4.3	7	0.80	0.85	2.50	1.6	PG-TDSON	N
Infineon	BSC0911ND	25	1.3	25	5.5	8.8	0.60	0.79	2.30	1.6	PG-TISON	N

**User Parts:**

Vendor	Part Name	Vdss (V)	Rdson (mΩ)	Qg (nC)	Qgd (nC)	Qgs (nC)	Rg (Ω)	Vdiode (V)	Vmiller (V)	Vth (V)	Package	Channel Type
Fairchild	FDM5855BS	25	1.3	38	9.7	10	0.90	0.60	2.10	1.7	POWER 51	N
Fairchild	FDM57578	25	6.3	8	1.7	3.7	1.20	0.83	2.90	2.0	POWER 51	N

**Add A New User Part:**

Vendor	Part Name	Vdss (V)	Rdson (mΩ)	Qg (nC)	Qgd (nC)	Qgs (nC)	Rg (Ω)	Vdiode (V)	Vmiller (V)	Vth (V)	Package	Channel Type

**Vendor Links:**

FAIRCHILD SEMICONDUCTOR®    VISHAY    infineon    RENESAS

## Power Inductor Library :

The Power Inductor Library Window is arranged in 2 sections.

- The top half of the window contains a table of built in parts. Critical inductor specs. are shown in the table for each part. To select a component in the library for use click on the row of the component and click the **Select** button for the section.
- The bottom half of the window is for parts in your User Library which is stored in your system's installation folder.
  - The top half of this section contains a table of parts that are available in your User Library. To select a component in the library for use click on the row of the component and click the **Select** button for the section.
  - The bottom half of this section contains a row to enter information for a new part you would like to add to you User Library. To add a part to you User Library enter information for the component in the cells provided, these specs. are common specs. that can be found in the component's datasheet. Click the **Add Part To Library** button to submit adding the part to the library.
- At the bottom of the window is the Vendor Links section which contains icons for various leading component manufacturers. Click one of these icons to open up the vendor's component search web page.

**Built-In Parts :**

Vendor	Part Name	Inductance (µH)	L Tol. (%)	DCR (mΩ)	DCR Tol. (%)	ISat (A)	L Decrease (%)	IHeat (A)	Temp. Rise (C)	Core	L x W x H (mm)
VITEC	59P9903	0.32	10	0.17	10.00	50.00	20.00	80.00	40.00	Ferrite	14.0 x 13.0 x 7.6
VITEC	59P9904	0.44	10	0.17	10.00	35.00	20.00	80.00	40.00	Ferrite	14.0 x 13.0 x 7.6
VITEC	59P9873N	0.22	15	0.29	10.00	47.00	20.00	48.00	40.00	Ferrite	11.0 x 7.5 x 7.2
VITEC	59P9874N	0.30	15	0.29	10.00	34.00	20.00	48.00	40.00	Ferrite	11.0 x 7.5 x 7.2
VITEC	59P9875N	0.40	15	0.29	10.00	23.00	20.00	48.00	40.00	Ferrite	11.0 x 7.5 x 7.2
VITEC	59P9876N	0.51	15	0.29	10.00	17.00	20.00	48.00	40.00	Ferrite	11.0 x 7.5 x 7.2
WURTH	744 301 025	0.22	20	0.32	10.00	65.00	20.00	40.00	50.00	Ferrite	11.3 x 11.0 x 8.9
WURTH	744 301 032	0.33	20	0.32	10.00	46.00	20.00	40.00	50.00	MnZn	11.0 x 11.0 x 9.0
WURTH	744 301 047	0.47	20	0.32	10.00	35.00	20.00	40.00	50.00	MnZn	11.0 x 11.0 x 9.0
WURTH	744 304 022	0.22	20	0.17	10.00	23.00	20.00	26.00	50.00	Ferrite	11.5 x 11.8 x 3.8

Select

**User Parts:**

Vendor	Part Name	Inductance (µH)	L Tol. (%)	DCR (mΩ)	DCR Tol. (%)	ISat (A)	L Decrease (%)	IHeat (A)	Temp. Rise (C)	Core	L x W x H (mm)
COILCRA	SER1360-33	0.33	20	0.77	20	43	20	16.9	40	Ferrite	12.9 x 13 x 5.8

Select Delete

**Add A New User Part:**

Vendor	Part Name	Inductance (µH)	L Tol. (%)	DCR (mΩ)	DCR Tol. (%)	ISat (A)	L Decrease (%)	IHeat (A)	Temp. Rise (C)	Core	L x W x H (mm)

Add Part To Library

Cancel / Exit

**Vendor Links**

Coilcraft WÜRTH ELEKTRONIK VISHAY VITEC TDK muRata sumida Pulse Electronics



## Efficiency & Power Loss Chart & Options :

The Efficiency & Power Loss Chart shows an estimation of efficiency and power loss at the operating conditions over the load current range where inductor valley current is non-negative. The chart includes the option to freeze the curve for a particular operating and configuration condition for comparisons.

### Freezing the chart's estimation curves for comparison:

To freeze the chart's estimation curves click the **Freeze Plot** checkbox. While the checkbox is checked the estimation curves remain frozen. Freezing the curves comes in handy for comparison to another set of operating conditions or another configuration of your power stage component choice. To view the frozen curves against another condition, change the conditions (ie  $V_{in}$ ) and click **Update Plots**. The example below shows a comparison of the efficiency estimation at 12V & 4.5V input voltage.

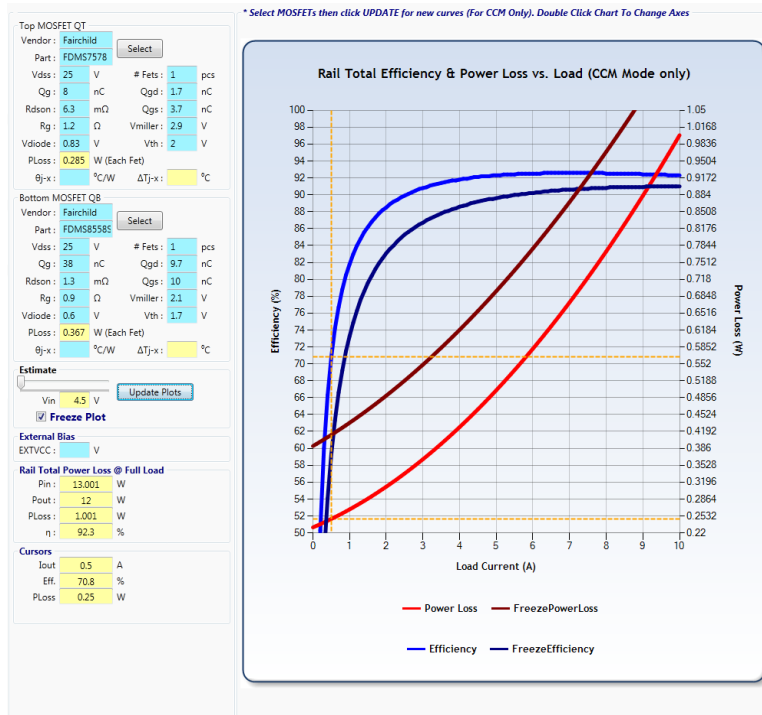

### Cursors:

Hover the mouse above the Efficiency & Power Loss plot. The values for the curve at the mouse position are displayed in the Cursors group box.

Cursors		
Iout	5.6	A
Eff.	92.4	%
Ploss	0.54	W

**Set up Plot Axes Preferences:**

To set up the **Rail Total Efficiency & Power Loss vs. Load** plot, double click on the chart to open the **Setup Axes** window shown below. The window allows for adjusting min, max and interval step values for the 3 axes.

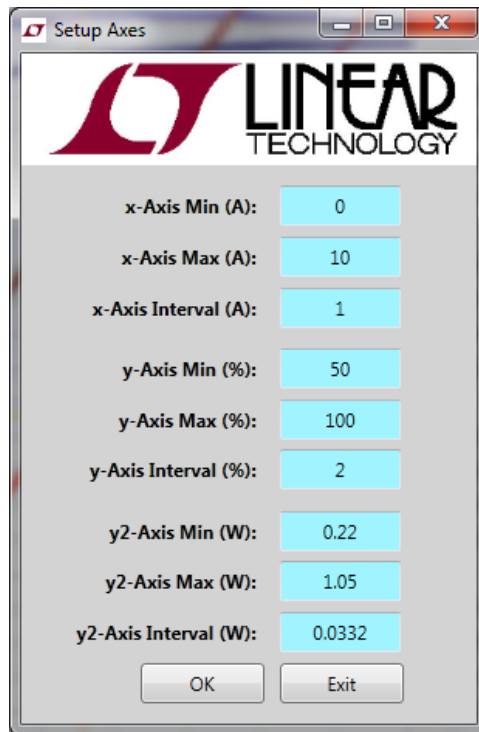

### 3. LOOP COMPENSATION & LOAD TRANSIENT TAB

The Loop Compensation & Load Transient Tab offers estimations for control loop, output impedance & load transient to help you optimize your output capacitor, inductor & compensation components to get the performance you need to meet your application requirements. Estimations are made for each output rail of your design. Features of the Loop Compensation & Load Transient Tab include:

- Estimations organized by rail; each rail has its own separate tab
- Sliding bars for adjusting component values with standard resistor & capacitor values
- Real time estimation allows you to see the trend of by increasing / decreasing component values has on characteristics
- Suggested compensation and feedback network component values based on requirements
- Inductor & Output Capacitor Libraries
- Multiple plots available : Loop Gain, Feedback Network, Output Impedance, Control to Output, Compensator plots
- Plot options : Plot cursors and markers for easy readability of data points and freezing of plots for comparison against other component configurations & operating conditions
- Ability to export plot data to file (such as Microsoft Excel) and Import data from file for comparison to other conditions or against bench test data

A more detailed description of some of these features available on the Loop Compensation & Load Transient Tab are shown below:

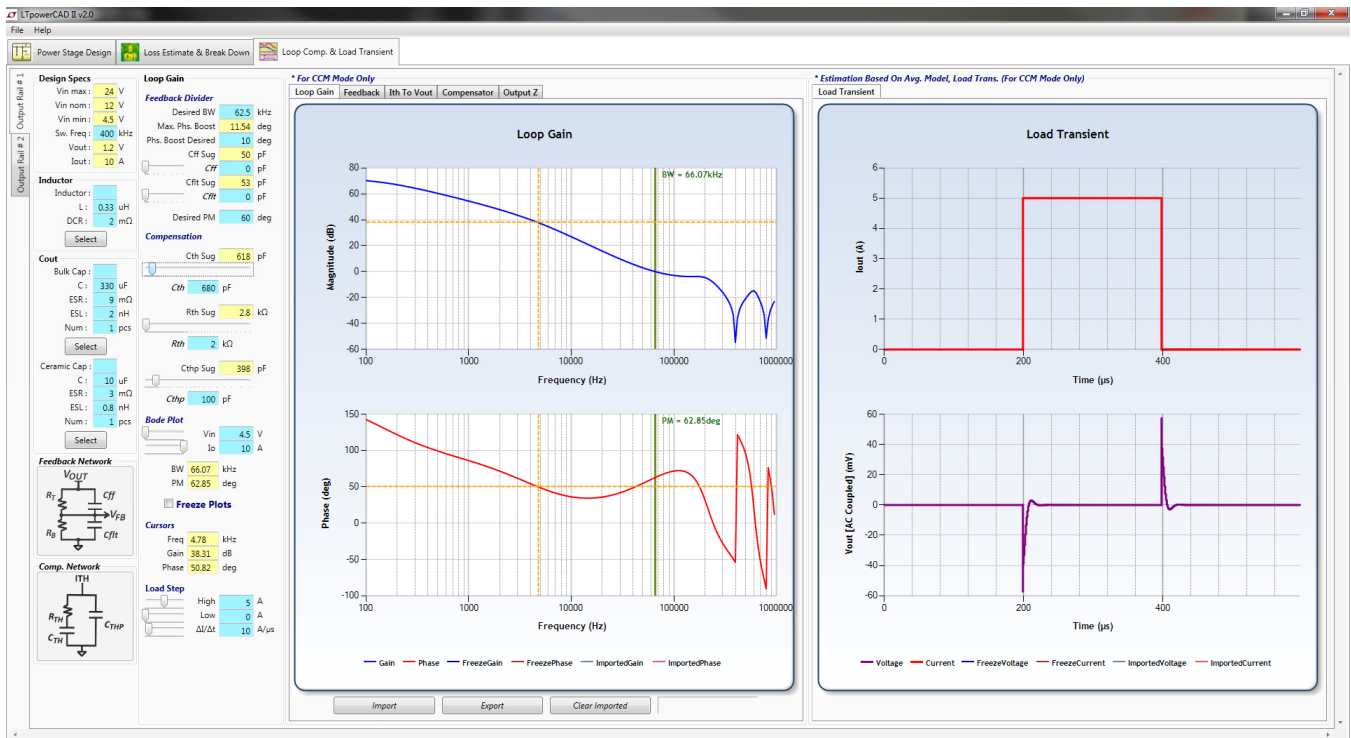

## Each Rail Has Its Own Tab :

Estimations are made for each rail separately, each rail has its own tab. To view estimations for a particular tab in your design, select the tab for the output rail located on the left of the Loop Compensation & Load Transient Tab.

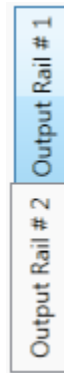

## Operating Conditions Summary :

A summary section is located in the top left corner of the Loop Compensation & Load Transient Tab listing a basic summary of the operating conditions for each output rail in your application.

Design Specs	
Vin max :	24 V
Vin nom :	12 V
Vin min :	4.5 V
Sw. Freq :	400 kHz
Vout :	1.2 V
Iout :	10 A

## Cell Structure :

The Loop Compensation & Load Transient Tab is arranged with different cells (textboxes) which detail component values and their related calculated parameters. The different types of cells are detailed below.

## Tab's Cell Types :

### Blue cells :

Enter your chosen component values & design requirements here. For components chosen from the library, the component specs. will be shown here.

### Yellow cells :

Shows suggested component values as well as plot marker points and plot cursor data for easy readability of plot data

The screenshot displays a control panel for a power converter design tool. It is organized into several sections:

- Design Specs:** Includes input fields for Vin max (2.6 V), Vin min (1.2 V), Vout (1.2 V), Iout (10 A), and switching frequency (500 kHz).
- Inductor:** Fields for inductance L (1.5 uH) and DC resistance DCR (10.4 mΩ).
- Output Capacitor (Cout):** Fields for capacitance C (330 uF), ESR (9 mΩ), ESL (2 nH), and quantity (1 pcs).
- Ceramic Capacitor:** Fields for capacitance C (10 uF), ESR (3 mΩ), ESL (0.8 nH), and quantity (1 pcs).
- Feedback Network:** A schematic diagram showing a feedback network with resistors Rf, Rb, and a capacitor Cf.
- Comp. Network:** A schematic diagram showing a compensation network with resistors Rcp and a capacitor Ccp.
- Loop Gain:** A section for the feedback divider with fields for Desired BW (62.5 kHz), Max. Phs. Boost (19.47 deg), Phs. Boost Desired (10 deg), Ctop Sug (50 pF), Cbot Sug (71 pF), Cbot (0 pF), and Desired PM (60 deg).
- Compensation:** Fields for Cth Sug (160 pF), Cth (2200 pF), Rth Sug (1.86 kΩ), and Rth (7.15 kΩ).
- Bole Plot:** Fields for Vin (20 V) and Io (10 A).
- Curors:** Fields for Freq (0.51 kHz), Gain (37.07 dB), and Phase (87.96 deg).
- Load Step:** Fields for High (5 A), Low (0 A), and ΔI/Δt (10 A/μs).

## Component Libraries :

The Loop Gain & Load Transient Tab is also arranged with a Select button within each group of components (ie Inductor component group, Bulk & Ceramic Output Capacitor groups). Click the Select button to open the component library where you can choose a component from the built in component library, or add your own favorite component to your user library stored on your system.

Select

## Power Inductor Library :

The Power Inductor Library Window is arranged in 2 sections.

- The top half of the window contains a table of built in parts. Critical inductor specs. are shown in the table for each part. To select a component in the library for use click on the row of the component and click the Select button for the section.
- The bottom half of the window is for parts in your User Library which is stored in your system's installation folder.
  - The top half of this section contains a table of parts that are available in your User Library. To select a component in the library for use click on the row of the component and click the Select button for the section.
  - The bottom half of this section contains a row to enter information for a new part you would like to add to you User Library. To add a part to you User Library enter information for the component in the cells provided, these specs. are common specs. that can be found in the component's datasheet. Click the Add Part To Library button to submit adding the part to the library.
- At the bottom of the window is the Vendor Links section which contains icons for various leading component manufacturers. Click one of these icons to open up the vendor's component search web page.

Power MOSFET Library

**Built-In Parts :**

Vendor	Part Name	Vdss (V)	Rdson (mΩ)	Qg (nC)	Qgd (nC)	Qgs (nC)	Rg (Ω)	Vdiode (V)	Vmiller (V)	Vth (V)	Package	Channel Type
Renesas	RJK0301	30	3	32	7	14.5	2	0.84	3	2.5	LFPK	N
Renesas	RJK0305	30	10	8	1.5	3.6	0.6	0.85	3	2.5	LFPK	N
Infineon	BSC019N02	20	1.6	64	11	19	1.90	0.80	1.90	1.0	PG-TDSON	N
Infineon	BSC026N02	20	2.1	40	7	11.4	1.50	0.85	1.90	1.0	PG-TDSON	N
Infineon	BSC046N02	20	3.5	21	4	6.5	1.90	0.90	2.10	1.0	PG-TDSON	N
Infineon	BSC010NE2	25	1.1	31	6.8	11	0.60	0.80	2.40	1.6	PG-TDSON	N
Infineon	BSC010NE2	25	1.1	29	6.9	10	0.60	0.56	2.40	1.6	PG-TDSON	N
Infineon	BSC014NE2	25	1.6	18.7	4.7	6.8	0.60	0.56	2.50	1.6	PG-TDSON	N
Infineon	BSC018NE2	25	1.8	19	4.3	7	0.80	0.85	2.50	1.6	PG-TDSON	N
Infineon	BSC0911ND	25	1.3	25	5.5	8.8	0.60	0.79	2.30	1.6	PG-TISON	N

Select Show N-Fets Only Show P-Fets Only

**User Parts:**

Vendor	Part Name	Vdss (V)	Rdson (mΩ)	Qg (nC)	Qgd (nC)	Qgs (nC)	Rg (Ω)	Vdiode (V)	Vmiller (V)	Vth (V)	Package	Channel Type
Fairchild	FDM8558S	25	1.7	39	3.7	10	0.90	0.60	2.10	1.7	POWER 54	N
Fairchild	FDM57578	25	6.3	8	1.7	3.7	1.20	0.83	2.90	2.0	POWER 54	N

Select Delete Show N-Fets Only Show P-Fets Only





**Add A New User Part:**

Vendor	Part Name	Vdss (V)	Rdson (mΩ)	Qg (nC)	Qgd (nC)	Qgs (nC)	Rg (Ω)	Vdiode (V)	Vmiller (V)	Vth (V)	Package	Channel Type

Add Part To Library

Cancel / Exit

**Vendor Links**

## Power Capacitor Library :

The Power Capacitor Library Window is arranged in 2 sections.

- The top half of the window contains a table of built in parts. Critical capacitor specs. are shown in the table for each part. To select a component in the library for use click on the row of the component and click the Select button for the section.
- The bottom half of the window is for parts in your User Library which is stored in your system's installation folder.
  - The top half of this section contains a table of parts that are available in your User Library. To select a component in the library for use click on the row of the component and click the Select button for the section.
  - The bottom half of this section contains a row to enter information for a new part you would like to add to you User Library. To add a part to you User Library enter information for the component in the cells provided, these specs. are common specs. that can be found in the component's datasheet. Click the Add Part To Library button to submit adding the part to the library.
- At the bottom of the window is the Vendor Links section which contains icons for various leading component manufacturers. Click one of these icons to open up the vendor's component search web page.

The screenshot shows the 'Power CAPACITOR Library' window. It is divided into several sections:

- Built-In Parts:** A table listing various capacitor models from SANYO with their specifications.
- User Parts:** A table for user-defined parts, currently containing one entry: SANYO 165EPC100R.
- Add A New User Part:** A form for adding new parts to the user library.
- Vendor Links:** A section with logos for AVX, Panasonic, KEMET, TDK, and muRata.

Vendor	Part Name	Capacitance (	ESR (mΩ)	ESL (nH)	Max Ripple Current (A RMS)	Voltage Rating (V)	Cap. Type	Case Size	Length (mm)	Width (mm)	Height (mm)	Diameter (mm)
SANYO	165EPC100R	100	10	3.2	4.5	16	OS-CON					
SANYO	4TPE150M	150	18	1.6	2.8	4	POSCAP					
SANYO	6TPE150M	150	18	1.6	2.8	6.3	POSCAP					
SANYO	10TPE150M	150	15	1.9	3.6	10	POSCAP					
SANYO	20SEP150M	150	20	5.8	4.32	20	OS-CON					
SANYO	20SEEP150	150	20	5.8	4.32	20	OS-CON					
SANYO	165EP180M	180	20	4.1	3.64	16	OS-CON					
SANYO	165EPC180R	180	16	4.1	4.36	16	OS-CON					
SANYO	165EPC180Y	180	16	4.3	4.36	16	OS-CON					
SANYO	165EQ180R	180	20	4.1	3.64	16	OS-CON					

Vendor	Part Name	Capacitance (	ESR (mΩ)	ESL (nH)	Max Ripple Current (A RMS)	Voltage Rating (V)	Cap. Type	Case Size	Length (mm)	Width (mm)	Height (mm)	Diameter (mm)
SANYO	165EPC100R	100	24	2.6	2.4	16	OS-CON	C6	6	6	6	6

## Loop Compensation & Load Transient Tab's Plots :

The Loop Compensation & Load Transient Tab has many plots available to detail the key performance characteristics of your power supply. The plots include gain and phase plots for total Loop Gain, Feedback Network, Output Impedance, Control To Output and Compensator Network as well as a Load Transient estimation plot. Estimations are updated instantly as you make changes to the component values to help you intuitively fine tune your supply's performance characteristics. All plots include crosshair cursors to make it easy to read data point values in the plots as well as plot markers to quickly view key parameters of the loop characteristic. Estimations are for CCM mode (continuous conduction mode) only.

### Loop Gain Plot :

A loop gain estimation is available to help you choose the right components to ensure proper bandwidth, phase and gain margins for the control loop. To view the loop gain plot, click the Loop Gain tab in the plot window.

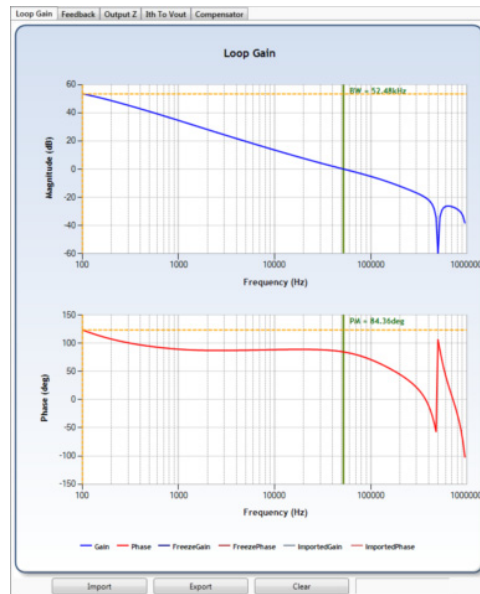



### Feedback Network Plot :

A feedback network gain estimation is available to help you choose the right components feedback network compensation components to ensure proper bandwidth, phase and gain margins for the control loop. To view the feedback network plot, click the Feedback Network tab in the plot window.

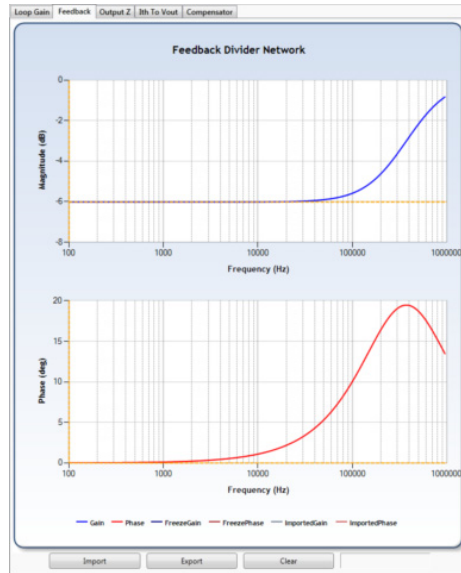

### Output Impedance Plot :

An output impedance estimation is available to help you choose the right components to satisfy your output impedance requirements. To view the output impedance plot, click the Output Z tab in the plot window.

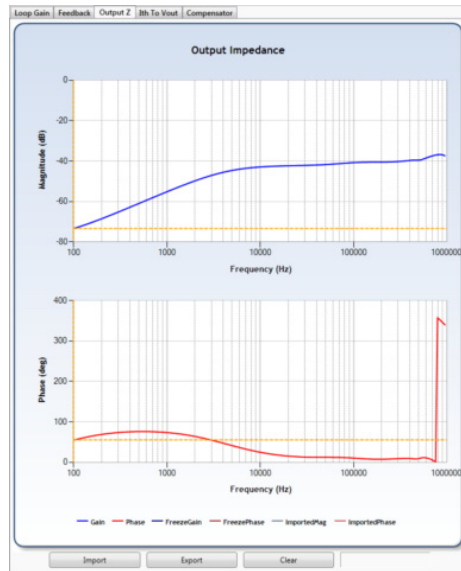

### Control To Output Plot :

A control to output estimation is available to help you choose the right components to ensure proper bandwidth, phase and gain margins for the control loop. To view the control to output plot, click the ITH to Vout tab in the plot window.

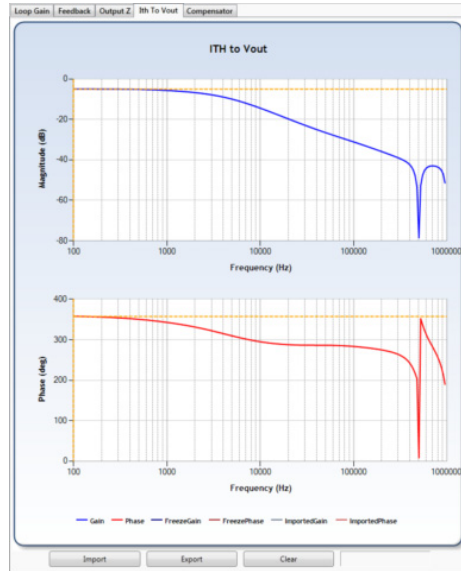

### Compensator Plot :

A compensator estimation is available to help you choose the right components to ensure proper bandwidth, phase and gain margins for the control loop. To view the compensator plot, click the Compensator tab in the plot window.

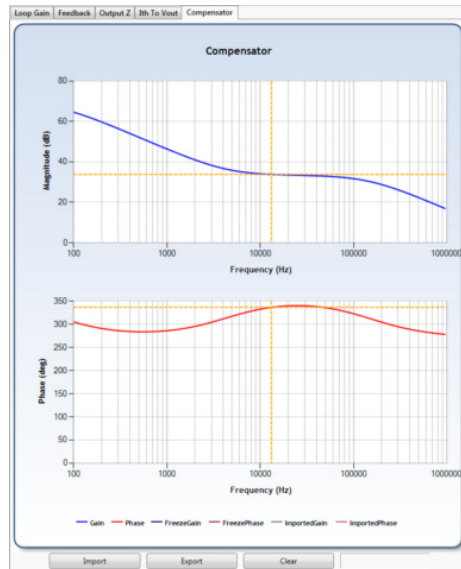

### Load Transient Plot :

A load transient estimation is available to help you choose the right components to meet your load transient overshoot / undershoot and settling time requirements for your expected load step's magnitude and slew rate. To view the load transient plot, click the Load Transient tab in the plot window.

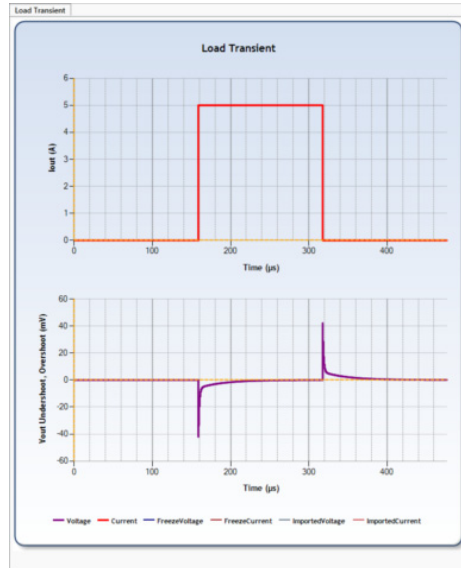

### Freezing Plots :

All plots can be frozen in their current condition with the available Freeze Plot button for comparison against other operating conditions and component configurations.

#### Freeze Plot :

To freeze a plot, click the Freeze Plot checkbox located to the left of the left-most plotting pane. The data for all plots in the Loop Compensation & Load Transient Tab will remain frozen while this checkbox is checked. Frozen data is represented by the darker shaded curves. Click the checkbox again to uncheck and remove the frozen data from the plot.

Freeze Plots

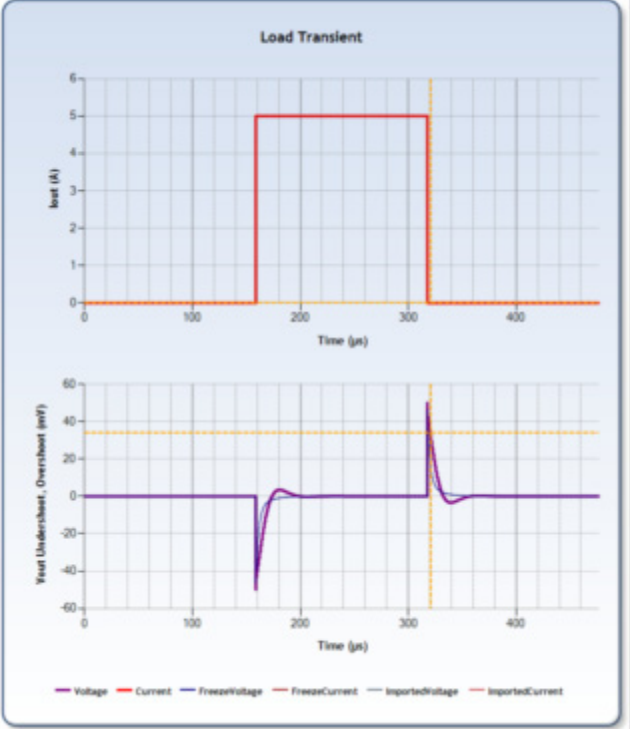
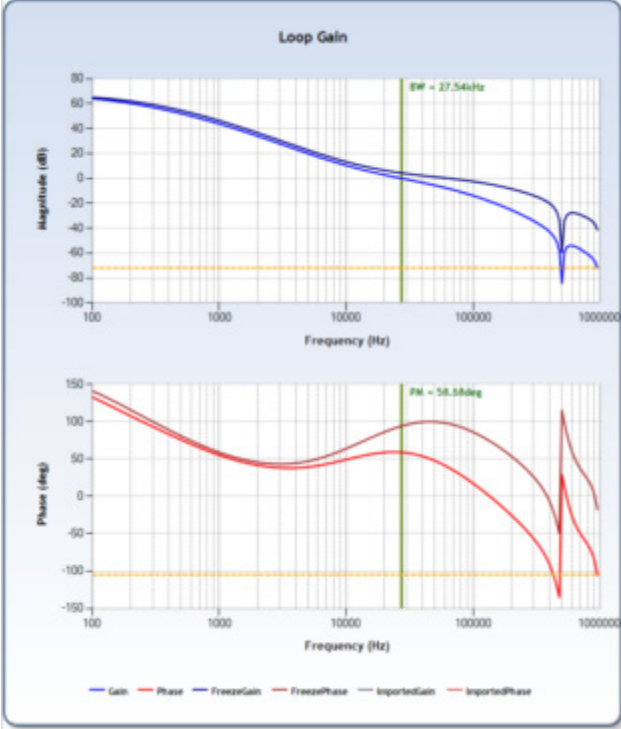

## Exporting / Importing Plot Data :

Data for each of the plots in the left plot pane can be either exported to a file for view / manipulation outside of LTpowerCAD II as well as imported from an external file, such as bench test data file generated from a Bode Plotter, for comparisons.

### Exporting Plot Data:

Data can be exported from a plot to be saved to file or loaded directly to an excel file for editing. To begin exporting plot data, select the plot's tab to show the plot whose data you would like to export and click the **Export** button below the plot. You will then be prompted to save the data to a file and then asked if you would like to automatically load this data into a Microsoft Excel Template included in your installation file folder.

Export

Example : Data Exported to Microsoft Excel Template

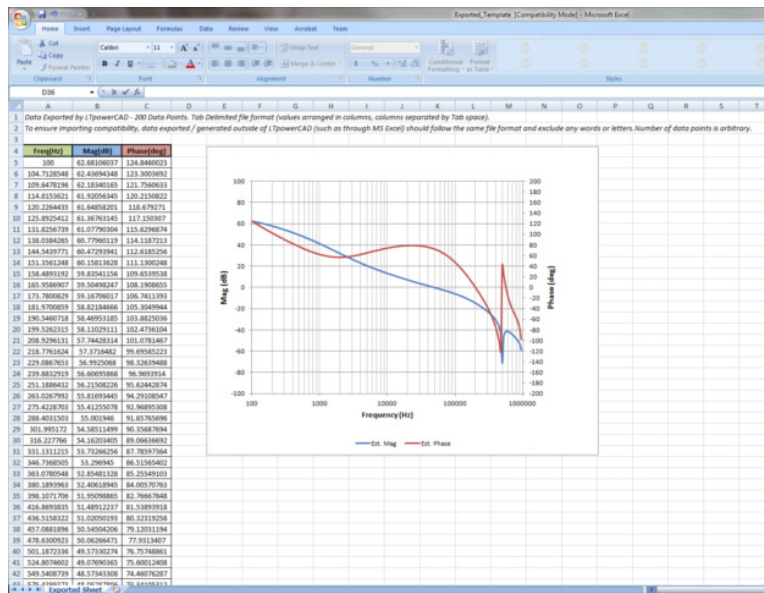

### Importing Plot Data:

Data can be imported from an external data file, such as a previously saved LTpowerCAD II estimation plot or bench test data generated by a Bode Plotter for example, for comparison. To begin importing plot data, select the plot's tab to show the plot whose data you would like to import and click the Import button below the plot. You will then be prompted to select the data file to be imported. The data will be loaded within the plot to view a comparison of the current estimation to the imported plot data.



Example : Data Imported from a Saved Data File

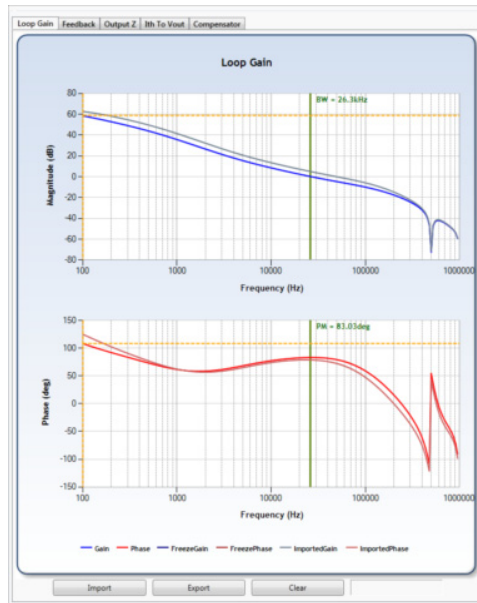

To Clear Imported data from the plot, click the Clear button below the plot.

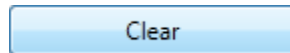

### 3. APPENDIX

#### 3.1 LINEAR TECHNOLOGY CORPORATION LTPOWERCAD™ II DESIGN TOOL LICENSE AGREEMENT

##### Linear Technology Corporation LTpowerCAD™II Design Tool License Agreement

**INSTALLING AND USING THE SOFTWARE ACCOMPANYING THIS LICENSE INDICATES YOUR ACCEPTANCE OF THESE TERMS AND CONDITIONS UNLESS YOU HAVE A DIFFERENT LICENSE AGREEMENT SIGNED BY LINEAR TECHNOLOGY CORPORATION. READ ALL OF THE TERMS AND CONDITIONS OF THIS LICENSE AGREEMENT PRIOR TO INSTALLING OR USING THE SOFTWARE. IF YOU DO NOT ACCEPT THESE TERMS, YOU MUST DELETE THE SOFTWARE FROM YOUR HARDWARE.**

**PLEASE NOTE THAT YOU MAY NOT USE, COPY, MODIFY OR TRANSFER THE PROGRAM OR DOCUMENTATION OR ANY COPY, EXCEPT AS EXPRESSLY PROVIDED IN THIS AGREEMENT.**

INSTALLING AND USING THE SOFTWARE ACCOMPANYING THIS LICENSE INDICATES YOUR ACCEPTANCE OF THESE TERMS AND CONDITIONS UNLESS YOU HAVE A DIFFERENT LICENSE AGREEMENT SIGNED BY LINEAR TECHNOLOGY CORPORATION. READ ALL OF THE TERMS AND CONDITIONS OF THIS LICENSE AGREEMENT PRIOR TO INSTALLING OR USING THE SOFTWARE. IF YOU DO NOT ACCEPT THESE TERMS, YOU MUST DELETE THE SOFTWARE FROM YOUR HARDWARE.

PLEASE NOTE THAT YOU MAY NOT USE, COPY, MODIFY OR TRANSFER THE PROGRAM OR DOCUMENTATION OR ANY COPY, EXCEPT AS EXPRESSLY PROVIDED IN THIS AGREEMENT.

##### 1. LICENSE

THIS SOFTWARE PROGRAM (THE "PROGRAM") AND THE ACCOMPANYING ON-LINE READ-ME AND HELP FILES (THE "DOCUMENTATION") ARE LICENSED, NOT SOLD, TO YOU BY LINEAR TECHNOLOGY CORPORATION. ("LICENSOR"). THE TERM "PROGRAM" SHALL ALSO INCLUDE ANY UPDATES OF THE PROGRAM LICENSED TO YOU BY LICENSOR. SUBJECT TO THE TERMS OF THIS AGREEMENT, YOU HAVE A NON-EXCLUSIVE AND NONTRANSFERABLE RIGHT TO USE THE PROGRAM AND DOCUMENTATION FOR NON-RESALE OR RENTAL OF THE PROGRAM, EDUCATIONAL, DESIGN, EVALUATION OR PERSONAL PURPOSES ONLY. YOU MAY USE THIS PROGRAM ON A SINGLE COMPUTER LOCATED IN THE UNITED STATES AND ITS TERRITORIES OR ANY OTHER COUNTRY TO WHICH THIS PROGRAM IS LEGALLY EXPORTED. THIS PROGRAM IS "IN USE" ON A COMPUTER WHEN IT IS LOADED INTO THE TEMPORARY MEMORY (I.E. RAM) OR INSTALLED INTO THE PERMANENT MEMORY (E.G. HARD DRIVE, CD-ROM OR OTHER STORAGE DEVICE) OF THAT COMPUTER, EXCEPT THAT A COPY INSTALLED ON A NETWORK SERVER FOR THE SOLE PURPOSE OF DISTRIBUTION TO OTHER COMPUTERS IS NOT "IN USE." IF YOU PERMANENTLY INSTALL THE PROGRAM ON THE HARD DISK OR OTHER STORAGE DEVICE OF A COMPUTER (OTHER THAN A NETWORK SERVER) AND YOU USE THAT COMPUTER MORE THAN 80% OF THE TIME IT IS IN USE, THEN YOU MAY ALSO USE THE PROGRAM ON A PORTABLE OR HOME COMPUTER, OTHERWISE, YOU ARE REQUIRED TO OBTAIN A SEPARATE LICENSE TO USE THE PROGRAM ON A PORTABLE OR HOME COMPUTER. YOU AGREE TO USE YOUR BEST EFFORTS TO PREVENT AND PROTECT THE CONTENTS OF THE PROGRAM AND DOCUMENTATION FROM UNAUTHORIZED DISCLOSURE OR USE. LICENSOR AND ITS LICENSORS RESERVE ALL RIGHTS NOT EXPRESSLY GRANTED TO YOU. LICENSOR'S LICENSORS ARE THE INTENDED THIRD PARTY BENEFICIARIES OF THIS AGREEMENT AND HAVE THE EXPRESS RIGHT TO RELY UPON AND DIRECTLY ENFORCE THE TERMS SET FORTH

HEREIN.

## **2. LIMITATION ON USE**

YOU MAY NOT RENT, LEASE, SELL OR OTHERWISE TRANSFER OR DISTRIBUTE COPIES OF THE PROGRAM OR DOCUMENTATION TO OTHERS. YOU MAY NOT MODIFY OR TRANSLATE THE PROGRAM OR THE DOCUMENTATION WITHOUT THE PRIOR WRITTEN CONSENT OF LICENSOR. YOU MAY NOT REVERSE ASSEMBLE, REVERSE COMPILE OR OTHERWISE ATTEMPT TO CREATE THE SOURCE CODE FROM THE PROGRAM. YOU MAY NOT USE LICENSOR'S NAME OR OTHER TRADEMARKS OR REFER TO LICENSOR OR LICENSOR'S PRODUCTS DIRECTLY OR INDIRECTLY IN ANY PAPERS, ARTICLES, ADVERTISEMENTS, SALES PRESENTATIONS, NEWS RELEASES OR RELEASES TO ANY THIRD PARTY WITHOUT THE PRIOR WRITTEN APPROVAL OF LICENSOR FOR EACH SUCH USE. YOU MAY NOT RELEASE THE RESULTS OF ANY PERFORMANCE OR FUNCTIONAL EVALUATION OF THE PROGRAM TO ANY THIRD PARTY WITHOUT PRIOR WRITTEN APPROVAL OF LICENSOR FOR EACH SUCH RELEASE.

## **3. TRANSFER**

YOU MAY NOT SUBLICENSE, ASSIGN, DELEGATE, RENT, LEASE, TIME-SHARE OR OTHERWISE TRANSFER THIS LICENSE OR ANY OF THE RELATED RIGHTS OR OBLIGATIONS FOR ANY REASON. ANY ATTEMPT TO MAKE ANY SUCH SUBLICENSE, ASSIGNMENT, DELEGATION OR OTHER TRANSFER BY YOU SHALL BE VOID. YOU MAY PHYSICALLY TRANSFER THE PROGRAM FROM ONE COMPUTER TO ANOTHER PROVIDED THAT YOU DO NOT RETAIN ANY COPIES OF THE PROGRAM, INCLUDING ANY COPIES STORED ON THE FIRST COMPUTER.

## **4. BACKUP AND COPYRIGHT**

THE PROGRAM AND RELATED DOCUMENTATION ARE COPYRIGHTED BY LICENSOR AND ITS LICENSORS. YOU MAY MAKE ONE COPY OF THE PROGRAM FOR BACKUP PURPOSES IF LICENSOR'S COPYRIGHT NOTICE IS INCLUDED ON SUCH COPY AND TO LOAD THE PROGRAM INTO THE COMPUTER AS PART OF EXECUTING THE PROGRAM. YOU MAY MAKE ONE COPY OF THE DOCUMENTATION AND PRINT ONE COPY OF ANY ON-LINE DOCUMENTATION OR OTHER MATERIALS PROVIDED TO YOU IN ELECTRONIC FORM. ANY AND ALL OTHER COPIES OF THE PROGRAM AND ANY COPY OF THE DOCUMENTATION MADE BY YOU ARE IN VIOLATION OF THIS LICENSE.

## **5. OWNERSHIP**

YOU AGREE THAT THE PROGRAM AND DOCUMENTATION BELONG TO LICENSOR AND ITS LICENSORS. YOU AGREE THAT YOU NEITHER OWN NOR HEREBY ACQUIRE ANY CLAIM OR RIGHT OF OWNERSHIP TO THE PROGRAM AND DOCUMENTATION OR TO ANY RELATED PATENTS, COPYRIGHTS, TRADEMARKS OR OTHER INTELLECTUAL PROPERTY. LICENSOR AND ITS LICENSORS RETAIN ALL RIGHT, TITLE AND INTEREST IN AND TO THE DOCUMENTATION AND THE PROGRAM AND ALL COPIES THEREOF AT ALL TIMES, REGARDLESS OF THE FORM OR MEDIA IN OR ON WHICH THE ORIGINAL OR OTHER COPIES MAY SUBSEQUENTLY EXIST. THIS LICENSE IS NOT A SALE OF THE ORIGINAL OR ANY SUBSEQUENT COPY. ALL CONTENT ACCESSED THROUGH THE PROGRAM IS THE PROPERTY OF THE APPLICABLE CONTENT OWNER AND MAY BE PROTECTED BY APPLICABLE COPYRIGHT LAW. THIS LICENSE GIVES YOU NO RIGHTS TO SUCH CONTENT.

## **6. TERM AND TERMINATION**

THIS LICENSE IS EFFECTIVE UNTIL TERMINATED. YOU MAY TERMINATE THIS LICENSE AT ANY TIME BY DESTROYING THE PROGRAM AND DOCUMENTATION AND THE PERMITTED BACKUP COPY. THIS LICENSE AUTOMATICALLY TERMINATES IF YOU FAIL TO COMPLY WITH ITS TERMS AND CONDITIONS. YOU AGREE THAT, UPON SUCH TERMINATION, YOU WILL EITHER DESTROY (OR PERMANENTLY ERASE) ALL COPIES OF THE PROGRAM AND DOCUMENTATION, OR RETURN THE ORIGINAL PROGRAM AND DOCUMENTATION TO LICENSOR, TOGETHER WITH ANY OTHER MATERIAL YOU HAVE RECEIVED FROM LICENSOR IN CONNECTION WITH THE PROGRAM.



## **7. DISCLAIMER OF WARRANTY**

LICENSOR AND ITS LICENSORS PROVIDE THE PROGRAM AND THE DOCUMENTATION "AS IS" WITHOUT WARRANTY OF ANY KIND EITHER EXPRESS, IMPLIED OR STATUTORY, INCLUDING BUT NOT LIMITED TO THE IMPLIED WARRANTIES OF MERCHANTABILITY, FITNESS FOR A PARTICULAR PURPOSE, OR INFRINGEMENT OF THIRD-PARTY INTELLECTUAL PROPERTY RIGHTS. ALL RISK OF QUALITY AND PERFORMANCE OF THE PROGRAM AND THE DOCUMENTATION IS WITH YOU. SHOULD THE PROGRAM PROVE DEFECTIVE, YOU AND NOT LICENSOR ASSUME THE ENTIRE COST OF ANY SERVICE AND REPAIR. THIS DISCLAIMER OF WARRANTY CONSTITUTES AN ESSENTIAL PART OF THIS AGREEMENT.

## **8. LIMITATION OF REMEDIES**

IN NO EVENT WILL LICENSOR OR ITS LICENSORS BE LIABLE FOR ANY INDIRECT DAMAGES OR OTHER RELIEF ARISING OUT OF YOUR USE OR INABILITY TO USE THE PROGRAM INCLUDING, BY WAY OF ILLUSTRATION AND NOT LIMITATION, LOST PROFITS, LOST BUSINESS OR LOST OPPORTUNITY, OR ANY SPECIAL, INCIDENTAL OR CONSEQUENTIAL OR EXEMPLARY DAMAGES, INCLUDING LEGAL FEES, ARISING OUT OF SUCH USE OR INABILITY TO USE THE PROGRAM, EVEN IF LICENSOR, ITS LICENSORS OR AN AUTHORIZED LICENSOR DEALER, DISTRIBUTOR OR SUPPLIER HAS BEEN ADVISED OF THE POSSIBILITY OF SUCH DAMAGES, OR FOR ANY CLAIM BY ANY OTHER PARTY.

## **9. APPLICABLE LAW**

THIS LICENSE WILL BE GOVERNED BY THE LAWS OF THE STATE OF CALIFORNIA, WITHOUT REFERENCE TO CONFLICTS OF LAWS PRINCIPLES. THE UNITED NATIONS CONVENTION ON CONTRACTS FOR THE SALE OF GOODS DOES NOT APPLY TO THIS LICENSE.

## **10. EXPORT CONTROLS**

YOU SHALL ONLY USE THE *SOFTWARE* IN COMPLIANCE WITH ALL APPLICABLE LAWS AND REGULATIONS, INCLUDING WITHOUT LIMITATION EXPORT CONTROL LAWS. YOU AGREE THAT YOU WILL NOT DIRECTLY OR INDIRECTLY EXPORT THE *SOFTWARE* TO ANOTHER COUNTRY EXCEPT IN FULL COMPLIANCE WITH ALL APPLICABLE UNITED STATES FEDERAL LAWS AND REGULATIONS AND OTHER LAWS AND REGULATIONS RELATING TO EXPORTS AND IMPORTS. YOU WILL NOT EXPORT/REEXPORT, DIRECTLY OR INDIRECTLY, ANY SOFTWARE, INFORMATION OR TECHNICAL DATA ACQUIRED UNDER THIS AGREEMENT OR THE "DIRECT PRODUCT" THEREOF TO ANY COUNTRY FOR WHICH THE UNITED STATES GOVERNMENT OR ANY AGENCY THEREOF, AT THE TIME OF EXPORT, REQUIRES AN EXPORT LICENSE OR OTHER GOVERNMENTAL APPROVAL, WITHOUT FIRST OBTAINING SUCH LICENSE OR APPROVAL. THE TERM "DIRECT PRODUCT" AS USED HEREIN MEANS THE IMMEDIATE PRODUCT (INCLUDING PROCESSES AND SERVICES) PRODUCED DIRECTLY BY THE USE OF THE TECHNICAL DATA OR INFORMATION. IN ADDITION TO THE ABOVE, THE *SOFTWARE* AND/OR ANY "DIRECT PRODUCT" THEREOF, MAY NOT BE USED BY, OR EXPORTED, TRANSFERRED OR REEXPORTED TO (i) ANY U.S. OR U.N. OR EU-SANCTIONED OR EMBARGOED COUNTRY, OR TO NATIONALS OR RESIDENTS OF SUCH COUNTRIES; (ii) ANY PERSON, ENTITY, ORGANIZATION, OR OTHER PARTY IDENTIFIED ON THE U.S. DEPARTMENT OF TREASURE'S LISTS OF "SPECIALLY DESIGNATED NATIONALS AND BLOCKED PERSONS" (iii) ANY ASSOCIATIONS, INDIVIDUALS, COMPANIES, ENTITIES, ORGANIZATIONS FOUND IN THE U.S. DEPARTMENT OF COMMERCE'S TABLE OF DENIAL ORDERS OR ENTITY LIST, AS PUBLISHED AND REVISED FROM TIME TO TIME (COLLECTIVELY KNOWN AS THE "DENIED PARTIES LIST" OR "PROHIBITED PARTIES LIST"); AND/OR (iv) ANY UNAUTHORIZED OR PROHIBITED END-USER ENGAGED IN ANY PROHIBITED ACTIVITIES RELATED TO WEAPONS OF MASS DESTRUCTION, INCLUDING WITHOUT LIMITATION, ACTIVITIES RELATED TO THE DESIGN, DEVELOPMENT, PRODUCTION OR USE OF NUCLEAR WEAPONS, MATERIALS, OR FACILITIES, MISSILE OR THE SUPPORT OF MISSILE PROJECTS, AND CHEMICAL OR BIOLOGICAL WEAPONS. YOU UNDERSTAND THE FOREGOING OBLIGATIONS ARE LEGAL REQUIREMENTS AND AGREE THAT THEY SHALL SURVIVE ANY EXPIRATION OR TERMINATION OF THIS AGREEMENT.

### **11. U.S. GOVERNMENT END USERS**

THE PROGRAM IS A "COMMERCIAL ITEM," AS THAT TERM IS DEFINED AT 48 C.F.R. 2.101 (OCT. 1995), CONSISTING OF "COMMERCIAL COMPUTER SOFTWARE" AND "COMMERCIAL COMPUTER SOFTWARE DOCUMENTATION," AS SUCH TERMS ARE USED IN 48 C.F.R. 12.212 (SEPT. 1995). CONSISTENT WITH 48 C.F.R. 12.212 AND 48 C.F.R. 227.7202-1 THROUGH 227.7202-4 (JUNE 1995), ALL U.S. GOVERNMENT END USERS ACQUIRE ONLY THOSE RIGHTS IN THE PROGRAM AND THE DOCUMENTATION THAT ARE PROVIDED BY THIS AGREEMENT.

### **12. NO OTHER AGREEMENTS**

THIS AGREEMENT AND THE INTRODUCTION OF IT ON THE LINEAR TECHNOLOGY WEB SITE, CONSTITUTES THE ENTIRE AGREEMENT BETWEEN THE PARTIES WITH RESPECT TO THE PROGRAM AND THE DOCUMENTATION, AND SUPERSEDES ANY OTHER WRITTEN OR ORAL AGREEMENT.

### **13. SEVERABILITY**

IF ANY PROVISION OF THIS AGREEMENT IS HELD INVALID, THE REMAINDER OF THIS AGREEMENT SHALL CONTINUE IN FULL FORCE AND EFFECT.

IF YOU HAVE ANY QUESTIONS, PLEASE CONTACT IN WRITING: LINEAR TECHNOLOGY CORPORATION AT 1630 MCCARTHY BOULEVARD, MILPITAS, CALIFORNIA 95035-7417.

## **3.2 LOAD TRANSIENT PREDICTION**

### **Load Transient Prediction Results**

The design tool program provides an approximation of the output voltage overshoot/undershoot waveform during load transients. This approximation is calculated based on the average small-signal model of the power supply. Therefore, it does NOT take into consideration possible large-signal non-linear effects that may exist in the real experimental test with a large and very fast load step. In reality, sometimes the overshoot/undershoot is higher than the small-signal estimation. Even so the transient waveforms give the designer a good starting point to estimate the output voltage overshoot/undershoot and required minimum output capacitance. To verify the design, it is important and recommended to actually build the circuit and evaluate its performance.

The output transient waveform is the averaged waveform over a switching cycle. The switching frequency ripple is not included in this waveform. The user also needs to include the switching ripple for the total transient spike.

## **3.3 ACCURACY OF THE LTPOWERCAD II DESIGN TOOL**

### **LTpowerCAD II Design Tool Accuracy**

As always, Linear Technology has made best efforts to support our customers with a quality design tool. However, due to model limitations and external component value variations, it remains the customer's responsibility to verify the program's calculation

results by actually building the circuit and evaluating its performance.

Linear Technology verifies the loop Bode Plot and load transient for each Linear Technology Monolithic and uModule part released in the LTpowerCAD™ II Design Tool with real bench tests on the Linear Technology Standard Demo Circuit Boards. Therefore we have a good level of confidence in the accuracy of our loop designs.

Users are always welcome to contact their local Linear Technology Sales Office for help.

### 3.4 LTpowerCAD™ II DESIGN TOOL SUPPORTED LTC PRODUCTS LIST

#### Design Tool Supported LTC Products List

Supported parts are updated regularly. To view all the latest parts please click "Sync Release" located on the main page of the program. If there is not a suitable part available in the design tool list which satisfies your application requirements, we still most likely have the part you are looking for.

Please check the Linear Technology parametric search tables at [http://parametric.linear.com/switching\\_regulator](http://parametric.linear.com/switching_regulator) to locate other LTC parts that may satisfy your application's needs.

### 3.5 LTpowerCAD™ II DESIGN TOOL CONTACT INFORMATION

#### LTpowerCAD™ Support Contact Information

Please contact Linear Technology LTpowerCAD Design Tool development group at [LTpowerCAD@linear.com](mailto:LTpowerCAD@linear.com) for any question in using this software.

### 3.6 LTpowerCAD™ II DESIGN TOOL RELEASE INFORMATION

## **LTpowerCAD™ Design Tool Release Information**

Version v2.0 : Beta Release November 2012

Version II v2.0 : 1st Release June 2013