

Connector: MMCX Jack (Female Socket)		
Termination: PCB Surface Mount		
Connector Part	Material	Finish
Bodies	Body: Brass	Gold
Center Contact	Pin: Be Cu	Gold
Insulator	PTFE	-

REVISIONS			
REV	DESCRIPTION	DATE	APPV
C	ADDED NEW TITLE BLOCK.	11-JUN-12	SAH
D	UPDATED SHEET SIZE/DIMENSIONS. ADDED DETAIL VIEW.	3-JUL-18	CLL
E	ADDED TAPE AND REEL SPECIFICATIONS	4-MAR-20	CLL

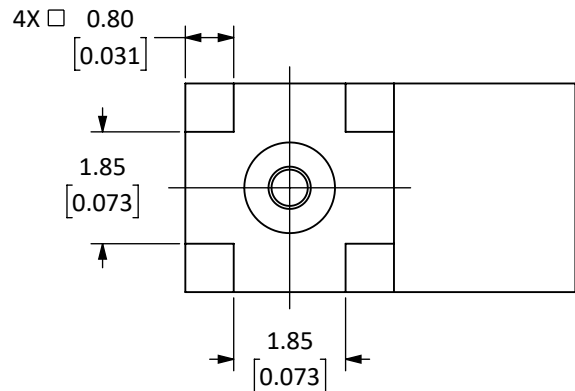
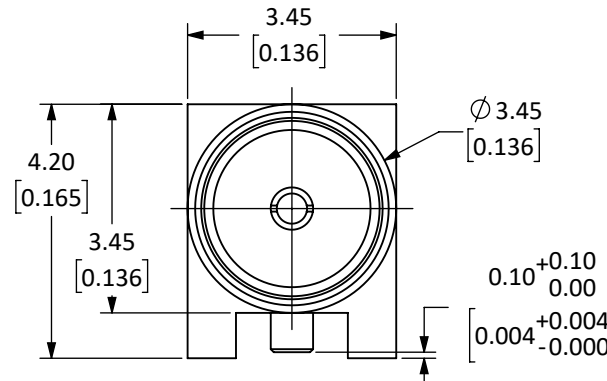
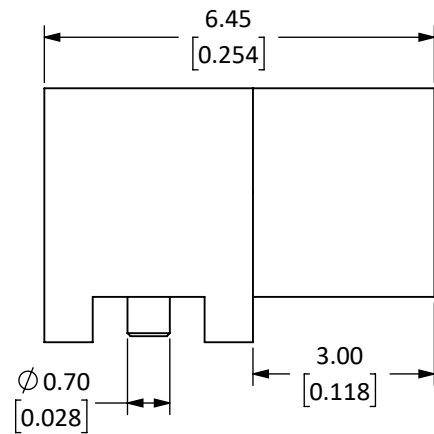

NOTES: (UNLESS OTHERWISE SPECIFIED)

1. ALL DIMENSIONS ARE IN MILLIMETERS [INCHES].
2. DIMENSIONS APPLY AFTER FINISHING.
3. MANUFACTURE TO BE COMPLIANT WITH EU RoHS DIRECTIVE, USE MATERIALS THAT DO NOT CONTAIN REACH SUBSTANCES OF VERY HIGH CONCERN >1000ppm, AND USE DRC CONFLICT-FREE SOURCED MATERIALS.
4. SAFETY BREAK ALL SHARP CORNERS AND EDGES 0.5 MAXIMUM.
5. SEE TABLE I FOR ELECTRICAL SPECIFICATIONS. (SHEET 2)
6. SEE TABLE II FOR ENVIRONMENTAL SPECIFICATIONS. (SHEET 2)
7. SEE TABLE III FOR MECHANICAL SPECIFICATIONS. (SHEET 2)

WARNING: THIS DRAWING CONTAINS PROPRIETARY INFORMATION THAT IS THE SOLE PROPERTY OF LINX TECHNOLOGIES, AND SHALL BE TREATED AS SUCH. NO DISCLOSURE OR REPRODUCTION OF THIS DOCUMENT IS PERMITTED, IN WHOLE OR IN PART, WITHOUT THE EXPRESS WRITTEN PERMISSION OF LINX TECHNOLOGIES OR ITS DESIGNATED AGENTS.

Linxx 159 ORT LANE
MERLIN, OR 97532

TITLE:
**MMCX FEMALE RIGHT ANGLE,
SURFACE MOUNT**

MATERIAL:	TOLERANCES: 0.50 [.020]-5.00 [.200]= ±0.20 [.008] 5.00 [.200]-30.00 [1.200]= ±0.40 [.016] 30.0 [1.20]-120.0 [4.75]= ±0.60 [0.24] 120.0 [4.75]-315.0 [12.40]= ±1.0 [.040]	PROJECTION: 
	FINISH:	ANGLES: ±1°
	DRAWN: M. SCHULTE	DT: 26-FEB-20
	ENGR: S. HOGAN	DT: 3-MAR-20

SIZE	DWG. NO.	REV
A	CONMMCX002-SMD	E
SCALE: 8:1	DO NOT SCALE DRAWING	SHEET 1 OF 2



SCALE 1 : 1

5 TABLE I

Electrical Data	Detail
Impedance	50 Ω
Frequency Range	0 to 6 GHz
Insulation Resistance	≥ 5000 MΩ
Voltage Rating	750 V RMS
Contact Resistance	Center ≤ 5.0 m Ω Outer: ≤ 1.0 m Ω
VSWR	≤ 1.35 @ 6 GHz

6 TABLE II

Environmental Data	Detail
Corrosion (Salt Spray)	MIL-STD-202 METHOD 101 TEST CONDITION B
Thermal Shock	MIL-STD-202 METHOD 107 TEST CONDITION B
Vibration	MIL-STD-202 METHOD 204 TEST CONDITION D
Mechanical Shock	MIL-STD-202 METHOD 213 TEST CONDITION I
Temperature Range	-65 °C to +165 °C
Environmental Compliance	RoHS

7 TABLE III

Mechanical Data	Detail
Mounting Type	Panel Mount, Surface Mount, Right Angle
Fastening Type	Snap-On Coupling
Connector Durability	500 cycles min.
Weight	0.37 g (0.01 oz)

TAPE DIMENSIONS

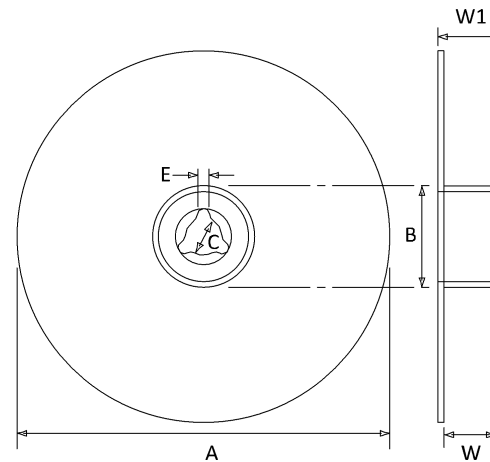
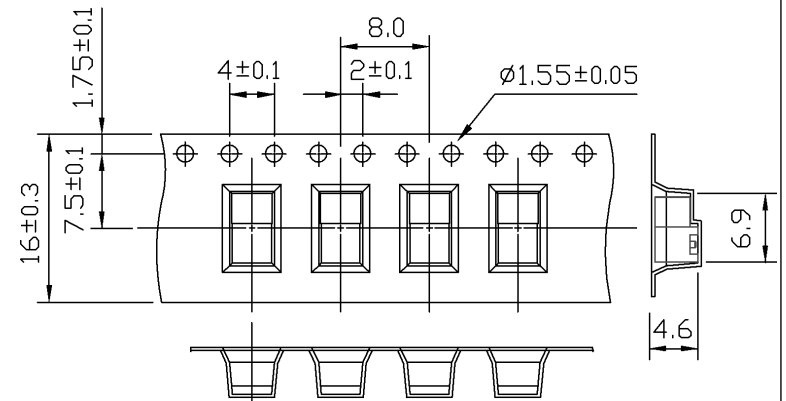

REEL DIMENSIONS		
SYMBOL	DIMENSION (mm)	TOLERANCE
A	330	+ 1.50
B	100	+ 1.00
C	13.3	+ 0.30
E	2.5	+ 0.30
W	24.5	+1.50 -0.10
W1	28.7	+ 0.40

1750 PCS/REEL

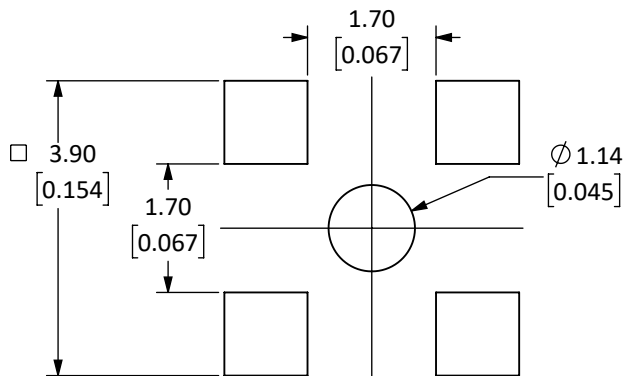

RECOMMENDED FOOTPRINT

SIZE	DWG. NO.	REV
A	CONMMCX002-SMD	E
SCALE: 4:1	DO NOT SCALE DRAWING	SHEET 2 OF 2