

BQ28Z610

Technical Reference



Literature Number: SLUUA65D
April 2014–Revised January 2020

Preface	8
1 Introduction	9
2 Protections	10
2.1 Introduction.....	10
2.2 Cell Undervoltage Protection	10
2.3 Cell Overvoltage Protection	10
2.4 Overcurrent in Charge Protection	11
2.5 Overcurrent in Discharge Protection.....	12
2.6 Hardware-Based Protection.....	12
2.6.1 Overload in Discharge Protection	12
2.6.2 Short Circuit in Charge Protection	13
2.6.3 Short Circuit in Discharge Protection	13
2.7 Temperature Protections	13
2.8 Overtemperature in Charge Protection	13
2.9 Overtemperature in Discharge Protection.....	14
2.10 Undertemperature in Charge Protection	14
2.11 Undertemperature in Discharge Protection	14
2.12 Precharge Timeout Protection.....	15
2.13 Fast Charge Timeout Protection	15
3 Permanent Fail	16
3.1 Introduction.....	16
3.2 Safety Cell Overvoltage Permanent Fail	16
3.3 Voltage Imbalance at Rest Permanent Fail.....	17
3.4 Voltage Imbalance Active Permanent Fail	17
3.5 Charge FET Permanent Failure	17
3.5.1 Description	17
3.5.2 Feature Enable/Disable.....	18
3.6 Discharge FET Permanent Failure.....	18
3.6.1 Description	18
3.6.2 Feature Enable/Disable.....	18
3.7 Instruction Flash (IF) Checksum Permanent Fail	18
3.8 Data Flash (DF) Permanent Fail	18
4 Advanced Charge Algorithm	19
4.1 Introduction.....	19
4.2 Charge Temperature Ranges.....	19
4.3 Voltage Range	20
4.4 Charging Current	21
4.5 Charging Voltage	21
4.6 Valid Charge Termination	22
4.7 Charge and Discharge Alarms	22
4.8 Terminate Charge and Discharge Alarms.....	23
4.9 Precharge	24
4.10 Maintenance Charge.....	24
4.11 BROADCAST Mode	24

4.12	Charge Disable and Discharge Disable	24
4.13	Charge Inhibit	25
4.14	Charge Suspend	25
5	Power Modes	26
5.1	Introduction	26
5.2	NORMAL Mode	26
5.3	SLEEP Mode	26
5.3.1	Device Sleep	26
5.3.2	IN SYSTEM SLEEP Mode	26
5.3.3	AltManufacturerAccess() MAC Sleep	27
5.3.4	Wake Function	27
5.4	SHUTDOWN Mode	27
5.4.1	Voltage Based Shutdown	27
5.4.2	AltManufacturerAccess() MAC Shutdown	28
5.4.3	Time Based Shutdown	28
5.4.4	Emergency FET Shutdown	28
6	Gauging	29
6.1	Introduction	29
6.2	Impedance Track Configuration	29
6.3	Gas Gauge Modes	30
6.4	QMax and Ra	32
6.4.1	QMax Initial Values	33
6.4.2	QMax Update Conditions	33
6.4.3	Fast QMax Update Conditions	33
6.4.4	QMax and Fast QMax Update Boundary Check	34
6.4.5	Ra Table Initial Values	34
6.4.6	Ra Table Update Conditions	34
6.5	FullChargeCapacity (FCC), RemainingCapacity (RemCap), and RelativeStateOfCharge (RSOC)	36
6.6	Impedance Track (IT) Configuration Options	36
6.7	State-of-Health (SOH)	37
6.8	Battery Trip Point (BTP)	37
7	Cell Balancing	39
7.1	Introduction	39
7.2	Cell Balancing Setup	39
7.3	Cell Balancing Operation	43
8	Lifetime Data Collection	46
8.1	Description	46
9	Device Security	47
9.1	Description	47
9.2	SHA-1 Description	47
9.3	HMAC Description	47
9.4	Authentication	48
9.5	Security Modes	48
9.5.1	SEALING and UNSEALING Data Flash	49
9.5.2	SEALED to UNSEALED	49
9.5.3	UNSEALED to FULL ACCESS	49
10	Manufacture Production	50
10.1	Manufacture Testing	50
10.2	Calibration	50
11	Calibration	52
11.1	Cell Voltage Calibration	52
11.2	VC2 (BAT) Voltage Calibration	53

11.3	PACK Voltage Calibration	53
11.4	Current Calibration	54
11.4.1	CC Offset Calibration	54
11.4.2	Board Offset Calibration	55
11.4.3	CC Gain/Capacity Gain Calibration	55
11.5	Temperature Calibration	56
11.5.1	Internal Temperature Sensor Calibration	56
11.5.2	TS1 Calibration	56
12	I²C Commands	57
12.1	Standard Data Commands	57
12.1.1	0x00/01 ManufacturerAccess() Control	58
12.1.2	0x02/03 AtRate()	59
12.1.3	0x04/05 AtRateTimeToEmpty()	59
12.1.4	0x06/07 Temperature()	59
12.1.5	0x08/09 Voltage()	59
12.1.6	0x0A/0B BatteryStatus()	59
12.1.7	0x0C/0D Current()	60
12.1.8	0x0E/0F MaxError()	60
12.1.9	0x10/11 RemainingCapacity()	61
12.1.10	0x12/13 FullChargeCapacity()	61
12.1.11	0x14/15 AverageCurrent()	61
12.1.12	0x16/17 AverageTimeToEmpty()	61
12.1.13	0x18/19 AverageTimeToFull()	61
12.1.14	0x1A/1B StandbyCurrent()	61
12.1.15	0x1C/1D StandbyTimeToEmpty()	61
12.1.16	0x1E/1F MaxLoadCurrent()	62
12.1.17	0x20/21 MaxLoadTimeToEmpty()	62
12.1.18	0x22/23 AveragePower()	62
12.1.19	0x24/25 BTPDischargeSet()	62
12.1.20	0x26/27 BTPChargeSet()	62
12.1.21	0x28/29 InternalTemperature()	62
12.1.22	0x2A/2B CycleCount()	63
12.1.23	0x2C/2D RelativeStateOfCharge()	63
12.1.24	0x2E/2F State-of-Health (SOH)	63
12.1.25	0x30/31 ChargingVoltage()	63
12.1.26	0x32/33 ChargingCurrent()	63
12.1.27	0x3C/3D DesignCapacity()	63
12.1.28	0x3E/3F AltManufacturerAccess()	64
12.1.29	0x40/0x5F MACData()	64
12.1.30	0x60 MACDataChecksum()	64
12.1.31	0x61 MACDataLength()	64
12.2	0x00, 0x01 AltManufacturerAccess() and 0x3E, 0x3F AltManufacturerAccess()	64
12.2.1	AltManufacturerAccess() 0x0001 Device Type	66
12.2.2	AltManufacturerAccess() 0x0002 Firmware Version	66
12.2.3	AltManufacturerAccess() 0x0003 Hardware Version	66
12.2.4	AltManufacturerAccess() 0x0004 Instruction Flash Signature	67
12.2.5	AltManufacturerAccess() 0x0005 Static DF Signature	67
12.2.6	AltManufacturerAccess() 0x0006 Chemical ID	67
12.2.7	AltManufacturerAccess() 0x0007 Pre_MACWrite	67
12.2.8	AltManufacturerAccess() 0x0008 Static Chem DF Signature	67
12.2.9	AltManufacturerAccess() 0x0009 All DF Signature	67
12.2.10	AltManufacturerAccess() 0x0010 SHUTDOWN Mode	68
12.2.11	AltManufacturerAccess() 0x0011 SLEEP Mode	68

12.2.12	AltManufacturerAccess() 0x0012 Device Reset	68
12.2.13	AltManufacturerAccess() 0x001F CHG FET	68
12.2.14	AltManufacturerAccess() 0x0020 DSG FET	69
12.2.15	AltManufacturerAccess() 0x0021 Gauging	69
12.2.16	AltManufacturerAccess() 0x0022 FET Control.....	69
12.2.17	AltManufacturerAccess() 0x0023 Lifetime Data Collection.....	69
12.2.18	AltManufacturerAccess() 0x0024 Permanent Failure	69
12.2.19	AltManufacturerAccess() 0x0028 Lifetime Data Reset	70
12.2.20	AltManufacturerAccess() 0x0029 Permanent Fail Data Reset	70
12.2.21	AltManufacturerAccess() 0x002D CALIBRATION Mode	70
12.2.22	AltManufacturerAccess() 0x0030 Seal Device	70
12.2.23	AltManufacturerAccess() 0x0035 Security Keys.....	70
12.2.24	AltManufacturerAccess() 0x0037 Authentication Key.....	71
12.2.25	AltManufacturerAccess() 0x0041 Device Reset	71
12.2.26	AltManufacturerAccess() 0x0050 SafetyAlert	71
12.2.27	AltManufacturerAccess() 0x0051 SafetyStatus	72
12.2.28	AltManufacturerAccess() 0x0052 PFAlert	74
12.2.29	AltManufacturerAccess() 0x0053 PFStatus	74
12.2.30	AltManufacturerAccess() 0x0054 OperationStatus.....	75
12.2.31	AltManufacturerAccess() 0x0055 ChargingStatus.....	77
12.2.32	AltManufacturerAccess() 0x0056 GaugingStatus	78
12.2.33	AltManufacturerAccess() 0x0057 ManufacturingStatus	80
12.2.34	AltManufacturerAccess() 0x0058 AFE Register	81
12.2.35	AltManufacturerAccess() 0x0060 Lifetime Data Block 1.....	81
12.2.36	AltManufacturerAccess() 0x0070 ManufacturerInfo.....	81
12.2.37	AltManufacturerAccess() 0x0071 DAStatus1	82
12.2.38	AltManufacturerAccess() 0x0072 DAStatus2	82
12.2.39	AltManufacturerAccess() 0x0073 ITStatus1.....	82
12.2.40	AltManufacturerAccess() 0x0074 ITStatus2.....	83
12.2.41	AltManufacturerAccess() 0x0075 ITStatus3.....	83
12.2.42	AltManufacturerAccess() 0x0076 CB Status	84
12.2.43	AltManufacturerAccess() 0x0077 State-of-Health	84
12.2.44	AltManufacturerAccess() 0x0F00 ROM Mode	84
12.2.45	Data Flash Access() 0x4000–0x5FFF	84
12.2.46	AltManufacturerAccess() 0xF080 Exit Calibration Output Mode	85
12.2.47	AltManufacturerAccess() 0xF081 Output CC and ADC for Calibration.....	85
12.2.48	AltManufacturerAccess() 0xF082 Output Shorted CC and ADC for Calibration.....	86
13	Data Flash Values.....	87
13.1	Data Formats	87
13.1.1	Unsigned Integer	87
13.1.2	Integer	87
13.1.3	Floating Point	87
13.1.4	Hex.....	88
13.1.5	String.....	88
13.2	Calibration.....	88
13.2.1	Voltage.....	88
13.2.2	Current.....	88
13.2.3	Current Offset.....	88
13.2.4	Current Deadband	89
13.2.5	Temperature	89
13.2.6	Internal Temp Model.....	89
13.2.7	Cell Temp Model	89
13.3	Settings	90

13.3.1	Configuration.....	90
13.3.2	Charger	92
13.3.3	Protection.....	93
13.3.4	Permanent Failure	93
13.3.5	AFE	94
13.3.6	Manufacturing.....	94
13.4	Advanced Charging Algorithms	94
13.4.1	Temperature Ranges	94
13.4.2	Low Temp Charging	95
13.4.3	Standard Temp Charging	95
13.4.4	High Temp Charging.....	95
13.4.5	Rec Temp Charging	95
13.4.6	Pre-Charging.....	96
13.4.7	Maintenance Charging	96
13.4.8	Voltage Range.....	96
13.4.9	Termination Config.....	96
13.4.10	Cell Balancing Config	96
13.5	Power	97
13.5.1	Power	97
13.5.2	Shutdown.....	97
13.5.3	Sleep.....	97
13.5.4	Ship	97
13.6	Gas Gauging.....	98
13.6.1	Standby.....	98
13.6.2	Max Load.....	98
13.6.3	Current Thresholds.....	98
13.6.4	Design	98
13.6.5	Cycle	98
13.6.6	FD	99
13.6.7	FC	99
13.6.8	TDA	99
13.6.9	TCA	99
13.6.10	State	100
13.6.11	IT Config.....	100
13.6.12	Condition Flag	102
13.6.13	SOH.....	102
13.6.14	Max Error.....	102
13.7	System Data.....	102
13.7.1	Manufacturer Data.....	102
13.7.2	Integrity.....	103
13.8	Configuration	103
13.8.1	Data	103
13.9	Lifetimes	103
13.9.1	Voltage	103
13.9.2	Current	103
13.9.3	Temperature.....	103
13.10	Protections	104
13.10.1	CUV—Cell Undervoltage.....	104
13.10.2	COV—Cell Overvoltage	104
13.10.3	OCC—Overcurrent In Charge	104
13.10.4	OCD—Overcurrent In Discharge	104
13.10.5	AOLD—AFE Over Load In Discharge	105
13.10.6	ASCC—AFE Short Circuit in Charge	105

13.10.7	ASCD—AFE Short Circuit in Discharge	105
13.10.8	OTC—Overtemperature in Charge	105
13.10.9	OTD—Overtemperature in Discharge	105
13.10.10	UTC—Under Temperature in Charge.....	106
13.10.11	UTD—Under Temperature in Discharge	106
13.10.12	PTO—PRECHARGE Mode Time Out	106
13.10.13	CTO—FAST CHARGE Mode Time Out	106
13.11	Permanent Fail.....	106
13.11.1	SOV—Safety Cell Overvoltage.....	106
13.11.2	VIMR—Voltage Imbalance at Rest	107
13.11.3	VIMA—Voltage Imbalance Active	107
13.12	PF Status	107
13.12.1	Device Status	107
13.12.2	Device Voltage Data	109
13.12.3	Device Current Data	109
13.12.4	Device Temperature Data.....	109
13.12.5	Device Gauging Data	109
13.12.6	AFE Registers	110
13.13	RA Table.....	110
13.13.1	R_a0	110
13.13.2	R_a1	111
13.13.3	R_a0x	111
13.13.4	R_a1x	112
14	Data Flash Summary	113
14.1	Data Flash Table.....	113
A	AFE Threshold and Delay Settings.....	123
A.1	Overload in Discharge Protection (AOLD).....	123
A.2	Short Circuit in Charge (ASCC).....	124
A.3	Short Circuit in Discharge (ASCD1 and ASCD2).....	124
	Revision History	126

Preface

Read this First

This manual discusses the modules and peripherals of the BQ28Z610 device, and how each is used to build a complete battery pack gas gauge and protection solution. For BQ28Z610 electrical specifications, see the *BQ28Z610 Impedance Track™ Gas Gauge and Protection Solution for 1-Series to 2-Series Cell Li-Ion Battery Packs Data Sheet* ([SLUSAS3](#)).

Notational Conventions

The following notation is used if SBS commands and data flash (DF) values are mentioned within a text block:

- SBS commands: *italics* with parentheses and no breaking spaces; for example, *RemainingCapacity()*
- Data flash: *italics*, **bold**, and breaking spaces; for example, ***Design Capacity***
- Register bits and flags: *italics* and brackets; for example, *[TDA]*
- Data flash bits: *italics* and **bold**; for example, ***[LED1]***
- Modes and states: ALL CAPITALS; for example, UNSEALED

Trademarks

Impedance Track is a trademark of Texas Instruments.
All other trademarks are the property of their respective owners.

Glossary

[TI Glossary](#) — This glossary lists and explains terms, acronyms, and definitions.

Introduction

The BQ28Z610 device provides a feature-rich gas gauging solution for 1-series cell to 2-series cell battery-pack applications. The device has extended capabilities, including:

- Fully Integrated 1-Series to 2-Series Cell Li-Ion or Li-Polymer Cell Battery Pack Manager and Protection
- Next-Generation Patented Impedance Track™ Technology Accurately Measures Available Charge in Li-Ion and Li-Polymer Batteries
- High Side N-CH Protection FET Drive
- Integrated Cell Balancing While Charging or at Rest
- Power Modes
 - NORMAL Mode
 - SLEEP Mode
 - SHUTDOWN Mode
- Full Array of Programmable Protection Features
 - Voltage
 - Current
 - Temperature
 - Charge Timeout
 - CHG/DSG FETs
 - Cell Imbalance
 - BROADCAST Mode (available with the latest BQ28Z610 firmware from TI.com)
- Sophisticated Charge Algorithms
 - JEITA
 - Enhanced Charging
 - Adaptive Charging
 - Cell Balancing
- Diagnostic Lifetime Data Monitor
- Supports Two-Wire I²C Interface
- Battery Trip Point (BTP) Interrupts
- SHA-1 Authentication
- Ultra-Compact Package: 12-Lead SON

Protections

2.1 Introduction

This chapter describes the gauge's recoverable protection. When the protection is triggered, charging and/or discharging will be disabled. This is indicated by `OperationStatus()[XDSG] = 1` when discharging is disabled (DSG FET is turned OFF), and `OperationStatus()[XCHG] = 1` when charging is disabled (the CHG and PCHG FETs are turned OFF). Once the protection is recovered, charging and discharging resumes. All protection items can be enabled or disabled under **Settings:Enable Protections A** and **Settings:Enable Protections B**.

To protect the DSG FET body diode, the DSG FET will always be closed when `Current() > Charge Detect Current`, including when `OperationStatus()[XDSG] = 1`. Likewise, to protect the CHG FET body diode, the CHG FET will always be closed when `Current() ≤ Discharge Detect Current`, including when `OperationStatus()[XCHG] = 1`.

2.2 Cell Undervoltage Protection

The device can detect undervoltage in batteries and protect cells from damage by preventing further discharge.

Status	Condition	Action
Normal	Min cell voltages 1..2 > CUV:Threshold	<code>SafetyAlert()[CUV] = 0</code> <code>BatteryStatus()[TDA] = 0</code>
Alert	Min cell voltages 1..2 ≤ CUV:Threshold	<code>SafetyAlert()[CUV] = 1</code> <code>BatteryStatus()[TDA] = 1</code>
Trip	Min cell voltages 1..2 ≤ CUV:Threshold for CUV:Delay duration	<code>SafetyAlert()[CUV] = 0</code> <code>SafetyStatus()[CUV] = 1</code> <code>BatteryStatus()[FD] = 1, [TDA] = 0</code> <code>OperationStatus()[XDSG] = 1</code>
Recovery	Condition 1: <code>SafetyStatus()[CUV] = 1</code> AND Min cell voltages 1..2 ≥ CUV:Recovery AND Protection Configuration[CUV_RECOV_CHG] = 0 Condition 2: <code>SafetyStatus()[CUV] = 1</code> AND Min cell voltages 1..2 ≥ CUV:Recovery AND Protection Configuration[CUV_RECOV_CHG] = 1 AND [CUV_RECOV_CHG] = 1 AND Charging detected (that is, <code>BatteryStatus[DSG] = 0</code>)	<code>SafetyStatus()[CUV] = 0</code> <code>BatteryStatus()[FD] = 0, [TDA] = 0</code> <code>OperationStatus()[XDSG] = 1</code>

2.3 Cell Overvoltage Protection

The device can detect cell overvoltage in batteries and protect cells from damage by preventing further charging.

NOTE: The protection detection threshold may be influenced by the temperature settings of the advanced charging algorithm and the measured temperature.

Status	Condition	Action
Normal, <i>ChargingStatus()</i> [UT] or [LT] = 1	Max cell voltage 1..2 < COV:Threshold Low Temp	<i>SafetyAlert()</i> [COV] = 0
Normal, <i>ChargingStatus()</i> [STL] or [STH] = 1	Max cell voltage 1..2 < COV:Threshold Standard Temp	
Normal, <i>ChargingStatus()</i> [RT] = 1	Max cell voltage 1..2 < COV:Threshold Rec Temp	
Normal, <i>ChargingStatus()</i> [HT] or [OT] = 1	Max cell voltage 1..2 < COV:Threshold High Temp	
Alert, <i>ChargingStatus()</i> [UT] or [LT] = 1	Max cell voltage 1..2 ≥ COV:Threshold Low Temp	<i>SafetyAlert()</i> [COV] = 1 <i>BatteryStatus()</i> [TCA] = 1
Alert, <i>ChargingStatus()</i> [STL] or [STH] = 1	Max cell voltage 1..2 ≥ COV:Threshold Standard Temp	
Alert, <i>ChargingStatus()</i> [RT] = 1	Max cell voltage 1..2 ≥ COV:Threshold Rec Temp	
Alert, <i>ChargingStatus()</i> [HT] or [OT] = 1	Max cell voltage 1..2 ≥ COV:Threshold High Temp	
Trip, <i>ChargingStatus()</i> [UT] or [LT] = 1	Max cell voltage 1..2 ≥ COV:Threshold Low Temp for COV:Delay duration	<i>SafetyAlert()</i> [COV] = 0 <i>SafetyStatus()</i> [COV] = 1 <i>BatteryStatus()</i> [TCA] = 1 <i>OperationStatus()</i> [XCHG] = 1
Trip, <i>ChargingStatus()</i> [STL] or [STH] = 1	Max cell voltage 1..2 ≥ COV:Threshold Standard Temp for COV:Delay duration	
Trip, <i>ChargingStatus()</i> [RT] = 1	Max cell voltage 1..2 ≥ COV:Threshold Rec Temp for COV:Delay duration	
Trip, <i>ChargingStatus()</i> [HT] or [OT] = 1	Max cell voltage 1..2 ≥ COV:Threshold High Temp for COV:Delay duration	
Recovery, <i>ChargingStatus()</i> [UT] or [LT] = 1	<i>SafetyStatus()</i> [COV] = 1 AND Max cell voltage 1..2 ≤ COV:Recovery Low Temp	<i>SafetyStatus()</i> [COV] = 0 <i>BatteryStatus()</i> [TCA] = 0 <i>OperationStatus()</i> [XCHG] = 0
Recovery, <i>ChargingStatus()</i> [STL] or [STH] = 1	<i>SafetyStatus()</i> [COV] = 1 AND Max cell voltage 1..2 ≤ COV:Recovery Standard Temp	
Recovery, <i>ChargingStatus()</i> [RT] = 1	<i>SafetyStatus()</i> [COV] = 1 AND Max cell voltage 1..2 ≤ COV:Recovery Rec Temp	
Recovery, <i>ChargingStatus()</i> [HT] or [OT] = 1	<i>SafetyStatus()</i> [COV] = 1 AND Max cell voltage 1..2 ≤ COV:Recovery High Temp	

2.4 Overcurrent in Charge Protection

To protect cells from damage due to unsafe charge currents, the device can detect overcurrent events and disable the appropriate FET.

Status	Condition	Action
Normal	<i>Current()</i> < OCC:Threshold	<i>SafetyAlert()</i> [OCC] = 0
Alert	<i>Current()</i> ≥ OCC:Threshold	<i>SafetyAlert()</i> [OCC] = 1
Trip	<i>Current()</i> continuous ≥ OCC:Threshold for OCC:Delay duration	<i>SafetyAlert()</i> [OCC1] = 0 <i>SafetyStatus()</i> [OCC] = 1 <i>BatteryStatus()</i> [TCA] = 1 <i>OperationStatus()</i> [XCHG] = 1
Recovery	[<i>SafetyStatus()</i> [OCC] = 1 AND <i>Current()</i> continuous ≤ OCC:Recovery Threshold for OCC:Recovery Delay time	<i>SafetyStatus()</i> [OCC] = 0 <i>BatteryStatus()</i> [TCA] = 0 <i>OperationStatus()</i> [XCHG] = 0

2.5 Overcurrent in Discharge Protection

To protect cells from damage due to unsafe load currents, the device can detect overcurrent events and disable the appropriate FET.

Status	Condition	Action
Normal	$Current() > \mathbf{OCD:Threshold}$	$SafetyAlert()[OCD] = 0$
Alert	$Current() \leq \mathbf{OCD:Threshold}$	$SafetyAlert()[OCD] = 1$
Trip	$Current()$ continuous $\leq \mathbf{OCD:Threshold}$ for $\mathbf{OCD:Delay}$ duration	$SafetyAlert()[OCD1] = 0$ $SafetyStatus()[OCD] = 1$ $BatteryStatus()[TDA] = 0$ $OperationStatus()[XDSDG] = 1$
Recovery	$[SafetyStatus()[OCD] = 1 \text{ AND } Current() \text{ continuous} \geq \mathbf{OCD:Recovery Threshold}$ for $\mathbf{OCD:Recovery Delay}$ time	$SafetyStatus()[OCD] = 0$ $BatteryStatus()[TDA] = 0$ $OperationStatus()[XDSDG] = 0$

2.6 Hardware-Based Protection

The BQ28Z610 device has three main hardware-based protections—AOLD, ASCC, and ASCD1,2—with adjustable current and delay time. Setting **AFE Protection Configuration[RSNS]** divides the threshold value in half. The **Threshold** settings are in mV; therefore, the actual current that triggers the protection is based on the R_{SENSE} used in the schematic design (see the *BQ28Z610 1-Cell to 2-Series Cell Li-Ion Battery Pack Manager Data Sheet [SLUSAS3]*).

In addition, setting the **AFE Protection Configuration[SCDDx2]** bit provides an option to double all of the SCD1,2 delay times for maximum flexibility towards the application's needs.

For details on how to configure the AFE hardware protection, refer to the tables in [Appendix A](#).

All of the hardware-based protections provide a short term Trip/Recovery protection to account for a current spike. The fault protection detects current spikes and after a delay time will turn OFF both FETs. Then with a delay up to 250 ms, the non-appropriate FET associated with the fault condition will turn back ON. The recovery method is a timer-based recovery set in **Protections**.

Generally, when a fault is detected after the **Delay** time, both CHG and DSG FETs will be disabled (Trip stage). Since both FETs are off, the current will drop to 0 mA. After **Recovery** time, the CHG FET or DSG FET will be turned on again (Recovery stage) based on the fault condition.

The Trip/Recovery are documented in each of the following hardware-based protection sections.

NOTE: There is no **PRES** pin on the BQ28Z610 device.

2.6.1 Overload in Discharge Protection

The device has a hardware-based overload in discharge protection with adjustable current and delay.

Status	Condition	Action
Normal	$Current() > (\mathbf{AOLD Threshold}[3:0]/R_{SENSE})$	$SafetyAlert()[AOLD] = 0$
Trip	$Current()$ continuous $\leq (\mathbf{AOLD Threshold}[3:0]/R_{SENSE})$ for $\mathbf{AOLD Threshold}[7:4]$ duration	$SafetyStatus()[AOLD] = 1$ $OperationStatus()[XDSDG] = 1$
Recovery	$SafetyStatus()[AOLD] = 1$ for $\mathbf{OLD:Recovery}$ time	$SafetyStatus()[AOLD] = 0$ $OperationStatus()[XDSDG] = 0$

2.6.2 Short Circuit in Charge Protection

The device has a hardware-based short circuit in charge protection with adjustable current and delay.

Status	Condition	Action
Normal	$Current() > (ASCC\ Threshold[2:0]/R_{SENSE})$	$SafetyAlert()[ASCC] = 0$
Trip	$Current()$ continuous $\leq (ASCC\ Threshold[2:0]/R_{SENSE})$ for ASCC Threshold[7:4] duration	$SafetyStatus()[ASCC] = 1$ $BatteryStatus()[TCA] = 1$ $OperationStatus()[XCHG] = 1$
Recovery	$SafetyStatus()[ASCC] = 1$ for SCC:Recovery time	$SafetyStatus()[ASCC] = 0$ $BatteryStatus()[TCA] = 1$ $OperationStatus()[XCHG] = 0$

2.6.3 Short Circuit in Discharge Protection

The device has a hardware-based short circuit in discharge protection with adjustable current and delay.

Status	Condition	Action
Normal	$Current() > (ASCD1\ Threshold[2:0]/R_{SENSE})$ AND $Current() > (ASCD2\ Threshold[2:0]/R_{SENSE})$	$SafetyAlert()[ASCD] = 0$
Trip	$Current()$ continuous $\leq (ASCD1\ Threshold[2:0]/R_{SENSE})$ for SCD1Threshold[7:4] duration OR $Current()$ continuous $\leq (ASCD2\ Threshold[2:0]/R_{SENSE})$ for ASCD2Threshold[7:4] duration	$SafetyStatus()[ASCD] = 1$ $OperationStatus()[XDSDG] = 1$
Recovery	$SafetyStatus()[ASCD] = 1$ for SCD:Recovery time	$SafetyStatus()[ASCD] = 0$ $OperationStatus()[XDSDG] = 0$

2.7 Temperature Protections

The device provides overtemperature and undertemperature protections based on Cell Temperature measurement. The Cell Temperature based protections are further divided into a protection-in-charging direction and discharging direction. This section describes in detail each of the protection functions.

For temperature reporting, the device supports a maximum of one external thermistors and one internal temperature sensor. Unused temperature sensors must be disabled by clearing the corresponding flag in **Settings:Temperature Enable[TS1][TSInt]**.

The **Settings:DA Configuration[CTEMP]** allows users to use the maximal (**[CTEMP] = 0**) or the average (**[CTEMP] = 1**) of the source temperature sensors for Cell Temperature reporting.

The *Temperature()* command returns the Cell Temperature measurement. The MAC and extended command *DAStatus2()* also returns the temperature measurement from the internal temperature sensor, the external thermistors TS1, and the Cell Temperatures.

The Cell Temperature based overtemperature and undertemperature safety provide protections in charge and discharge conditions. The battery pack is in CHARGE mode when $BatteryStatus()[DSG] = 0$, where $Current() > Chg\ Current\ Threshold$. The overtemperature and undertemperature in charging protections are active in this mode. The $BatteryStatus()[DSG]$ is set to 1 in a NON-CHARGE mode condition, which includes RELAX and DISCHARGE modes. The overtemperature and undertemperature in discharge protections are active in these two modes. See [Section 6.3](#) for detailed descriptions of the gas gauge modes.

2.8 Overtemperature in Charge Protection

The device has an overtemperature protection for cells charging.

Status	Condition	Action
Normal	$Temperatures() < OTC:Threshold$ OR not charging	$SafetyAlert()[OTC] = 0$
Alert	$Temperatures() \geq OTC:Threshold$ AND charging	$SafetyAlert()[OTC] = 1$ $BatteryStatus()[TCA] = 1$

Status	Condition	Action
Trip	$Temperatures() \geq \text{OTC:Threshold}$ AND charging for OTC:Delay duration	$SafetyAlert()[OTC] = 0$ $SafetyStatus()[OTC] = 1$ $BatteryStatus()[OTA] = 1$ $BatteryStatus()[TCA] = 0$ $OperationStatus()[XCHG] = 1$
Recovery	$SafetyStatus()[OTC]$ AND Cell Temperature in $Temperatures() \leq \text{OTC:Recovery}$	$SafetyStatus()[OTC] = 0$ $BatteryStatus()[OTA] = 0$ $BatteryStatus()[TCA] = 0$ $OperationStatus()[XCHG] = 0$

2.9 Overtemperature in Discharge Protection

The device has an overtemperature protection for cells in DISCHARGE or RELAX state (that is, non-charging state with $BatteryStatus[DSG] = 1$).

Status	Condition	Action
Normal	$Temperatures() < \text{OTD:Threshold}$ OR charging	$SafetyAlert()[OTD] = 0$
Alert	$Temperatures() \geq \text{OTD:Threshold}$ AND not charging (that is, $BatteryStatus[DSG] = 1$)	$SafetyAlert()[OTD] = 1$ $BatteryStatus()[TDA] = 1$
Trip	Cell Temperature in $Temperatures() \geq \text{OTD:Threshold}$ AND not charging (that is, $BatteryStatus[DSG] = 1$) for OTD:Delay duration	$SafetyAlert()[OTD] = 0$ $SafetyStatus()[OTD] = 1$ $BatteryStatus()[OTA] = 1$ $OperationStatus()[XDSG] = 1$ $BatteryStatus()[TDA] = 0$
Recovery	$SafetyStatus()[OTD]$ AND Cell Temperature in $Temperatures() \leq \text{OTD:Recovery}$	$SafetyStatus()[OTD] = 0$ $BatteryStatus()[OTA] = 0$ $OperationStatus()[XDSG] = 0$ $BatteryStatus()[TDA] = 0$

2.10 Undertemperature in Charge Protection

The device has an undertemperature protection for cells in charge direction.

Status	Condition	Action
Normal	$Temperatures() > \text{UTC:Threshold}$ OR not charging	$SafetyAlert()[UTC] = 0$
Alert	$Temperatures() \leq \text{UTC:Threshold}$ AND charging	$SafetyAlert()[UTC] = 1$
Trip	$Temperatures() \leq \text{UTC:Threshold}$ AND charging for UTC:Delay duration	$SafetyAlert()[UTC] = 0$ $SafetyStatus()[UTC] = 1$ $OperationStatus()[XCHG] = 1$
Recovery	$SafetyStatus()[UTC]$ AND $Temperatures() \geq \text{UTC:Recovery}$	$SafetyStatus()[UTC] = 0$ $OperationStatus()[XCHG] = 0$

2.11 Undertemperature in Discharge Protection

The device has an undertemperature protection for cells in DISCHARGE or RELAX state (that is, non-charging state with $BatteryStatus[DSG] = 1$).

Status	Condition	Action
Normal	$Temperatures() > \text{UTD:Threshold}$ OR charging	$SafetyAlert()[UTD] = 0$
Alert	$Temperatures() \leq \text{UTD:Threshold}$ AND not charging (that is, $BatteryStatus[DSG] = 1$)	$SafetyAlert()[UTD] = 1$
Trip	$Temperatures() \leq \text{UTD:Threshold}$ AND not charging (that is, $BatteryStatus[DSG] = 1$) for UTD:Delay duration	$SafetyAlert()[UTD] = 0$ $SafetyStatus()[UTD] = 1$ $OperationStatus()[XDSG] = 1$
Recovery	$SafetyStatus()[UTD]$ AND $Temperatures() \geq \text{UTD:Recovery}$	$SafetyStatus()[UTD] = 0$ $BatteryStatus()[OTA] = 0$ $OperationStatus()[XDSG] = 0$

2.12 Precharge Timeout Protection

The device can measure the precharge time and stop charging if it exceeds the adjustable period.

Status	Condition	Action
Enable	$Current() > \mathbf{PTO:Charge\ Threshold}$ AND $ChargingStatus()[PV] = 1$	Start PTO timer $SafetyAlert()[PTOS] = 0$
Suspend or Recovery	$Current() < \mathbf{PTO:Suspend\ Threshold}$	Stop PTO timer $SafetyAlert()[PTOS] = 1$
Trip	$PTO\ timer > \mathbf{PTO:Delay}$	Stop PTO timer $SafetyStatus()[PTO] = 1$ $OperationStatus()[XCHG] = 1$
Reset	$SafetyStatus()[PTO] = 1$ AND (Discharge by an amount of PTO:Reset)	Stop and reset PTO timer $SafetyAlert()[PTOS] = 0$ $SafetyStatus()[PTO] = 0$ $BatteryStatus()[TCA] = 0$ $OperationStatus()[XCHG] = 0$

2.13 Fast Charge Timeout Protection

The device can measure the charge time, and stop charging if it exceeds the adjustable period.

Status	Condition	Action
Enable	$Current() > \mathbf{CTO:Charge\ Threshold}$ AND ($ChargingStatus()[LV] = 1$ OR $ChargingStatus()[MV] = 1$ OR $ChargingStatus()[HV] = 1$)	Start CTO timer $SafetyAlert()[CTOS] = 0$
Suspend or Recovery	$Current() < \mathbf{CTO:Suspend\ Threshold}$	Stop CTO timer $SafetyAlert()[CTOS] = 1$
Trip	$CTO\ time > \mathbf{CTO:Delay}$	Stop CTO timer $SafetyStatus()[CTO] = 1$ $BatteryStatus()[TCA] = 1$ $OperationStatus()[XCHG] = 1$
Reset	$SafetyStatus()[CTO] = 1$ AND (Discharge by an amount of CTO:Reset)	Stop and reset CTO timer $SafetyAlert()[CTOS] = 0$ $SafetyStatus()[CTO] = 0$ $BatteryStatus()[TCA] = 0$ $OperationStatus()[XCHG] = 0$

Permanent Fail

3.1 Introduction

The device can permanently disable the battery pack in the case of a severe failure, such as an error in the instruction flash check (IFC) or in the data flash write (DFW). An IFC failure is set by the gauge if the signature fails to pass verification at power-on reset. The DFW failure is set by the gauge if it is unable to successfully program an update to the data flash (the read-back verification fails). When one of these failure modes is detected, the following actions are taken in sequence:

1. Charge and discharge FETs are turned off.
2. $OperationStatus()[PF] = 1$
3. The following data is changed: $BatteryStatus()[TCA] = 1$, $BatteryStatus()[TDA] = 1$, $ChargingCurrent() = 0$, and $ChargingVoltage() = 0$.
4. A backup of the internal AFE hardware registers are written to data flash: **AFE Interrupt Status, AFE FET Status, AFE RXIN, AFE Latch Status, AFE Interrupt Enable, AFE FET Control, AFE RXIEN, AFE Cell Balance, AFE AD/CC Control, AFE ADC Mux, AFE State Control, Wake Control, AFE Protection Control, AFE OCD, AFE SCC, AFE SCD1, and AFE SCD2.**
5. The following values are preserved in data flash for failure analysis:
 - $SafetyAlert()$
 - $SafetyStatus()$
 - $OperationStatus()$
 - $ChargingStatus()$
 - $GaugingStatus()$
 - Voltages in $DAStatus1()$
 - $Current()$
 - TSINT, TS1, from $DAStatus2()$
 - Cell DOD0 and passed charge
6. Data flash writing is disabled.

While the device is in this PERMANENT FAIL mode, any new $SafetyAlert()$, $SafetyStatus()$ flags that are set are added to the permanent fail log.

3.2 Safety Cell Overvoltage Permanent Fail

The device can permanently disable the battery in the case of severe overvoltage in any of the cells.

Status	Condition	Action
Normal	All Cell voltages in $DAStatus1() < SOV:Threshold$	$PFAAlert()[SOV] = 0$
Alert	Any Cell voltages in $DAStatus1() \geq SOV:Threshold$	$PFAAlert()[SOV] = 1$ $BatteryStatus()[TCA] = 1$ $BatteryStatus()[OCA] = 1$
Trip	Any Cell voltages in $DAStatus1()$ continuous $\geq SOV:Threshold$ for $SOV:Delay$ duration	$PFAAlert()[SOV] = 0$ $PFStatus()[SOV] = 1$ $BatteryStatus()[OCA] = 1$ $BatteryStatus()[TCA] = 1$ $BatteryStatus()[TDA] = 1$

3.3 Voltage Imbalance at Rest Permanent Fail

The device can permanently disable the battery pack in case of a voltage difference between the cells in a stack while at rest.

Status	Condition	Action
Normal	$CellVoltage0..1() < VIMR:Check\ Voltage$ OR $ Current() > VIMR:Check\ Current$ OR $\Delta(CellVoltage0..1()) < VIMR:Delta\ Threshold$	$PFAlert()[VIMR] = 0$
Alert	$Any(CellVoltage0..1()) \geq VIMR:Check\ Voltage$ AND $ Current() < VIMR:Check\ Current$ for $VIMR:Duration$ AND $\Delta(CellVoltage0..1()) \geq VIMR:Delta\ Threshold$	$PFAlert()[VIMR] = 1$
Trip	$Any(CellVoltage0..1()) \geq VIMR:Check\ Voltage$ AND $ Current() < VIMR:Check\ Current$ for $VIMR:Duration$ AND $\Delta(CellVoltage0..1()) \geq VIMR:Delta\ Threshold$ for $VIMR:Delta\ Delay$	$PFAlert()[VIMR] = 0$ $PFStatus()[VIMR] = 1$ $BatteryStatus()[TCA] = 1$ $BatteryStatus()[TDA] = 1$

3.4 Voltage Imbalance Active Permanent Fail

The device can permanently disable the battery pack in case of a voltage difference between the cells in a stack while active.

Status	Condition	Action
Normal	$CellVoltage0..13() < VIMA:Check\ Voltage$ OR $ Current() > VIMA:Check\ Current$ OR $\Delta(CellVoltage0..1()) < VIMA:Delta\ Threshold$	$PFAlert()[VIMA] = 0$
Alert	$Any(CellVoltage0..1()) \geq VIMA:Check\ Voltage$ AND $ Current() < VIMA:Check\ Current$ for $VIMA:Duration$ AND $\Delta(CellVoltage0..1()) \geq VIMA:Delta\ Threshold$	$PFAlert()[VIMA] = 1$
Trip	$Any(CellVoltage0..1()) \geq VIMA:Check\ Voltage$ AND $ Current() < VIMA:Check\ Current$ for $VIMA:Duration$ AND $\Delta(CellVoltage0..1()) \geq VIMA:Delta\ Threshold$ for $VIMA:Delay$	$PFAlert()[VIMA] = 0$ $PFStatus()[VIMA] = 1$ $BatteryStatus()[TCA] = 1$ $BatteryStatus()[TDA] = 1$

3.5 Charge FET Permanent Failure

3.5.1 Description

The device will enter PERMANENT FAILURE mode in case the charge (CHG) FET is not working properly.

Status	Condition	Action
Normal	CHG FET off AND $Current() < CFET:OFF\ Threshold$	$PFAlert()[CFETF] = 0$
Alert	CHG FET off AND $Current() \geq CFET:OFF\ Threshold$	$PFAlert()[CFETF] = 1$
Trip	CHG FET off AND $Current()$ continuously $\geq CFET:OFF\ Threshold$ for $CFET:OFF\ Delay$ duration	$PFAlert()[CFETF] = 0$ $PFStatus()[CFETF] = 1$

Table 3-1. CFET Data Flash Configuration

Class	Subclass	Name	Type	Min Value	Max Value	Default Value	Unit
Permanent Fail	CFET	OFF Threshold	I2	0	500	5	mA
Permanent Fail	CFET	Delay	U1	0	255	5	s

3.5.2 Feature Enable/Disable

The feature is enabled when **CFETF** is set in **Enable PF C**.

3.6 Discharge FET Permanent Failure

3.6.1 Description

The device will enter PERMANENT FAILURE mode in case the discharge (DSG) FET is not working properly.

Status	Condition	Action
Normal	DSG FET off AND $Current() > DFET:OFF\ Threshold$	$PFAAlert()[DFETF] = 0$
Alert	DSG FET off AND $Current() \leq DFET:OFF\ Threshold$	$PFAAlert()[DFETF] = 1$
Trip	DSG FET off AND $Current()$ continuously $\leq DFET:OFF\ Threshold$ for DFET:OFF Delay duration	$PFAAlert()[DFETF] = 0$ $PFStatus()[DFETF] = 1$

Table 3-2. DFET Data Flash Configuration

Class	Subclass	Name	Type	Min Value	Max Value	Default Value	Unit
Permanent Fail	DFET	OFF Threshold	I2	-500	0	-5	mA
Permanent Fail	DFET	Delay	U1	0	255	5	s

3.6.2 Feature Enable/Disable

The feature is enabled when **DFETF** is set in **Enable PF C**.

3.7 Instruction Flash (IF) Checksum Permanent Fail

The device can permanently disable the battery if it detects a difference between the stored IF checksum and the calculated IF checksum only following a device reset.

Status	Condition	Action
Normal	Stored and calculated IF checksum match	—
Trip	Stored and calculated IF checksum after reset does not match.	$PFStatus()[IFC] = 1$ $BatteryStatus()[TCA] = 1$ $BatteryStatus()[TDA] = 1$

3.8 Data Flash (DF) Permanent Fail

The device can permanently disable the battery in case a data flash write fails.

NOTE: A DF write failure causes the gauge to disable further DF writes.

Status	Condition	Action
Normal	Data flash write ok	—
Trip	Data flash write not successful	$PFStatus()[DFW] = 1$ $BatteryStatus()[TCA] = 1$ $BatteryStatus()[TDA] = 1$

Advanced Charge Algorithm

4.1 Introduction

The device can change the values of *ChargingVoltage()* and *ChargingCurrent()* based on *Temperature()* and *Cell Voltage1..2()*. Its flexible charging algorithm is JEITA-compatible and can also meet other specific cell manufacturer charge requirements. The *ChargingStatus()* register shows the state of the charging algorithm.

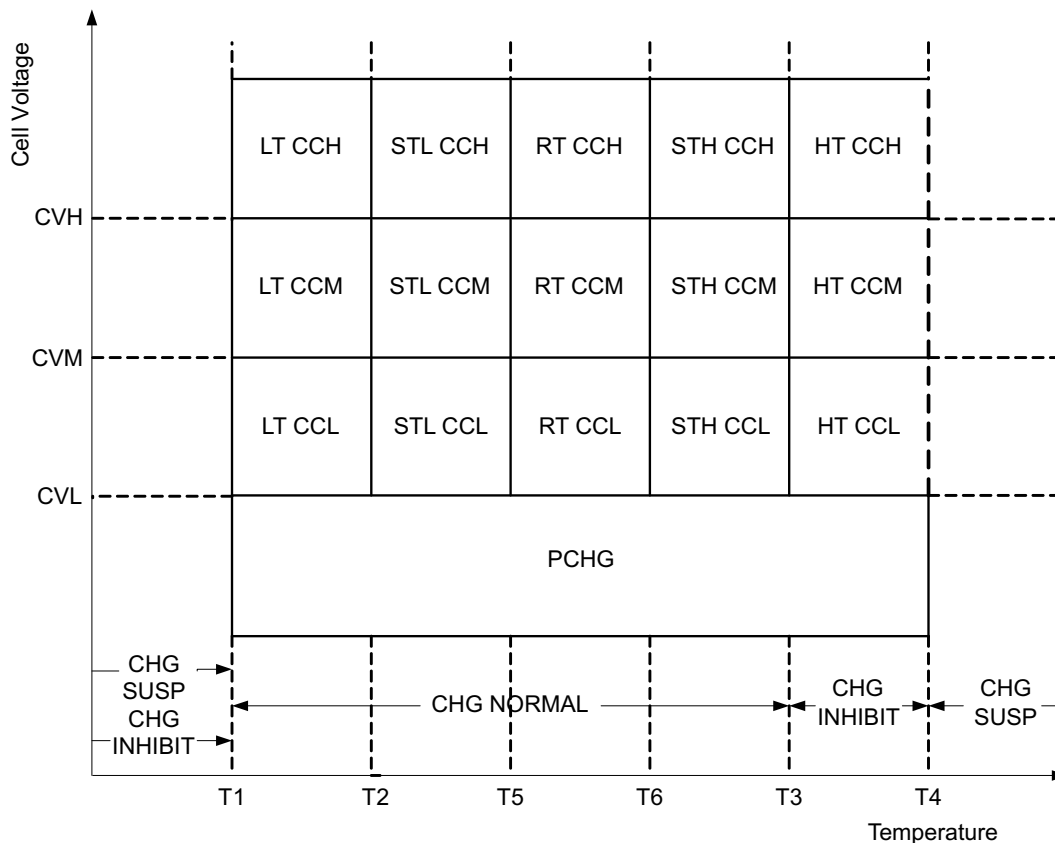

4.2 Charge Temperature Ranges

The measured temperature is segmented into several temperature ranges. The charging algorithm adjusts *ChargingCurrent()* and *ChargingVoltage()* according to the temperature range. The temperature ranges set in data flash should adhere to the following format:

$$T1 \leq T2 \leq T5 \leq T6 \leq T3 \leq T4$$

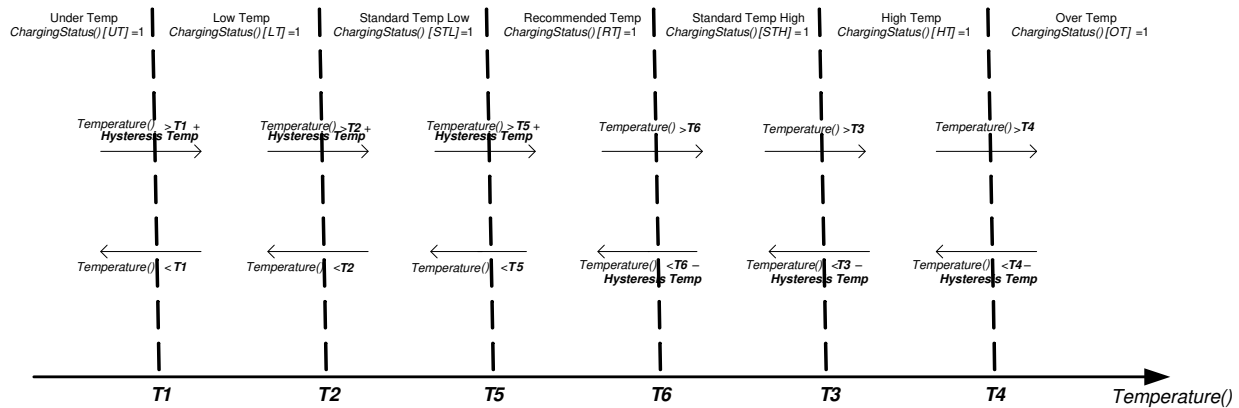

4.3 Voltage Range

The measured cell voltage is segmented into several voltage ranges. The charging algorithm adjusts *ChargingCurrent()* according to the temperature range and voltage range. The voltage ranges set in data flash should adhere to the following format:

$$Charging\ Voltage\ Low \leq Charging\ Voltage\ Med \leq Charging\ Voltage\ High \leq x\ Temp\ Charging:Voltage$$

where x is Standard or Rec. Depending on the specific charging profile, the **Low Temp Charging:Voltage** and **High Temp Charging:Voltage** settings do not necessarily have the highest setting values.

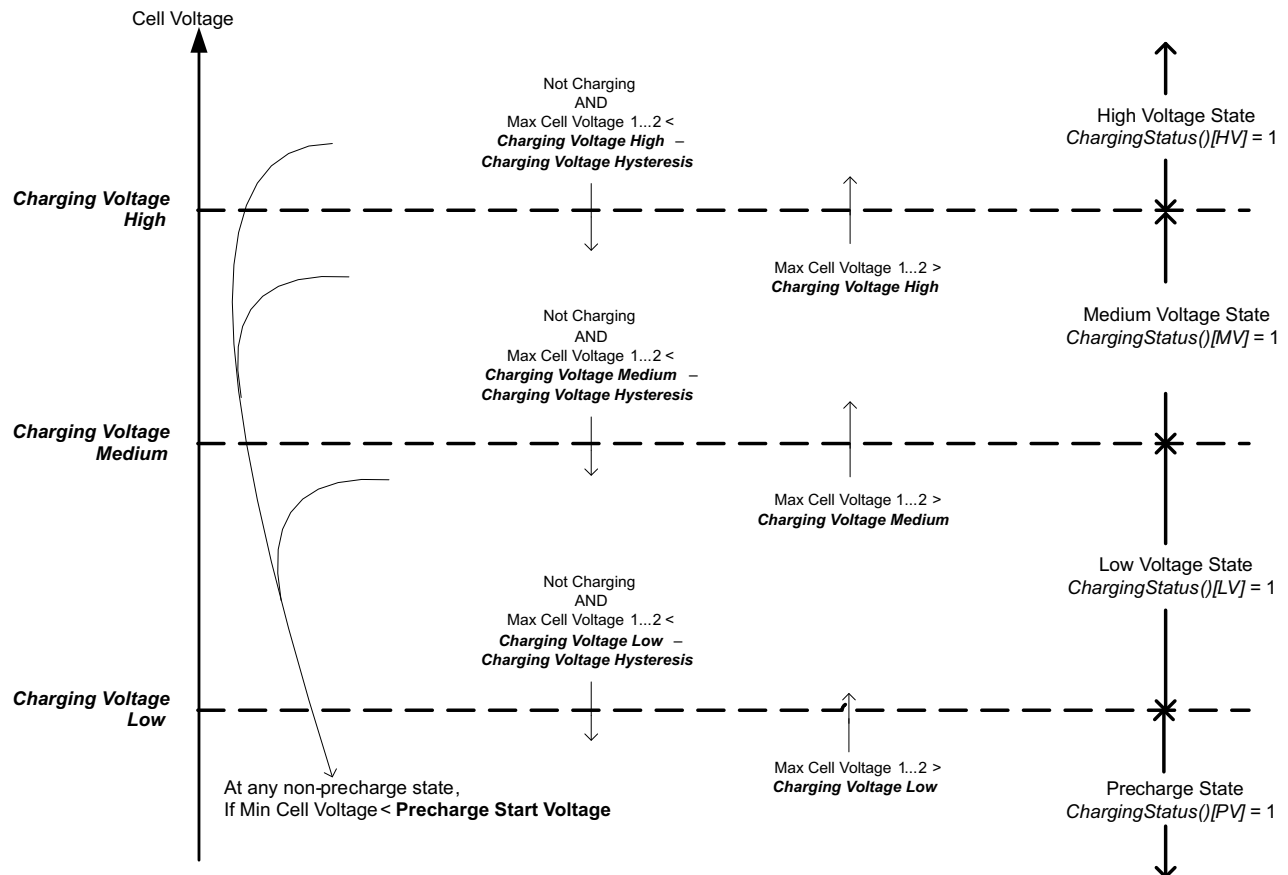

4.4 Charging Current

The *ChargingCurrent()* value changes depending on the detected temperature and voltage per the charging algorithm.

The **Charging Configuration[CRATE]** flag provides an option to adjust the *ChargingCurrent()* based on *FullChargeCapacity()/DesignCapacity()*.

For example, with **[CRATE] = 1**, if *FullChargeCapacity()/DesignCapacity()* = 90% and **Rec Temp Charging: Current Med** is active per the charging algorithm, the *ChargeCurrent()* = **Rec Temp Charging: Current Med** × 90%.

NOTE: Table priority is top to bottom.

Temp Range	Voltage Range	Condition	Action
Any	Any	<i>OperationStatus()[XCHG] = 1</i>	<i>ChargingCurrent() = 0</i>
UT or OT	Any	—	<i>ChargingCurrent() = 0</i>
Any	PV	—	<i>ChargingCurrent() = Pre-Charging:Current</i>
Any	LV, MV, or HV	<i>ChargingStatus()[MCHG] = 1</i>	<i>ChargingCurrent() = Maintenance Charging:Current</i>
LT	LV	—	<i>ChargingCurrent() = Low Temp Charging:Current Low</i>
	MV	—	<i>ChargingCurrent() = Low Temp Charging:Current Med</i>
	HV	—	<i>ChargingCurrent() = Low Temp Charging:Current High</i>
STL or STH	LV	—	<i>ChargingCurrent() = Standard Temp Charging:Current Low</i>
	MV	—	<i>ChargingCurrent() = Standard Temp Charging:Current Med</i>
	HV	—	<i>ChargingCurrent() = Standard Temp Charging:Current High</i>
RT	LV	—	<i>ChargingCurrent() = Rec Temp Charging:Current Low</i>
	MV	—	<i>ChargingCurrent() = Rec Temp Charging:Current Med</i>
	HV	—	<i>ChargingCurrent() = Rec Temp Charging:Current High</i>
HT	LV	—	<i>ChargingCurrent() = High Temp Charging:Current Low</i>
	MV	—	<i>ChargingCurrent() = High Temp Charging:Current Med</i>
	HV	—	<i>ChargingCurrent() = High Temp Charging:Current High</i>

4.5 Charging Voltage

The *ChargingVoltage()* changes depending on the detected temperature per the charge algorithm.

NOTE: Table priority is top to bottom.

Temp Range	Condition	Action
Any	<i>OperationStatus()[XCHG] = 1</i>	<i>ChargingVoltage() = 0</i>
UT or OT	—	<i>ChargingVoltage() = 0</i>
LT	—	<i>ChargingVoltage() = Low Temp Charging:Voltage × (DA Configuration[CC1:CC0] + 1)</i>
STL or STH	—	<i>ChargingVoltage() = Standard Temp Charging:Voltage × (DA Configuration[CC1:CC0] + 1)</i>
RT	—	<i>ChargingVoltage() = Rec Temp Charging:Voltage × (DA Configuration[CC1:CC0] + 1)</i>
HT	—	<i>ChargingVoltage() = High Temp Charging:Voltage × (DA Configuration[CC1:CC0] + 1)</i>

4.6 Valid Charge Termination

The charge termination condition must be met to enable valid charge termination. The device has the following actions at charge termination, based on the flags settings:

- If **FET Options[CHGFET]** = 1 and **GaugingStatus()[TC]** = 1, CHG FET turns off.
- If **Gauging Configuration[CSYNC]** = 1, **RemainingCapacity()** = **FullChargeCapacity()**.
- If **Gauging Configuration[RSOCL]** = 1, **RelativeStateOfCharge()** and **RemainingCapacity()** are held at 99% until charge termination occurs. Only on entering charge termination is 100% displayed.
- If **Gauging Configuration[RSOCL]** = 0, **RelativeStateOfCharge()** and **RemainingCapacity()** are not held at 99% until charge termination occurs. Fractions of % greater than 99% are rounded up to display 100%.

Status	Condition	Action
Charging	GaugingStatus()[REST] = 0 AND GaugingStatus()[DSG] = 0	Charge Algorithm active
Valid Charge Termination	All of the following conditions must occur for two consecutive 40-s periods: Charging (that is, BatteryStatus[DSG] = 0) AND AverageCurrent() < Charge Term Taper Current AND Max (CellVoltage2...1) + Charge Term Voltage ≥ ChargingVoltage()/number of cells in series AND The accumulated change in capacity > 0.25 mAh	ChargingStatus()[VCT] = 1 ChargingStatus()[MCHG] = 1 ChargingVoltage() = Charging Algorithm ChargingCurrent() = Charging Algorithm BatteryStatus()[FC] = 1 and GaugingStatus()[FC] = 1 if SOCFlagConfig A[FCSETVCT] = 1 BatteryStatus()[TCA] = 1 and GaugingStatus()[TCA] = 1 if SOCFlagConfig B[TCASETVCT] = 1

4.7 Charge and Discharge Alarms

The **[TC]** and **[FC]** bits in **GaugingStatus()** can be set at charge termination and based on RSOC or cell voltages. If multiple set and clear conditions are selected, then the corresponding flag is set whenever a valid set or clear condition is met. If the set and clear conditions are true at the same time, the flag will clear. The same functionality is applied to the **[TD]** and **[FD]** bits in **GaugingStatus()**.

NOTE: **GaugingStatus[TC][TD][FC][FD]** are the status flags based on the gauging conditions only. These flags are set and cleared based on **SOCFlagConfigA** and **SOCFlagConfigB**.

The **BatteryStatus[TCA][TDA][FC][FD]** flags will be set and cleared according to the **GaugingStatus[TC][TD][FC][FD]** flags, as well as the safety and permanent failure protections status.

The table below summarizes the options to set and clear the **[TC]** and **[FC]** flags in **GaugingStatus()**.

Flag	Set Criteria	Set Condition	Enable
[TC]	Cell Voltage	Max cell voltage1..2 ≥ TC: Set Voltage Threshold	SOCFlagConfigA[TCSetV] = 1
	RSOC	RelativeStateOfCharge() > = TC: Set % RSOC Threshold	SOCFlagConfigA[TCSetRSOC] = 1
	Valid Charge Termination (enable by default)	When ChargingStatus[VCT] = 1	SOCFlagConfigA[TCSetVCT] = 1
[FC]	Cell Voltage	Max cell voltage1..2 ≥ FC: Set Voltage Threshold	SOCFlagConfigB[FCSetV] = 1
	RSOC	RelativeStateOfCharge() > = FC: Set % RSOC Threshold	SOCFlagConfigB[FCSetRSOC] = 1
	Valid Charge Termination (enable by default)	When ChargingStatus[VCT] = 1	SOCFlagConfigA[FCSetVCT] = 1

Flag	Clear Criteria	Clear Condition	Enable
[TC]	Cell Voltage	Max cell voltage _{1..2} ≤ TC: Clear Voltage Threshold	SOCFlagConfigA[TCClearV] = 1
	RSOC (enable by default)	<i>RelativeStateOfCharge()</i> ≤ TC: Clear % RSOC Threshold	SOCFlagConfigA[TCClearRSOC] = 1
[FC]	Cell Voltage	Max cell voltage _{1..2} ≤ FC: Clear Voltage Threshold	SOCFlagConfigB[FCClearV] = 1
	RSOC (enable by default)	<i>RelativeStateOfCharge()</i> ≤ FC: Clear % RSOC Threshold	SOCFlagConfigB[FCClearRSOC] = 1

The tables below summarize the various options to set and clear the [TD] and [FD] flags in both *BatteryStatus()* and *GaugingStatus()*.

Flag	Set Criteria	Set Condition	Enable
[TD]	Cell Voltage	Max cell voltage _{1..2} ≤ TD: Set Voltage Threshold	SOCFlagConfigA[TDSetV] = 1
	RSOC (enable by default)	<i>RelativeStateOfCharge()</i> ≤ TD: Set % RSOC Threshold	SOCFlagConfigA[TDSetRSOC] = 1
[FD]	Cell Voltage	Max cell voltage _{1..2} ≤ FD: Set Voltage Threshold	SOCFlagConfigB[FDSetV] = 1
	RSOC (enable by default)	<i>RelativeStateOfCharge()</i> ≤ FD: Set % RSOC Threshold	SOCFlagConfigB[FDSetRSOC] = 1

Flag	Clear Criteria	Clear Condition	Enable
[TD]	Cell Voltage	Max cell voltage _{1..2} ≥ TD: Clear Voltage Threshold	SOCFlagConfigA[TDClearV] = 1
	RSOC (enable by default)	<i>RelativeStateOfCharge()</i> ≥ TD: Clear % RSOC Threshold	SOCFlagConfigA[TDClearRSOC] = 1
[FD]	Cell Voltage	Max cell voltage _{1..2} ≥ FD: Clear Voltage Threshold	SOCFlagConfigB[FDClearV] = 1
	RSOC (enable by default)	<i>RelativeStateOfCharge()</i> ≥ FD: Clear % RSOC Threshold	SOCFlagConfigB[FDClearRSOC] = 1

4.8 Terminate Charge and Discharge Alarms

When the protections are triggered, the *BatteryStatus()*[TCA][TDA][FD][OCA][OTA] flags are set according to gauging status and safety protections. The following is a summary of the set conditions and their various alarm flags:

[TCA] = 1

- *SafetyAlert()*[OCC], [COV], [OTC] = 1 OR
- *GaugingStatus()*[TC] = 1 AND in CHARGE mode

[OCA] = 1 if

- *SafetyStatus()*[OC] = 1 AND in CHARGE mode

[TDA] = 1

- *SafetyAlert()*[OCD], [COV], [OTC] = 1 OR
- *GaugingStatus()*[TD] = 1 AND in DISCHARGE mode

[FD] = 1 if

- *GaugingStatus()*[FD] = 1

[OTA] = 1 if

- *SafetyStatus()*[OTC], [OTD] = 1

4.9 Precharge

The device enters PRECHARGE mode if any cell voltage goes below **Charging Voltage Low**. The external CHG FET can be used in PRECHARGE mode. Setting the **Pre-Charging: Current** = 0 mA disables the precharge function by requesting 0 mA charging current from the charger. The **[PCHG]** = 1. CHG FET is used in PRECHARGE mode.

The device also supports 0-V charging. It enables the hardware 0-V charging circuit automatically when the battery stack voltage is below the minimum operation voltage of the device. See the *BQ28Z610 1-Cell to 2-Series Cell Li-Ion Battery Pack Manager Data Sheet (SLUSAS3)* for BQ28Z610 electrical specifications.

4.10 Maintenance Charge

Maintenance charge **[MCHG]** can allow charge after termination has been reached. This is only possible if the **GaugingStatus()[TC]** flag is not set. This means to use maintenance charge. **[TCSETSOC]** should not be enabled, and instead **[TCSETV]** can be used to stop maintenance charge based on voltage. Also, **[CHGFET]** should be disabled so that, on detection of a valid primary termination, the charge FET does not open.

Status	Condition	Action
Set	ChargingStatus()[IN] = 0 AND ChargingStatus()[SU] = 0 AND ChargingStatus()[PV] = 0 AND GaugingStatus()[TCA] = 1	ChargingStatus()[MCHG] = 1 ChargingVoltage() = Charging Algorithm ChargingCurrent() = Charging Algorithm
Clear	ChargingStatus()[IN] = 1 OR ChargingStatus()[SU] = 1 OR ChargingStatus()[PV] = 1 OR GaugingStatus()[TCA] = 0	ChargingStatus()[MCHG] = 0 ChargingVoltage() = Charging Algorithm ChargingCurrent() = Charging Algorithm

4.11 BROADCAST Mode

NOTE: BROADCAST mode is available in the latest firmware version in the BQ28Z610 product folder on Ti.com. BROADCAST mode is not included in the shipped version.

The BQ28Z610 gauge enables a smart battery to become the I²C master to broadcast the charging voltage and current to a smart battery charger. This allows the charger and gauge to operate autonomously to adjust the charging conditions dynamically without requiring the host or system to be booted or active. For more information, see [Charger](#).

The **[BCAST]** bit enables all broadcasts to a host or a smart charger. When the **[BCAST]** bit is enabled, the following broadcasts are sent:

- ChargingVoltage()** and **ChargingCurrent()** broadcasts are sent to the smart-charger **Device Address**, and the broadcast period is set in **Broadcast Pacing**. The target registers accessed for writing **ChargingVoltage()** and **ChargingCurrent()** values to the charger device are configured in the data flash register **Voltage Register** and the data flash register **Current Register**, respectively.

4.12 Charge Disable and Discharge Disable

The BQ28Z610 device can disable charging if certain safety conditions are detected, setting the **OperationStatus()[XCHG]** = 0.

Status	Condition	Action
Normal	SafetyStatus()[COV] = 0 AND SafetyStatus()[OCC] = 0,0 AND SafetyStatus()[ASCC] = 0 AND AND SafetyStatus()[CTO] = 0 AND SafetyStatus()[PTO] = 0 AND GaugingStatus()[TCA] = 0 if Charging Configuration[CHGFET] = 1	ChargingVoltage() = Charging Algorithm ChargingCurrent() = Charging Algorithm OperationStatus()[XCHG] = 0

Status	Condition	Action
Trip	$ManufacturingStatus()[FET_EN] = 0$ OR $SafetyStatus()[COV] = 1$ OR $SafetyStatus()[OCC] = 1$ OR $SafetyStatus()[ASCC] = 1$ OR $SafetyStatus()[CTO] = 1$ OR $SafetyStatus()[PTO] = 1$ OR $SafetyStatus()[OC] = 1$ OR $SafetyStatus()[UTC] = 1$ OR $SafetyStatus()[OTC] = 1$ if $ChargingStatus()[IN] = 1$ if $[CHGIN] = 1$ OR $ChargingStatus()[SU] = 1$ if $[CHGSU] = 1$ OR $OperationStatus()[SLEEP] = 1$ if AND $[SLEEPCHG] = 0$ OR $GaugingStatus()[TCA] = 1$ if Charging Configuration $[CHGFET] = 1$	$ChargingVoltage() = 0$ $ChargingCurrent() = 0$ $OperationStatus()[XCHG] = 1$

Similarly, the device can disable discharge of certain safety conditions if any of the following conditions are detected, setting the $OperationStatus()[XDSG] = 1$:

- $ManufacturingStatus()[FET_EN] = 0$ OR
- Any $PFStatus()$ set OR
- $SafetyStatus()[OCD]$ or $[CUV]$ or $[AOLD]$ or $[ASCD]$ or $[UTD] = 1$ OR
- $SafetyStatus()[OTD] = 1$ OR
- $OperationStatus()[SDM] = 1$ AND delay time > **FET Off Time** OR
- $OperationStatus()[SDV] = 1$ AND low voltage time \geq **Shutdown Time**.

4.13 Charge Inhibit

The BQ28Z610 device can inhibit the start of charging at high and low temperatures to prevent damage of the cells. This feature prevents the start of charging when the temperature is at the inhibit range; therefore, if the device is already in the charging state when the temperature reaches the inhibit range, the inhibit state will not be detected and there will be no FET action until charging stops. Instead, the charge suspend feature must be used to stop active charge due to temperature.

Status	Condition	Action
Normal	$ChargingStatus()[LT] = 1$ OR $ChargingStatus()[STL] = 1$ OR $ChargingStatus()[RT] = 1$ OR $ChargingStatus()[STH] = 1$	$ChargingStatus()[IN] = 0$ $ChargingVoltage() =$ charging algorithm $ChargingCurrent() =$ charging algorithm
Trip	Not charging AND $(ChargingStatus()[HT] = 1$ OR $ChargingStatus()[OT] = 1)$ OR $ChargingStatus()[UT] = 1$	$ChargingStatus()[IN] = 1$ $ChargingStatus()[SU] = 0$ $ChargingVoltage() = 0$ $ChargingCurrent() = 0$ $ChargingCurrent()[XCHG] = 1$ if FET Options $[CHGIN] = 1$

4.14 Charge Suspend

The device can stop charging at high and low temperatures to prevent damage of the cells. The charge suspend feature is mutually exclusive with the charge inhibit, so if charge inhibit is set after the device exits charging, then the charge suspend status will be cleared.

Status	Condition	Action
Normal	$ChargingStatus()[LT] = 1$ OR $ChargingStatus()[STL] = 1$ OR $ChargingStatus()[RT] = 1$ OR $ChargingStatus()[STH] = 1$ OR $ChargingStatus()[HT] = 1$ OR $ChargingStatus()[IN] = 1$	$ChargingStatus()[SU] = 0$ $ChargingVoltage() =$ charging algorithm $ChargingCurrent() =$ charging algorithm
Trip	$ChargingStatus()[UT] = 1$ OR $ChargingStatus()[OT] = 1$	$ChargingStatus()[SU] = 1$ $ChargingVoltage() = 0$ $ChargingCurrent() = 0$ No charging is allowed if FET Options $[CHGSU] = 1$.

Power Modes

5.1 Introduction

To enhance battery life, the BQ28Z610 supports several power modes to minimize power consumption during operation.

5.2 NORMAL Mode

In NORMAL mode, the device takes voltage, current, and temperature readings every 250 ms, performs protection and gauging calculations, updates data, and makes status selections at 1-s intervals. Between these periods of activity, the device is in a reduced power state.

5.3 SLEEP Mode

5.3.1 Device Sleep

When the sleep conditions are met, the device goes into SLEEP mode with periodic wake-ups to reduce power consumption. The device returns to NORMAL mode if any exit sleep condition is met.

Status	Condition	Action
Activate	If $[IN_SYSTEM_SLEEP] = 0$ OR No communication for Bus Timeout if $[IN_SYSTEM_SLEEP] = 1$ AND $DA\ Config[SLEEP] = 1^{(1)}$ AND $ Current() \leq Sleep\ Current$ AND $Voltage\ Time > 0$ AND $OperationStatus()[SDM] = 0$ AND No <i>SafetyAlert()</i> bits set AND ⁽²⁾ No <i>[AOLD]</i> , <i>[ASCC]</i> , <i>[ASCD]</i> , set in <i>SafetyStatus()</i>	Turn off CHG FET if $DA\ Configuration[SLEEPCHG] = 0$. The device goes to sleep. The device wakes up every Sleep:Voltage Time period to measure voltage and temperature. Device wakes up every Sleep:Current Time period to measure current.
Exit	I^2C connected ⁽¹⁾ OR I^2C bus activity ⁽³⁾ OR $DA\ Config[SLEEP] = 0^{(1)}$ OR $ Current() > Sleep\ Current$ OR Wake comparator activates ⁽⁴⁾ OR $Voltage\ Time = 0$ OR $OperationStatus()[SDM] = 1$ OR $SafetyAlert()$ bits set OR $[AOLD]$, $[ASCC]$, $[ASCD]$, set in <i>SafetyStatus()</i>	Return to NORMAL mode

⁽¹⁾ *DA Config[SLEEP]* and I^2C low are not checked if the *AltManufacturerAccess()* SLEEP mode command is used to enter SLEEP mode.

⁽²⁾ *SafetyAlert()[PTO]*, *[PTOS]*, *[CTO]*, *[CTOS]* will not prevent the gauge to enter SLEEP mode.

⁽³⁾ Wake on I^2C command is only possible when the gas gauge is put to sleep using the *AltManufacturerAccess()* SLEEP mode command or $[IN_SYSTEM_SLEEP]$ is enabled with **Bus Timeout** = 0. Otherwise, the gas gauge wakes on an I^2C connection (clock or data high).

⁽⁴⁾ The wake comparator threshold is set through *Power.WakeComparator[WK1,WK0]* (see Section 5.3.4).

5.3.2 IN SYSTEM SLEEP Mode

IN SYSTEM SLEEP mode is useful for systems with embedded battery packs where the serial communication lines typically remain high in sleep scenarios. Setting $DA\ Config[IN_SYS_SLEEP] = 1$ will modify the SLEEP exit conditions such that SMBus connection alone will not trigger wake, and instead receiving a valid SMBus command is required. All other characteristics remain unchanged and the same SLEEP mode entry criteria apply.

5.3.3 *AltManufacturerAccess()* MAC Sleep

The sleep MAC command can override the requirement for bus low to enter SLEEP mode. In this case, the part clock and data high condition is ignored for SLEEP to exit, though SLEEP will also exit if there is any further communication. The BQ28Z610 device can be sent to sleep with *AltManufacturerAccess()* if specific sleep entry conditions are met.

5.3.4 Wake Function

The BQ28Z610 device can exit SLEEP mode if enabled by the presence of a voltage across SRP and SRN. The voltage threshold needed for the device to wake from SLEEP mode is programmed in **Power:Wake Comparator**.

Reserved (Bits 7–4, 1–0): Reserved. Do not use.

WK1,0 (Bits 3–2): Wake Comparator Threshold

WK1	WK0	Voltage
0	0	±0.625 mV
0	1	±1.25 mV
1	0	±2.5 mV
1	1	±5 mV

5.4 SHUTDOWN Mode

5.4.1 Voltage Based Shutdown

To minimize power consumption and avoid draining the battery, the device can be configured to shut down at a programmable stack voltage threshold.

Status	Condition	Action
Enable	Min cell voltage < Shutdown Voltage	<i>OperationStatus()</i> [SDV] = 1
Trip	Min cell voltage continuous < Shutdown Voltage for Shutdown Time	Turn DSG FET off
Shutdown	Voltage at PACK terminal < Charger Present Threshold AND <i>Current()</i> ≤ 0	Send device into SHUTDOWN mode
Exit	Voltage at PACK terminal > V _{STARTUP} OR Min cell voltage > Shutdown Voltage if not in SHUTDOWN mode	<i>OperationStatus()</i> [SDV] = 0 Return to NORMAL mode

NOTE: The device goes through a full reset when exiting from SHUTDOWN mode, which means the device will reinitialize. On power up, the gauge checks certain special memory locations. If the memory checksum is incorrect, or if either the gauge or the AFE watchdog has been triggered, the gauge will do a full reset.

If the memory checksum is good, for example in the case of a short power glitch, the gauge will do a partial reset. The initialization is faster in partial reset, and certain memory data will not be reinitialized (for example, all SBS registers, last known FET state, last ADC and CC readings, and so on) and so a partial reset is usually transparent to the host.

5.4.2 *AltManufacturerAccess()* MAC Shutdown

In SHUTDOWN mode, the device turns off the CHG and DSG FETs after **FET Off Time**, and then shuts down to minimize power consumption after **Delay** time. Both **FET Off Time** and **Delay** time are referenced to the time the gauge received the command. Thus, the **Delay** time must be set longer than the **FET Off Time**. The device returns to NORMAL mode when the voltage at PACK terminal $> V_{\text{Startup}}$. The device can be sent to this mode with the *AltManufacturerAccess()**Shutdown* command. Charger voltage must not be present for the device to enter SHIP SHUTDOWN mode. If there is charger voltage present or charge current is flowing, the device will wait until the charger is removed to enter the SHUTDOWN state. This is to prevent the device from unintended, immediate wake-up. The *Shutdown()* command cannot be canceled.

NOTE: If the gauge is unsealed and the MAC *Shutdown()* command is sent twice in a row, the gauge will execute the shutdown sequence immediately and skip the normal delay sequence.

5.4.3 *Time Based Shutdown*

The device can be configured to shut down after staying in SLEEP mode without communication for a preset time interval specified in the **Auto Ship Time**. Setting the **PowerConfig[AUTO_SHIP_EN] = 1** enables this feature. Any communication to the device will restart the timer. When the timer reaches the Auto Ship Time, the time-based shutdown effectively triggers the MAC shutdown command to start the shutdown sequence. The device returns to NORMAL mode when voltage at PACK terminal $> V_{\text{Startup}}$.

5.4.4 *Emergency FET Shutdown*

The Emergency FET Shutdown function provides an option to disable the battery power to the system by opening up the CHG and DSG FETs before removing an embedded battery pack. The EMERGENCY FET SHUTDOWN state is enabled by setting **DA Configuration[EMSHUTEN] = 1**. It is entered by sending a Manual FET Control (MFC) sequence to *ManufacturerAccess()*.

When the gauge is in the EMERGENCY FET SHUTDOWN state, the *OperationStatus()*[EMSHUT] = 1.

The manual FET control (MFC) sequence to put the gauge into the EMERGENCY FET SHUTDOWN state is described below.

- a. Send word 0x270C to *ManufacturerAccess()* (0x00) to enable the MFC.
- b. Within 4 s, send word 0x043D to *ManufacturerAccess()* (0x00) to turn off CHG and DSG FETs.
- c. The CHG and DSG FETs will be turned off.

5.4.4.1 *Exiting Emergency FET Shutdown*

The gauge can exit the EMSHUT mode by turning on the CHG and DSG FETs with any one of the following conditions:

- Send word 0x23A7 to *ManufacturerAccess()* (0x00).
- Voltage at Pack pin $>$ **Charger Present Threshold** for two sample periods (that is, ~500 ms)
- Valid I²C bus communication is received. Valid I²C bus communication means a valid gauge address and any command is received (that is, an invalid command with a valid address is OK).

In EMSHUT mode, to detect the voltage level at the Pack pin quickly (even while in SLEEP), the AD conversion occurs every second.

Gauging

6.1 Introduction

The BQ28Z610 measures individual cell voltages, pack voltage, temperature, and current. It determines battery state-of-charge by analyzing individual cell voltages when a time exceeding 10 minutes has passed since the last charge or discharge activity of the battery.

The BQ28Z610 measures charge and discharge activity by monitoring the stable voltage across a small-value series sense resistor (1 mΩ typ.) between the negative terminal of the cell stack and the negative terminal of the battery pack. The battery state-of-charge is subsequently adjusted during load or charger application using the integrated charge passed through the battery. The device is capable of supporting a maximum battery pack capacity of 32 Ah. See the "Theory and Implementation of Impedance Track Battery Fuel-Gauging Algorithm" in the *bq20zxx Product Family Application Report (SLUA364)* for further details.

The default for Impedance Track gauging is *off*. To enable the gauging function, set **Manufacturing Status[GAUGE_EN]** = 1. The gauging function will be enabled after a reset or a seal command is set. Alternatively, the MAC command *Gauging()* can be used to turn on and off the gauging function. *Gauging()* takes an immediate effect and the **[GAUGE_EN]** is also updated accordingly.

The *ITStatus1()*, *ITStatus2()*, and *ITStatus3()* commands return various gauging related information, which is useful for problem analysis.

6.2 Impedance Track Configuration

Load Mode — During normal operation, the battery-impedance profile compensation of the Impedance Track algorithm can provide more accurate full-charge and remaining state-of-charge information if the typical load type is known. The two selectable options are constant current (**Load Mode** = 0) and constant power (**Load Mode** = 1).

Load Select — To compensate for the $I \times R$ drop near the end of discharge, the BQ28Z610 must be configured for whatever current (or power) will flow in the future. While it cannot be exactly known, the BQ28Z610 can use load history, such as the average current of the present discharge to make a sufficiently accurate prediction.

The BQ28Z610 can be configured to use several methods of this prediction by setting the **Load Select** value. Because this estimate has only a second-order effect on remaining capacity accuracy, different measurement-based methods (methods 0 to 3, and method 7) result in only minor differences in accuracy. However, methods 4–6, where an estimate is arbitrarily assigned by the user, can result in a significant error if a fixed estimate is far from the actual load. For highly variable loads, selection 7 provides the most balanced estimate and is preferable.

Constant Current (Load Mode = 0)	Constant Power (Load Mode = 1)
0 = Avg I Last Run	Avg P Last Run
1 = Present average discharge current	Present average discharge power
2 = <i>Current()</i>	<i>Current()</i> × <i>Voltage()</i>
3 = <i>AverageCurrent()</i>	<i>AverageCurrent()</i> × average <i>Voltage()</i>
4 = Design Capacity/5	Design Energy/5
5 = <i>AtRate()</i> (mA)	<i>AtRate()</i> (10 mW)
6 = User Rate-mA	User Rate-mW
7 = Max Avg I (default)	Max Avg P

Pulsed Load Compensation and Termination Voltage — To take into account pulsed loads while calculating remaining capacity until **Term Voltage** threshold is reached, the BQ28Z610 monitors not only average load but also short load spikes. The maximum voltage deviation during a load spike is continuously updated during discharge and stored in **Delta Voltage**, with the minimum value allowed set in **Min Delta Voltage**.

Reserve Battery Capacity — The BQ28Z610 allows an amount of capacity to be reserved in both mAh (**Reserve Cap-mAh**) and cWh (**Reserve Cap-cWh**) units between the point where the *RemainingCapacity()* function reports zero capacity and the absolute minimum pack voltage, **Term Voltage**. This enables a system to report zero capacity/energy, but still have enough reserve capacity/energy to perform a controlled shutdown or provide an extended sleep period for the host system.

Pack Based AND Cell Based Termination Voltage — The BQ28Z610 device forces *RemainingCapacity()* to 0 mAh when the battery stack voltage reaches **Term Voltage**. If **Impedance Track Gauging Configuration[CELL_TERM] = 1**, the cell-based termination is used, and the **Term Min Cell V** threshold is checked for a termination condition. The cell-based termination provides an option to enable the gauge to reach 0 mAh before the device triggers CUV, especially for an imbalanced pack.

6.3 Gas Gauge Modes

Resistance updates take place only in DISCHARGE mode, while OCV and QMax updates only take place in RELAX mode. Entry and exit of each mode is controlled by data flash parameters in the subclass **Gas Gauging: Current Thresholds** section. When the device is determined to be in RELAX mode and OCV is taken, the *GaugingStatus[REST]* flag is set. In RELAX mode or DISCHARGE mode, the DSG flag in *BatteryStatus* is set.

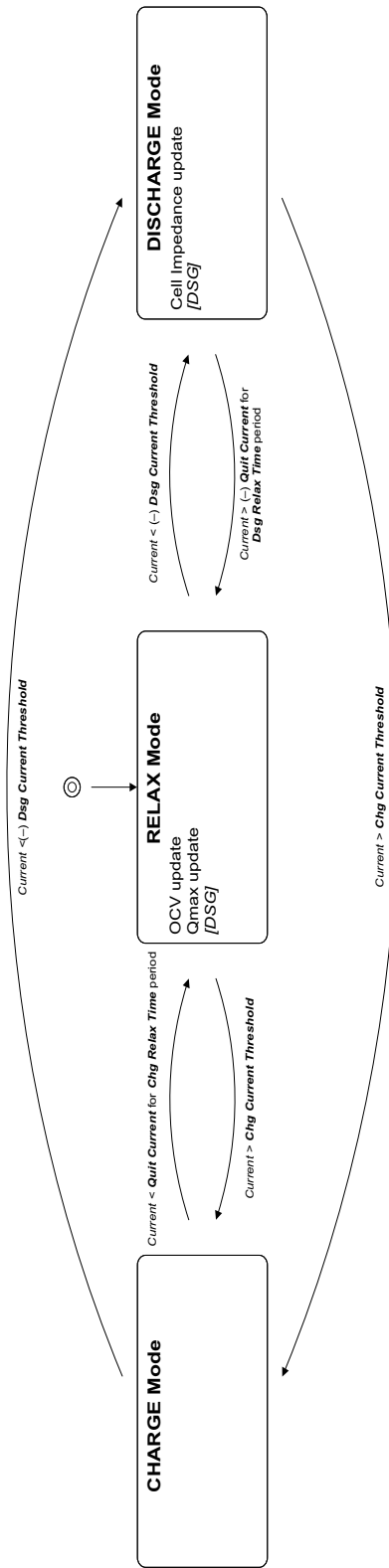

Figure 6-1. Gas Gauge Operating Modes

CHARGE mode is exited and RELAX mode is entered when *Current* goes below **Quit Current** for a period of **Chg Relax Time**. DISCHARGE mode is entered when *Current* goes below **(-)Dsg Current Threshold**. DISCHARGE mode is exited and RELAX mode is entered when *Current* goes above **(-)Quit Current** threshold for a period of **Dsg Relax Time**. CHARGE mode is entered when *Current* goes above **Chg Current Threshold**.

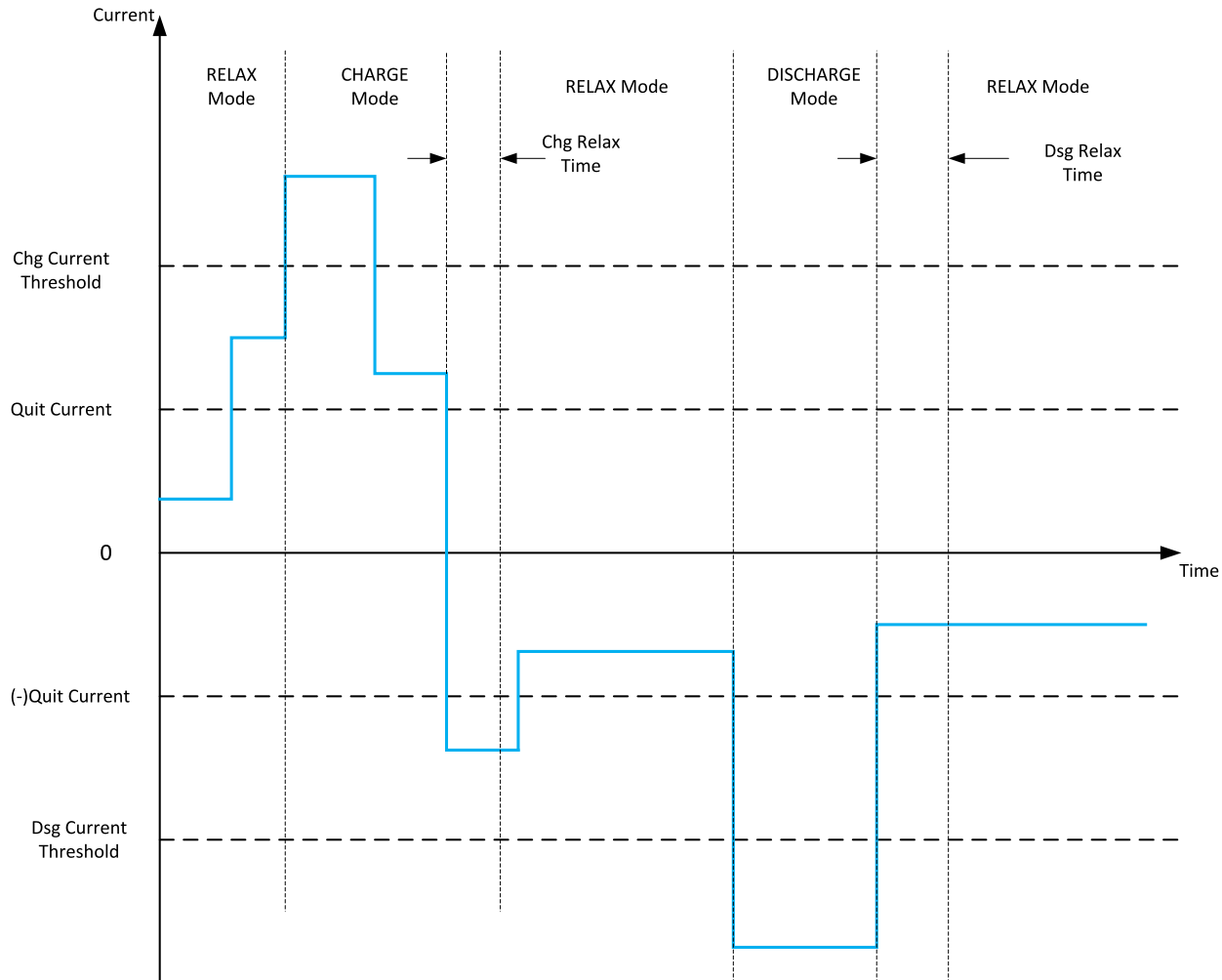

Figure 6-2. Gas Gauge Operating Mode Example

6.4 QMax and Ra

The total battery capacity is found by comparing states of charge before and after applying the load with the amount of charge passed. When an applications load is applied, the impedance of each cell is measured by comparing the open circuit voltage (OCV) obtained from a predefined function for present state-of-charge with the measured voltage under load.

Measurements of OCV and charge integration determine chemical state-of-charge (SOC) and Chemical Capacity (*QMax*).

The BQ28Z610 acquires and updates the battery-impedance profile during normal battery usage. It uses this profile, along with state-of-charge and the *QMax* values, to determine *FullChargeCapacity* and *RelativeStateOfCharge* specifically for the present load and temperature. *FullChargeCapacity* reports a capacity or energy available from a fully charged battery reduced by **Reserve Cap-mAh** or **Reserve Cap-cWh** under the present load and present temperature until *Voltage* reaches the **Term Voltage** for a period of **Term V Hold Time**.

6.4.1 QMax Initial Values

The initial **QMax Pack**, **QMax Cell 0**, and **QMax Cell 1** values should be taken from the cell manufacturers' data sheet multiplied by the number of parallel cells, and are also used for the *DesignCapacity* function value in the **Design Capacity** data flash value.

See the "Theory and Implementation of Impedance Track Battery Fuel-Gauging Algorithm" in the *bq20zxx Product Family Application Report (SLUA364)* for further details.

6.4.2 QMax Update Conditions

QMax update is enabled when gauging is enabled. This is indicated by the *GaugingStatus[QEN]* flag. The BQ28Z610 updates the no-load full capacity (QMax) when two open circuit voltage (OCV) readings are taken. These OCV readings are taken when the battery is in a RELAXED state before and after charge or discharge activity. A RELAXED state is achieved if the battery voltage has a dV/dt of $< 4 \mu V/s$. Typically it takes 2 hours in a CHARGED state and 5 hours in a DISCHARGED state to ensure that the dV/dt condition is satisfied. If 5 hours are exceeded, a reading is taken even if the dV/dt condition was not satisfied. The *GaugingStatus[REST]* flag is set when a valid OCV reading occurs. If a valid DOD0 (taken at a previous QMax update) is available, then QMax will also be updated when a valid charge termination is detected.

Temperature — If *Temperature* is outside of the range 10°C to 40°C.

Delta Capacity — If the capacity change between suitable battery rest periods is less than 37%.

Voltage — If *CellVoltage2..1* is inside a flat voltage region. (See the *Support of Multiple Li-Ion Chemistries with Impedance Track Gas Gauges Application Report (SLUA372)* for the voltage ranges of other chemistries.) This flat region is different with different chemistry. The *GaugingStatus[OCVFR]* flag indicates if the cell voltage is inside this flat region.

Offset Error — If offset error accumulated during time passed from previous OCV reading exceeds 1% of *Design Capacity*, update is disqualified. Offset error current is calculated as **CC Deadband**/sense resistor value.

Several flags in *GaugingStatus()* are helpful to track for QMax update conditions. The *[REST]* flag indicates an OCV is taken in RELAX mode. The *[VOK]* flag indicates the last OCV reading is qualified for the QMax update. The *[VOK]* is set when charge or discharge starts. It will be cleared when the QMax update occurs, when the offset error for a QMax disqualification is met, or when there is a full reset. The *[QMax]* flag will be toggled when the QMax update occurs. *ITStatus2()* and *ITStatus3()* return the QMax and DOD (depth of discharge, corresponding to the OCV reading) data.

6.4.3 Fast QMax Update Conditions

The Fast QMax Update Conditions are very similar to the QMax Update Conditions with the following differences:

- Instead of taking two OCV readings for QMax update, Fast QMax update requires only one OCV reading AND
- The battery pack should discharge $> 10\%$ RSOC.

The differences in requirements allow the Fast QMax feature to have a QMax update at the end of discharge (given one OCV reading is already available and discharge $< 10\%$ RSOC) without a longer relax time after a discharge event. The Temperature, Delta Capacity, Voltage, and Offset Error requirements for a QMax update are still required for the Fast QMax update.

This feature is particularly useful for reducing production QMax learning cycle time or for an application that is mostly in CHARGE or DISCHARGE state with infrequent relaxation. Setting **IT Gauging Configuration[FAST_QMax_LRN] = 1** enables Fast QMax during production learning only (that is, **Update Status = 6**).

The DOD is taken for QMax at a high state-of-charge, then during discharge when at the steep portion of the voltage curve (85–90% DOD). This allows a good estimation of DOD again. This DOD estimation during discharge is used to update QMax immediately instead of needing a rest period first. The actual update to QMax happens when the discharge stops after verifying that no conditions were present that would cause the QMax update to fail. The BQ28Z610 has an option to have DOD@EOC be valid for QMax updates, which means it is possible to update QMax with no rest periods at all (by having a charge termination followed by a full discharge); however, this is only recommended for certain new chemistries. Fast QMax can be enabled in either LEARN mode (**FAST_QMax_LRN**) or FIELD mode (**FAST_QMax_FLD**). The LEARN mode flag means Fast QMax is only enabled in IT state “06”, and will be disabled once 0E is reached. FIELD mode is enabled in both “06” and “0E” states.

6.4.4 QMax and Fast QMax Update Boundary Check

The BQ28Z610 implements a QMax and Fast QMax check prior to saving the value to data flash. This improves the robustness of the QMax update in case of potential QMax corruption during the update process.

The verifications are as follows:

1. Verify that the updating QMax or Fast QMax value is within **QMaxDelta**, which is the maximum allowed QMax change for each update. If the updating value is outside of this data flash parameter, the BQ28Z610 caps the change to **QMaxDelta** of the Design Capacity.
2. Bound the absolute QMax value, **QMax Upper Bound**. This is the maximum allowed QMax value over the lifetime of the pack.
3. Ensure that QMax is greater than 0 before saving to data flash.

6.4.5 Ra Table Initial Values

The Ra table is part of the impedance profile that updates during discharge when gauging is enabled. The initial **Cell0 R_a0...14**, **Cell1 R_a0...14**, values should be programmed by selecting the correct chemistry data during data flash configuration. A chemistry database is constantly updating, and can be downloaded from the Gas Gauge Chemistry Updater product web page (<http://www.ti.com/tool/gasgaugechem-sw>). The initial **xCell0 R_a0...14**, **xCell1 R_a0...14** values are a copy of the non-x data set. Two sets of Ra tables are used alternatively when gauging is enabled to prevent wearing out the data flash.

The **Cell0 R_a Flag**, **Cell1 R_a Flag**, and the **xCell0 R_a Flag**, **xCell1 R_a Flag**, indicate the validity of the cell impedance table for each cell. Firmware updates these values: It is not recommended to change them manually.

High Byte		Low Byte	
0x00	Cell impedance and QMax updated	0x00	Table not used and QMax updated
0x05	RELAX mode and QMax update in progress	0x05	RSVD
0x55	DISCHARGE mode and cell impedance updated	0x55	Table being used
0xFF	Cell impedance never updated	0xFF	Table never used, no QMax or cell impedance update

6.4.6 Ra Table Update Conditions

The impedance is different across different DOD states. Each cell has 15 Ra grid points presenting the impedance from 0%–100% DOD. In general, the Ra table is updated during discharge. The **GaugingStatus[RX]** flag will toggle when the Ra grid point is updated. The Ra update is disabled if any of the following conditions are met. The **GaugingStatus[R_DIS]** is set to indicate the Ra update is disabled.

- During the optimization cycle, the Ra update is disabled until QMax is updated (that is, Ra will not be updated if Update Status = 4) OR
- Ra update is disabled if the charge accumulation error > 2% of Design Capacity OR
- During a discharge, a bad Ra value is calculated:

- A negative Ra is calculated or
- A bad RaScale value is calculated.

A valid OCV reading during RELAX mode or a fast QMax update without an OCV read will clear the *[R_DIS]* flag.

6.5 FullChargeCapacity (FCC), RemainingCapacity (RemCap), and RelativeStateOfCharge (RSOC)

The Impedance Track algorithm applies QMax, impedance, temperature, voltage, and current data to predict the runtime *FullChargeCapacity()*, *RemainingCapacity()*, and *RelativeStateOfCharge()*. These values are updated if any of the following conditions are met, reflecting the battery capacity at real time:

- QMax update occurs
- Ra update occurs
- At onset of charge and discharge
- At exit of discharge
- Every 5 hours in RELAX mode
- If temperature changes more than 5°C

6.6 Impedance Track (IT) Configuration Options

The BQ28Z610 provides several Impedance Track configuration options to fine-tune the gauging performance. These configurations can be turned on or off through the corresponding flags in **Settings: IT Gauging Configuration**.

[LOCK0]: After a discharge event, cell voltage will usually recover to a slightly higher voltage during RELAX state. A new OCV reading during this time can result in a slightly higher state-of-charge. This flag provides an option to keep *RemainingCapacity()* and *RelativeStateOfCharge()* jumping back during relaxation after 0% and FD are reached during discharge.

[RSOC_HOLD]: An IT simulation will run at the onset of discharge. If charge terminates at a low temperature and discharge occurs at a higher temperature, the difference in temperature could cause a small rise of RSOC for a short period of time at the beginning of discharge. This flag option prevents RSOC rises during discharge. RSOC will be held until the calculated value falls below the actual state.

[RSOCL]: When set will be held to 99% until charge termination is detected.

[RFACTSTEP]: The gauge keeps track of an Ra factor of the old (old Ra)/(new Ra) during the Ra update. This factor is used for Ra scaling. It is limited to 3 max. During an Ra update, if (old Ra)/(new Ra) > 3, the gauge can take on two different actions based on the setting of this flag.

If the flag is set to 1 (default), the gauge allows Ra to update once using the max factor of 3, then disables the Ra update. If this flag is set to 0, the gauge will not update Ra and also disables the Ra update. It is recommended to keep the default setting.

[OCVFR]: An OCV reading is taken when a dV/dt condition is met. This is not the case if charging stops within the flat voltage region. The change of cell voltage in this region is very small; therefore, a same voltage error can correspond to a larger DOD error. By default, this flag is set. The device will take a 48-hour wait before taking an OCV reading if charging stops below the **FlatVoltMax** (max flat region voltage). The **FlatVoltMax** is different with different chemistry. A short discharge will not cancel this 48-hour wait. The 48-hour wait will only be cleared if charging stops above the **FlatVoltMax** level. Setting this flag to 0 will remove the 48-hour wait requirement, and OCV will be taken whenever the dV/dt condition is met. Removing the 48-hour requirement can be useful sometimes to reduce test time during evaluation.

[RSOC_CONV]: This function is also called fast scaling. It is an option to address the convergence of RSOC to 0% at a low temperature and a very high rate of discharge. Under such conditions, it is possible to have a drop of RSOC to 0%, especially if the termination voltage is reached at the DOD region with a higher Ra grid interval. To account for the error caused by the high granularity of the impedance grid interval, the **[RSOC_CONV]**, when enabled, applies a scale factor to impedance, allowing more frequent impedance data updates used for RemCap simulation leading up to 0% RSOC.

[Fast_QMax_LRN] and **[Fast_QMax_FLD]:** The first flag enables fast QMax during the learning cycle when **Update Status** = 06. The second flag enables fast QMax in the field when **Update Status** ≥ 06.

If **[RSOC_CONV]** is enabled, it is recommended to start this function around the knee region of the discharge curve. This is usually around 10% of RSOC or around 3.3 V–3.5 V. This function checks for cell voltage and RSOC status and starts the function when either condition is met. The RSOC and cell voltage setting can be configured through **Fast Scale Start SOC** or **Term Voltage**.

If **[FF_NEAR_EDV]**: Fast Filter Near EDV. If this flag is set, the gauge applies an alternative filter, **Near EDV Ra Param Filter**, for an Ra update in the fast scaling region (starting around 105 RSOC). This flag should be kept to 1 as a default. When this flag is 0, the gauge uses the regular Ra filter, **Resistance Parameter Filter**. Both DF filters should not be changed from the default value.

[SMOOTH]: A change in temperature or current rate can cause a significant change in Remaining Capacity (RemCap), and therefore results in a jump or drop in the Relative State-of-Charge (RSOC). This function provides an option to prevent an RSOC jump or drop during charge and discharge.

If a jump or drop of RSOC occurs, the device examines the amount of the RSOC jump or drop versus the expected end point (that is, the charge termination for the charging condition or the EDV for the discharge condition) and automatically smooths the change of RSOC, and always converges with the filtered (or smoothed) value to the actual charge termination or EDV point. The actual and filtered values are always available. The **[SMOOTH]** flag selects either the actual or filtered values as a returned SBS command.

[RELAX_JUMP_OK]: If set to 1, this flag enables the RSOC to jump during RELAX mode. Otherwise, RSOC holds constant during RELAX mode and any RSOC jump will be passed into the onset of the charge or discharge phase.

[CELL_TERM]: This flag provides an option to have a cell voltage based discharge termination. If the minimum cell voltage reaches **Term Min Cell V**, *RemainingCapacity()* will be forced to 0 mAh.

[CSYNC]: This flag, if set to 1, synchronizes *FullChargeCapacity()* at valid charge termination.

[CCT]: This flag provides an option to use *FullChargeCapacity()* (when **[CCT]** = 1) or *DesignCapacity()* (when **[CCT]** = 0) for cycle count threshold calculation. The minimum cycle count threshold is always 10% of Design capacity even if *FullChargeCapacity()* is selected for cycle count threshold calculation. This helps to avoid any erroneous cycle count increment caused by an extremely low *FullChargeCapacity()*.

6.7 State-of-Health (SOH)

The device now implements an updated version of the battery state-of-health (SOH), which is reported by the *StateofHealth()* command. In the previous version, the *StateofHealth()* was calculated using a special 25°C version of **FullChargeCapacity** as a fraction of **Design Capacity**. However, this calculation still included some parameters that were updated during operation based on the loading and use of the battery, separate from the battery status itself. This could lead to varying calculations of state-of-health for the same battery, depending on how the battery was used in system. The updated version of *StateofHealth()* addresses this by calculating a special SOH Full Charge Capacity, with the initial ambient temperature fixed at 25°C, using a current load specified by **SOH Load Rate**, and using the thermal model parameters, **SOH Temp a** and **SOH Temp k**.

The **SOH Load Rate** can be set to the typical current of the application, and it is specified in units of hour-rate (that is, **Design Capacity/SOH Load Rate** will be the current used for the SOH simulation). The **SOH Temp a** and **SOH Temp k** can be set to expected values for the system during operation. These data flash settings are used only for the *StateofHealth()* calculation. This SOH Full Charge Capacity is updated whenever ASOC and RSOC are updated. Because this implementation removes the variation of load current, temperature, and learned parameters, it is a better representation of the battery's state-of-health. The SOH Full Charge Capacity is available on the MAC command *FCC_SOH()*.

6.8 Battery Trip Point (BTP)

The Battery Trip Point (BTP) feature indicates when the RSOC of a battery pack has depleted to a certain value set in a DF register. The BTP output uses the TS1 pin.

The BTP feature allows a host to program two capacity-based thresholds that govern the triggering of a BTP interrupt on the BTP_INT pin and the setting or clearing of the *OperationStatus()[BTP_INT]* on the basis of *RemainingCapacity()*. The interrupt is enabled or disabled via **Settings.Configuration.IO Config[BTP_EN]**.

OperationStatus()[BTP_INT] is set when:

- Current > 0 and RemCap > “clear” threshold (“charge set threshold”). This threshold is initialized at reset from **Settings.BTP.Init Charge Set**.
- Current ≤ 0 and RemCap < “set” threshold (“discharge set threshold”). This threshold is initialized at reset from **Settings.BTP.Init Discharge Set**.

- When `OperationStatus()[BTP_INT]` is set, if **Settings.Configuration.IO Config[BTP_EN]** is set, then the BTP_INT pin output is asserted.
- When either `BTPDischargeSet()` or `BTPChargeSet()` commands are received, `OperationStatus()[BTP_INT]` will clear and the pin will be deasserted. The new threshold is written to either `BTPDischargeSet()` or `BTPChargeSet()`.
- At reset, the pin is set to the deasserted state.

Cell Balancing

7.1 Introduction

The BQ28Z610 can determine the chemical state-of-charge of each cell using the Impedance Track algorithm. The cell balancing algorithm used in the device decreases the differences in imbalanced cells in a fully charged state gradually, which prevents fully charged cells from becoming overcharged, causing excessive degradation. This increases overall pack energy by preventing premature charge termination.

The algorithm determines the amount of charge needed to fully charge each cell. There is a bypass FET in parallel with each cell connected to the gas gauge. The FET is enabled for each cell with a charge greater than the lowest charged cell to reduce charge current through those cells. Each FET is enabled for a precalculated time as calculated by the cell balancing algorithm. When any bypass FET is turned on, then the *OperationStatus()[CB]* flag is set; otherwise, the *[CB]* flag is cleared.

The gas gauge balances the cells by balancing the SOC difference. Thus, a field updated QMax (**Update Status** = 0E) is required prior to any attempt of Cell Balance Time calculation. This ensures the accurate SOC delta is calculated for the cell balancing operation. If QMax update has only occurred once (**Update Status** = 06), then the gauge will only attempt to calculate the Cell Balance Time if a fully charged state is reached, *GaugingStatus()[FC]* = 1.

Cell balancing is enabled if **Settings:Balancing Configuration [CB]** = 1. Cell balancing at rest can be enabled separately by setting **Balancing Configuration [CBR]** = 1. If **Settings:Balancing Configuration [CB]** = 0, both cell balancing at charging and at rest are disabled.

Cell balancing at rest can be configured by determining the data flash **Min Start Balance Delta**, **Relax Balance Interval**, and **Min RSOC for Balancing**. For the data flash setting descriptions, see [Cell Balancing Config](#). The gas gauge balances cells by bypassing the energy. It is recommended to perform cell balancing at rest when there is capacity in the battery pack.

7.2 Cell Balancing Setup

The BQ28Z610 is required to be in RELAX mode before it can check if the cells are unbalanced and how much balancing is required. The BQ28Z610 enters RELAX mode when:

Current() < **Quit Current** for at least **Dsg Relax Time** when coming from DISCHARGE mode for **Chg Relax Time** when coming for CHARGE mode.

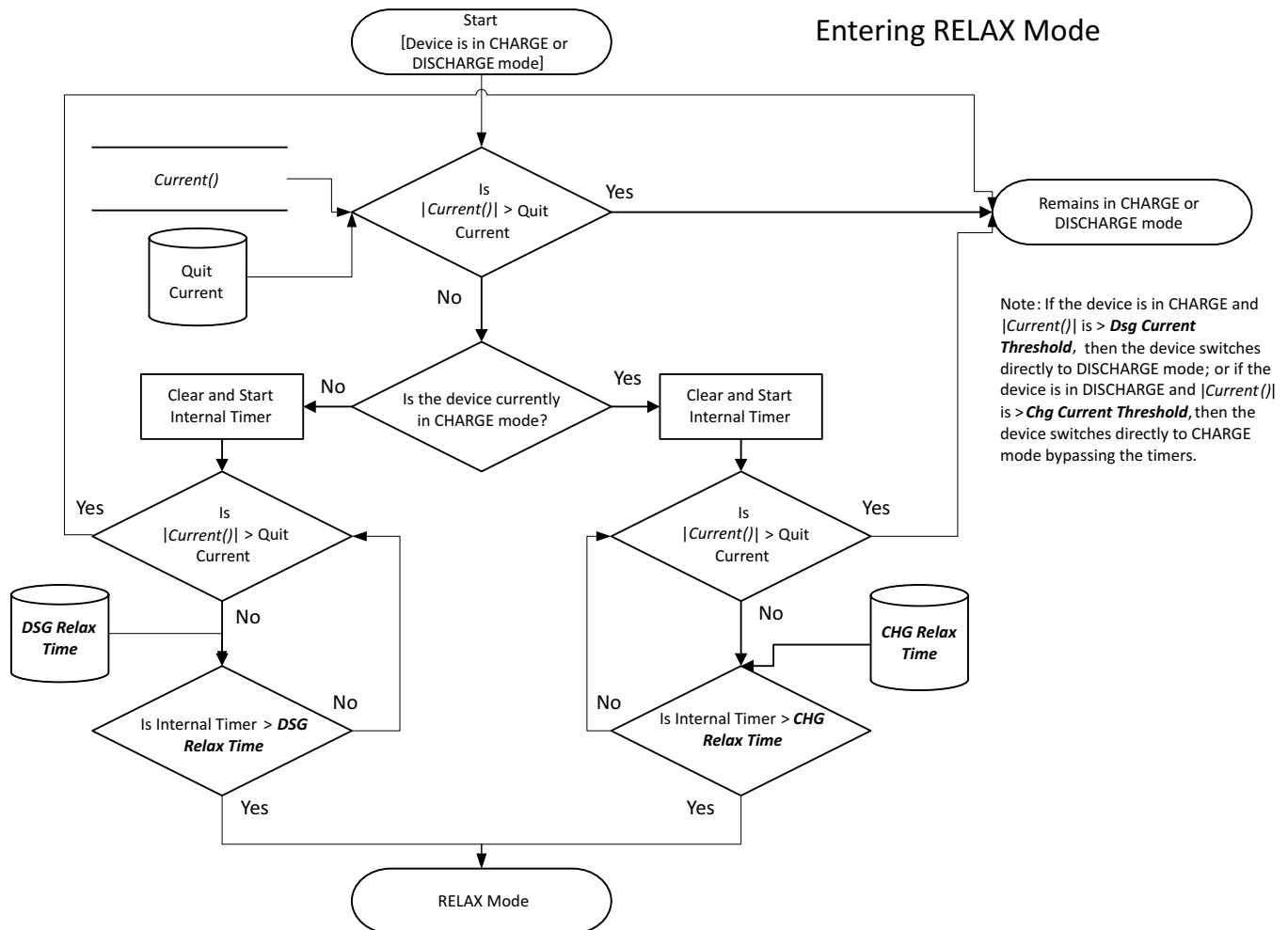

Figure 7-1. Entering CHARGE or RELAX Mode

Once in RELAX mode, the BQ28Z610 waits until an OCV measurement is taken, which occurs after:

1. A dV/dt condition of $< 4\ \mu V/s$ is satisfied,
2. After 5 hours from when $Current() < Quit\ Current$,
3. Upon gas gauge reset,
4. An IT Enable command is issued.

The determination of when to update the OCV data is part of the normal Impedance Track algorithm and is not specific to the cell balancing algorithm.

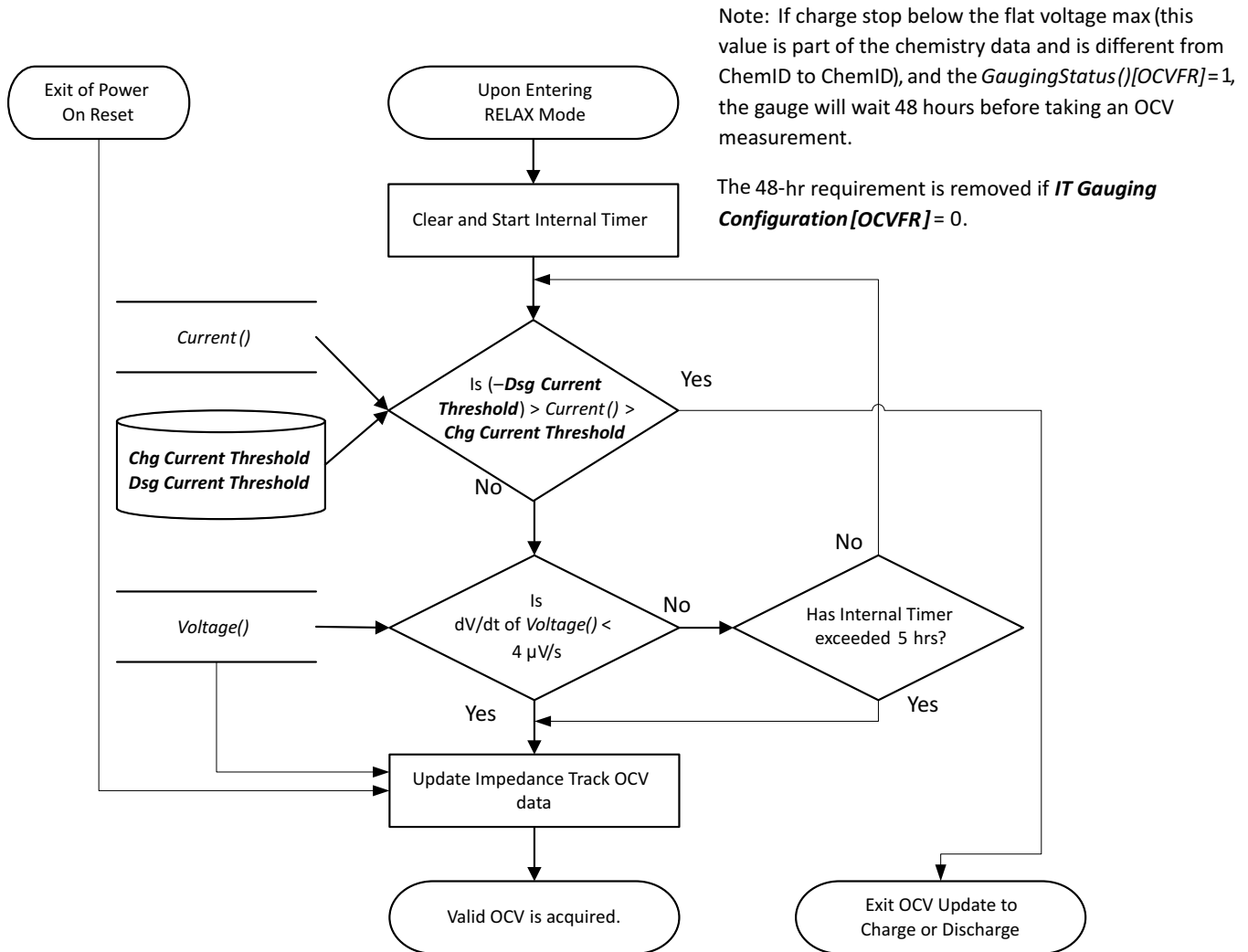
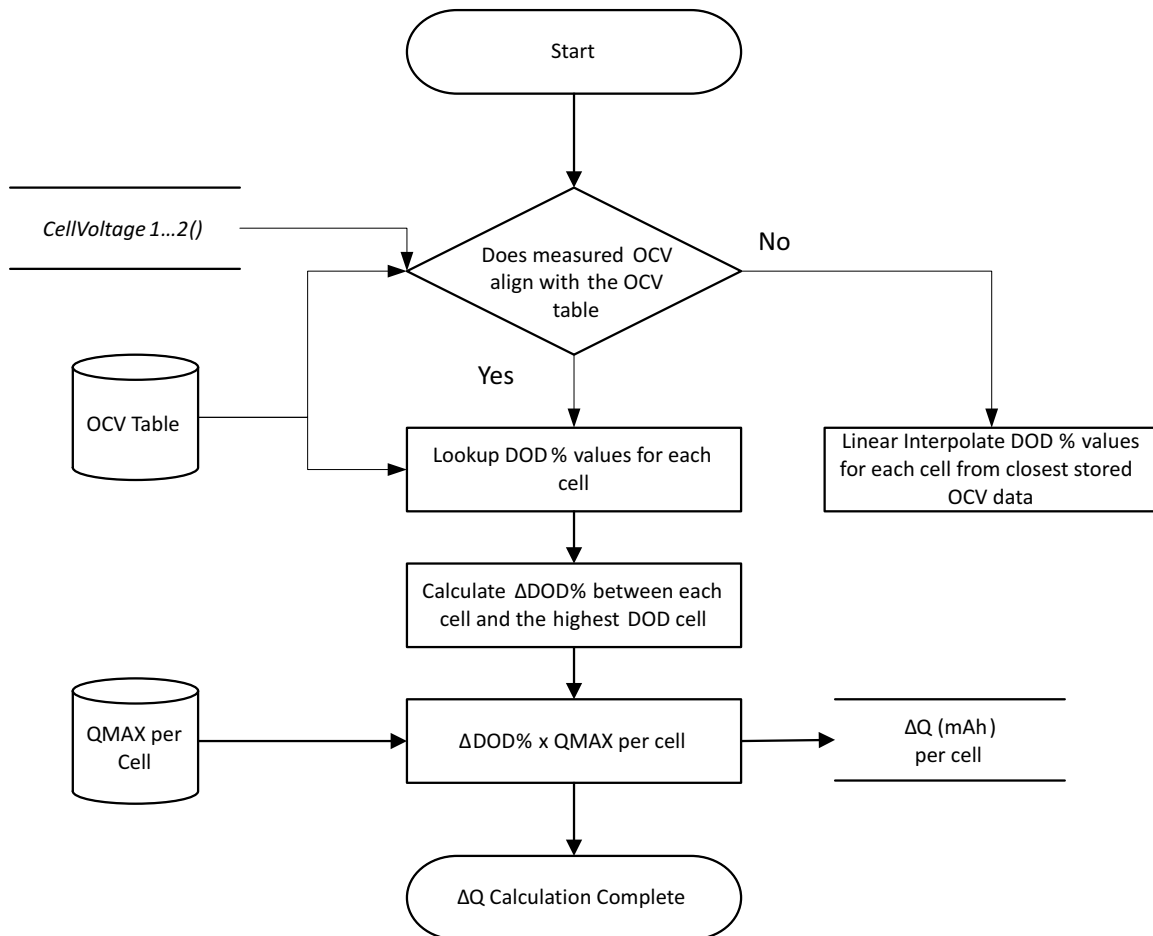

Figure 7-2. OCV Measurement

The BQ28Z610 then calculates the amount of charge difference between cells with a higher state-of-charge than the lowest cell SOC. The value, dQ, is determined for each cell based by converting the measured OCV to Depth-of-Discharge (DOD) percentages using a temperature-compensated DOD vs. OCV table lookup table. If the measured, OCV does not coincide with a specific table entry, then the DOD value is linearly interpolated from the two adjacent DODs of the respective table adjacent OCVs.

The delta in DOD% between each cell and the cell of lowest SOC is multiplied by the respective cells QMax to create dQ: for example, $dQ = \text{CellInDOD} - \text{CellLOWEST_SOC DOD} \times \text{CellInQMax (mAh)}$.

Figure 7-3. ΔQ Calculation

The BQ28Z610 calculates the required balancing time using dQ and **Bal Time/mAh Cell 1** (for cell 1) or **Bal Time/mAh Cell 2**. The value of **Bal Time/mAh Cell 1** and **Bal Time/mAh Cell 2** is fixed based on key system factors and is calculated by:

$$\mathbf{Bal\ Time/mAh\ Cell\ x} = 3600 \text{ mAs} / (\text{DUTY} \times (1000 \text{ mV} / 1 \text{ V}) \times V_{\text{CELL}} / (R_{\text{VCx}} + R_{\text{cb}}))$$

Where:

V_{CELL} = average cell voltage (for example, 3.7 V for most chemistry)

R_{VCx} = external resistance in series between the cell and the pins of the BQ28Z610. In the reference schematic, $R_{\text{VC2}} = 105 \Omega$ and $R_{\text{VC1}} = 100 \Omega$.

R_{cb} = cell balancing FET R_{dson} , which is 150 Ω .

DUTY = cell balancing duty cycle, which is 68.75% typ.

Cell balancing time for each cell to be balanced is calculated by: $dQ_{\text{Cell}n} \times \mathbf{Bal\ Time/mAh\ Cell\ 1}$ for cell 1 or and $dQ_{\text{Cell}n} \times \mathbf{Bal\ Time/mAh\ Cell\ 2}$. The cell balancing time is stored in the 16-bit RAM register **CellBalanceTimer**, providing a maximum calculated time of 65535 s (or 18.2 hrs). This update only occurs if a valid QMax update has been made; otherwise, they are all set to 0.

The **CellBalanceTimer** registers are clamped at 0xFFFF and cannot roll over.

7.3 Cell Balancing Operation

Note: Cell balancing is called every 1 s.

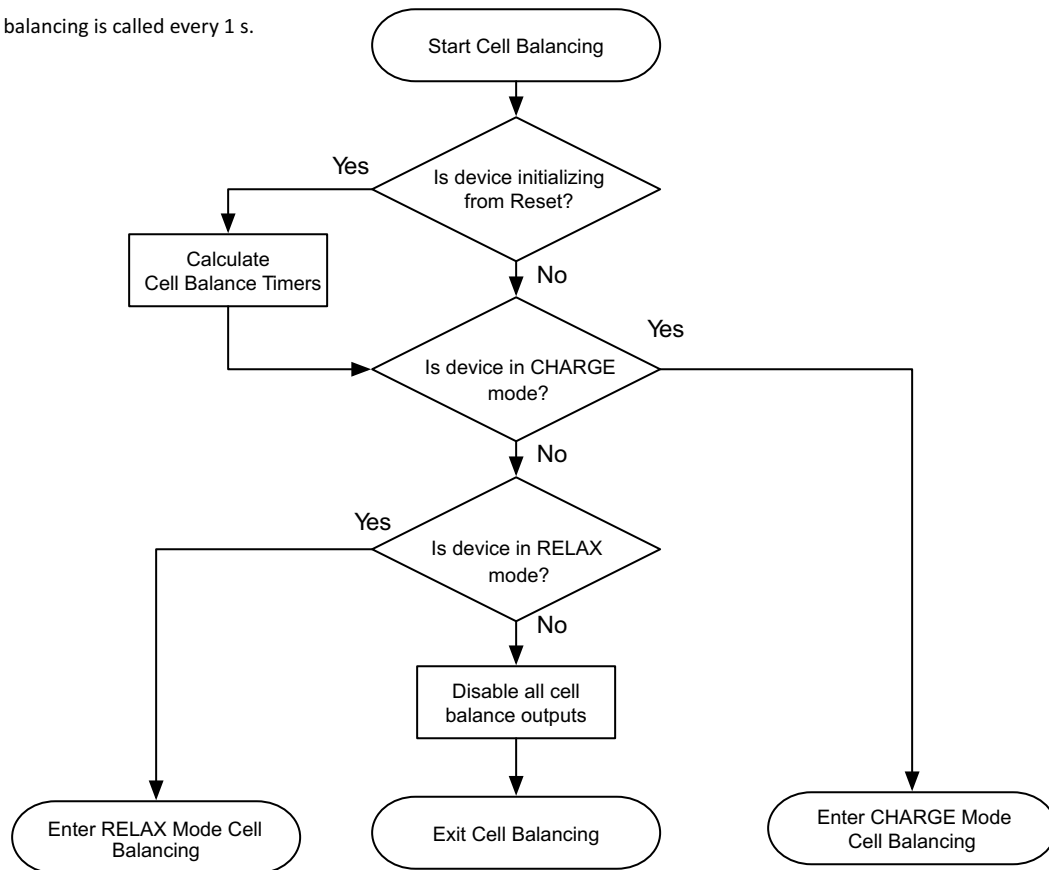

Figure 7-4. Cell Balance Mode Detection

The BQ28Z610 calls the cell balancing algorithm every 1 s during normal operation. Cell balancing is not called when the device is in SLEEP mode. All algorithm selections are made on this same 1-s timer.

In RELAX mode, if cell balancing at rest is enabled, **Balancing Configuration[CBR] = 1**. The gauge will verify if the dv/dt condition is met at the entry of the RELAX mode. If so, then the cell balancing at rest will start when all of the conditions below are met:

- Any pre-calculated Cell Balance Timer is non-zero AND
- **RelativeStateofCharge() > Min RSOC for Balancing**
The gauge will attempt to recalculate the cell balancing time in RELAX mode every **Relax Balance Interval**. The cell balancing time is updated if the conditions below are met:
 - The Relax Balance Interval has passed AND
 - A OCV measurement is taken AND
 - The max cell voltage delta > **Min Start Balance Delta**

On exit of the RELAX mode, cell balancing time is recalculated as long as a valid OCV update is available.

NOTE: Cell balancing is paused during OCV measurement.

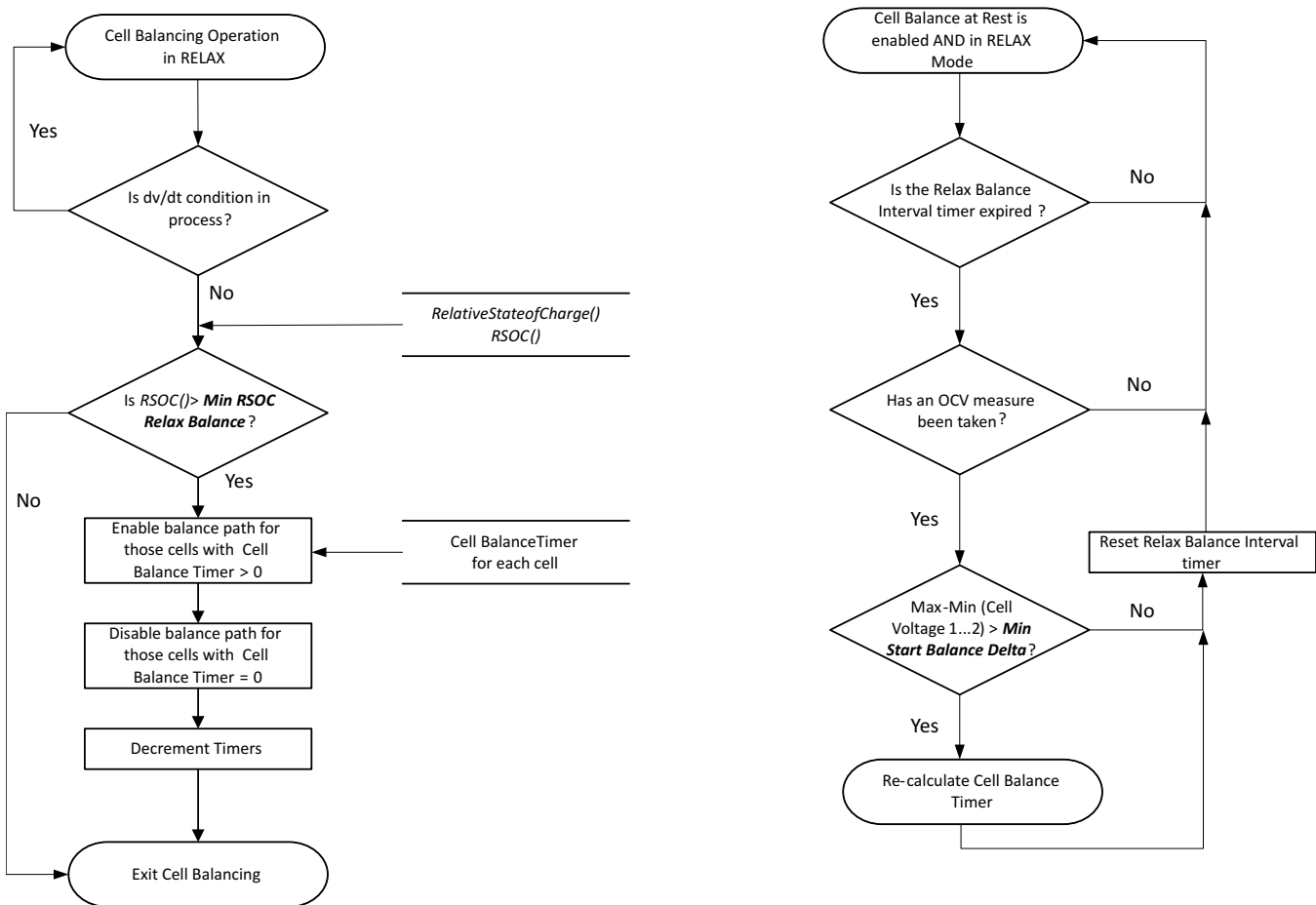

Figure 7-5. Cell Balance Operation in RELAX Mode

When the BQ28Z610 is in CHARGE mode, it follows these steps during cell balancing:

- a. Check if any of the precalculated Cell Balance Timers are > 0.
- b. The cell balance FETs are turned ON for the corresponding cell balance timers that are ≠ 0.

NOTE: There are no SOC restrictions controlling the enabling of cell balancing in CHARGE mode.

Note: Cell balancing is called every 1 s so this loop will execute every 1 s as long as the appropriate conditions exist.

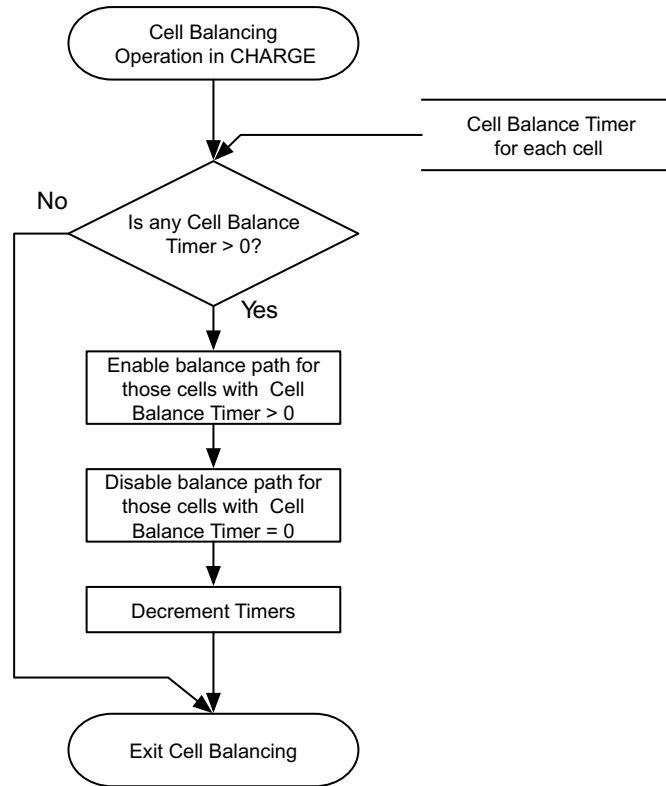

Figure 7-6. Cell Balance Operation in CHARGE Mode

Lifetime Data Collection

8.1 Description

The device has extensive capabilities for logging events over the life of the battery, which is useful for analysis. The Lifetime data collection is enabled by setting **ManufacturingStatus[LF_EN]** = 1. The data is collected in RAM and only written to DF under the following conditions to avoid wear out of the data flash:

- Every 10 hours if RAM content is different from flash.
- In permanent fail, before data flash updates are disabled.
- A reset counter increments
- The *LifetimeDataFlush* MAC command is received.

The lifetime data stops collecting under following conditions:

- After permanent fail
- Lifetime Data collection is disabled by setting **ManufacturingStatus[LF_EN]** = 0.

Total firmware runtime starts when lifetime data is enabled.

- Voltage
 - Max Cell Voltage for Each Cell
- Current
 - Max Charge/Discharge Current
- Temperature
 - Max/Min Cell Temp

Device Security

9.1 Description

There are three levels of secured operation within the device. To switch between the levels, different operations are needed with different keys. The three levels are SEALED, UNSEALED, and FULL ACCESS. The device also supports SHA-1 HMAC authentication with the host system.

9.2 SHA-1 Description

As of March 2012, the latest revision is FIPS 180-4. SHA-1, or secure hash algorithm, is used to compute a condensed representation of a message or data, also known as hash. For messages $< 2^{64}$, the SHA-1 algorithm produces a 160-bit output called a digest.

In a SHA-1 one-way hash function, there is no known mathematical method of computing the input given, only the output. The specification of SHA-1, as defined by FIPS 180-4, states that the input consists of 512-bit blocks with a total input length less than 264 bits. Inputs that do not conform to integer multiples of 512-bit blocks are padded before any block is input to the hash function. The SHA-1 algorithm outputs the 160-bit digest.

The device generates a SHA-1 input block of 288 bits (total input = 160-bit message + 128-bit key). To complete the 512-bit block size requirement of the SHA-1 function, the device pads the key and message with a 1, followed by 159 0s, followed by the 64 bit value for 288 (000...00100100000), which conforms to the pad requirements specified by FIPS 180-4.

Detailed information about the SHA-1 algorithm can be found here:

1. <http://www.nist.gov/itl/>
2. <http://csrc.nist.gov/publications/fips>
3. www.faqs.org/rfcs/rfc3174.html

9.3 HMAC Description

The SHA-1 engine calculates a modified HMAC value. Using a public message and a secret key, the HMAC output is considered to be a secure fingerprint that authenticates the device used to generate the HMAC.

To compute the HMAC: Let H designate the SHA-1 hash function, M designate the message transmitted to the device, and KD designate the unique 128-bit Unseal/Full Access/Authentication key of the device. HMAC(M) is defined as:

$H[KD || H(KD || M)]$, where || symbolizes an append operation.

The message, M, is appended to the unseal/full access/authentication key, KD, and padded to become the input to the SHA-1 hash. The output of this first calculation is then appended to the unseal/full access/authentication key, KD, padded again, and cycled through the SHA-1 hash a second time. The output is the HMAC digest value.

9.4 Authentication

The authentication should be implemented using the following steps:

1. MAC command 0x0000: Command = 0x0000, write the 20 bytes to 0x40, then write the checksum+len at 0x60.
The response will be available as a MAC response, so 0x3E/0x3F will be 0x0000, 0x40 will have the SHA1 result, and 0x60/0x61 will have the checksum and length.
2. Generate 160-bit message M using a random number generator that meets approved random number generators described in FIPS PUB 140–2.
3. Generate SHA-1 input block B1 of 512 bytes (total input = 128-bit authentication key KD + 160-bit message M + 1 + 159 0s + 100100000).
4. Generate SHA-1 hash HMAC1 using B1.
5. Generate SHA-1 input block B2 of 512 bytes (total input = 128-bit authentication key KD + 160-bit hash HMAC1 + 1 + 159 0s + 100100000).
6. Generate SHA-1 hash HMAC2 using B2.
7. With no active *MACData()* data waiting, write 160-bit message M to *MACData()* in the format 0xAABBCCDDEEFFGGHHIIJJKKLLMMNNOOPPQQRRSSTT, where AA is LSB.
8. Wait 250 ms, then read *MACData()* for HMAC3.
9. Compare host HMAC2 with device HMAC3, and if it matches, both host and device have the same key KD and the device is authenticated.

9.5 Security Modes

Changing the security keys requires using the change MAC command; the code to unseal the device can be sent to 0x3E, 0x3F. The order of the data is in Little Endian. To change the keys, the write operations must be sent through *AltManufacturerAccess()* 0x3E, 0x3F with the *SecurityKey()* followed by the key information. Each parameter entry must be sent in Little Endian. The 0x3E write block should end after the "0xCD". The checksum and length are a second command starting at 0x60.

Example:

Changing the Unseal key to 0x0123, 0x4567 and the Full Access key to 0x89AB, 0xCDEF:

Write block: command = 0x3E, block = 0x35 + 0x00 + 0x23 + 0x01 + 0x67 + 0x45 + 0xAB + 0x89 + 0xEF + 0xCD + 1 byte for checksum + 1 byte for data length. Note: The checksum and length are a second command starting at 0x60.

Starting address 0x3E, data block (hex) is [35 00 23 01 67 45 ab 89 EF CD], then starting address 0x60, data block (hex) is [0A 0C] (checksum followed by length) Checksum = 0x0A = ~(0x35 + 0x00 + 0x23 + 0x01 + 0x67 + 0x45 + 0xAB + 0x89 + 0xEF + 0xCD). The final checksum is the bitwise inversion of the result.

Byte0: Unseal Key LSB
 Byte1: Unseal Key MSB
 Byte2: Full Access Key LSB
 Byte3: Full Access Key MSB

For this activity, the 2nd key must be sent within 4 s of sending the first key; otherwise, the request will not be accepted.

9.5.1 SEALING and UNSEALING Data Flash

The gas gauge has a key access scheme to transition between SEALED, UNSEALED, and FULL ACCESS modes. Each transition requires that a unique set of two keys be sent to the gas gauge via the *AltManufacturerAccess()* command. The keys must be sent consecutively, with no other data being written to the *AltManufacturerAccess()* register. The *Seal Device* command instructs the device to limit access to the registers, functions, and data flash space, and sets the *[SEC1][SEC0]* flags. In SEALED mode, standard register information is accessible. Extended MAC Commands functions and data flash are not accessible. Once in SEALED mode, the part can never permanently return to UNSEALED or FULL ACCESS modes. Section 12.2.30, the *OperationStatus()* register, shows the status of the device using *[SEC1][SEC0]* bits.

9.5.2 SEALED to UNSEALED

SEALED to UNSEALED instructs the device to extend access to the standard and extended registers and data flash space and clears the *[SEC1][SEC0]* flags. In UNSEALED mode, all data, standard and extended registers and DF have read/write access. Unsealing is a two-step command performed by writing the first word of the unseal key to *AltManufacturerAccess()* (MAC), followed by the second word of the unseal key to *AltManufacturerAccess()*. The unseal key can be read and changed via the *MAC SecurityKey()* command when in FULL ACCESS mode. To return to the SEALED mode, either a hardware reset is needed, or the *MAC Seal Device()* command is needed to transit from FULL ACCESS or UNSEALED to SEALED.

9.5.3 UNSEALED to FULL ACCESS

UNSEALED to FULL ACCESS instructs the device to allow full access to all standard and extended registers and data flash. The device is shipped from TI in this mode. The keys for UNSEALED to FULL ACCESS can be read and changed via the MAC command *SecurityKey()* when in FULL ACCESS mode. Changing from UNSEALED to FULL ACCESS is performed by using the *AltManufacturerAccess()* command, by writing the first word of the Full Access Key to *AltManufacturerAccess()*, followed by the second word of the Full Access Key to *AltManufacturerAccess()*. In FULL ACCESS mode, the command to go to boot ROM can be sent.

Manufacture Production

10.1 Manufacture Testing

To improve the manufacture testing flow, the gas gauge device allows certain features to be toggled on or off through *AltManufacturerAccess()* commands. For example, the *CHG FET()*, *DSG FET()*, *Lifetime Data Collection()*, *Calibration()*, and so on. Enabling only the feature under test can simplify the test flow in production by avoiding any feature interference. These toggling commands will only set the RAM data, meaning the conditions set by these commands will be cleared if a reset or seal is issued to the gauge. The *ManufacturingStatus()* keeps track of the status (enabled or disabled) of each feature.

The data flash **Manufacturing Status** provides the option to enable or disable individual features for normal operation. Upon a reset or a seal command, *ManufacturingStatus()* will be reloaded from **Manufacturing Status**. This also means if an update is made to *ManufacturingStatus()* to enable or disable a feature, the gauge will only take the new setting if a reset or seal command is sent.

10.2 Calibration

The device has integrated routines that support calibration of current, voltage, and temperature readings, accessible after writing 0xF081 or 0xF082 to *AltManufacturerAccess()* when the *ManufacturingStatus()[CAL]* bit is ON. While the calibration is active, the raw ADC data is available on *MACData()*. The device stops reporting calibration data on *MACData()* if any other MAC commands are sent or the device is reset or sealed.

NOTE: The *ManufacturingStatus()[CAL]* bit must be turned OFF after calibration is completed. This bit is cleared at reset or after sealing.

Table 10-1. AltManufacturerAccess() Descriptions

AltManufacturerAccess()	Description
0x002D	Enables/Disables <i>ManufacturingStatus()[CAL]</i>
0xF080	Disables raw ADC data output on <i>MACData()</i>
0xF081	Outputs raw ADC data of voltage, current, and temperature on <i>MACData()</i>
0xF082	Outputs raw ADC data of voltage, current, and temperature on <i>MACData()</i> . This mode enables an internal short on the coulomb counter inputs (SRP, SRN).

The *MACData()* output format is: ZZYYaaAAabbBBccCCddDDeeEEffFFggGGhhHHiilJjJkkKK, where:

Table 10-2. MACData() Format Descriptions

Value	Format	Description
ZZ	byte	8-bit counter, increments when raw ADC values are refreshed (every 250 ms)
YY	byte	Output status <i>AltManufacturerAccess()</i> = 0xF081: 1 <i>AltManufacturerAccess()</i> = 0xF082: 2
AAaa	2's comp	Current (coulomb counter)
BBbb	2's comp	Cell Voltage 1
CCcc	2's comp	Cell Voltage 2

Table 10-2. MACData() Format Descriptions (continued)

Value	Format	Description
FFff	2's comp	BAT Voltage
GGgg	2's comp	PACK Voltage
HHhh	2's comp	Cell Current 1
Iiii	2's comp	Cell Current 2

Calibration

NOTE: All calibration steps that require accessing data on *MACData()* must begin read operations starting at *AltManufacturerAccess()* to ensure the data portion of the block is properly refreshed per the intended *AltManufacturerAccess()* subcommand (in this case 0xF081 or 0xF082). The first two bytes returned are the *AltManufacturerAccess()* subcommand followed by the counter, status, and raw ADC values, as shown in [Table 10-1](#).

11.1 Cell Voltage Calibration

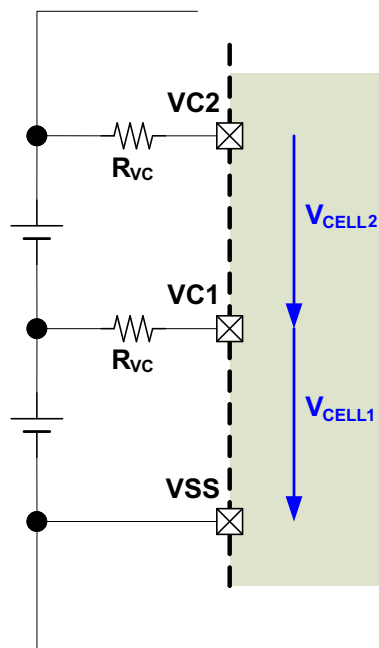

1. Apply known voltages in mV to the cell voltage inputs:
 - V_{CELL1} between VC1 terminal and VSS terminal
 - V_{CELL2} between VC2 terminal and VC1 terminal
2. If *ManufacturerStatus()[CAL] = 0*, send 0x002D to *AltManufacturerAccess()* to enable the [CAL] flag.
3. Send 0xF081 or 0xF082 to *AltManufacturerAccess()* to enable raw cell voltage output on *MACData()*.
4. Poll *MACData()* until the 8-bit counter value increments by 2 before reading data.
5. Read the ADC conversion readings of cell voltages from *MACData()*:
 - $ADC_{CELL1} = \text{AAaa of } MACData()$
 - $ADC_{CELL2} = \text{BBbb of } MACData()$
6. Average several readings for higher accuracy. Poll *MACData()* until ZZ increments, to indicate that updated values are available:
 - $ADC_{CELLx} = [ADC_{CELLx}(\text{reading } n) + \dots + ADC_{CELLx}(\text{reading } 1)]/n$

- Calculate gain value:

$$\text{Cell Gain} = \left\{ \left[\frac{V_{CELL1}}{ADC_{CELL1}} + \frac{V_{CELL2}}{ADC_{CELL2}} \right] \times 2^{16} \right\} / N \text{ where } N = \text{number of cells.}$$

- Write the new **Cell Gain** value to data flash.
- Recheck the voltage reading and if it is not accurate, repeat Steps 5 and 6.
- Send 0x002D to *AltManufacturerAccess()* to clear the [CAL] flag if all calibration is complete.

11.2 VC2 (BAT) Voltage Calibration

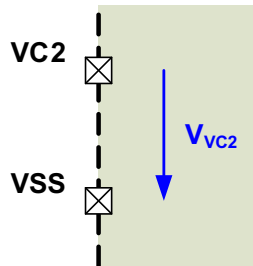

This device does not have a BAT terminal and therefore the VC2 input is the BAT terminal:

- Apply known voltages in mV to the voltage input:
 - V_{BAT} between VC2 terminal and VSS terminal
- If *ManufacturerStatus()[CAL]* = 0, send 0x002D to *AltManufacturerAccess()* to enable the [CAL] flag.
- Send 0xF081 or 0xF082 to *AltManufacturerAccess()* to enable raw cell voltage output on *MACData()*.
- Poll *MACData()* until the 8-bit counter value increments by 2 before reading data.
- Read ADC conversion readings of cell stack voltage from *MACData()*:
 - $ADC_{BAT} = \text{LLII of } MACData()$
- Average several readings for higher accuracy. Poll *MACData()* until ZZ increments to indicate that updated values are available:
 - $ADC_{BAT} = [ADC_{BAT}(\text{reading } n) + \dots + ADC_{BAT}(\text{reading } 1)]/n$
- Calculate gain value:

$$\text{BAT Gain} = \frac{V_{BAT}}{ADC_{BAT}} \times 2^{16}$$

- Write the new **BAT Gain** value to data flash.
- Recheck the voltage readings and if they are not accurate, repeat Steps 4 through 6.
- Send 0x002D to *AltManufacturerAccess()* to clear the [CAL] flag if all calibration is complete.

11.3 PACK Voltage Calibration

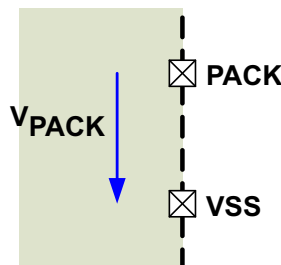

- Apply known voltages in mV to the voltage input:
 - V_{PACK} between PACK terminal and VSS terminal
- If *ManufacturerStatus()[CAL]* = 0, send 0x002D to *AltManufacturerAccess()* to enable the [CAL] flag.
- Send 0xF081 or 0xF082 to *AltManufacturerAccess()* to enable raw cell voltage output on *MACData()*.

4. Poll *MACData()* until the 8-bit counter value increments by 2 before reading data.
5. Read ADC conversion readings of pack voltage from *MACData()*:
 - $ADC_{PACK} = \text{KKkk of } MACData()$
6. Average several readings for higher accuracy. Poll *MACData()* until ZZ increments to indicate that updated values are available:
 - $ADC_{PACK} = [ADC_{PACK}(\text{reading } n) + \dots + ADC_{PACK}(\text{reading } 1)]/n$
7. Calculate gain value:

$$PACK \text{ Gain} = \frac{V_{PACK}}{ADC_{PACK}} \times 2^{16}$$
8. Write the new **PACK Gain** value to data flash.
9. Recheck voltage readings and if they are not accurate, repeat Steps 4 through 6.
10. Send 0x002D to *AltManufacturerAccess()* to clear the [CAL] flag if all calibration is complete.

11.4 Current Calibration

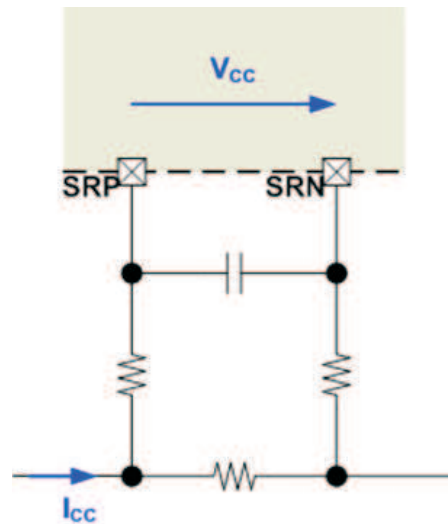

11.4.1 CC Offset Calibration

NOTE: Because of hardware improvements in this device, **CC Offset** Calibration is not necessary. Only run the **CC Offset** Calibration procedure if offset current is observed.

1. Apply a known current of 0 mA, and ensure no current is flowing through the sense resistor connected between the SRP and SRN pins.
2. If *ManufacturerStatus()[CAL] = 0*, send 0x002D to *AltManufacturerAccess()* to enable the [CAL] flag.
3. Send 0xF082 to *AltManufacturerAccess()* to enable raw cell voltage output on *MACData()*.
4. Poll *MACData()* until ZZ increments by 2 before reading data.
5. Obtain the ADC conversion readings of current from *MACData()*:
 - $ADC_{CC} = \text{AAaa of } MACData()$
 - Is $ADC_{CC} < 0x8000$? If yes, use ADC_{CC} ; otherwise, $ADC_{CC} = -(0xFFFF - \text{AAaa} + 0x0001)$.
6. Average several readings for higher accuracy. Poll *MACData()* until ZZ increments to indicate that updated values are available:
 - $ADC_{CC} = [ADC_{CC}(\text{reading } n) + \dots + ADC_{CC}(\text{reading } 1)]/n$
7. Read *Coulomb Counter Offset Samples* from data flash.

8. Calculate offset value:
 - **CC Offset** = $ADC_{CC} \times (\text{Coulomb Counter Offset Samples})$
9. Write the new **CC Offset** value to data flash.
10. Recheck the current reading and if it is not accurate, repeat the steps.
11. Send 0x002D to *AltManufacturerAccess()* to clear the [CAL] flag if all calibration is complete.

11.4.2 Board Offset Calibration

NOTE: Because of hardware improvements in this device, Board Offset Calibration is not necessary. Only run the Board Offset Calibration procedure if board offset current is observed.

1. Ensure that Offset Calibration was performed first.
2. Apply a known current of 0 mA, and ensure no current is flowing through the sense resistor connected between the SRP and SRN pins.
3. If *ManufacturerStatus()[CAL]* = 0, send 0x002D to *AltManufacturerAccess()* to enable the [CAL] flag.
4. Send 0xF081 to *AltManufacturerAccess()* to enable raw cell voltage output on *MACData()*.
5. Poll *MACData()* until ZZ increments by 2 before reading data.
6. Obtain the ADC conversion readings of current from *MACData()*:
 - $ADC_{CC} = \text{AAaa of } MACData()$
Is $ADC_{CC} < 0x8000$? If yes, use ADC_{CC} ; otherwise, $ADC_{CC} = -(0xFFFF - \text{AAaa} + 0x0001)$.
7. Average several readings for higher accuracy. Poll *MACData()* until ZZ increments to indicate that updated values are available:
 - $ADC_{CC} = [ADC_{CC}(\text{reading } n) + \dots + ADC_{CC}(\text{reading } 1)]/n$
8. Read *Coulomb Counter Offset Samples* from data flash.
9. Calculate offset value:
 - Board offset = $(ADC_{CC} \times \text{Coulomb Counter Offset Samples}) - \text{CC Offset}$
10. Write the new *Board Offset* value to data flash.
11. Recheck the current reading. If the reading is not accurate, repeat the steps.
12. Send 0x002D to *AltManufacturerAccess()* to clear the [CAL] flag if all calibration is complete.

11.4.3 CC Gain/Capacity Gain Calibration

1. Apply a known current (typically 1 A to 2 A), and ensure I_{CC} is flowing through the sense resistor connected between the SRP and SRN pins.
2. If *ManufacturerStatus()[CAL]* = 0, send 0x002D to *AltManufacturerAccess()* to enable the [CAL] flag.
3. Send 0xF081 to *AltManufacturerAccess()* to enable raw CC output on *MACData()*.
4. Poll *MACData()* until ZZ increments by 2 before reading data.
5. Check the ADC conversion current output from *MACData()*:
 - $ADC_{CC} = \text{AAaa of } MACData()$
Is $ADC_{CC} < 0x8000$? If yes, use ADC_{CC} ; otherwise, $ADC_{CC} = -(0xFFFF - \text{AAaa} + 0x0001)$.
6. Average several readings for higher accuracy. Poll *MACData()* until ZZ increments to indicate that updated values are available:
 - $ADC_{CC} = [ADC_{CC}(\text{reading } n) + \dots + ADC_{CC}(\text{reading } 1)]/n$
7. Read **Coulomb Counter Offset Samples** from data flash.
8. Calculate gain values:

$$CC\ Gain = \frac{I_{CC}}{ADC_{CC} - \frac{Board\ Offset + CC\ Offset}{Coulomb\ Counter\ Offset\ Samples}}$$

$$Capacity\ Gain = CC\ Gain \times 298261.6178$$

9. Write the new **CC Gain** and **Capacity Gain** values to data flash.
10. Recheck the current reading. If the reading is not accurate, repeat the steps.
11. Send 0x002D to `AltManufacturerAccess()` to clear the [CAL] flag if all calibration is complete.

11.5 Temperature Calibration

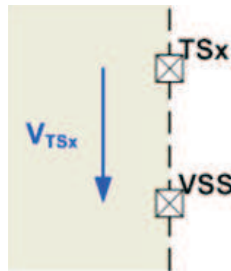

11.5.1 Internal Temperature Sensor Calibration

1. Apply a known temperature in 0.1°C, and ensure that temperature $TEMP_{TINT}$ is applied to the device.
2. Read the $TINT\ offset_{old}$ from **Internal Temp Offset**.
3. Read the reported temperature from `DAStatus2()`:
 - $TINT = AAaa$ of `DAStatus2()`
 Is $TINT > 0$? If yes, $TINT = AAaa - 2732$.
4. Calculate temperature offset:

$$TINT\ offset = TEMP_{TINT} - TINT + TINT\ offset_{old}$$

5. Write the new **Internal Temp Offset** value to data flash.
6. Recheck the `DAStatus2()` reading. If the reading is not accurate, repeat the steps.

11.5.2 TS1 Calibration

1. Apply a known temperature in 0.1°C, and ensure that temperature $TEMP_{TSx}$ is applied to the thermistor connected to the TSx terminal. "TSx" refers to TS1.
2. Read the $TSx\ offset_{old}$ from **External x Temp Offset**, where x is 1.
3. Read the appropriate temperature from the `DAStatus2()` block as TSx .
4. Calculate the temperature offset:

$$TSx\ offset = TEMP_{TSx} - TSx + TSx\ offset_{old}$$

where x is 1.

5. Write the new **External x Temp Offset** (where x is 1) value to data flash.
6. Recheck the `DAStatus2()` reading. If the reading is not accurate, repeat the steps.

I²C Commands

12.1 Standard Data Commands

To enable the system to read and write battery information, the BQ28Z610 uses a series of 2-byte standard I²C commands with a 7-bit device address of 0x55 (8 bits = 0xAA to write and 0xAB to read). Each standard command has an associated command code pair, as indicated in [Table 12-1, Standard Commands](#). Each protocol has specific means to access the data at each command code. Data RAM is updated and read by the gauge once per second.

Table 12-1. Standard Commands

Name	Register Code (LSB/MSB)	Description
<i>ManufacturerAccess/ControlStatus()</i>	CNTL 0x00/0x01	Control Register (see below)
<i>AtRate()</i>	AR 0x02/0x03	Read/Write. The value is a signed integer with the negative value indicating a discharge current value. The default value is 0 and forces <i>AtRateTimeToEmpty()</i> to return 65,535.
<i>AtRateTimeToEmpty()</i>	ARTTE 0x04/0x05	This read-only function returns an unsigned integer value to predict remaining operating time based on battery discharge at the <i>AtRate()</i> value in minutes with a range of 0 to 65,534. A value of 65,535 indicates <i>AtRate()</i> = 0. The gas gauge updates the <i>AtRateTimeToEmpty()</i> within 1 s after the system sets the <i>AtRate()</i> value. The gas gauge updates these parameters every 1 s. The commands are used in NORMAL mode.
<i>Temperature()</i>	TEMP 0x06/0x07	This read-only function returns an unsigned integer value of temperature in units (0.1 k) measured by the gas gauge, and is used for the gauging algorithm. It reports either <i>InternalTemperature()</i> or external thermistor temperature, depending on the setting of the [TEMPS] bit in Pack configuration.
<i>Voltage()</i>	VOLT 0x08/0x09	This read-only function returns an unsigned integer value of the measured cell pack in mV with a range of 0 12000 mV.
<i>BatteryStatus()</i>	FLAGS 0x0A/0x0B	See the Flags register.
<i>Current()</i>	INSTCURR 0x0C/0x0D	This read-only function returns a signed integer value that is the instantaneous current flow through the sense resistor. The value is updated every 1 s. Units are mA.
<i>RemainingCapacity()</i>	RM 0x10/0x11	This read-only command returns the predicted remaining capacity, based on rate (per configured Load Select), temperature, present depth-of-discharge, and stored impedance. Values are reported in mAh.
<i>FullChargeCapacity()</i>	FCC 0x12/0x13	This read-only command returns the predicted capacity of the battery at full charge, based on rate (per configured Load Select), temperature, present depth-of-discharge, and stored impedance. Values are reported in mAh.
<i>AverageCurrent</i>	AI 0x14/0x15	This read-only function returns a signed integer value that is the average current flow through the sense resistor. The value is updated every 1 s. Units are mA.
<i>AverageTimeToEmpty</i>	TTE 0x16/0x17	Uses average current value with a time constant of 15 s for this method. A value of 65535 means the battery is not being discharged.
<i>AverageTimeToFull</i>	TTF 0x18/0x19	This read-only function returns a signed integer value, predicting time to reach full charge for the battery in units of minutes based on <i>AverageCurrent()</i> . The computation accounts for the taper current time extension from linear TTF computation based on a fixed <i>AverageCurrent()</i> rate of charge accumulation. A value of 65,535 indicates the battery is not being charged.
<i>StandbyCurrent</i>	SI 0x1A/0x1B	This read-only function returns a signed integer value of measured standby current through the sense resistor. The <i>StandbyCurrent()</i> is an adaptive measurement. Initially it will report the standby current programmed in initial standby, and after several seconds in standby mode will report the measured standby. The register value is updated every 1 s when measured current is above the deadband and is less than or equal to 2 x initial standby. The first and last values that meet these criteria are not averaged in, since they may not be stable values. To approximate to a 1-min time constant, each new value of <i>StandbyCurrent()</i> is computed by taking approximate 93% weight of the last standby current and approximate 7% of the current measured average current.
<i>StandbyTimeToEmpty</i>	STTE 0x1C/0x1D	This read-only function returns a signed integer value, predicting remaining battery life at standby rate of discharge in units of minutes. The computation uses Nominal Available Capacity (NAC) for the calculation. A value of 65,535 indicates the battery is not being discharged.
<i>MaxLoadCurrent</i>	MLI 0x1E/0x1F	This read-only function returns a signed integer value in units of mA, of maximum load conditions. The <i>MaxLoadCurrent()</i> is an adaptive measurement which is initially reported as the maximum load current programmed in initial Max Load Current register. If the measured current is ever greater than the initial Max Load Current then the <i>MaxLoadCurrent()</i> updates to the new current. <i>MaxLoadCurrent()</i> is reduced to the average of the previous value and initial Max Load Current whenever the battery is charged to full after a previous discharge to an SOC of less than 50%. This will prevent the reported value from maintaining an unusually high value.
<i>MaxLoadTimeToEmpty</i>	MLTTE 0x20/0x21	This read-only function returns a signed integer value, predicting remaining battery life at the maximum discharge load current rate in units of minutes. A value of 65,535 indicates that the battery is not being discharged.

Table 12-1. Standard Commands (continued)

Name		Register Code (LSB/MSB)	Description
<i>AveragePower</i>	AP	0x22/0x23	This read-only function returns a signed integer value of average power during battery charging and discharging. It is negative during discharge and positive during charge. A value of 0 indicates that the battery is not being discharged. The value is reported in units of mW.
<i>BTPDischargeSet()</i>		0x24/0x25	This command sets the OperationStatusA [BTP_INT] and the BTP_INT pin will be asserted when the RemCap drops below the set threshold in DF register.
<i>BTPChargeSet()</i>		0x26/0x27	This command clears the OperationStatusA [BTP_INT] and the BTP_INT pin will be deasserted.
<i>InternalTemperature</i>	INT_TEMP	0x28/0x29	This read-only function returns an unsigned integer value of the measured internal temperature of the device in 0.1-k units measured by the gas gauge.
<i>CycleCount</i>	CC	0x2A/0x2B	This read-only function returns an unsigned integer value of the number of cycles the battery has experienced a discharge (range 0 to 65535). One cycle occurs when accumulated discharge greater than or equal to CC threshold.
<i>RelativeStateOfCharge</i>	SOC	0x2C/0x2D	This read-only function returns an unsigned integer value of the predicted remaining battery capacity expressed as percentage of <i>FullChargeCapacity()</i> with a range of 0% to 100%.
<i>StateOfHealth</i>	SOH	0x2E/0x2F	This read-only function returns an unsigned integer value expressed as a percentage of the ratio of predicted FCC (25C SoH Load Rate) over the <i>DesignCapacity()</i> . The range is 0x00 to 0x64 for 0% to 100%, respectively.
<i>ChargeVoltage</i>	CV	0x30/0x31	Returns the desired charging voltage in mV to the charger
<i>ChargeCurrent</i>	CC	0x32/0x33	Returns the desired charging current in mA to the charger
<i>DesignCapacity</i>		0x3C/0x3D	In SEALED and UNSEALED access: This command returns the value stored in Design Capacity and is expressed in mAh. This is intended to be a theoretical or nominal capacity of a new pack, but should have no bearing on the operation of the gas gauge functionality.
<i>AltManufacturerAccess</i>		0x3E/0x3F	MAC Data block command
<i>MACData</i>		0x40/0x5F	MAC Data block
<i>MACDataSum</i>		0x60	MAC Data block checksum
<i>MACDataLen</i>		0x61	MAC Data block length

12.1.1 0x00/01 ManufacturerAccess() Control

A read on this register returns the Control bits.

This Control Register is an I²C register, and the control bits are read back on register 0x00/0x01. These control bits are provided for backward compatibility/ease-of-use.

15	14	13	12	11	10	9	8	7	6	5	4	3	2	1	0
RSVD	SEC1	SEC0	AUTH CALM	RSVD	RSVD	Check Sum Valid	RSVD	BTP_INT	RSVD	RSVD	RSVD	LDMD	R_DIS	VOK	QMax

RSVD (Bit 15): Reserved

SEC1, SEC0 (Bits 14, 13): SECURITY Mode

- 0, 0 = Reserved
- 0, 1 = Full Access
- 1, 0 = Unsealed
- 1, 1 = Sealed

AUTHCALM (Bit 12): Automatic CALIBRATION mode

- 1 = Enabled
- 0 = Disabled

RSVD (Bits 11–10): Reserved

ChecksumValid (Bit 9): Checksum Valid

- 1 = Flash Writes are enabled.
- 0 = Flash Writes are disabled due to low voltage or PF condition.

RSVD (Bit 8): Reserved

BTP_INT (Bit 7): Battery Trip Point Interrupt. Setting and clearing this bit depends on various conditions. See [Section 6.8](#) for details.

RSVD (Bits 6–4): Reserved

LDMD (Bit 3): LOAD Mode

- 1 = Constant Power
- 0 = Constant Current

R_DIS (Bit 2): Resistance Updates

- 1 = Disabled
- 0 = Enabled

VOK (Bit 1): Voltage OK for QMax Update

- 1 = Detected
- 0 = Not Detected

QMax (Bit 0): QMax Updates. This bit toggles after every QMax update.

12.1.2 0x02/03 AtRate()

This read/write word function sets the value used in calculating *AtRateTimeToFull()* and *AtRateTimeToEmpty()*.

SBS Cmd	Name	Access			Proto- col	Type	Min	Max	Default	Unit
		SE	US	FA						
0x02/03	<i>AtRate()</i>		R/W		Word	I2	–32768	32767	0	mA

12.1.3 0x04/05 AtRateTimeToEmpty()

This read-word function returns the remaining time to fully discharge the battery stack.

SBS Cmd	Name	Access			Proto- col	Type	Min	Max	Unit	Note
		SE	US	FA						
0x04/05	<i>AtRateTimeToEmpty()</i>		R		Word	U2	0	65535	min	65535 indicates not being charged

12.1.4 0x06/07 Temperature()

This read-word function returns the temperature in units 0.1°K.

SBS Cmd	Name	Access			Proto- col	Type	Min	Max	Unit
		SE	US	FA					
0x06/07	<i>Temperature()</i>		R		Word	U2	0	65535	0.1°K

12.1.5 0x08/09 Voltage()

This read-word function returns the sum of the measured cell voltages.

SBS Cmd	Name	Access			Proto- col	Type	Min	Max	Unit
		SE	US	FA					
0x08/09	<i>Voltage()</i>		R		Word	U2	0	65535	mV

12.1.6 0x0A/0B BatteryStatus()

This read-word function returns various battery status information.

SBS Cmd	Name	Access			Protocol	Type	Min	Max	Note
		SE	US	FA					
0x0A	<i>BatteryStatus()</i>	R	R	R	Word	H2			Bit 3:0: EC3,EC2,EC1,EC0 Error Code 0x00 = OK 0x1 = Busy 0x2 = Reserved Command 0x3 = Unsupported Command 0x4 = AccessDenied 0x5 = Overflow/Underflow 0x6 = BadSize 0x7 = UnknownError Bit 4: FD—Fully Discharged 0 = Battery ok 1 = Battery fully depleted Bit 5: FC—Fully Charged 0 = Battery not fully charged 01 = Battery fully charged Bit 6: DSG—Discharging 0 = Battery is charging. 1 = Battery is discharging. Bit 7: INIT—Initialization 0 = Inactive 1 = Active Bit 8: RTA—Remaining Time Alarm 0 = Inactive 1 = Active
0x0B	<i>BatteryStatus()</i>	R	R	R	Word	H2			Bit 9: RCA—Remaining Capacity Alarm 0 = Inactive 1 = Active Bit 10: Reserved Undefined Bit 11: TDA—Terminate Discharge Alarm 0 = Inactive 1 = Active Bit 12: OTA—Overtemperature Alarm 0 = Inactive 1 = Active Bit 13: Reserved Undefined Bit 14: TCA—Terminate Charge Alarm 0 = Inactive 1 = Active Bit 15: OCA—Overcharged Alarm 0 = Inactive 1 = Active

12.1.7 0x0C/0D Current()

This read-word function returns the measured current from the coulomb counter.

SBS Cmd	Name	Access			Protocol	Type	Min	Max	Unit
		SE	US	FA					
0x0C/0D	<i>Current()</i>			R	Word	I2	-32767	32768	mA

12.1.8 0x0E/0F MaxError()

This read-word function returns the expected margin of error, in %, in the state-of-charge calculation with a range of 1 to 100%.

SBS Cmd	Name	Access			Protocol	Type	Min	Max	Unit
		SE	US	FA					
0x0E/0F	<i>MaxError()</i>			R	Word	U1	0	100	%

Condition	Action
Full device reset	<i>MaxError()</i> = 100%
RA-table only updated	<i>MaxError()</i> = 5%
QMax only updated	<i>MaxError()</i> = 3%
RA-table and QMax updated	<i>MaxError()</i> = 1%
Each <i>CycleCount()</i> increment after last valid QMax update	<i>MaxError()</i> increment by 0.05%

Condition	Action
The <i>Configuration:Max Error Time Cycle Equivalent</i> period passed since the last valid QMax update	<i>MaxError()</i> increment by 0.05%.

12.1.9 0x10/11 RemainingCapacity()

This read-word function returns the predicted remaining battery capacity.

SBS Cmd	Name	Access			Protocol	Type	Min	Max	Unit
		SE	US	FA					
0x10/11	<i>RemainingCapacity()</i>	R			Word	U2	0	65535	mAh

12.1.10 0x12/13 FullChargeCapacity()

This read-word function returns the predicted battery capacity when fully charged.

SBS Cmd	Name	Access			Protocol	Type	Min	Max	Unit
		SE	US	FA					
0x12/13	<i>FullChargeCapacity()</i>	R			Word	U2	0	65535	mAh

12.1.11 0x14/15 AverageCurrent()

SBS Cmd	Name	Access			Protocol	Type	Min	Max	Unit
		SE	US	FA					
0x14/15	<i>AverageCurrent()</i>	R			Word	I2	-32767	32768	mA

12.1.12 0x16/17 AverageTimeToEmpty()

This read-word function returns the predicted remaining battery capacity based on *AverageCurrent()*.

SBS Cmd	Name	Access			Protocol	Type	Min	Max	Unit	Note
		SE	US	FA						
0x16/17	<i>AverageTimeToEmpty()</i>	R			Word	U2	0	65535	min	65535 = Battery is not being discharged.

12.1.13 0x18/19 AverageTimeToFull()

This read-word function returns the predicted time to full charge based on *AverageCurrent()*.

SBS Cmd	Name	Access			Protocol	Type	Min	Max	Unit	Note
		SE	US	FA						
0x18/19	<i>AverageTimeToFull()</i>	R			Word	U2	0	65535	min	65535 = Battery is not being discharged.

12.1.14 0x1A/1B StandbyCurrent()

SBS Cmd	Name	Access			Protocol	Type	Min	Max	Unit
		SE	US	FA					
0x1A/1B	<i>StandbyCurrent()</i>	R			Word	I2	-32767	32768	mA

12.1.15 0x1C/1D StandbyTimeToEmpty()

This read-word function returns the predicted remaining battery capacity based on the minimum load rate of discharge.

SBS Cmd	Name	Access			Proto- col	Type	Min	Max	Unit	Note
		SE	US	FA						
0x1C/1D	<i>StandbyTimeToEmpty()</i>		R		Word	U2	0	65535	min	65535 = Battery is not being discharged.

12.1.16 0x1E/1F MaxLoadCurrent()

This read-word function returns the maximum load conditions based on adaptive measurements, using the values in the initial Max Load Current register and the measured Max Load Current.

SBS Cmd	Name	Access			Proto- col	Type	Min	Max	Unit
		SE	US	FA					
0x1E/1F	<i>MaxLoadCurrent()</i>		R		Word	I2	-32767	32768	mA

12.1.17 0x20/21 MaxLoadTimeToEmpty()

This read-word function returns the predicted remaining battery capacity based on the maximum load rate of discharge.

SBS Cmd	Name	Access			Proto- col	Type	Min	Max	Unit	Note
		SE	US	FA						
0x20/21	<i>MaxLoadTimeTimeToEmpty()</i>	R	R	R	Word	U2	0	65535	min	65535 = Battery is not being discharged.

12.1.18 0x22/23 AveragePower()

This read-word function returns the average power during battery charging or discharging. It is negative due to discharge and positive due to charge. A zero value indicates the battery is not being discharged.

SBS Cmd	Name	Access			Proto- col	Type	Min	Max	Unit
		SE	US	FA					
0x22/23	<i>AveragePower()</i>		R		Word	I2	-32767	32768	mW

12.1.19 0x24/25 BTPDischargeSet()

This read/write word command updates the BTP set threshold for DISCHARGE mode for the next BTP interrupt, deasserts the present BTP interrupt, and clears the *OperationStatus()*[BTP_INT] bit.

SBS Cmd	Name	Access			Proto- col	Type	Min	Max	Unit
		SE	US	FA					
0x24/25	<i>BTPDischargeSet()</i>	R/W	R/W	R/W	Word	I2	0	32767	mAh

12.1.20 0x26/27 BTPChargeSet()

The read/write word command updates the BTP set threshold for CHARGE mode for the next BTP interrupt, deasserts the present BTP interrupt, and clears the *OperationStatus()*[BTP_INT] bit.

SBS Cmd	Name	Access			Proto- col	Type	Min	Max	Unit
		SE	US	FA					
0x26/27	<i>BTPChargeSet()</i>	R/W	R/W	R/W	Word	I2	0	32767	mAh

12.1.21 0x28/29 InternalTemperature()

This read-word function returns the internal die temperature in units 0.1°K.

SBS Cmd	Name	Access			Proto- col	Type	Min	Max	Unit
		SE	US	FA					
0x28/29	<i>InternalTemperature()</i>	R			Word	U2	0	65535	0.1°K

12.1.22 0x2A/2B CycleCount()

This read-word function returns the number of discharge cycles the battery has experienced.

SBS Cmd	Name	Access			Proto- col	Type	Min	Max	Unit
		SE	US	FA					
0x2A/2B	<i>CycleCount()</i>	R	R/W	R/W	Word	U2	0	65535	cycles

12.1.23 0x2C/2D RelativeStateOfCharge()

This read-word function returns the predicted remaining battery capacity as a percentage of *FullChargeCapacity()*.

SBS Cmd	Name	Access			Proto- col	Type	Min	Max	Unit
		SE	US	FA					
0x2C/2D	<i>RelativeStateOfCharge()</i>	R			Word	U1	0	100	%

12.1.24 0x2E/2F State-of-Health (SOH)

This command returns the state-of-health (SOH) information of the battery in percentage of design capacity. It is a read-only command.

SBS Cmd	Name	Access			Proto- col	Type	Min	Max	Unit
		SE	US	FA					
0x2E/2F	<i>State-of-Health()</i>	R			Word	U1	0	100	%

12.1.25 0x30/31 ChargingVoltage()

This read-word function returns the desired charging voltage.

SBS Cmd	Name	Access			Proto- col	Type	Min	Max	Unit	Note
		SE	US	FA						
0x30/31	<i>ChargingVoltage()</i>	R	R	R	Word	U2	0	65535	mV	65535 = Request maximum voltage

12.1.26 0x32/33 ChargingCurrent()

This read-word function returns the desired charging current.

SBS Cmd	Name	Access			Proto- col	Type	Min	Max	Unit	Note
		SE	US	FA						
0x32/33	<i>ChargingCurrent()</i>	R	R	R	Word	U2	0	65535	mA	65535 = Request maximum current

12.1.27 0x3C/3D DesignCapacity()

This read-word function returns the theoretical maximum pack capacity.

SBS Cmd	Name	Access			Proto- col	Type	Min	Max	Default	Unit
		SE	US	FA						
0x3C/3D	<i>DesignCapacity()</i>	R	R/W	R/W	Word	U2	0	65535	4400	mAh
									6336	

12.1.28 0x3E/3F AltManufacturerAccess()

Writes to this command are interchangeable with *AltManufacturerAccess()*. This command is provided to enable an easy way to verify the active MAC command while reading the *MACData()* returned by the MAC. The host may simply read from *AltManufacturerAccess()* to *MACDataLength()* with one block read. For a description of returned data values, see the *AltManufacturerAccess()* version of same command in [Section 12.2](#).

SBS Cmd	Name	Access			Protocol	Type	Min	Max	Default	Unit
		SE	US	FA						
0x3E/3F	<i>MACBlockDataCommand()</i>	R	R	R	Word	—	—	—	—	—

12.1.29 0x40/0x5F MACData()

This is the data block for *AltManufacturerAccess()* or *AltManufacturerAccess()* commands.

SBS Cmd	Name	Access			Protocol	Type	Min	Max	Default	Unit
		SE	US	FA						
0x40/5F	<i>MACData ()</i>	R	R	R	Block	—	—	—	—	—

12.1.30 0x60 MACDataChecksum()

This is the checksum of the *AltManufacturerAccess()* and *MACData()* bytes.

SBS Cmd	Name	Access			Protocol	Type	Min	Max	Default	Unit	Note
		SE	US	FA							
0x60	<i>MACDataCheckSum ()</i>	R	R	R	Byte	—	—	—	—	—	

The checksum is the 8-bit sum of the MSB and LSB of the command plus the (command length) bytes in the buffer. The final sum is the bitwise inversion of the result. Since the length is part of the checksum, the verification cannot take place until the length is written. The checksum and length must be written together as a word to be valid.

12.1.31 0x61 MACDataLength()

This is the length for *AltManufacturerAccess()* and *MACData()*.

SBS Cmd	Name	Access			Protocol	Type	Min	Max	Default	Unit	Note
		SE	US	FA							
0x61	<i>MACDataLength()</i>	R	R	R	Byte	—	—	—	—	—	

The length byte for all MAC commands will include the 2-byte command, the 1-byte checksum, the 1-byte length, and 1 to 32 bytes of data. This means the minimum length value is 5 for a valid block (no length or checksum is used for command only writes, so block of zero size is not necessary). For proper write command validation, the checksum and length must be written in order (word access triggered).

12.2 0x00, 0x01 AltManufacturerAccess() and 0x3E, 0x3F AltManufacturerAccess()

AltManufacturerAccess() provides a method of reading and writing data in the Manufacturer Access System (MAC). The MAC command is sent via *AltManufacturerAccess()* by a block protocol. The result is returned on *AltManufacturerAccess()* via a block read.

Commands are set by writing to registers 0x00/0x01. On valid word access, the MAC command state is set, and commands 0x3E and 0x3F are used for MAC commands. These new addresses work the same as 0x00 and 0x01, but are primarily intended for block writes and reads.

Example: Send a MAC *Gauging()* to enable IT via *AltManufacturerAccess()*.

1. With Impedance Track disabled, send *Gauging()* (0x0021) to *AltManufacturerAccess()*
 - a. I²C Write, start address = 0x3E (or 0x00). Data = 21 00 (data must be sent in Little Endian).

2. IT is enabled, *ManufacturingStatus()[GAUGE_EN]* = 1.

Example: Read *Chemical ID()* (0x0006) via *AltManufacturerAccess()*.

1. Send *Chemical ID()* to *AltManufacturerAccess()*.
 - a. I²C Write, start address = 0x3E (or 0x00). Data sent = 06 00 (data must be sent in Little Endian).
2. Read the result from *AltManufacturerAccess()* and *MfgMACData()*.
 - a. I²C Read, start address = 0x3E length = 36 bytes. First 4 bytes of the response will be 06 00 10 12.
 - b. The first two bytes "06 00" is the MAC command (for verification).
 - c. The second two bytes "10 12" are the Chem ID in Little Endian. That is, 0x1210 for ChemID 1210.
 - d. The last two bytes of the 36-byte block will be the checksum and length. The length in this case will be 6. The checksum is 0xFF – (sum of the first length – 2 bytes). The length and checksum are used to validate the block response.

It is recommended to send “command only” operations to 0x00 and 0x01, and to set the command for a read back in the same way. The reason for this is that it can always reset any legacy support options that may be in effect; whereas, some legacy support options use 0x3E and 0x3F for other purposes. However, 0x3E and 0x3F can always safely be used for block reads. For backward compatibility, a request of the device number or version will report a value for read on 0x00/0x01. The response word for both MAC command DEV and VERSION (0x0001 and 0x0002) should report 0xFFA5 as the legacy response. This is meant as a token to indicate to the host that the real response is on the extended block. “Command only” operations take place immediately after the word write.

Table 12-2. AltManufacturerAccess() Command List

Command	Function	Access	Format	Data Read on MACData()	Not Available in SEALED Mode	Type	Units
0x0001	DeviceType	R	Block	√	—	hex	—
0x0002	FirmwareVersion	R	Block	√	—	hex	—
0x0003	HardwareVersion	R	Block	√	—	hex	—
0x0004	IFChecksum	R	Block	√	—	hex	—
0x0005	StaticDFSSignature	R	Block	√	—	hex	—
0x0006	ChemID	R	Block	√	—	hex	—
0x0007	Prev_MacWrite	R	Block	√	—	hex	—
0x0008	StaticChemDFSSignature	R	Block	√	—	hex	—
0x0009	AllDFSSignature	R	Block	√	—	hex	—
0x0010	ShutdownMode	W	—	—	—	hex	—
0x0011	SleepMode	W	—	—	—	hex	—
0x0012	Reset	W	—	—	—	hex	—
0x0013	Auto_CAL_MAC	W	—	—	—	hex	—
0x001F	ChargeFET	W	—	—	√	hex	—
0x0020	DischargeFET	W	—	—	√	hex	—
0x0021	Gauging (IT Enable)	W	—	—	√	hex	—
0x0022	FETControl	W	—	—	√	hex	—
0x0023	LifetimeDataCollection	W	—	—	√	hex	—
0x0024	PermanentFailure	W	—	—	√	hex	—
0x0028	LifetimeDataReset	W	—	—	√	hex	—
0x0029	PermanentFailureDataReset	W	—	—	√	hex	—
0x002D	CalibrationMode	W	—	—	√	hex	—
0x002E	LifetimeDataFlush	W	—	—	√	hex	—
0x002F	LifetimeDataTest	W	—	—	√	hex	—
0x0030	SealDevice	W	—	—	—	hex	—
0x0035	SecurityKeys	R/W	Block	√	√	hex	—
0x0037	AuthenticationKey	W	Block	—	√	hex	—
0x0041	Reset	W	—	—	—	hex	—
0x004A	Device Name	R/W	Block	√	—	hex	—
0x004B	Device Chem	R/W	Block	√	—	hex	—
0x004C	Manufacturer Name	R/W	Block	√	—	hex	—
0x004D	Manufacturer Date	R/W	Block	√	—	hex	—

Table 12-2. AltManufacturerAccess() Command List (continued)

Command	Function	Access	Format	Data Read on MACData()	Not Available in SEALED Mode	Type	Units
0x004E	Serial Number	R/W	—	√	—	hex	—
0x0050	SafetyAlert	R	Block	√	—	hex	—
0x0051	SafetyStatus	R	Block	√	—	hex	—
0x0052	PFAAlert	R	Block	√	—	hex	—
0x0053	PFStatus	R	Block	√	—	hex	—
0x0054	OperationStatus	R	Block	√	—	hex	—
0x0055	ChargingStatus	R	Block	√	—	hex	—
0x0056	GaugingStatus	R	Block	√	—	hex	—
0x0057	ManufacturingStatus	R	Block	√	—	hex	—
0x0058	AFERegister	R	Block	√	—	hex	—
0x0060	LifetimeDataBlock1	R	Block	√	—	Mixed	Mixed
0x0070	ManufacturerData	R	Block	√	—	hex	—
0x0071	DAStatus1	R	Block	√	—	Mixed	Mixed
0x0072	DAStatus2	R	Block	√	—	Mixed	Mixed
0x0073	ITStatus1	R	Block	√	—	Mixed	Mixed
0x0074	ITStatus2	R	Block	√	—	Mixed	Mixed
0x0075	ITStatus3	R	Block	√	—	Mixed	Mixed
0x0076	CB Status	R	Block	√	—	hex	—
0x0077	FCC_SOH	R	Block	√	—	hex	—
0x01yy	DFAccessRowAddress	R/W	Block	—	√	hex	—
0x0F00	ROMMode	W	—	—	√	hex	—
0xF080	ExitCalibrationOutput	R/W	Block	√	√	hex	—
0xF081	OutputCCandADCforCalibration	R/W	Block	√	√	hex	—
0xF082	OutputShortedCCandADC forCalibration	R/W	Block	√	√	hex	—

12.2.1 AltManufacturerAccess() 0x0001 Device Type

The device can be checked for the IC part number.

Status	Condition	Action
Enable	0x0001 to <i>AltManufacturerAccess()</i>	Returns the IC part number on subsequent read on <i>MACData()</i> in the following format: aaAA, where: aaAA: Device type

12.2.2 AltManufacturerAccess() 0x0002 Firmware Version

The device can be checked for the firmware version of the IC.

Status	Condition	Action
Enable	0x0002 to <i>AltManufacturerAccess()</i>	Returns the firmware revision on <i>MACData()</i> in the following format: ddDDvvVVbbBBttzzZZRRRE, where: ddDD: Device Number vvVV: Version bbBB: build number ttTT: Firmware type zzZZ: Impedance Track Version RR: Reserved EE: Reserved

12.2.3 AltManufacturerAccess() 0x0003 Hardware Version

The device can be checked for the hardware version of the IC.

Status	Condition	Action
Enable	0x0003 to <i>AltManufacturerAccess()</i>	Returns the hardware revision on subsequent read on <i>MACData()</i>

12.2.4 *AltManufacturerAccess() 0x0004 Instruction Flash Signature*

The device can return the instruction flash signature

Status	Condition	Action
Enable	0x0004 to <i>AltManufacturerAccess()</i>	Returns the IF signature on subsequent read on <i>MACData()</i> after a wait time of 250 ms

12.2.5 *AltManufacturerAccess() 0x0005 Static DF Signature*

The device can return the data flash checksum.

Status	Condition	Action
Enable	0x0005 to <i>AltManufacturerAccess()</i>	Returns the signature of all static DF on subsequent read on <i>MACData()</i> after a wait time of 250 ms. MSB is set to 1 if the calculated signature does not match the signature stored in DF.

12.2.6 *AltManufacturerAccess() 0x0006 Chemical ID*

This command returns the chemical ID of the OCV tables used in the gauging algorithm.

Status	Condition	Action
Enable	0x0006 to <i>AltManufacturerAccess()</i>	Returns the chemical ID on subsequent read on <i>MACData()</i>

12.2.7 *AltManufacturerAccess() 0x0007 Pre_MACWrite*

This command enables copying the last MAC into a 2-byte block.

Status	Condition	Action
Enable	0x0007 to <i>AltManufacturerAccess()</i>	Copies the last MAC information into a 2-byte block <i>MACData()</i>

12.2.8 *AltManufacturerAccess() 0x0008 Static Chem DF Signature*

The device can return the data flash checksum.

Status	Condition	Action
Enable	0x0008 to <i>AltManufacturerAccess()</i>	Returns the signature of all static chemistry DF on a subsequent read on <i>MACData()</i> after a wait time of 250 ms. MSB is set to 1 if the calculated signature does not match the signature stored in DF.

12.2.9 *AltManufacturerAccess() 0x0009 All DF Signature*

The device can return the data flash checksum.

Status	Condition	Action
Enable	0x0009 to <i>AltManufacturerAccess()</i>	Returns the signature of all DF parameters on a subsequent read on <i>MACData()</i> after a wait time of 250 ms. MSB is set to 1 if the calculated signature does not match the signature stored in DF. It is normally expected that this signature will change due to update of lifetime, gauging, and other information.

12.2.10 AltManufacturerAccess() 0x0010 SHUTDOWN Mode

The device can be sent to SHUTDOWN mode before shipping to reduce power consumption to a minimum. The device will wake up when a voltage is applied to PACK. When the pack is sealed, this feature requires the command be sent twice in a row for safety. Once SHUTDOWN mode is enabled, it is not possible to clear it without entering SHUTDOWN mode.

Status	Condition	Action
Normal	<i>OperationStatus()[SDM] = 0</i>	Shutdown feature is armed internally.
Arm	<i>OperationStatus()[SEC1,SEC0] = [1, 1]</i> <i>0x0010 sent to AltManufacturerAccess()</i>	Shutdown feature is armed internally.
Enable	<i>0x0010 to AltManufacturerAccess()</i> when <i>OperationStatus[SEC1,SEC0] = [1, 1]</i> OR <i>0x0010 to AltManufacturerAccess()</i> when shutdown feature is armed.	<i>OperationStatus()[SDM] = 1</i>
Trip	<i>Current() = 0</i> AND Voltage on PACK < Power. Charger Present AND <i>OperationStatus()[SDM] = 1</i>	No charging or discharging allowed. Device shutdown.
Recovery	Voltage on PACK terminal and device is in SHUTDOWN mode.	Device powers up (reset)

12.2.11 AltManufacturerAccess() 0x0011 SLEEP Mode

The device can be sent to SLEEP with *AltManufacturerAccess()* if the sleep conditions are met.

Status	Condition	Action
Enable	<i>0x0011 to AltManufacturerAccess()</i>	<i>OperationStatus()[SLEEPM] = 1</i>
Activate	$ Current() < \text{Power:Sleep Current}$	Turn off DSG FET Turn off CHG FET if DA Configuration[SLEEPCHG] = 0 Device goes to sleep Device wakes up every Power:Sleep Voltage Time period to measure voltage and temperature Device wakes up every Power:Sleep Current Time period to measure current
Exit	$ Current() > \text{Configuration:Sleep Current}$	<i>OperationStatus()[SLEEPM] = 0</i> Return to NORMAL mode
Exit	Wake Comparator trips	<i>OperationStatus()[SLEEPM] = 0</i> Return to NORMAL mode
Exit	<i>SafetyAlert()</i> flag or <i>PFAAlert()</i> flag set	<i>OperationStatus()[SLEEPM] = 0</i> Return to NORMAL mode

12.2.12 AltManufacturerAccess() 0x0012 Device Reset

This command resets the device.

Status	Condition	Action
Enable	<i>0x0012 to AltManufacturerAccess()</i>	Resets the device

NOTE: Command 0x0041 also resets the device.

12.2.13 AltManufacturerAccess() 0x001F CHG FET

This command turns on/off CHG FET drive function to ease testing during manufacturing.

Status	Condition	Action
Disable	<i>ManufacturingStatus()</i> [FET,CHG] = 0,1 AND 0x001F to <i>AltManufacturerAccess()</i>	<i>ManufacturingStatus()</i> [FET,CHG] = 0,0 CHG FET turns off
Enable	<i>ManufacturingStatus()</i> [FET,CHG] = 0,0 AND 0x001F to <i>AltManufacturerAccess()</i>	<i>ManufacturingStatus()</i> [FET,CHG] = 0,1 CHG FET turns on if no safety condition override.

12.2.14 AltManufacturerAccess() 0x0020 DSG FET

This command turns on/off DSG FET drive function to ease testing during manufacturing.

Status	Condition	Action
Disable	<i>ManufacturingStatus()</i> [FET,DSG] = 0,1 AND 0x0020 to <i>AltManufacturerAccess()</i>	<i>ManufacturingStatus()</i> [FET,DSG] = 0,0 DSG FET turns off <i>ManufacturingStatus()</i> [FET,DSG] = 0,0 AND 0x0020 to <i>AltManufacturerAccess()</i>
Enable		<i>ManufacturingStatus()</i> [FET,DSG] = 0,1 DSG FET turns on if no safety condition override.

12.2.15 AltManufacturerAccess() 0x0021 Gauging

This command enables or disables the gauging function to ease testing during manufacturing.

Status	Condition	Action
Disable	<i>ManufacturingStatus()</i> [Gauge] = 1 AND 0x0021 to <i>AltManufacturerAccess()</i>	<i>ManufacturingStatus()</i> [Gauge] = 0 Disables gauging feature
Enable	<i>ManufacturingStatus()</i> [Gauge] = 0 AND 0x0021 to <i>AltManufacturerAccess()</i>	<i>ManufacturingStatus()</i> [Gauge] = 1 Enable gauging feature

12.2.16 AltManufacturerAccess() 0x0022 FET Control

This command disables/enables control of the CHG, DSG, and PCHG FETs by the firmware.

Status	Condition	Action
Disable	<i>ManufacturingStatus()</i> [FET] = 1 AND 0x0022 to <i>AltManufacturerAccess()</i>	<i>ManufacturingStatus()</i> [FET] = 0 CHG and DSG FETs are disabled and remain OFF.
Enable	<i>ManufacturingStatus()</i> [FET] = 0 AND 0x0022 to <i>AltManufacturerAccess()</i>	<i>ManufacturingStatus()</i> [FET] = 1 CHG and DSG FETs are controlled by the firmware.

12.2.17 AltManufacturerAccess() 0x0023 Lifetime Data Collection

This command disables/enables Lifetime data collection for ease of manufacturing.

Status	Condition	Action
Disable	<i>ManufacturingStatus()</i> [LF] = 1 AND 0x0023 to <i>AltManufacturerAccess()</i>	<i>ManufacturingStatus()</i> [LF] = 0 Lifetime Data collection feature is disabled.
Enable	<i>ManufacturingStatus()</i> [LF] = 0 AND 0x0023 to <i>AltManufacturerAccess()</i>	<i>ManufacturingStatus()</i> [LF] = 1 Lifetime Data collection feature is enabled.

12.2.18 AltManufacturerAccess() 0x0024 Permanent Failure

This command disables/enables Permanent Failure for ease of manufacturing.

Status	Condition	Action
Disable	<i>ManufacturingStatus()</i> [PF] = 1 AND 0x0024 to <i>AltManufacturerAccess()</i>	<i>ManufacturingStatus()</i> [PF] = 0 Permanent Failure feature is disabled.
Enable	<i>ManufacturingStatus()</i> [PF] = 0 AND 0x0024 to <i>AltManufacturerAccess()</i>	<i>ManufacturingStatus()</i> [PF] = 1 Permanent Failure feature is enabled.

12.2.19 *AltManufacturerAccess()* 0x0028 Lifetime Data Reset

This command resets Lifetime data in data flash for ease of manufacturing.

Status	Condition	Action
Reset	0x0028 to <i>AltManufacturerAccess()</i>	Clears Lifetime Data in DF

12.2.20 *AltManufacturerAccess()* 0x0029 Permanent Fail Data Reset

This command resets PF data in data flash for ease of manufacturing.

Status	Condition	Action
Reset	0x0029 to <i>AltManufacturerAccess()</i>	Clears PF Data in DF

12.2.21 *AltManufacturerAccess()* 0x002D CALIBRATION Mode

This command disables/enables entry into CALIBRATION mode. Status is indicated by the *ManufacturingStatus()*[CAL] flag.

Status	Condition	Action
Disable	<i>ManufacturingStatus()</i> [CAL] = 1 AND 0x002D to <i>AltManufacturerAccess()</i>	<i>ManufacturingStatus()</i> [CAL] = 0 Disables output of ADC and CC raw data on <i>ManufacturingData()</i>
Enable	<i>ManufacturingStatus()</i> [CAL] = 0 AND 0x002D to <i>AltManufacturerAccess()</i>	<i>ManufacturingStatus()</i> [CAL] = 1 Enables output of ADC and CC raw data on <i>ManufacturingData()</i> , controllable with 0xF081 and 0xF082 on <i>AltManufacturerAccess()</i>

12.2.22 *AltManufacturerAccess()* 0x0030 Seal Device

This command seals the device for the field, disabling certain commands and access to DF.

Status	Condition	Action
Sealed	<i>OperationStatus()</i> [SEC1,SEC0] = 0,1 or 1,0 AND 0x0030 to <i>AltManufacturerAccess()</i>	<i>OperationStatus()</i> [SEC1,SEC0] = 1,1 Certain commands are not available. See Table 12-1 for details.

12.2.23 *AltManufacturerAccess()* 0x0035 Security Keys

This is a read/write command that changes the Unseal and Full Access keys. To read the keys, send the *SecurityKeys()* command to either the *AltManufacturerAccess()* 0x00 or 0x3E, followed by a read from *AltManufacturerAccess()*.

To change the keys, the write operations must be sent through *AltManufacturerAccess()* 0x3E with the *SecurityKeys()* followed by the keys. Each parameter entry must be sent in Little Endian.

Example:

Changing the Unseal key to 0x0123, 0x4567 and the Full Access key to 0x89AB, 0xCDEF:

Byte0: Unseal Key LSB
 Byte1: Unseal Key MSB
 Byte2: Full Access Key LSB
 Byte3: Full Access Key MSB

Write block: command through *AltManufacturerAccess()* starting address 0x3E, data block (hex) = [35 00 23 01 67 45 AB 89 EF CD].

Starting address 0x60, data block(hex) = [0A 0C] (checksum followed by length)

Checksum = 0x0A = $\sim(0x35 + 0x00 + 0x23 + 0x01 + 0x67 + 0x45 + 0xAB + 0x89 + 0xEF + 0xCD)$. The checksum is the 8-bit sum of the MSB and LSB of the command plus the (command length) bytes in the buffer. The final sum is the bitwise inversion of the result.

12.2.24 AltManufacturerAccess() 0x0037 Authentication Key

This command enters a new authentication key into the device.

Status	Condition	Action
Initiate	<i>OperationStatus()</i> [SEC1, SEC0] = 0,1 AND 0x0037 to <i>AltManufacturerAccess()</i>	<i>OperationStatus()</i> [AUTH] = 1 160-bit random number available at <i>MACData()</i>
Enter Key	Correct 128-bit Key written to <i>MACData()</i> in the format 0xAABBCCDDEEFFGGHHIIJJKKLLMMNNOOPP, where AA is LSB. In addition to this information, the checksum + length data block is required.	Wait time 250 ms <i>OperationStatus()</i> [AUTH] = 0 Device returns 160-bit HMAC digest at <i>MACData()</i> in the format: 0xAABBCCDDEEFFGGHHIIJJKKLLMMNNOOPPQQRRSSTTT, where AA is LSB. The HMAC digest was calculated using a challenge of all zeroes + key. The result can be used to verify the key without allowing a plain text read back.

12.2.25 AltManufacturerAccess() 0x0041 Device Reset

This command resets the device.

Status	Condition	Action
Enable	0x0041 to <i>AltManufacturerAccess()</i>	Reset the device

NOTE: Command 0x0012 also resets the device.

12.2.26 AltManufacturerAccess() 0x0050 SafetyAlert

This command returns the *SafetyAlert()* flags on *AltManufacturerAccess()* or *MACData()*.

Status	Condition	Action
Activate	0x0050 to <i>AltManufacturerAccess()</i>	Output <i>SafetyAlert()</i> flags on <i>MACData()</i>

31	30	29	28	27	26	25	24	23	22	21	20	19	18	17	16
RSVD	RSVD	RSVD	RSVD	UTD	UTC	RSVD	RSVD	RSVD	RSVD	CTOS	RSVD	PTOS	RSVD	RSVD	RSVD
15	14	13	12	11	10	9	8	7	6	5	4	3	2	1	0
RSVD	RSVD	OTD	OTC	RSVD	ASCD	RSVD	ASCC	RSVD	AOLD	RSVD	OCD	RSVD	OCC	COV	CUV

UTD (Bit 27): Undertemperature During Discharge

1 = Detected

0 = Not Detected

UTC (Bit 26): Undertemperature During Charge

- 1 = Detected
- 0 = Not Detected
- 0 = Not Detected

CTOS (Bit 21): Charge Timeout Suspend

- 1 = Detected
- 0 = Not Detected

PTOS (Bit 19): Precharge Timeout Suspend

- 1 = Detected
- 0 = Not Detected

OTD (Bit 13): Overtemperature During Discharge

- 1 = Detected
- 0 = Not Detected

OTC (Bit 12): Overtemperature During Charge

- 1 = Detected
- 0 = Not Detected

ASCD (Bit 10): Short-Circuit During Discharge

- 1 = Detected
- 0 = Not Detected

ASCC (Bit 8): Short-Circuit During Charge

- 1 = Detected
- 0 = Not Detected

AOLD (Bit 6): Overload During Discharge

- 1 = Detected
- 0 = Not Detected

OCD (Bit 4): Overcurrent During Discharge

- 1 = Detected
- 0 = Not Detected

OCC (Bit 2): Overcurrent During Charge

- 1 = Detected
- 0 = Not Detected

COV (Bit 1): Cell Overvoltage

- 1 = Detected
- 0 = Not Detected

CUV (Bit 0): Cell Undervoltage

- 1 = Detected
- 0 = Not Detected

12.2.27 *AltManufacturerAccess() 0x0051 SafetyStatus*

This command returns the *SafetyStatus()* flags on *MACData()*.

Status	Condition	Action
Activate	0x0051 to <i>AltManufacturerAccess()</i>	Outputs <i>SafetyStatus()</i> flags on <i>MACData()</i>

31	30	29	28	27	26	25	24	23	22	21	20	19	18	17	16
RSVD	RSVD	RSVD	RSVD	UTD	UTC	RSVD	RSVD	RSVD	RSVD	RSVD	CTO	RSVD	PTO	RSVD	RSVD
15	14	13	12	11	10	9	8	7	6	5	4	3	2	1	0
RSVD	RSVD	OTD	OTC	RSVD	ASCD	RSVD	ASCC	RSVD	AOLD	RSVD	OCD	RSVD	OCC	COV	CUV

UTD (Bit 27): Undertemperature During Discharge

1 = Detected

0 = Not Detected

UTC (Bit 26): Undertemperature During Charge

1 = Detected

0 = Not Detected

CTO (Bit 20): Charge Timeout

1 = Detected

0 = Not Detected

PTO (Bit 18): Precharge Timeout

1 = Detected

0 = Not Detected

OTD (Bit 13): Overtemperature During Discharge

1 = Detected

0 = Not Detected

OTC (Bit 12): Overtemperature During Charge

1 = Detected

0 = Not Detected

ASCD (Bit 10): Short-Circuit During Discharge

1 = Detected

0 = Not Detected

ASCC (Bit 8): Short-Circuit During Charge

1 = Detected

0 = Not Detected

AOLD (Bit 6): Overload During Discharge

1 = Detected

0 = Not Detected

OCD (Bit 4): Overcurrent During Discharge

1 = Detected

0 = Not Detected

OCC (Bit 2): Overcurrent During Charge

1 = Detected

0 = Not Detected

COV (Bit 1): Cell Overvoltage

1 = Detected

0 = Not Detected

CUV (Bit 0): Cell Undervoltage

1 = Detected

0 = Not Detected

12.2.28 AltManufacturerAccess() 0x0052 PFAAlert

This command returns the *PFAAlert()* flags on *MACData()*.

Status	Condition	Action
Activate	0x0052 to <i>AltManufacturerAccess()</i>	Outputs <i>PFAAlert()</i> flags on <i>MACData()</i>

31	30	29	28	27	26	25	24	23	22	21	20	19	18	17	16
RSVD	RSVD	RSVD	RSVD	RSVD	RSVD	RSVD	RSVD	RSVD	RSVD	RSVD	RSVD	RSVD	RSVD	DFET F	CFET F
15	14	13	12	11	10	9	8	7	6	5	4	3	2	1	0
RSVD	RSVD	RSVD	VIMA	VIMR	RSVD	RSVD	RSVD	RSVD	RSVD	RSVD	RSVD	RSVD	RSVD	SOV	RSVD

RSVD (Bits 31–18): Reserved

DFETF (Bit 17): Discharge FET Failure

1 = Detected

0 = Not Detected

CFETF (Bit 16): Charge FET Failure

1 = Detected

0 = Not Detected

RSVD (Bits 15–13): Reserved

VIMA (Bit 12): Voltage Imbalance While Pack Is Active Failure

1 = Detected

0 = Not Detected

VIMR (Bit 11): Voltage Imbalance While Pack Is At Rest Failure

1 = Detected

0 = Not Detected

RSVD (Bits 10–2): Reserved

SOV (Bit 1): Safety Cell Overvoltage Failure

1 = Detected

0 = Not Detected

RSVD (Bit 0): Reserved

12.2.29 AltManufacturerAccess() 0x0053 PFStatus

This command returns the *PFStatus()* flags on *MACData()*.

Status	Condition	Action
Activate	0x0053 to <i>AltManufacturerAccess()</i>	Outputs <i>PFStatus()</i> flags on <i>MACData()</i>

31	30	29	28	27	26	25	24	23	22	21	20	19	18	17	16
RSVD	RSVD	RSVD	RSVD	RSVD	RSVD	RSVD	RSVD	RSVD	RSVD	RSVD	RSVD	RSVD	RSVD	DFET F	CFET F
15	14	13	12	11	10	9	8	7	6	5	4	3	2	1	0
RSVD	RSVD	RSVD	VIMA	VIMR	RSVD	RSVD	RSVD	RSVD	RSVD	RSVD	RSVD	RSVD	RSVD	SOV	RSVD

RSVD (Bits 31–18): Reserved

DFETF (Bit 17): Discharge FET Failure

1 = Detected

0 = Not Detected

CFETF (Bit 16): Charge FET Failure

1 = Detected

0 = Not Detected

RSVD (Bits 15–13): Reserved

VIMR (Bit 12): Voltage Imbalance While Pack Is At Rest Failure

1 = Detected

0 = Not Detected

VIMA (Bit 11): Voltage Imbalance While Pack Is Active Failure

1 = Detected

0 = Not Detected

RSVD (Bits 10–2): Reserved

SOV (Bit 1): Safety Cell Overvoltage Failure

1 = Detected

0 = Not Detected

RSVD (Bit 0): Reserved

12.2.30 AltManufacturerAccess() 0x0054 OperationStatus

This command returns the *OperationStatus()* flags on *MACData()*.

Status	Condition	Action
Activate	0x0054 to <i>AltManufacturerAccess()</i>	Outputs <i>OperationStatus()</i> flags on <i>MACData()</i>

31	30	29	28	27	26	25	24	23	22	21	20	19	18	17	16
RSVD	RSVD	EM SHUT	CB	SLP CC	SLP AD	SMBL CAL	INIT	SLEE PM	XL	CAL OFF SET	CAL	AUTO CALM	AUTH	RSVD	SDM
15	14	13	12	11	10	9	8	7	6	5	4	3	2	1	0
SLEE P	SEC1	SEC0	PF	SS	SDV	SEC1	SEC0	BTP _INT	RSVD	RSVD	RSVD	RSVD	CHG	DSG	RSVD

RSVD (Bits 31–30): Reserved

EMSHUT (Bit 29): Emergency FET Shutdown

1 = Active

0 = Inactive

CB (Bit 28): Cell Balancing

1 = Active
0 = Inactive

SLPCC (Bit 27): CC Measurement in SLEEP mode

1 = Active
0 = Inactive

SLPAD (Bit 26): ADC Measurement in SLEEP mode

1 = Active
0 = Inactive

SMBLCAL (Bit 25): Auto-offset calibration when Bus low is detected.

1 = Active
0 = Inactive

INIT (Bit 24): Initialization after full reset

1 = Active
0 = Inactive

SLEEPM (Bit 23): SLEEP mode

1 = Active
0 = Inactive

XL (Bit 22): 400-kHz mode

1 = Active
0 = Inactive

CAL_OFFSET (Bit 21): Calibration Output (raw **CC Offset** data)

1 = Active when MAC *OutputShortedCCADCCal()* is sent and the raw shorted CC data for calibration is available.
0 = When the raw shorted CC data for calibration is not available.

CAL (Bit 20): Calibration Output (raw ADC and CC data)

1 = Active when either the MAC *OutputCCADCCal()* or *OutputShortedCCADCCal()* is sent and the raw CC and ADC data for calibration is available.
0 = When the raw CC and ADC data for calibration is not available.

AUTHCALM (Bit 19): Auto CC Offset Calibration by MAC *AutoCCOffset()*

1 = The gauge receives the MAC *AutoCCOffset()* and starts the auto CC Offset calibration.
0 = Clear when the calibration is completed.

AUTH (Bit 18): Authentication in progress

1 = Active
0 = Inactive

RSVD (Bit 17): Reserved

SDM (Bit 16): SHUTDOWN triggered via command

1 = Active
0 = Inactive

SLEEP (Bit 15): SLEEP mode conditions met

1 = Active
0 = Inactive

SEC1, SEC0 (Bits 14, 13): SECURITY Mode

0, 0 = Reserved
0, 1 = Full Access
1, 0 = Unsealed

1, 1 = Sealed

PF (Bit 12): PERMANENT FAILURE mode status

1 = Active

0 = Inactive

SS (Bit 11): SAFETY mode status

1 = Active

0 = Inactive

SDV (Bit 10): SHUTDOWN triggered via low pack voltage

1 = Active

0 = Inactive

SEC1, SEC0 (Bits 9–8): SECURITY mode

0, 0 = Reserved

0, 1 = Full Access

1, 0 = Unsealed

1, 1 = Sealed

BTP_INT (Bit 7): Battery Trip Point (BTP) Interrupt output

1 = Active

0 = Inactive

RSVD (Bits 6–3): Reserved

CHG (Bit 2): CHG FET status

1 = Active

0 = Inactive

DSG (Bit 1): DSG FET status

1 = Active

0 = Inactive

RSVD (Bit 0): Reserved

12.2.31 *AltManufacturerAccess() 0x0055 ChargingStatus*

This command returns the *ChargingStatus()* flags on *MACData()*.

Status	Condition	Action
Activate	0x0055 to <i>AltManufacturerAccess()</i>	Outputs <i>ChargingStatus()</i> flags on <i>MACData()</i>

15	14	13	12	11	10	9	8	7	6	5	4	3	2	1	0
VCT	MCHG	SU	IN	HV	MV	LV	PV	RSVD	OT	HT	STH	RT	STL	LT	UT

VCT (Bit 15): Charge Termination

1 = Active

0 = Inactive

MCHG (Bit 14): Maintenance Charge

1 = Active

0 = Inactive

SU (Bit 13): Charge Suspend

1 = Active

0 = Inactive

IN (Bit 12): Charge Inhibit

1 = Active

0 = Inactive

HV (Bit 11): High Voltage Region

1 = Active

0 = Inactive

MV (Bit 10): Mid Voltage Region

1 = Active

0 = Inactive

LV (Bit 9): Low Voltage Region

1 = Active

0 = Inactive

PV (Bit 8): Precharge Voltage Region

1 = Active

0 = Inactive

OT (Bit 6): Over Temperature Region

1 = Active

0 = Inactive

HT (Bit 5): High Temperature Region

1 = Active

0 = Inactive

STH (Bit 4): Standard Temperature High Region

1 = Active

0 = Inactive

RT (Bit 3): Room Temperature Region

1 = Active

0 = Inactive

STL (Bit 2): Standard Temperature Low Region

1 = Active

0 = Inactive

LT (Bit 1): Low Temperature Region

1 = Active

0 = Inactive

UT (Bit 0): Under Temperature Region

1 = Active

0 = Inactive

12.2.32 *AltManufacturerAccess()* 0x0056 *GaugingStatus*

This command returns the *GaugingStatus()* flags on *MACData()*.

NOTE: The [Battery Management Studio \(bqStudio\)](#) tool splits the returned value of *GaugingStatus()* into two separate registers: *GaugingStatus* = Lowest Byte, and *ITStatus* = 2nd and 3rd bytes, with the 4th byte reserved.

Status	Condition	Action
Activate	0x0056 to <i>AltManufacturerAccess()</i>	Outputs <i>GaugingStatus()</i> flags on <i>MACData()</i>

31	30	29	28	27	26	25	24	23	22	21	20	19	18	17	16
RSVD	RSVD	RSVD	RSVD	RSVD	RSVD	RSVD	RSVD	RSVD	RSVD	RSVD	OCV FR	LDMD	RX	QMax	VDQ
15	14	13	12	11	10	9	8	7	6	5	4	3	2	1	0
NSFM	RSVD	SLPQ Max	QEN	VOK	RDIS	RSVD	REST	CF	DSG	EDV	BAL_ EN	TC	TD	FC	FD

OCVFR (Bit 20): Open Circuit Voltage in Flat Region (during RELAX)

1 = Detected

0 = Not Detected

LDMD (Bit 19): LOAD mode

1 = Constant Power

0 = Constant Current

RX (Bit 18): Resistance Update (Toggles after every resistance update)

QMax (Bit 17): QMax Update (Toggles after every QMax update)

VDQ (Bit 16): Discharge Qualified for Learning (based on RU flag)

NSFM (Bit 15): Negative Scale Factor Mode

1 = Negative Ra Scaling Factor Detected

0 = Negative Ra Scaling Factor Not Detected

SLPQMax (Bit 13): QMax Update During Sleep

1 = Active

0 = Inactive

QEN (Bit 12): Impedance Track Gauging (Ra and QMax updates are enabled.)

1 = Enabled

0 = Disabled

VOK (Bit 11): Voltage OK for QMax Update

1 = Detected

0 = Not Detected

RDIS (Bit 10): Resistance Updates

1 = Disabled

0 = Enabled

REST (Bit 9): Rest

1 = OCV Reading Taken

0 = OCV Reading Not Taken or Not in Relax

1 = Detected

0 = Not Detected

CF (Bit 7): Condition Flag

1 = *MaxError()* > Max Error Limit (Condition Cycle is needed.)

0 = *MaxError()* < Max Error Limit (Condition Cycle is not needed.)

DSG (Bit 6): Discharge/Relax

1 = Charging Not Detected

0 = Charging Detected

- EDV (Bit 5):** End-of-Discharge Termination Voltage
1 = Termination voltage reached during discharge
0 = Termination voltage not reached or not in DISCHARGE mode
- BAL_EN (Bit 4):** Cell Balancing
1 = Cell balancing is possible if enabled.
0 = Cell balancing is not allowed.
- TC (Bit 3):** Terminate Charge
1 = Detected
0 = Not Detected
- TD (Bit 2):** Terminate Discharge
1 = Detected
0 = Not Detected
- FC (Bit 1):** Fully Charged
1 = Detected
0 = Not Detected
- FD (Bit 0):** Fully Discharged
1 = Detected
0 = Not Detected

12.2.33 *AltManufacturerAccess() 0x0057 ManufacturingStatus*

This command returns the *ManufacturingStatus()* flags on *MACData()*.

Status	Condition	Action
Activate	0x0057 to <i>AltManufacturerAccess()</i>	Outputs <i>ManufacturingStatus()</i> flags on <i>MACData()</i>

15	14	13	12	11	10	9	8
CAL_EN	RSVD	RSVD	RSVD	RSVD	RSVD	RSVD	RSVD
7	6	5	4	3	2	1	0
RSVD	PF_EN	LF_EN	FET_EN	GAUGE_EN	DSG_TEST	CHG_TEST	RSVD

CAL_EN (Bit 15): CALIBRATION Mode

- 1 = Enabled
0 = Disabled

RSVD (Bits 14–7): Reserved

PF_EN (Bit 6): Permanent Failure

- 1 = Enabled
0 = Disabled

LF_EN (Bit 5): Lifetime Data Collection

- 1 = Enabled
0 = Disabled

FET_EN (Bit 4): All FET Action

- 1 = Enabled
0 = Disabled

GAUGE_EN (Bit 3): Gas Gauging

1 = Enabled

0 = Disabled

DSG_TEST (Bit 2): Discharge FET Test

1 = Discharge FET test activated

0 = Disabled

CHG_TEST (Bit 1): Charge FET Test

1 = Charge FET test activated

0 = Disabled

RSVD (Bit 0): Reserved

12.2.34 *AltManufacturerAccess() 0x0058 AFE Register*

This command returns the *AFERegister()* values on *MACData()*. These are the AFE hardware registers and are intended for internal debug use only.

Status	Condition	Action
Activate	0x0058 to <i>AltManufacturerAccess()</i>	Output AFE Register values on <i>MACData()</i> in the following format: AABBCCDDEEFFGGHHIIJJKLLMMNNOOPPQQRRSSTTUU where: AA: AFE Interrupt Status. AFE Hardware interrupt status (for example, wake time, push-button, and so on) BB: AFE FET Status. AFE FET status (for example, CHG FET, DSG FET, input, and so on) CC: AFE RXIN. AFE I/O port input status DD: AFE Latch Status. AFE protection latch status EE: AFE Interrupt Enable. AFE interrupt control settings FF: AFE Control. AFE FET control enable setting GG: AFE RXIEN. AFE I/O input enable settings HH: II: JJ: KK: AFE Cell Balance. AFE cell balancing enable settings and status LL: AFE ADC/CC Control. AFE ADC/CC Control settings MM: AFE ADC Mux. AFE ADC channel selections NN: OO: AFE Control. AFE control on various HW based features PP: AFE Timer Control. AFE comparator and timer control QQ: AFE Protection. AFE protection delay time control RR: AFE OCD. AFE OCD settings SS: AFE SCC. AFE SCC settings TT: AFE SCD1. AFE SCD1 settings UU: AFE SCD2. AFE SCD2 settings

12.2.35 *AltManufacturerAccess() 0x0060 Lifetime Data Block 1*

This command returns the Lifetime data on *MACData()*.

Status	Condition	Action
Activate	0x0060 to <i>AltManufacturerAccess()</i>	Outputs lifetime data values of Voltage, Current, Power, and Temperature on <i>MACData()</i>

12.2.36 *AltManufacturerAccess() 0x0070 ManufacturerInfo*

This command returns *ManufacturerInfo* on *MACData()*.

Status	Condition	Action
Activate	0x0070 to <i>AltManufacturerAccess()</i>	Outputs 32 bytes of ManufacturerInfo on <i>MACData()</i> in the following format: AABBCDDDEEFFGGHHIIJJKKLLMMNN OOPPQQRRSSTTUUVVWWXXVZZ1 12233 445566

12.2.37 *AltManufacturerAccess() 0x0071 DAStatus1*

This command returns the CellVoltages, PackVoltage, BatVoltage, CellCurrents, CellPowers, Power, and AveragePower on *MACData()*.

Status	Condition	Action
Activate	0x0071 to <i>AltManufacturerAccess()</i>	Outputs 32 bytes of data on <i>MACData()</i> in the following format: aaAAAbbBBccCCddDDeeEEffFFggGGhhHHiiIjjJkkKKllLmmM MnnNNooOoppPP where: AAaa: Cell Voltage 1 BBbb: Cell Voltage 2 CCcc: DDdd: EEee: BAT Voltage. Voltage at the VC2 (BAT) terminal FFff: PACK Voltage GGgg: Cell Current 1. Simultaneous current measured during Cell Voltage1 measurement HHhh: Cell Current 2. Simultaneous current measured during Cell Voltage2 measurement Iiii: Jjji: Kkkk: Cell Power 1. Calculated using Cell Voltage1 and Cell Current 1 data Llll: Cell Power 2. Calculated using Cell Voltage2 and Cell Current 2 data Mmmm: Nnnn: Oooo: Power calculated by <i>Voltage() × Current()</i> Pppp: Average Power. Calculated by <i>Voltage() × AverageCurrent()</i>

12.2.38 *AltManufacturerAccess() 0x0072 DAStatus2*

This command returns the internal temp sensor, TS1*MACData()*.

Status	Condition	Action
Activate	0x0072 to <i>AltManufacturerAccess()</i>	Outputs 14 bytes of temperature data values on <i>MacData()</i> in the following format: aaAAAbbBBccCCddDDeeEEffFFggGG where: AAaa: Int Temperature BBbb: TS1 Temperature CCcc: DDdd: EEee: FFff: GGgg:

12.2.39 *AltManufacturerAccess() 0x0073 ITStatus1*

This command instructs the device to return Impedance Track related gauging information on *MACData()*.

Status	Condition	Action
Activate	0x0073 to <i>AltManufacturerAccess()</i>	Outputs 24 bytes of IT data values on <i>MACData()</i> in the following format: aaAAbbBBccCCddDDeeEEffFGgGGhhHHiiIjJkKkKILL where: AAaa: True Rem Q. True remaining capacity in mAh from IT simulation before any filtering or smoothing function. This value can be negative or higher than FCC. BBbb: True Rem E. True remaining energy in cWh from IT simulation before any filtering or smoothing function. This value can be negative or higher than FCC. CCcc: Initial Q. Initial capacity calculated from IT simulation DDdd: Initial E. Initial energy calculated from IT simulation EEee: TrueFullChgQ. True full charge capacity FFff: TrueFullChgE. True full charge energy GGgg: T_sim. Temperature during the last simulation run (in 0.1K) HHhh: T_ambient. Current estimated ambient temperature used by the IT algorithm for thermal modeling Iiii: RaScale 0. Ra table scaling factor of Cell1 Jjji: RaScale 1. Ra table scaling factor of Cell2 Kkkl: CompRes1. Last computed resistance for Cell1 LlIl: CompRes2. Last computed resistance for Cell2

12.2.40 *AltManufacturerAccess() 0x0074 ITStatus2*

This command instructs the device to return Impedance Track related gauging information on *MACData()*.

Status	Condition	Action
Activate	0x0074 to <i>AltManufacturerAccess()</i>	Outputs 24 bytes of IT data values on <i>MACData()</i> in the following format: AABBCDDDEEFFggGGhhHHiiIjJkKkKILLmmMMnnNNooOO where: AA: Pack Grid. Active pack grid point (only valid in discharge) BB: LStatus—Learned status of resistance table Bit 3 Bit 2 Bit 1 Bit 0 QMax ITEN CF1 CF0 CF1, CF0: QMax Status 0,0 = Battery OK 0,1 = QMax is first updated in learning cycle. 1,0 = QMax and resistance table updated in learning cycle ITEN: IT enable 0 = IT disabled 1 = IT enabled QMax: QMax field updates 0 = QMax is not updated in the field. 1 = QMax is updated in the field. CC: Cell Grid 1. Active grid point of Cell1 DD: Cell Grid 2. Active grid point of Cell2 EE: N/A. RSVD FF: N/A. RSVD HHhhGGgg: State Time. Time passed since last state change (Discharge, Charge, Rest) Iiii: DOD0_1. Depth of discharge for Cell1 Jjji: DOD0_2. Depth of discharge for Cell2 Kkkl: DOD0 Passed Q. Passed charge since DOD0 LlIl: DOD0 Passed Energy. Passed energy since the last DOD0 update Mmmm: DOD0 Time. Time passed since the last DOD0 update Nnnn: DODEOC_1. Cell 1 DOD@EOC Oooo: DODEOC_2. Cell 2 DOD@EOC

12.2.41 *AltManufacturerAccess() 0x0075 ITStatus3*

This command instructs the device to return Impedance Track related gauging information on *MACData()*.

Status	Condition	Action
Activate	0x0075 to <i>AltManufacturerAccess()</i>	Outputs 20 bytes of IT data values on <i>MACData()</i> in the following format: aaAAbbBBccCCddDDeeEEffFGgGhhHHiilJjJ where: AAaa: QMax 1. QMax of Cell 1 BBbb: QMax 2. QMax of Cell 2 CCcc: QMaxDOD0_1. Cell 1 DOD for Qmax DDdd: QMaxDOD0_2. Cell 2 DOD for Qmax EEee: QMaxPassedQ. Passed charge since DOD for Qmax recorded (mAh) FFff: QMaxTime. Time since DOD for Qmax recorded (hour / 16 units) GGgg: Tk. Thermal model "k" HHhh: Ta. Thermal model "a" Iiii: RawDOD0_1. Cell 1 raw DOD0 measurement JJjj: RawDOD0_2. Cell 2 raw DOD0 measurement

12.2.42 *AltManufacturerAccess()* 0x0076 CB Status

This command returns the status of the cell being balanced.

Status	Condition	Action
Enable	0x0076 to <i>AltManufacturerAccess()</i>	Outputs 10 bytes of IT data values on <i>MACData()</i> in the following format: aaAAbbBBccCCddDDeeEE AAaa: CBTime1. Cell 1 balance time remaining BBbb: CBTime2. Cell 2 balance time remaining CCcc: CBDOD_1. Cell 1 DOD when balance calculated DDdd: CBDOD_2. Cell 2 DOD when balance calculated EEee: CBTotalDODChg. Total DOD charge when balance calculated

12.2.43 *AltManufacturerAccess()* 0x0077 State-of-Health

This command returns the state-of-health percentage.

Status	Condition	Action
Enable	0x0077 to <i>AltManufacturerAccess()</i>	Returns the state-of-health percentage on subsequent read on <i>MACData()</i>

12.2.44 *AltManufacturerAccess()* 0x0F00 ROM Mode

This command sends the device into ROM mode in preparation for reprogramming.

Status	Condition	Action
ROM Mode	<i>OperationStatus()</i> [SEC1,SEC0] = 0,1 AND 0x0F00 to <i>AltManufacturerAccess()</i>	Device goes to ROM mode ready for update. ROM command 0x08 will return to firmware mode. (Note: ROM commands are sent to address 0x16 using SMB protocol.)

12.2.45 *Data Flash Access()* 0x4000–0x5FFF

Accessing data flash (DF) is only supported by the *AltManufacturerAccess()* by addressing the physical address.

To write to the DF, send the starting address, followed by the DF data block. The DF data block is the intended revised DF data to be updated to DF. The size of the DF data block ranges from 1 byte to 32 bytes. All individual data must be sent in Little Endian.

Write to DF example:

Assuming: data1 locates at address 0x4000 and data2 locates at address 0x4002.

Both data1 and data2 are U2 type.

To update data1 and data2, send a block write with command = 0x3E

block = starting address + DF data block

= 0x00 + 0x40 + data1_LowByte + data1_HighByte + data2_LowByte + data2_HighByte

To read the DF, send a block write to the *AltManufacturerAccess()*, followed by the starting address, then send a block read to the *AltManufacturerAccess()*. The return data contains the starting address followed by 32 bytes of DF data in Little Endian.

Read from DF example:

Taking the same assuming from the read DF example, to read DF:

a. Send the write block with command 0x3E, block = 0x00 + 0x40

b. Send the read block with command 0x3E

The returned block = a starting address + 32 bytes of DF dat

= 0x00 + 0x40 + data1_LowByte + data1_HighByte + data2_LowByte + data2_HighByte....

data32_LowByte + data32_HighByte

The gauge supports an auto-increment on the address during a DF read. This greatly reduces the time required to read out the entire DF. Continue with the read from the DF example. If another read block is sent with command 0x3E, the gauge returns another 32 bytes of DF data, starting with address 0x4020.

12.2.46 *AltManufacturerAccess() 0xF080 Exit Calibration Output Mode*

This command stops the output of calibration data to the *MACData()* command.

Status	Condition	Action
Activate	<i>MACData()</i> = 1 AND 0xF080 to <i>AltManufacturerAccess()</i>	Stops output of ADC or CC data on <i>MACData()</i>

12.2.47 *AltManufacturerAccess() 0xF081 Output CC and ADC for Calibration*

This command instructs the device to output the raw values for calibration purposes on *MACData()*. All values are updated every 250 ms and the format of each value is 2's complement, MSB first.

Status	Condition	Action
Disable	<i>ManufacturingStatus()[CAL]</i> = 1 AND 0xF080 to <i>AltManufacturerAccess()</i>	<i>ManufacturingStatus()[CAL]</i> = 0 Stops output of ADC and CC data on <i>MACData()</i>
Enable	0xF081 to <i>AltManufacturerAccess()</i>	<i>ManufacturingStatus()[CAL]</i> = 1 Outputs the raw CC and AD values on <i>MACData()</i> in the format of ZZYyaaAAbbBBccCCddDDeeEEffFF ggGGhhHHiiIjjJkkKK: ZZ: rolling 8-bit counter, increments when values are refreshed. YY: status, 1 when <i>AltManufacturerAccess()</i> = 0xF081, 2 when <i>AltManufacturerAccess()</i> = 0xF082 AAaa: Current (Coulomb Counter) BBaa: Cell Voltage 1 CCaa: Cell Voltage 2 DDaa: EEee: FFff:PACK Voltage GGgg: VC2 (BAT) Voltage HHhh: Cell Current 1 Iiii: Cell Current 2 JJjj: KKkk:

12.2.48 *AltManufacturerAccess() 0xF082 Output Shorted CC and ADC for Calibration*

This command instructs the device to output the raw values for calibration purposes on *AltManufacturerAccess()* or *MACData()*. All values are updated every 250 ms and the format of each value is 2's complement, MSB first. This mode includes an internal short on the coulomb counter inputs for measuring offset.

Status	Condition	Action
Disable	<i>ManufacturingStatus()[CAL] = 1 AND 0xF080 to AltManufacturerAccess()</i>	<i>ManufacturingStatus()[CAL] = 0</i> Stops output of ADC and CC data on <i>AltManufacturerAccess()</i> or <i>MACData()</i>
Enable	<i>0xF081 to AltManufacturerAccess()</i>	<i>ManufacturingStatus()[CAL] = 1</i> Outputs the raw CC and AD values on <i>AltManufacturerAccess()</i> or <i>MACData()</i> in the format of ZZYyaaAAAbbBBccCCddDDeeEEffFF ggGGhhHHiilljjJJkkKK: ZZ: rolling 8-bit counter, increments when values are refreshed. YY: status, 1 when <i>AltManufacturerAccess()</i> = 0xF081, 2 when <i>AltManufacturerAccess()</i> = 0xF082 AAaa: Current (Coulomb Counter) BBaa: Cell Voltage 1 CCaa: Cell Voltage 2 DDaa: EEee: FFff:PACK Voltage GGgg: VC2 (BAT) Voltage HHhh: Cell Current 1 Iiii: Cell Current 2 JJjj: KKkk:

Data Flash Values

13.1 Data Formats

13.1.1 Unsigned Integer

Unsigned integers are stored without changes as 1-byte, 2-byte, or 4-byte values in Little Endian byte order.

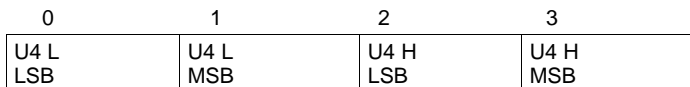
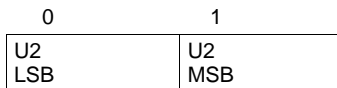
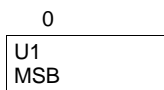

13.1.2 Integer

Integer values are stored in 2's-complement format in 1-byte, 2-byte, or 4-byte values in Little Endian byte order.

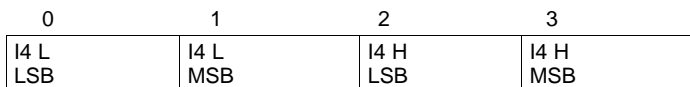
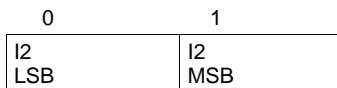
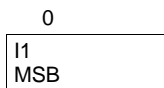

13.1.3 Floating Point

Floating point values are stored using the IEEE754 Single Precision 4-byte format in Little Endian byte order.

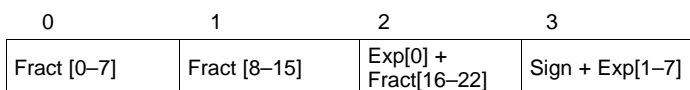

Where:

Exp: 8-bit exponent stored with an offset bias of 127. The values 00 and FF have special meaning.

Fract: 23-bit fraction. If the exponent is > 0, then the mantissa is 1.fract. If the exponent is zero, then the mantissa is 0.fract.

The floating point value depends on the special cases of the exponent:

- If the exponent is FF and the fraction is zero, this represents +/- infinity.
- If the exponent is FF and the fraction is non-zero this represents "not a number" (NaN).
- If the exponent is 00 then the value is a subnormal number represented by $(-1)^{\text{sign}} \times 2^{-126} \times 0.\text{fraction}$.
- Otherwise, the value is a normalized number represented by $(-1)^{\text{sign}} \times 2^{(\text{exponent} - 127)} \times 1.\text{fraction}$.

13.1.4 Hex

Bit register definitions are stored in unsigned integer format.

13.1.5 String

String values are stored with length byte first, followed by a number of data bytes defined with the length byte.

0	1	...	N
Length	Data0	...	DataN

13.2 Calibration

13.2.1 Voltage

Class	Subclass	Name	Type	Min	Max	Default	Unit	Description
Calibration	Voltage	Cell Gain	I2	-32768	32767	12101 ⁽¹⁾	—	VC[n]-VC[n-1] gain
Calibration	Voltage	PACK Gain	U2	0	65535	49669 ⁽¹⁾	—	PACK-VSS gain
Calibration	Voltage	VC2 (BAT) Gain	U2	0	65535	48936 ⁽¹⁾	—	VC2 (BAT)-VSS gain

⁽¹⁾ Setting this value to 0 causes the gauge to use the internal factory calibration default.

13.2.2 Current

Class	Subclass	Name	Type	Min	Max	Default	Description
Calibration	Current	CC Gain	F4	1.00E-001	4.00E+000	3.58422	Coulomb Counter Gain
Calibration	Current	Capacity Gain	F4	2.98E+004	1.19E+006	106903.5	Capacity Gain

13.2.3 Current Offset

Class	Subclass	Name	Type	Min	Max	Default	Unit	Description
Calibration	Current Offset	CC Offset	I2	-32768	32767	0	—	Coulomb Counter Offset
Calibration	Current Offset	Coulomb Counter Offset Samples	U2	0	65535	64	—	Coulomb Counter Offset Samples used for averaging
Calibration	Current Offset	Board Offset	I2	-32768	32767	0	—	PCB board offset

Class	Subclass	Name	Type	Min	Max	Default	Unit	Description
Calibration	Current Offset	CC Auto Config	H1	00	07	03	hex	Bit 0: AUTO_CAL_EN: Auto CC Offset calibration enable 0 = Disabled Auto CC calibration offset 1 = Firmware will perform auto CC calibration on entry into SLEEP mode. A min auto CC calibration interval is set to 10 hrs to prevent false wear out. The result is saved to CC Auto Offset . Bit 1: AUTO_NESTON: NEST Circuit ON 0 = HW NEST circuit is always on. Individual cell current measurement may have an error relative to <i>Current()</i> , but the <i>Current()</i> accuracy is not impacted. 1 = When [OFFSET_TAKEN] = 1, FW automatically controls the HW NEST circuit for best current and cell current measurements. Bit 2: OFFSET_TAKEN: CC Auto Offset is taken. 0 = CC Auto Offset has not been measured. 1 = CC Auto Offset has been measured. Bit 3 to Bit 7: Reserved
Calibration	Current Offset	CC Auto Offset	I2	-10000	10000	0		CC Offset collected via CC Auto Calibration . Used for cell current measurement and is different than CC Offset .

13.2.4 Current Deadband

Class	Subclass	Name	Type	Min	Max	Default	Unit	Description
Calibration	Current Deadband	Deadband	U1	0	255	3	mA	Pack-based deadband to report 0 mA
Calibration	Current Deadband	Coulomb Counter Deadband	U1	0	255	9	116 nV	Coulomb counter deadband to report 0 charge (This setting should not be modified.)

13.2.5 Temperature

Class	Subclass	Name	Type	Min	Max	Default	Unit	Description
Calibration	Temperature	Internal Temp Offset	I1	-128	127	0	0.1°C	Internal temperature sensor reading offset
Calibration	Temperature	External 1 Temp Offset	I1	-128	127	0	0.1°C	TS1 temperature sensor reading offset

13.2.6 Internal Temp Model

Class	Subclass	Name	Type	Min	Max	Default	Unit	Description
Calibration	Internal Temp Model	Int Gain	I2	-32768	32768	-12143	—	Internal temperature gain
Calibration	Internal Temp Model	Int Base Offset	I2	-32768	32768	6232	—	Internal temperature base offset
Calibration	Internal Temp Model	Int Minimum AD	I2	-32768	32768	0	—	Minimum AD count used for calculation
Calibration	Internal Temp Model	Int Maximum Temp	I2	-32768	32768	6232	0.1 °K	Maximum Temperature boundary

13.2.7 Cell Temp Model

Class	Subclass	Name	Type	Min	Max	Default	Unit	Description
Calibration	Cell Temp Model	Coefficient a1	I2	-32768	32768	-11130	—	Cell Temperature calculation polynomial a1
Calibration	Cell Temp Model	Coefficient a2	I2	-32768	32768	19142	—	Cell Temperature calculation polynomial a2
Calibration	Cell Temp Model	Coefficient a3	I2	-32768	32768	-19262	—	Cell Temperature calculation polynomial a3
Calibration	Cell Temp Model	Coefficient a4	I2	-32768	32768	28203	—	Cell Temperature calculation polynomial a4

Class	Subclass	Name	Type	Min	Max	Default	Unit	Description
Calibration	Cell Temp Model	Coefficient a5	I2	-32768	32768	892	—	Cell Temperature calculation polynomial a5
Calibration	Cell Temp Model	Coefficient b1	I2	-32768	32768	328	—	Cell Temperature calculation polynomial b1
Calibration	Cell Temp Model	Coefficient b2	I2	-32768	32768	-605	—	Cell Temperature calculation polynomial b2
Calibration	Cell Temp Model	Coefficient b3	I2	-32768	32768	-2443	—	Cell Temperature calculation polynomial b3
Calibration	Cell Temp Model	Coefficient b4	I2	-32768	32768	4969	—	Cell Temperature calculation polynomial b4
Calibration	Cell Temp Model	Rc0	I2	-32768	32768	11703	Ω	Resistance at 25°C
Calibration	Cell Temp Model	Adc0	I2	-32768	32768	11703	—	ADC reading at 25°C
Calibration	Cell Temp Model	Rpad	I2	-32768	32768	0 ⁽¹⁾	Ω	Pad Resistance (0 to use factory calibration)
Calibration	Cell Temp Model	Rint	I2	-32768	32768	0 ⁽¹⁾	Ω	Pullup resistor resistance (0 to use factory calibration)

⁽¹⁾ Setting this value to 0 causes the gauge to use the internal factory calibration default.

13.3 Settings

13.3.1 Configuration

Class	Subclass	Name	Type	Min	Max	Default	Description
Settings	Configuration	FET Options	H1	0x00	0xFF	0x20	Bit 0: Reserved Bit 1: Reserved Bit 2: OTFET—FET action in OVERTEMPERATURE mode 0 = No FET action for overtemperature condition (default) 1 = CHG and DSG FETs will be turned off for overtemperature conditions. Bit 3: CHGSU—FET action in CHARGE SUSPEND mode 0 = FET active (default) 1 = Charging or Precharging disabled, FET off Bit 4: CHGIN—FET action in CHARGE INHIBIT mode 0 = FET active (default) 1 = Charging or Precharging disabled, FET off Bit 5: CHGFET—FET action on valid charge termination 0 = FET active (default) 1 = Charging or Precharging disabled, FET off Bit 6: SLEEPCHG—CHG FET enabled during sleep 0 = CHG FET off during sleep (default) 1 = CHG FET remains on during sleep Bit 7: Reserved
Settings	Configuration	Gauging Configuration	H1	0x00	0x0F	0x04	Bit 0: RSOC— <i>RelativeStateOfCharge()</i> and <i>RemainingCapacity()</i> behavior at end of charge 0 = Actual value shown (default) 1 = Held at 99% until valid charge termination. On entering valid charge termination update to 100% Bit 1: RSOC_HOLD—Prevent RSOC from increasing during discharge 0 = RSOC not limited 1 = RSOC not allowed to increase during discharge Bit 2: LOCK0—Keep <i>RemainingCapacity()</i> and <i>RelativeStateOfCharge()</i> from jumping back during relaxation after 0 was reached during discharge. 0 = Disabled (default) 1 = Enabled Bit 7:3: Reserved
Settings	Configuration	I2C Configuration	H1	0x00	0xFF	0x01	Bit 0: BCAST—Enable charging broadcast from device to smart charger 0 = Disabled 1 = Enabled (default) Bit 1: Reserved Bit 2: Reserved Bit 3: XL—Enable 400-kHz COM mode 0 = Normal bus speed (default) 1 = 400-kHz bus speed (slave mode) Bit 5:4: Reserved Bit 6: TO_STRETCH_EN—Enable bus timeouts (15-ms clock high and 25ms clock low) 0 = Disabled (default) 1 = Enabled Bit 7: FLASH_BUSY_WAIT—Enable clock stretching during a flash program or erase operation 0 = Disabled (default) 1 = Enabled

Class	Subclass	Name	Type	Min	Max	Default	Description
Settings	Configuration	Power Configuration	H1	0x00	0x01	0x00	Bit 0: AUTO_SHIP_EN—Automatically shut down for shipment 0 = Disable auto shutdown feature (default) 1 = Enable auto shutdown after device is in SLEEP mode without communication for a set period of time. Bit 3: 1: Reserved Bit 4: SLP_ACCUM—Enable sleep charge accumulation 1 = Enable sleep charge accumulation 0 = Disable sleep charge accumulation (default) Bit 5: SLEEPWKCHG—Enable sleep wake charge feature 1 = Enable sleep wake charge feature 0 = Disable sleep wake charge feature (default) Bit 7: 6: Reserved
Settings	Configuration	SOC Flag Config A	H2	0x0000	0xFFFF	0x0C8C	Bit 0: TDSETV—Enable TD flag set by cell voltage threshold 0 = Disabled (default) 1 = Enabled Bit 1: TDCLEARV—Enable TD flag clear by cell voltage threshold 0 = Disabled (default) 1 = Enabled Bit 2: TDSETRSOC—Enable TD flag set by RSOC threshold 0 = Disabled 1 = Enabled (default) Bit 3: TDCLEARRSOC—Enable TD flag clear by RSOC threshold 0 = Disabled 1 = Enabled (default) Bit 4: TCSETV—Enable TC flag set by cell voltage threshold 0 = Disabled (default) 1 = Enabled Bit 5: TCCLEARV—Enable TC flag clear by cell voltage threshold 0 = Disabled (default) 1 = Enabled Bit 6: TCSETRSOC—Enable TC flag set by RSOC threshold 0 = Disabled (default) 1 = Enabled Bit 7: TCCLEARRSOC—Enable TC flag clear by RSOC threshold 0 = Disabled 1 = Enabled (default) Bit 8: Reserved Bit 9: Reserved Bit 10: FCSETVCT—Enable FC flag set by primary charge termination 0 = Disabled 1 = Enabled (default) Bit 11: TCSETVCT—Enable TC flag set by primary charge termination 0 = Disabled 1 = Enabled (default) Bit 15: 12: Reserved
Settings	Configuration	SOC Flag Config B	H1	0x0000	0x00FF	0x008C	Bit 0: FDSETV—Enable FD flag set by cell voltage threshold 0 = Disabled (default) 1 = Enabled Bit 1: FDCLEARV—Enable FD flag clear by cell voltage threshold 0 = Disabled (default) 1 = Enabled Bit 2: FDSETRSOC—Enable FD flag set by RSOC threshold 0 = Disabled 1 = Enabled (default) Bit 3: FDCLEARRSOC—Enable FD flag clear by RSOC threshold 0 = Disabled 1 = Enabled (default) Bit 4: FCSETV—Enable FC flag set by cell voltage threshold 0 = Disabled (default) 1 = Enabled Bit 5: FCCLEARV—Enable FC flag clear by cell voltage threshold 0 = Disabled (default) 1 = Enabled Bit 6: FCSETRSOC—Enable FC flag set by RSOC threshold 0 = Disabled (default) 1 = Enabled Bit 7: FCCLEARRSOC—Enable FC flag clear by RSOC threshold 0 = Disabled 1 = Enabled (default)
Settings	Configuration	Charging Configuration	H1	0x00	0x3F	0x00	Bit 0: CRATE—ChargeCurrent rate 0 = No adjustment to <i>ChargingCurrent()</i> (default) 1 = <i>ChargingCurrent()</i> adjusted based on <i>FullChargeCapacity()/DesignCapacity()</i> Bit 7: 1: Reserved
Settings	Configuration	Temperature Enable	H1	0x00	0x03	0x03	Bit 0: internal TS— Enable Internal TS 0 = Disable internal TS (default) 1 = Enable internal TS Bit 1: TS1—Enable TS1 0 = Disable TS1 1 = Enable TS1 (default) Bit 7: 2: Reserved

Class	Subclass	Name	Type	Min	Max	Default	Description
Settings	Configuration	DA Configuration	H1	0x00	0xFF	0x11	Bit 0: CC0—Cell Count 0 = 1 cell 1 = 2 cell Bit 1: Reserved Bit 2: Reserved Bit 3: IN_SYSTEM_SLEEP—In-system SLEEP mode 0 = Disable (default) 1 = Enable Bit 4: SLEEP—SLEEP Mode 0 = Disable SLEEP mode 1 = Enable SLEEP mode (default) Bit 5: Reserved Bit 6: CTEMP—Cell Temperature protection source 0 = MAX (default) 1 = Average Bit 7: Reserved
Settings	Configuration	IT Gauging Configuration	H2	0x0000	0xFFFF	0xD4DE	Bit 0: CCT—Cycle count threshold 0 = Use CC % of <i>DesignCapacity()</i> (default) 1 = Use CC % of <i>FullChargeCapacity()</i> Bit 1: CSYNC—Sync <i>RemainingCapacity()</i> with <i>FullChargeCapacity()</i> at valid charge termination 0 = Not synchronized 1 = Synchronized (default) Bit 2: RFACTSTEP—Allow Ra update to limit before disqualifying further updates 0 = If (new Ra)/(old Ra) > 3, Ra update is not completed, and Ra updates are disabled. 1 = If (new Ra)/(old Ra) > 3, one Ra update is completed limited to factor of 3, and further Ra updates are disabled. Bit 3: OCVR—Open Circuit Voltage Flat Region 0 = Disabled 1 = Enabled (default) Bit 4: Reserved Bit 5: Reserved Bit 6: RSOC_CONV—See Section 6.6 . Bit 7: FAST_QMax_LRN—See Section 6.6 . Bit 8: FAST_Qmax_FLD—See Section 6.6 . Bit 9: CELL_TERM—See Section 6.6 . Bit 10: FF_NEAR_EDV—See Section 6.6 . Bit 11: RELAX_JUMP_OK—See Section 6.6 . Bit 12: SMOOTH—See Section 6.6 . Bit 13: Reserved Bit 14: Reserved Bit 15: Reserved
Settings	Configuration	Balancing Configuration	H1	0x00	0xFF	0x01	Bit 0: CB—Cell balancing 0 = Cell balancing disabled 1 = Cell balancing enabled (default) Bit 1: Reserved Bit 2: CBR—Cell balancing at rest 0 = Cell balancing at rest is disabled (default). 1 = Cell balancing at rest is enabled. Bit 7:3: Reserved

13.3.2 Charger

NOTE: The BROADCAST mode feature is available in the latest firmware version in the BQ28Z610 product folder on TI.com. It is not included in the shipped version.

The following data flash parameters enable the configuration of the BROADCAST mode feature. This feature is disabled by default because not all host MCU/CPU's are compatible with multi-master I²C operation, and collisions could hang the host's comm engine.

Class	Subclass	Name	Type	Min	Max	Default	Unit	Description
Settings	Charger	Device Address	H1	0	FF	D4	hex	Sets the address of slave device for BROADCAST mode
Settings	Charger	Voltage Register	H1	0	FF	0C	hex	BROADCAST mode: Sets the 2-byte address and data information to transmit to the slave device for charger output voltage setting
Settings	Charger	Current Register	H1	0	FF	0A	hex	BROADCAST mode: Sets the 2-byte address and data information to transmit to the slave device for charger output current setting
Settings	Charger	Broadcast Pacing	U1	0	255	15	s	BROADCAST mode: Period for broadcast

13.3.3 Protection

Class	Subclass	Name	Type	Min	Max	Default	Description
Settings	Protection	Protection Configuration	H1	0x00	0xFF	0x00	Bit 0: Reserved Bit 1: CUV_RECOV_CHG—Require charge to recover SafetyStatus()[CUV] 0 = Disabled 1 = Enabled (default) Bit 7:2: Reserved
Settings	Protection	Enabled Protections A	H1	0x00	0xFF	0x57	Bit 0: CUV—Cell Undervoltage 0 = Disabled 1 = Enabled (default) Bit 1: COV—Cell Overvoltage 0 = Disabled 1 = Enabled (default) Bit 2: OCC—Overcurrent in Charge 0 = Disabled 1 = Enabled (default) Bit 3: Reserved Bit 4: OCD—Overcurrent in Discharge 0 = Disabled 1 = Enabled (default) Bit 5: Reserved Bit 6: Reserved (will be 1) Bit 7: Reserved
Settings	Protection	Enabled Protections B	H1	0x00	0xFF	0x35	Bit 0: Reserved (will be 1) Bit 1: Reserved Bit 2: Reserved (will be 1) Bit 3: Reserved Bit 4: OTC—Overtemperature in charge 0 = Disabled 1 = Enabled (default) Bit 5: OTD—Overtemperature in discharge 0 = Disabled 1 = Enabled (default) Bit 7:6: Reserved
Settings	Protection	Enabled Protections C	H1	0x00	0xFF	0x3C	Bit 0: Reserved Bit 1: Reserved Bit 2: PTO—Precharging timeout 0 = Disabled 1 = Enabled (default) Bit 3: Reserved Bit 4: CTO—Charging timeout 0 = Disabled 1 = Enabled (default) Bit 7:5: Reserved
Settings	Protection	Enabled Protections D	H1	0x00	0xFF	0x0C	Bit 0: Reserved Bit 1: Reserved Bit 2: UTC—Undertemperature while charging 0 = Disabled 1 = Enabled (default) Bit 3: UTD—Undertemperature while not charging 0 = Disabled 1 = Enabled (default) Bit 7:4: Reserved

13.3.4 Permanent Failure

Class	Subclass	Name	Type	Min	Max	Default	Description
Settings	Permanent Failure	Enabled PF A	H1	0x00	0xFF	0x00	Bit 0: Reserved Bit 1: SOV—Safety Cell Overvoltage 0 = Disabled (default) 1 = Enabled Bit 7: 2: Reserved
Settings	Permanent Failure	Enabled PF B	H1	0x00	0xFF	0x00	Bit 2: 0: Reserved Bit 3: VIMR—Voltage Imbalance At Rest 0 = Disabled (default) 1 = Enabled Bit 4: VIMA—Voltage Imbalance At Active 0 = Disabled (default) 1 = Enabled Bit 7: 5: Reserved
Settings	Permanent Failure	Enabled PF C	H1	0x00	0xFF	0x00	Bit 0: CFETF—Charge FET Failure 0 = Disabled (default) 1 = Enabled Bit 1: DFETF—Discharge FET Failure 0 = Disabled (default) 1 = Enabled Bit 7: 2: Reserved

13.3.5 AFE

Class	Subclass	Name	Type	Min	Max	Default	Description
Configuration	AFE	AFE Protection Control	H1	0x00	0xFF	0x00	Bit 0: RSNS—AOLD, ASCC, ASCD1, ASCD2 Thresholds 0 = 0.5 × AFE Protection Thresholds (default) 1 = Normal AFE Protection Thresholds Bit 1: SCDDx2—Double SCD Delay Times 0 = Normal SCD delay times (default) 1 = 2 × SCD delay times Bits 2–3: Reserved Bit 4–7: RSTRIM—“Unsupport” function. Should leave the default setting 0x7. Changing this setting may cause an error to the AFE current protection accuracy.
Configuration	AFE	ZVCHG Exit Threshold	I2	0	8000	2200	Voltage() threshold in mV when the gauge will exit ZVCHG mode when CFET is used for precharging.

13.3.6 Manufacturing

Class	Subclass	Name	Type	Min	Max	Default	Description
Settings	Manufacturing	Manufacturing Status	H2	0x0000	0xFFFF	0x0000	Bit 0: Reserved Bit 1: Reserved Bit 2: Reserved Bit 3: GAUGE_EN—Gauging 0 = Disabled (default) 1 = Enabled Bit 4: FET_EN—FET action 0 = Disabled (default) 1 = Enabled Bit 5: LF_EN—Lifetime data collection 0 = Disabled (default) 1 = Enabled Bit 6: PF_EN—Permanent failure 0 = Disabled (default) 1 = Enabled Bit 15:7: Reserved

13.4 Advanced Charging Algorithms

13.4.1 Temperature Ranges

Class	Subclass	Name	Type	Min	Max	Default	Unit	Description
Advanced Charging Algorithms	Temperature Ranges	T1	I1	–128	127	0	°C	T1 low temperature range lower limit
Advanced Charging Algorithms	Temperature Ranges	T2	I1	–128	127	12	°C	T2 low temperature range to standard temperature range
Advanced Charging Algorithms	Temperature Ranges	T5	I1	–128	127	20	°C	T5 recommended temperature range lower limit
Advanced Charging Algorithms	Temperature Ranges	T6	I1	–128	127	25	°C	T6 recommended temperature range upper limit
Advanced Charging Algorithms	Temperature Ranges	T3	I1	–128	127	30	°C	T3 standard temperature range to high temperature range
Advanced Charging Algorithms	Temperature Ranges	T4	I1	–128	127	55	°C	T4 high temperature range upper limit
Advanced Charging Algorithms	Temperature Ranges	Hysteresis	I1	–128	127	1	°C	Temperature Hysteresis, applied when temperature is decreasing.

13.4.2 Low Temp Charging

Class	Subclass	Name	Type	Min	Max	Default	Unit	Description
Advanced Charging Algorithms	Low Temp Charging	Voltage	I2	0	32767	4000	mV	Low temperature range <i>ChargingVoltage()</i>
Advanced Charging Algorithms	Low Temp Charging	Current Low	I2	0	32767	132	mA	Low temperature range low voltage range <i>ChargingCurrent()</i>
Advanced Charging Algorithms	Low Temp Charging	Current Med	I2	0	32767	352	mA	Low temperature range medium voltage range <i>ChargingCurrent()</i>
Advanced Charging Algorithms	Low Temp Charging	Current High	I2	0	32767	264	mA	Low temperature range high voltage range <i>ChargingCurrent()</i>

13.4.3 Standard Temp Charging

Class	Subclass	Name	Type	Min	Max	Default	Unit	Description
Advanced Charging Algorithms	Standard Temp Charging	Voltage	I2	0	32767	4200	mV	Standard temperature range <i>ChargingVoltage()</i>
Advanced Charging Algorithms	Standard Temp Charging	Current Low	I2	0	32767	1980	mA	Standard temperature range low voltage range <i>ChargingCurrent()</i>
Advanced Charging Algorithms	Standard Temp Charging	Current Med	I2	0	32767	4004	mA	Standard temperature range medium voltage range <i>ChargingCurrent()</i>
Advanced Charging Algorithms	Standard Temp Charging	Current High	I2	0	32767	2992	mA	Standard temperature range high voltage range <i>ChargingCurrent()</i>

13.4.4 High Temp Charging

Class	Subclass	Name	Type	Min	Max	Default	Unit	Description
Advanced Charging Algorithms	High Temp Charging	Voltage	I2	0	32767	4000	mV	High temperature range <i>ChargingVoltage()</i>
Advanced Charging Algorithms	High Temp Charging	Current Low	I2	0	32767	1012	mA	High temperature range low voltage range <i>ChargingCurrent()</i>
Advanced Charging Algorithms	High Temp Charging	Current Med	I2	0	32767	1980	mA	High temperature range medium voltage range <i>ChargingCurrent()</i>
Advanced Charging Algorithms	High Temp Charging	Current High	I2	0	32767	1496	mA	High temperature range high voltage range <i>ChargingCurrent()</i>

13.4.5 Rec Temp Charging

Class	Subclass	Name	Type	Min	Max	Default	Unit	Description
Advanced Charging Algorithms	Rec Temp Charging	Voltage	I2	0	32767	4100	mV	Recommended temperature range <i>ChargingVoltage()</i>
Advanced Charging Algorithms	Rec Temp Charging	Current Low	I2	0	32767	2508	mA	Recommended temperature range low voltage range <i>ChargingCurrent()</i>
Advanced Charging Algorithms	Rec Temp Charging	Current Med	I2	0	32767	4488	mA	Recommended temperature range medium voltage range <i>ChargingCurrent()</i>

Class	Subclass	Name	Type	Min	Max	Default	Unit	Description
Advanced Charging Algorithms	Rec Temp Charging	Current High	I2	0	32767	3520	mA	Recommended temperature range high voltage range <i>ChargingCurrent()</i>

13.4.6 Pre-Charging

Class	Subclass	Name	Type	Min	Max	Default	Unit	Description
Advanced Charging Algorithms	PCHG	Current	I2	0	32767	88	mA	Precharge <i>ChargingCurrent()</i>

13.4.7 Maintenance Charging

Class	Subclass	Name	Type	Min	Max	Default	Unit	Description
Advanced Charging Algorithms	MCHG	Current	I2	0	32767	44	mA	Maintenance <i>ChargingCurrent()</i>

13.4.8 Voltage Range

Class	Subclass	Name	Type	Min	Max	Default	Unit	Description
Advanced Charging Algorithms	Voltage Range	Threshold for entering precharge state	I2	0	32767	2500	mV	Minimum Cell voltage to enter PRECHARGE mode
Advanced Charging Algorithms	Voltage Range	Charging Voltage Low	I2	0	32767	2900	mV	Precharge Voltage range to Charging Voltage Low range
Advanced Charging Algorithms	Voltage Range	Charging Voltage Med	I2	0	32767	3600	mV	Charging Voltage Low range to Charging Voltage Med range
Advanced Charging Algorithms	Voltage Range	Charging Voltage High	I2	0	32767	4000	mV	Charging Voltage Med to Charging Voltage High range
Advanced Charging Algorithms	Voltage Range	Charging Voltage Hysteresis	U1	0	255	0	mV	Charging Voltage Hysteresis applied when voltage is decreasing

13.4.9 Termination Config

Class	Subclass	Name	Type	Min	Max	Default	Unit	Description
Advanced Charging Algorithms	Termination Config	Charge Term Taper Current	I2	0	32767	250	mA	Valid Charge Termination taper current qualifier threshold
Advanced Charging Algorithms	Termination Config	Charge Term Voltage	I2	0	32767	75	mV	Valid Charge Termination delta voltage qualifier, max cell based

13.4.10 Cell Balancing Config

Class	Subclass	Name	Type	Min	Max	Default	Unit	Description
Advanced Charging Algorithms	Cell Balancing Config	Balance Time per mAh cell 1	U2	0	65535	367	s/mAh	Required balance time per mAh. For information on how to calculate balancing time, see Section 7.1 .
Advanced Charging Algorithms	Cell Balancing Config	Balance Time per mAh cell 2	U2	0	65535	514	s/mAh	Required balance time per mAh. For information on how to calculate balancing time, see Section 7.1 .

13.5 Power

13.5.1 Power

Class	Subclass	Name	Type	Min	Max	Default	Unit	Description
Power	Power	Valid Update Voltage	I2	0	32767	2800	mV	Min stack voltage threshold for Flash update

13.5.2 Shutdown

Class	Subclass	Name	Type	Min	Max	Default	Unit	Description
Power	Shutdown	Shutdown Voltage	I2	0	32767	2300	mV	Cell based shutdown voltage trip threshold
Power	Shutdown	Shutdown Time	U2	0	255	10	s	Cell based shutdown voltage trip delay
Power	Shutdown	Charger Present Threshold	I2	0	32767	3000	mV	Pack terminal charger present detect threshold

13.5.3 Sleep

Class	Subclass	Name	Type	Min	Max	Default	Unit	Description
Power	Sleep	Sleep Current	I2	0	32767	10	mA	Current() threshold to enter SLEEP mode
Power	Sleep	Voltage Time	U1	0	255	5	s	Voltage sampling period in SLEEP mode
Power	Sleep	Current Time	U1	0	255	20	s	Current sampling period in SLEEP mode
Power	Sleep	Wake Comparator	H1	0x00	0xFF	0x00	—	Wake Comparator Configuration Setting Bits 7–4: Reserved Bits 3–2: Wk1, WK0—Wake Comparator Threshold 0,0 = ±0.625 mV 0,1 = ±1.25 mV 1,0 = ±2.5 mV 1,1 = ±5 mV Bits 1–0: Reserved

13.5.4 Ship

Class	Subclass	Name	Type	Min	Max	Default	Unit	Description
Power	Ship	FET OFF time	U1	0	127	10	s	Delay time to turn OFF FETs prior to entering SHUTDOWN mode. This setting should not be longer than the Ship Delay setting.
Power	Ship	Delay	U1	0	254	20	s	Delay time to enter SHUTDOWN mode after FETs are turned OFF
Power	Ship	Auto Ship Time	U2	0	65535	1440	min	The device will automatically enter SHUTDOWN mode after staying in SLEEP mode without communicating for this amount of time when Power Config[AUTO_SHIP_EN] = 1.

13.6 Gas Gauging

13.6.1 Standby

Class	Subclass	Name	Type	Min	Max	Default	Unit	Description
Gas Gauging	Standby	Standby Current	I2	-32768	0	-10	mA	

13.6.2 Max Load

Class	Subclass	Name	Type	Min	Max	Default	Unit	Description
Gas Gauging	Max Load	Max Load Current	I2	-32768	32767	-500	mA	
Gas Gauging	Max Load	Max Load RSOC	U1	0	100	50	%	

13.6.3 Current Thresholds

Class	Subclass	Name	Type	Min	Max	Default	Unit	Description
Gas Gauging	Current Thresholds	Dsg Current Threshold	I2	-32768	32767	100	mA	DISCHARGE mode <i>Current()</i> threshold
Gas Gauging	Current Thresholds	Chg Current Threshold	I2	-32768	32767	50	mA	CHARGE mode <i>Current()</i> threshold
Gas Gauging	Current Thresholds	Quit Current	I2	0	32767	10	mA	<i>Current()</i> threshold to enter REST mode
Gas Gauging	Current Thresholds	Dsg Relax Time	U1	0	255	1	mA	Discharge to relax timeout
Gas Gauging	Current Thresholds	Chg Relax Time	U1	0	255	60	mA	Charge to relax timeout

13.6.4 Design

Class	Subclass	Name	Type	Min	Max	Default	Unit	Description
Gas Gauging	Design	Design Capacity mAh	I2	0	32767	4400	mAh	Design Capacity in mAh
Gas Gauging	Design	Design Capacity cWh	I2	0	32767	6336	cWh	Design Capacity in cWh
Gas Gauging	Design	Design Voltage	I2	0	32767	7200	mV	Design Voltage

13.6.5 Cycle

Class	Subclass	Name	Type	Min	Max	Default	Unit	Description
Gas Gauging	Cycle	Cycle Count Percentage	U1	0	100	90	%	Cycle Count Percentage

13.6.6 FD

Class	Subclass	Name	Type	Min	Max	Default	Unit	Description
Gas Gauging	FD	Set Voltage Threshold	I2	0	5000	3000	mV	<i>BatteryStatus()</i> [FD] cell voltage set threshold
Gas Gauging	FD	Clear Voltage Threshold	I2	0	5000	3100	mV	<i>BatteryStatus()</i> [FD] cell voltage clear threshold
Gas Gauging	FD	Set RSOC % Threshold	U1	0	100	0	%	<i>BatteryStatus()</i> [FD] <i>RelativeStateOfCharge()</i> set threshold
Gas Gauging	FD	Clear RSOC % Threshold	U1	0	100	5	%	<i>BatteryStatus()</i> [FD] <i>RelativeStateOfCharge()</i> clear threshold

13.6.7 FC

Class	Subclass	Name	Type	Min	Max	Default	Unit	Description
Gas Gauging	FC	Set Voltage Threshold	I2	0	5000	4200	mV	<i>BatteryStatus()</i> [FC] cell voltage set threshold
Gas Gauging	FC	Clear Voltage Threshold	I2	0	5000	4100	mV	<i>BatteryStatus()</i> [FC] cell voltage clear threshold
Gas Gauging	FC	Set RSOC % Threshold	U1	0	100	100	%	<i>BatteryStatus()</i> [FC] <i>RelativeStateOfCharge()</i> set threshold
Gas Gauging	FC	Clear RSOC % Threshold	U1	0	100	95	%	<i>BatteryStatus()</i> [FC] <i>RelativeStateOfCharge()</i> clear threshold

13.6.8 TDA

Per the *Smart Battery Data Specification v1.1*, TDA is only active while discharging.

Class	Subclass	Name	Type	Min	Max	Default	Unit	Description
Gas Gauging	TD	Set Voltage Threshold	I2	0	5000	3200	mV	<i>GaugingStatus</i> [TD] cell voltage set threshold
Gas Gauging	TD	Clear Voltage Threshold	I2	0	5000	3300	mV	<i>GaugingStatus</i> [TD] cell voltage clear threshold
Gas Gauging	TD	Set RSOC % Threshold	U1	0	100	6	%	<i>GaugingStatus</i> [TD] <i>RelativeStateOfCharge()</i> set threshold
Gas Gauging	TD	Clear RSOC % Threshold	U1	0	100	8	%	<i>GaugingStatus</i> [TD] <i>RelativeStateOfCharge()</i> clear threshold

13.6.9 TCA

Per the *Smart Battery Data Specification v1.1*, TCA is only active while charging.

Class	Subclass	Name	Type	Min	Max	Default	Unit	Description
Gas Gauging	TC	Set Voltage Threshold	I2	0	5000	4200	mV	<i>GaugingStatus</i> [TC] cell voltage set threshold
Gas Gauging	TC	Clear Voltage Threshold	I2	0	5000	4100	mV	<i>GaugingStatus</i> [TC] cell voltage clear threshold
Gas Gauging	TC	Set RSOC % Threshold	U1	0	100	100	%	<i>GaugingStatus</i> [TC] <i>RelativeStateOfCharge()</i> set threshold
Gas Gauging	TC	Clear RSOC % Threshold	U1	0	100	95	%	<i>GaugingStatus</i> [TC] <i>RelativeStateOfCharge()</i> clear threshold

13.6.10 State

Class	Subclass	Name	Type	Min	Max	Default	Unit	Description
Gas Gauging	State	QMax Cell 0	I2	0	32767	4400	mAh	QMax Cell 0
Gas Gauging	State	QMax Cell 1	I2	0	32767	4400	mAh	QMax Cell 1
Gas Gauging	State	QMax Pack	I2	0	32767	4400	mAh	QMax of the whole stack
Gas Gauging	State	QMax Cycle count	U2	0	65535	0		The <i>CycleCount()</i> when QMax updated
Gas Gauging	State	Update Status	H1	0x00	0xFF	0		Bit 1:0: Update1, Update0 Update Status 0,0 = Impedance Track gauging and lifetime updating is disabled. 0,1 = QMax updated 1,0 = QMax and Ra table have been updated Bit 2: Enable—Impedance Track gauging and lifetime updating is enabled. 0 = Disabled 1 = Enabled Bit 3: QMax update in the field 0 = Not updated 1 = Updated Bit 7:4: Reserved
Gas Gauging	State	Cell 0 Chg Voltage at EoC	I2	0	32767	4200	mV	Cell 0 voltage value at end of charge
Gas Gauging	State	Cell 1 Chg Voltage at EoC	I2	0	32767	4200	mV	Cell 1 voltage value at end of charge
Gas Gauging	State	Current at EoC	I2	-32768	32767	250	mA	Current at end of charge
Gas Gauging	State	Avg I Last Run	I2	-32768	32767	-2000	mA	Average current last discharge cycle
Gas Gauging	State	Avg P Last Run	I2	-32768	32767	-3022	10 mW	Average power last discharge cycle
Gas Gauging	State	Delta Voltage	I2	-32768	32767	0	mV	<i>Voltage()</i> delta between normal and short load spikes to optimize run time calculation
Gas Gauging	State	Temp k	I2	0	32767	100	0.1°C/ 256 cW	Initial thermal model temperature factor
Gas Gauging	State	Temp a	I2	0	32767	1000	—	Initial thermal model temperature
Gas Gauging	State	Max I Last Run	I2	-32768	32767	-2000	mA	Max current last discharge cycle
Gas Gauging	State	Max P Last Run	I2	-32768	32767	-3022	10 mW	Max power last discharge cycle
Gas Gauging	State	Cycle count	U2	0	65535	0	Cycle count	Value reported by <i>CycleCount()</i> . Updated by the gauge automatically when accumulated discharge exceeds the threshold set by Cycle Count Percentage
Gas Gauging	State	SOH Temp k	I2	0	32767	100	0.1°C/ 256 cW	Initial thermal model temperature factor for SOH
Gas Gauging	State	SOH Temp a	I2	0	32767	1000	—	Initial thermal model temperature factor for SOH

13.6.11 IT Config

Class	Subclass	Name	Type	Min	Max	Default	Unit	Description
Gas Gauging	IT Cfg	Pack Resistance	I2	0	32767	30	mΩ	
Gas Gauging	IT Cfg	System Resistance	I2	0	32767	0	mΩ	

Class	Subclass	Name	Type	Min	Max	Default	Unit	Description
Gas Gauging	IT Cfg	Ra Filter	U2	0	999	500	0.1%	Filter value used in Ra Updates, specifies what percentage of Ra update is from new value (100%—setting) vs. old value (setting). The recommended setting is 80% if the RSOC_CONV feature is enabled. Otherwise, the setting should be 50% as the default.
Gas Gauging	IT Cfg	Ra Max Delta	U1	0	255	15	% of Design Resistance	Maximum value of allowed Ra change
Gas Gauging	IT Cfg	Reference Grid	UI	0	15	4		Reference Grid point used by Design Resistance. The default setting should be used if RSOC_CONV feature is enabled. Otherwise, grid point 11 should be used to ensure resistance updates fast enough at the grid where discharge termination occurs.
Gas Gauging	IT Cfg	Resistance Parameter Filter	U2	1	65534	65124	—	This is one of the filters used for resistance update. Reducing this filter setting can improve low temperature performance at high rates. The default setting is 41-s time constant. It is recommended to keep this filter within the range of 4 s (that is, DF setting = 61680) up to the default 41 s (that is, DF setting = 65142). Examining the Term Voltage Delta setting and Fast Scale Start SOC should be done prior to twisting this parameter when trying to improve the RSOC performance. The following is the formula to convert the DF setting into actual filter time constant: Filter time constant = $[0.25/(1 - (DF_Value / 65536))] - 0.25$.
Gas Gauging	IT Cfg	Near EDV Ra Param Filter	U2	1	65535	59220	—	Ra filter used in the fast scaling region if [FF_NEAR_EDV] = 1. Default value should be used.
Gas Gauging	IT Cfg	QMax Delta	U1	3	100	5	%	Maximum allowed QMax change from its previous value. The QMax change will be capped by this setting if the delta from the previous QMax is larger than QMax Delta . QMax Delta is a percentage of Design Capacity.
Gas Gauging	IT Cfg	QMax Upper Bound	U1	100	255	130	%	Maximum QMax value over the lifetime of the pack. If the updated QMax value is larger than this setting, the updated QMax will be capped to QMax Upper Bound . QMax Upper Bound is a percentage of Design Capacity.
Gas Gauging	IT Cfg	Term Voltage	I2	0	32767	9000	mV	Min stack voltage to be used for capacity calculation
Gas Gauging	IT Cfg	Term Voltage Delta	I2	0	32767	300	mV	Controls when the RSOC_CONV feature becomes active. The recommended setting is 3.3 –Term Voltage/Number Cells. The default setting is 300 mV, which is assuming a typical 3-V termination voltage per cell. If a different termination voltage is used, this parameter should be adjusted accordingly.
Gas Gauging	IT Cfg	Term Min Cell Voltage	I2	0	32767	2800	mV	Minimum cell termination voltage when used, if [CELL_TERM]= 1. This is intended to allow the IT algorithm to reach 0% before CUV is triggered; therefore, this value should be set at or above CUV.Threshold .
Gas Gauging	IT Cfg	Fast Scale Start SOC	U1	0	100	10	%	Control start of convergence when [RSOC_CONV]= 1 based on RSOC %. Raising this setting can improve RSOC drop at the end of discharge. However the RSOC % chosen for this setting must keep after the sharp drop of the discharge curve (the knee of the discharge curve).
Gas Gauging	IT Cfg	Load Select	U1	0	255	7		Defines Load compensation mode used by the gauging algorithm
Gas Gauging	IT Cfg	Load Mode	U1	0	255	0		Defines unit used by the gauging algorithm: 0 = Constant Current 1 = Constant Power

Class	Subclass	Name	Type	Min	Max	Default	Unit	Description
Gas Gauging	IT Cfg	Design Resistance						Averaged cell resistance at Reference Grid point. Automatically updated when Update Status is set to 0x6 by the gauge. To automatically update again, set Update Status to 0x4 or manually set when Update Status is set to 0x6.
Gas Gauging	IT Cfg	User-Rate-mA	I2	-32768	32768	0	mA	Discharge rate used for capacity calculation selected by Load Select
Gas Gauging	IT Cfg	User-Rate-mW	I2	-32768	32768	0	10 mW	Discharge rate used for capacity calculation selected by Load Select
Gas Gauging	IT Cfg	Reserve Cap-mAh	I2	0	9000	0	mAh	Capacity is reserved available when the gauging algorithm reports 0% <i>RelativeStateOfCharge()</i> .
Gas Gauging	IT Cfg	Reserve Cap-cWh	I2	0	32000	0	cWh	Capacity reserved is available when the gauging algorithm reports 0% <i>RelativeStateOfCharge()</i> .

13.6.12 Condition Flag

Class	Subclass	Name	Type	Min	Max	Default	Unit	Description
Gas Gauging	Condition Flag	Max Error Limit	U1	1	100	100	%	Max Error Limit Percentage

13.6.13 SOH

Class	Subclass	Name	Type	Min	Max	Default	Unit	Description
Gas Gauging	SOH	SOH Load Rate	U1	1	255	50	0.1 Hr rate	Current rate used in SOH simulation

13.6.14 Max Error

Class	Subclass	Name	Type	Min	Max	Default	Unit	Description
Gas Gauging	Max Error	Time Cycle Equivalent	U1	1	255	12	2h	After valid QMax update, each passed time period of Time Cycle Equivalent will increment of <i>MaxError()</i> by Cycle Delta. Time Cycle Equivalent increments Max Error by 0.05% for every Time Cycle Equivalent time period following the last QMax update.
Gas Gauging	Max Error	Cycle Delta	U1	0	255	5	0.01%	Each increment of <i>CycleCount()</i> after valid QMax update will increment of <i>MaxError()</i> by Cycle Delta. Setting this parameter to 0 disables the MaxError increment by time or cycle increment.

13.7 System Data

13.7.1 Manufacturer Data

Class	Subclass	Name	Type	Min	Max	Unit	Description
System Data	Manufacturer Data	Manufacturer Info A Length	U1	0	32	—	<i>ManufacturerInfo()</i> length
System Data	Manufacturer Data	Manufacturer Info Block A01-A32	U1				<i>ManufacturerInfo()</i> value

13.7.2 Integrity

Class	Subclass	Name	Type	Min	Max	Default	Unit	Description
System Data	Integrity	Static DF Signature	H2	0	7FFF	0	hex	Status data flash signature. Use MAC <i>StaticDFSSignature()</i> (with MSB set to 0) to initialize this value.
System Data	Integrity	Static Chem DF Signature	H2	0	7FFF	6C98	hex	Status Chemistry data signature. Use MAC <i>StaticChemDFSSignature()</i> (with MSB set to 0) to initialize this value.
System Data	Integrity	All DF Signature	H2	0	7FFF	0	hex	Status data flash signature. Use MAC <i>AllDFSSignature()</i> (with MSB set to 0) to initialize this value.

13.8 Configuration

13.8.1 Data

Class	Subclass	Name	Type	Min	Max	Default	Unit	Description
Configuration	Data	Manufacturer Date	U2	0	65535	01/01/80		<i>ManufacturerDate()</i> value in the following format: Day + Month*32 + (Year-1980) * 512
Configuration	Data	Serial Number	H2	0x0000	0xFFFF	0x0001		<i>SerialNumber()</i> value
Configuration	Data	Manufacturer Name	S20+1	—	—	Texas Instruments	ASCII	<i>ManufacturerName()</i> value
Configuration	Data	Device Name	S20+1	—	—	BQ28Z610	ASCII	<i>DeviceName()</i> value
Configuration	Data	Device Chemistry	S4+1	—	—	LION	ASCII	<i>DeviceChemistry()</i> value

13.9 Lifetimes

13.9.1 Voltage

Class	Subclass	Name	Type	Min	Max	Default	Unit	Description
Lifetimes	Voltage	Max Voltage Cell 0	I2	0	32767	0	mV	Maximum reported cell voltage 0
Lifetimes	Voltage	Max Voltage Cell 1	I2	0	32767	0	mV	Maximum reported cell voltage 1

13.9.2 Current

Class	Subclass	Name	Type	Min	Max	Default	Unit	Description
Lifetimes	Current	Max Chg Current	I2	0	32768	0	200 mA	Maximum reported <i>Current()</i> in charge direction
Lifetimes	Current	Max Dsg Current	I2	-32768	0	0	200 mA	Maximum reported <i>Current()</i> in discharge direction

13.9.3 Temperature

Class	Subclass	Name	Type	Min	Max	Default	Unit	Description
Lifetimes	Temperature	Max Temp Cell	I1	-128	127	-128	°C	Maximum reported cell temperature
Lifetimes	Temperature	Min Temp Cell	I1	-128	127	127	°C	Minimum reported cell temperature

13.10 Protections

13.10.1 CUV—Cell Undervoltage

Class	Subclass	Name	Type	Min	Max	Default	Unit	Description
Protections	CUV	Threshold	I2	0	32767	2500	mV	Cell undervoltage trip threshold
Protections	CUV	Delay	U1	0	255	2	s	Cell undervoltage trip delay
Protections	CUV	Recovery	I2	0	32767	3000	mV	Cell undervoltage recovery threshold

13.10.2 COV—Cell Overvoltage

Class	Subclass	Name	Type	Min	Max	Default	Unit	Description
Protections	COV	Threshold Low Temp	I2	0	32767	4300	mV	Cell overvoltage low temperature range trip threshold
Protections	COV	Threshold Standard Temp	I2	0	32767	4300	mV	Cell overvoltage standard temperature range trip threshold
Protections	COV	Threshold High Temp	I2	0	32767	4300	mV	Cell overvoltage high temperature range trip threshold
Protections	COV	Threshold Rec Temp	I2	0	32767	4300	mV	Cell overvoltage recommended temperature range trip threshold
Protections	COV	Delay	U1	0	255	0	s	Cell overvoltage trip delay
Protections	COV	Recovery Low Temp	I2	0	32767	3900	mV	Cell overvoltage low temperature range recovery threshold
Protections	COV	Recovery Standard Temp	I2	0	32767	3900	mV	Cell overvoltage standard temperature recovery range threshold
Protections	COV	Recovery High Temp	I2	0	32767	3900	mV	Cell overvoltage high temperature range recovery threshold
Protections	COV	Recovery Rec Temp	I2	0	32767	3900	mV	Cell overvoltage recommended temperature range recovery threshold

13.10.3 OCC—Overcurrent In Charge

Class	Subclass	Name	Type	Min	Max	Default	Unit	Description
Protections	OCC	Threshold	I2	-32768	32767	6000	mA	Overcurrent in Charge trip threshold
Protections	OCC	Delay	U1	0	255	0	s	Overcurrent in Charge trip delay
Protections	OCC	Recovery Threshold	I2	-32768	32767	200	mA	Overcurrent in Charge recovery threshold
Protections	OCC	Recovery Delay	U1	0	255	5	s	Overcurrent in Charge recovery delay

13.10.4 OCD—Overcurrent In Discharge

Class	Subclass	Name	Type	Min	Max	Default	Unit	Description
Protections	OCD	Threshold	I2	-32768	32767	-6000	mA	Overcurrent in Discharge trip threshold
Protections	OCD	Delay	U1	0	255	6	s	Overcurrent in Discharge trip delay
Protections	OCD	Recovery	I2	-32768	32767	50	mA	Overcurrent in Discharge recovery threshold
Protections	OCD	Recovery Delay	U1	0	255	5	s	Overcurrent in Discharge recovery delay

13.10.5 AOLD—AFE Over Load In Discharge

Class	Subclass	Name	Type	Min	Max	Default	Unit	Description
Protections	AOLD	Threshold	H1	0x00	0xFF	0xF4	hex	AOLD: Threshold Setting, Bits 7–4: OLDD: AOLD delay time Setting, Bits 3–0: OLDV: AOLD threshold
Protections	AOLD	Recovery	U1	0	255	5	s	Overload recovery time

13.10.6 ASCC—AFE Short Circuit in Charge

Class	Subclass	Name	Type	Min	Max	Default	Unit	Description
Protections	ASCC	Threshold	H1	0x00	0xFF	0x77	hex	ASCC: Threshold Setting, Bits 7–4: SCCD: ASCC delay time Setting, Bit 3: Reserved Setting, Bits 2–0: OLDV: AOLD threshold Setting
Protections	ASCC	Recovery	U1	0	255	5	s	Overload recovery time

13.10.7 ASCD—AFE Short Circuit in Discharge

Class	Subclass	Name	Type	Min	Max	Default	Unit	Description
Protections	ASCD	Threshold 1	H1	0x00	0xFF	0x77	hex	ASCD: Threshold 1 Setting, Bits 7–4: SCD1D: SCD1 delay time Setting, Bit 3: Reserved Setting, Bits 2–0: SCD1V: SCD1 threshold setting
Protections	ASCD	Threshold 2	H1	0x00	0xFF	0xE7	hex	ASCD: Threshold 2 Setting, Bits 7–4: SCD2D: SCD2 delay time Setting, Bit 3: Reserved Setting, Bits 2–0: SCD2V: SCD2 threshold setting
Protections	ASCD	Recovery	U1	0	255	5	s	Overload recovery time

13.10.8 OTC—Overtemperature in Charge

Class	Subclass	Name	Type	Min	Max	Default	Unit	Description
Protections	OTC	Threshold	I2	–400	1500	550	0.1°C	Overtemperature in Charge trip threshold
Protections	OTC	Delay	U1	0	255	2	s	Overtemperature in Charge Cell trip delay
Protections	OTC	Recovery	I2	–400	1500	500	0.1°C	Overtemperature in Charge Cell recovery threshold

13.10.9 OTD—Overtemperature in Discharge

Class	Subclass	Name	Type	Min	Max	Default	Unit	Description
Protections	OTD	Threshold	I2	–400	1500	600	0.1°C	Overtemperature in Discharge trip threshold
Protections	OTD	Delay	U1	0	255	2	s	Overtemperature in Discharge trip delay
Protections	OTD	Recovery	I2	–400	1500	550	0.1°C	Overtemperature in Discharge recovery threshold

13.10.10 UTC—Under Temperature in Charge

Class	Subclass	Name	Type	Min	Max	Default	Unit	Description
Protections	UTC	Threshold	I2	-400	1500	0	0.1°C	Under Temperature in Charge trip threshold
Protections	UTC	Delay	U1	0	255	2	s	Under Temperature in Charge Cell trip delay
Protections	UTC	Recovery	I2	-400	1500	50	0.1°C	Under Temperature in Charge Cell recovery threshold

13.10.11 UTD—Under Temperature in Discharge

Class	Subclass	Name	Type	Min	Max	Default	Unit	Description
Protections	UTD	Threshold	I2	-400	1500	0	0.1°C	Under Temperature in Discharge trip threshold
Protections	UTD	Delay	U1	0	255	2	s	Under Temperature in Discharge trip delay
Protections	UTD	Recovery	I2	-400	1500	50	0.1°C	Under Temperature in Discharge recovery threshold

13.10.12 PTO—PRECHARGE Mode Time Out

Class	Subclass	Name	Type	Min	Max	Default	Unit	Description
Protections	PTO	Charge Threshold	I2	-32768	32767	2000	mA	Precharge Timeout Current Threshold
Protections	PTO	Suspend Threshold	I2	-32768	32767	1800	mA	Precharge Timeout Suspend Threshold
Protections	PTO	Delay	U2	0	65535	1800	s	Precharge Timeout trip delay
Protections	PTO	Reset	I2	-32768	32767	2	mAh	Precharge Timeout Reset Threshold

13.10.13 CTO—FAST CHARGE Mode Time Out

Class	Subclass	Name	Type	Min	Max	Default	Unit	Description
Protections	CTO	Charge Threshold	I2	-32768	32767	2500	mA	Fast Charge Timeout Current Threshold
Protections	CTO	Suspend Threshold	I2	-32768	32767	2000	mA	Fast Charge Timeout Suspend Threshold
Protections	CTO	Delay	U2	0	65535	54000	s	Fast Charge Timeout trip delay
Protections	CTO	Reset	I2	-32768	32767	2	mAh	Fast Charge Timeout Reset Threshold

13.11 Permanent Fail

13.11.1 SOV—Safety Cell Overvoltage

Class	Subclass	Name	Type	Min	Max	Default	Unit	Description
Permanent Fail	SOV	Threshold	I2	0	32767	4500	mV	Safety Cell Overvoltage trip threshold
Permanent Fail	SOV	Delay	U1	0	255	5	s	Safety Cell Overvoltage trip delay

13.11.2 VIMR—Voltage Imbalance at Rest

Class	Subclass	Name	Type	Min	Max	Default	Unit	Description
Permanent Fail	VIMR	Check Voltage	I2	0	5000	3600	mV	Voltage Imbalance at Rest Check Voltage
Permanent Fail	VIMR	Check Current	I2	0	32767	10	mA	Voltage Imbalance at Rest Check Current
Permanent Fail	VIMR	Delta Threshold	I2	0	5000	200	mV	Voltage Imbalance at Rest Trip Threshold
Permanent Fail	VIMR	Delay	U1	0	255	2	s	Voltage Imbalance at Rest Check Trip Delay
Permanent Fail	VIMR	Duration	U2	0	65535	100	s	Voltage Imbalance at Rest Check Duration

13.11.3 VIMA—Voltage Imbalance Active

Class	Subclass	Name	Type	Min	Max	Default	Unit	Description
Permanent Fail	VIMA	Check Voltage	I2	0	5000	3600	mV	Voltage Imbalance active Check Voltage
Permanent Fail	VIMA	Check Current	I2	0	32767	10	mA	Voltage Imbalance active Check Current
Permanent Fail	VIMA	Delta Threshold	I2	0	5000	300	mV	Voltage Imbalance active trip threshold
Permanent Fail	VIMA	Delay	U1	0	255	2	s	Voltage Imbalance active Check trip delay

13.12 PF Status

The data in this class is saved at the time of the PF event.

13.12.1 Device Status

Class	Subclass	Name	Type	Min	Max	Default	Unit	Description
PF Status	Device Status Data	Safety Alert A	H1	0	FF	0	hex	Accumulated safety flags since PF event
PF Status	Device Status Data	Safety Status A	H1	0	FF	0	hex	Accumulated safety flags since PF event

Name: Safety Alert A or Safety Status A							
Bit 7	Bit 6	Bit 5	Bit 4	Bit 3	Bit 2	Bit 1	Bit 0
RSVD	AOLD	RSVD	OCD	RSVD	OCC	COV	CUV

Class	Subclass	Name	Type	Min	Max	Default	Unit	Description
PF Status	Device Status Data	Safety Alert B	H1	0	FF	0	hex	Accumulated safety flags since PF event
PF Status	Device Status Data	Safety Status B	H1	0	FF	0	hex	Accumulated safety flags since PF event

Name: Safety Alert B or Safety Status B							
Bit 7	Bit 6	Bit 5	Bit 4	Bit 3	Bit 2	Bit 1	Bit 0
RSVD	RSVD	OTD	OTC	RSVD	ASCD	RSVD	ASCC

Class	Subclass	Name	Type	Min	Max	Default	Unit	Description
PF Status	Device Status Data	Safety Alert C	H1	0	FF	0	hex	Accumulated safety flags since PF event
PF Status	Device Status Data	Safety Status C	H1	0	FF	0	hex	Accumulated safety flags since PF event

Name: Safety Alert C or Safety Status C							
Bit 7	Bit 6	Bit 5	Bit 4	Bit 3	Bit 2	Bit 1	Bit 0
RSVD	RSVD	CTOS	RSVD	PTOS	RSVD	RSVD	RSVD

Class	Subclass	Name	Type	Min	Max	Default	Unit	Description
PF Status	Device Status Data	Safety Alert D	H1	0	FF	0	hex	Accumulated safety flags since PF event. All bits in this register are RSVD.
PF Status	Device Status Data	Safety Status D	H1	0	FF	0	hex	Accumulated safety flags since PF event

Name: Safety Status D							
Bit 7	Bit 6	Bit 5	Bit 4	Bit 3	Bit 2	Bit 1	Bit 0
RSVD	RSVD	CTOS	RSVD	PTOS	DFW	RSVD	IFC

Class	Subclass	Name	Type	Min	Max	Default	Unit	Description
PF Status	Device Status Data	Operation Status A	H2	0	FFFF	0	hex	<i>OperationStatus()</i> data at the time of the PF event

Name: Operation Status A															
Bit 15	Bit 14	Bit 13	Bit 12	Bit 11	Bit 10	Bit 9	Bit 8	Bit 7	Bit 6	Bit 5	Bit 4	Bit 3	Bit 2	Bit 1	Bit 0
RSVD	RSVD	RSVD	RSVD	PCHG	CHG	DSG	RSVD	SLEEP	XCHG	XDSG	PF	SS	SDV	SEC1	SEC0

Class	Subclass	Name	Type	Min	Max	Default	Unit	Description
PF Status	Device Status Data	Operation Status B	H2	0	FFFF	0	hex	<i>OperationStatus()</i> data at the time of the PF event

Name: Operation Status B															
Bit 15	Bit 14	Bit 13	Bit 12	Bit 11	Bit 10	Bit 9	Bit 8	Bit 7	Bit 6	Bit 5	Bit 4	Bit 3	Bit 2	Bit 1	Bit 0
SLEEP M	XL	CAL_OF FSET	CAL	AUTO CALM	AUTH	LED	SDM	RSVD	RSVD	RSVD	CB	SLPCC	SLPAD	SMBL CAL	INIT

Class	Subclass	Name	Type	Min	Max	Default	Unit	Description
PF Status	Device Status Data	Temp Range	H1	0	FF	0	hex	Temperature range status at the time of the PF event. The temperature range information is returned to <i>ChargingStatus()</i> .

Name: Temp Range							
Bit 7	Bit 6	Bit 5	Bit 4	Bit 3	Bit 2	Bit 1	Bit 0
RSVD	OT	HT	STH	RT	SLT	LT	UT

Class	Subclass	Name	Type	Min	Max	Default	Unit	Description
PF Status	Device Status Data	Charging Status A	H1	0	FF	0	hex	The charging status at the time of the PF event. See section under <i>AltManufacturerAccess()</i> , <i>Gauging Status()</i> .

Name: Charging Status A							
Bit 7	Bit 6	Bit 5	Bit 4	Bit 3	Bit 2	Bit 1	Bit 0
VCT	MCHG	SU	IN	HV	MV	LV	PV

Class	Subclass	Name	Type	Min	Max	Default	Unit	Description
PF Status	Device Status Data	Gauging Status	H1	0	FF	0	hex	The charging status at the time of the PF event. See section under <i>AltManufacturerAccess()</i> , <i>Gauging Status()</i> .

Name: Gauging Status							
Bit 7	Bit 6	Bit 5	Bit 4	Bit 3	Bit 2	Bit 1	Bit 0
VCT	MCHG	SU	IN	HV	MV	LV	PV

Class	Subclass	Name	Type	Min	Max	Default	Unit	Description
PF Status	Device Status Data	IT Status	H2	0	FFFF	0	hex	The Impedance Track status at the time of the PF event. See section under <i>AltManufacturerAccess()</i> , <i>Gauging Status()</i> .

Name: IT Status															
Bit 15	Bit 14	Bit 13	Bit 12	Bit 11	Bit 10	Bit 9	Bit 8	Bit 7	Bit 6	Bit 5	Bit 4	Bit 3	Bit 2	Bit 1	Bit 0
NSFM	RSVD	SLPQM _{ax}	QEN	VOK	RDIS	RSVD	REST	RSVD	RSVD	RSVD	OCVFR	LDMD	RX	QMax	VDQ

13.12.2 Device Voltage Data

Class	Subclass	Name	Type	Min	Max	Default	Unit	Description
PF Status	Device Voltage Data	Cell Voltage 0	I2	-32768	32767	0	mV	Cell 0 voltage
PF Status	Device Voltage Data	Cell Voltage 1	I2	-32768	32767	0	mV	Cell 1 voltage
PF Status	Device Voltage Data	Bat Direct Voltage	I2	-32768	32767	0	mV	Cell stack voltage
PF Status	Device Voltage Data	Pack Voltage	I2	-32768	32767	0	mV	Pack terminal voltage

13.12.3 Device Current Data

Class	Subclass	Name	Type	Min	Max	Default	Unit	Description
PF Status	Device Current Data	Current	I2	-32768	32767	0	mA	<i>Current()</i>

13.12.4 Device Temperature Data

Class	Subclass	Name	Type	Min	Max	Default	Unit	Description
PF Status	Device Temperature Data	Internal Temperature	I2	-32768	32767	0	0.1°K	Internal temperature sensor Temperature
PF Status	Device Temperature Data	External 1 Temperature	I2	-32768	32767	0	0.1°K	External TS1 Temperature

13.12.5 Device Gauging Data

Class	Subclass	Name	Type	Min	Max	Default	Unit	Description
PF Status	Device Gauging Data	Cell 0 DOD0	I2	-32768	32767	0		Cell 0 depth of discharge
PF Status	Device Gauging Data	Cell 1 DOD0	I2	-32768	32767	0		Cell 1 depth of discharge
PF Status	Device Gauging Data	Passed Charge	I2	-32768	32767	0	mAh	Passed charge since last QMax update

13.12.6 AFE Registers

Class	Subclass	Name	Type	Min	Max	Default	Description
PF Status	AFE Regs	AFE Interrupt Status	H1	0x00	0xFF	0x00	AFE Interrupt Status Register Contents
PF Status	AFE Regs	AFE FET Status	H1	0x00	0xFF	0x00	AFE FET Status Register Contents
PF Status	AFE Regs	AFE Rxin	H1	0x00	0xFF	0x00	AFE Rxin Register Contents
PF Status	AFE Regs	AFE Interrupt Enable	H1	0x00	0xFF	0x00	AFE Interrupt Enable Register Contents
PF Status	AFE Regs	AFE FET Control	H1	0x00	0xFF	0x00	AFE FET Control Register Contents
PF Status	AFE Regs	AFE RXIEN	H1	0x00	0xFF	0x00	AFE RXIEN Register Contents
PF Status	AFE Regs	AFE RLOUT	H1	0x00	0xFF	0x00	AFE RLOUT Register Contents
PF Status	AFE Regs	AFE RHOUT	H1	0x00	0xFF	0x00	AFE RHOUT Register Contents
PF Status	AFE Regs	AFE RHINT	H1	0x00	0xFF	0x00	AFE RHINT Register Contents
PF Status	AFE Regs	AFE Cell Balance	H1	0x00	0xFF	0x00	AFE Cell Balance Register Contents
PF Status	AFE Regs	AFE AD/CC Control	H1	0x00	0xFF	0x00	AFE AD/CC Control Register Contents
PF Status	AFE Regs	AFE ADC Mux	H1	0x00	0xFF	0x00	AFE ADC Mux Register Contents
PF Status	AFE Regs	AFE State Control	H1	0x00	0xFF	0x00	AFE State Control Register Contents
PF Status	AFE Regs	AFE Wake Control	H1	0x00	0xFF	0x00	AFE Wake Control Register Contents
PF Status	AFE Regs	AFE Protection Control	H1	0x00	0xFF	0x00	AFE Protection Control Register Contents
PF Status	AFE Regs	AFE OCD	H1	0x00	0xFF	0x00	AFE OCD Register Contents
PF Status	AFE Regs	AFE SCC	H1	0x00	0xFF	0x00	AFE SCC Register Contents
PF Status	AFE Regs	AFE SCD1	H1	0x00	0xFF	0x00	AFE SCD1 Register Contents
PF Status	AFE Regs	AFE SCD2	H1	0x00	0xFF	0x00	AFE SCD2 Register Contents

13.13 RA Table

13.13.1 R_a0

Class	Subclass	Name	Type	Min	Max	Default	Unit	Description
RA Table	R_a0	Cell 0 R_A Flag	H2	0x0000	0xFFFF	0xFF55		High Byte: 0x00: Cell Impedance and QMax updated 0x05: RELAX mode and QMax update in progress 0x55: DISCHARGE mode and cell updated 0xFF: Cell impedance never updated Low-Byte: 0x00: Table not used and QMax updated 0x55: Table being used 0xFF: Table never used, no QMax or cell impedance update
RA Table	R_a0	Cell 0 R_A 0	I2	-32768	32768	38	2 ⁻¹⁰ Ω	Cell 0 resistance at grid point 0
RA Table	R_a0	Cell 0 R_A 1	I2	-32768	32768	41	2 ⁻¹⁰ Ω	Cell 0 resistance at grid point 1
RA Table	R_a0	Cell 0 R_A 2	I2	-32768	32768	43	2 ⁻¹⁰ Ω	Cell 0 resistance at grid point 2
RA Table	R_a0	Cell 0 R_A 3	I2	-32768	32768	44	2 ⁻¹⁰ Ω	Cell 0 resistance at grid point 3
RA Table	R_a0	Cell 0 R_A 4	I2	-32768	32768	42	2 ⁻¹⁰ Ω	Cell 0 resistance at grid point 4
RA Table	R_a0	Cell 0 R_A 5	I2	-32768	32768	42	2 ⁻¹⁰ Ω	Cell 0 resistance at grid point 5
RA Table	R_a0	Cell 0 R_A 6	I2	-32768	32768	45	2 ⁻¹⁰ Ω	Cell 0 resistance at grid point 6
RA Table	R_a0	Cell 0 R_A 7	I2	-32768	32768	48	2 ⁻¹⁰ Ω	Cell 0 resistance at grid point 7
RA Table	R_a0	Cell 0 R_A 8	I2	-32768	32768	49	2 ⁻¹⁰ Ω	Cell 0 resistance at grid point 8
RA Table	R_a0	Cell 0 R_A 9	I2	-32768	32768	52	2 ⁻¹⁰ Ω	Cell 0 resistance at grid point 9
RA Table	R_a0	Cell 0 R_A 10	I2	-32768	32768	56	2 ⁻¹⁰ Ω	Cell 0 resistance at grid point 10
RA Table	R_a0	Cell 0 R_A 11	I2	-32768	32768	64	2 ⁻¹⁰ Ω	Cell 0 resistance at grid point 11
RA Table	R_a0	Cell 0 R_A 12	I2	-32768	32768	74	2 ⁻¹⁰ Ω	Cell 0 resistance at grid point 12
RA Table	R_a0	Cell 0 R_A 13	I2	-32768	32768	128	2 ⁻¹⁰ Ω	Cell 0 resistance at grid point 13
RA Table	R_a0	Cell 0 R_A 14	I2	-32768	32768	378	2 ⁻¹⁰ Ω	Cell 0 resistance at grid point 14

13.13.2 R_a1

Class	Subclass	Name	Type	Min	Max	Default	Unit	Description
RA Table	R_a1	Cell 1 R_A Flag	H2	0x0000	0xFFFF	0xFF55		High-Byte: 0x00: Cell Impedance and QMax updated 0x05: RELAX mode and QMax update in progress 0x55: DISCHARGE mode and cell updated 0xFF: cell impedance never updated Low-Byte: 0x00: Table not used and QMax updated 0x55: Table being used 0xFF: Table never used, no QMax or cell impedance update
RA Table	R_a1	Cell 1 R_A 0	I2	-32768	32768	38	2 ⁻¹⁰ Ω	Cell 1 resistance at grid point 0
RA Table	R_a1	Cell 1 R_A 1	I2	-32768	32768	41	2 ⁻¹⁰ Ω	Cell 1 resistance at grid point 1
RA Table	R_a1	Cell 1 R_A 2	I2	-32768	32768	43	2 ⁻¹⁰ Ω	Cell 1 resistance at grid point 2
RA Table	R_a1	Cell 1 R_A 3	I2	-32768	32768	44	2 ⁻¹⁰ Ω	Cell 1 resistance at grid point 3
RA Table	R_a1	Cell 1 R_A 4	I2	-32768	32768	42	2 ⁻¹⁰ Ω	Cell 1 resistance at grid point 4
RA Table	R_a1	Cell 1 R_A 5	I2	-32768	32768	42	2 ⁻¹⁰ Ω	Cell 1 resistance at grid point 5
RA Table	R_a1	Cell 1 R_A 6	I2	-32768	32768	45	2 ⁻¹⁰ Ω	Cell 1 resistance at grid point 6
RA Table	R_a1	Cell 1 R_A 7	I2	-32768	32768	48	2 ⁻¹⁰ Ω	Cell 1 resistance at grid point 7
RA Table	R_a1	Cell 1 R_A 8	I2	-32768	32768	49	2 ⁻¹⁰ Ω	Cell 1 resistance at grid point 8
RA Table	R_a1	Cell 1 R_A 9	I2	-32768	32768	52	2 ⁻¹⁰ Ω	Cell 1 resistance at grid point 9
RA Table	R_a1	Cell 1 R_A 10	I2	-32768	32768	56	2 ⁻¹⁰ Ω	Cell 1 resistance at grid point 10
RA Table	R_a1	Cell 1 R_A 11	I2	-32768	32768	64	2 ⁻¹⁰ Ω	Cell 1 resistance at grid point 11
RA Table	R_a1	Cell 1 R_A 12	I2	-32768	32768	74	2 ⁻¹⁰ Ω	Cell 1 resistance at grid point 12
RA Table	R_a1	Cell 1 R_A 13	I2	-32768	32768	128	2 ⁻¹⁰ Ω	Cell 1 resistance at grid point 13
RA Table	R_a1	Cell 1 R_A 14	I2	-32768	32768	378	2 ⁻¹⁰ Ω	Cell 1 resistance at grid point 14

13.13.3 R_a0x

Class	Subclass	Name	Type	Min	Max	Default	Unit	Description
RA Table	R_a0x	xCell 0 R_A Flag	H2	0x0000	0xFFFF	0xFFFF		High-Byte: 0x00: Cell Impedance and QMax updated 0x05: RELAX mode and QMax update in progress 0x55: DISCHARGE mode and cell updated 0xFF: Cell impedance never updated. Low-Byte: 0x00: Table is not used and QMax updated. 0x55: Table is being used. 0xFF: Table was never used and no QMax or cell impedance was updated.
RA Table	R_a0x	xCell 0 R_A 0	I2	-32768	32768	38	2 ⁻¹⁰ Ω	Cell 0 resistance at grid point 0
RA Table	R_a0x	xCell 0 R_A 1	I2	-32768	32768	41	2 ⁻¹⁰ Ω	Cell 0 resistance at grid point 1
RA Table	R_a0x	xCell 0 R_A 2	I2	-32768	32768	43	2 ⁻¹⁰ Ω	Cell 0 resistance at grid point 2
RA Table	R_a0x	xCell 0 R_A 3	I2	-32768	32768	44	2 ⁻¹⁰ Ω	Cell 0 resistance at grid point 3
RA Table	R_a0x	xCell 0 R_A 4	I2	-32768	32768	42	2 ⁻¹⁰ Ω	Cell 0 resistance at grid point 4
RA Table	R_a0x	xCell 0 R_A 5	I2	-32768	32768	42	2 ⁻¹⁰ Ω	Cell 0 resistance at grid point 5
RA Table	R_a0x	xCell 0 R_A 6	I2	-32768	32768	45	2 ⁻¹⁰ Ω	Cell 0 resistance at grid point 6
RA Table	R_a0x	xCell 0 R_A 7	I2	-32768	32768	48	2 ⁻¹⁰ Ω	Cell 0 resistance at grid point 7
RA Table	R_a0x	xCell 0 R_A 8	I2	-32768	32768	49	2 ⁻¹⁰ Ω	Cell 0 resistance at grid point 8
RA Table	R_a0x	xCell 0 R_A 9	I2	-32768	32768	52	2 ⁻¹⁰ Ω	Cell 0 resistance at grid point 9
RA Table	R_a0x	xCell 0 R_A 10	I2	-32768	32768	56	2 ⁻¹⁰ Ω	Cell 0 resistance at grid point 10
RA Table	R_a0x	xCell 0 R_A 11	I2	-32768	32768	64	2 ⁻¹⁰ Ω	Cell 0 resistance at grid point 11
RA Table	R_a0x	xCell 0 R_A 12	I2	-32768	32768	74	2 ⁻¹⁰ Ω	Cell 0 resistance at grid point 12
RA Table	R_a0x	xCell 0 R_A 13	I2	-32768	32768	128	2 ⁻¹⁰ Ω	Cell 0 resistance at grid point 13
RA Table	R_a0x	xCell 0 R_A 14	I2	-32768	32768	378	2 ⁻¹⁰ Ω	Cell 0 resistance at grid point 14

13.13.4 R_a1x

Class	Subclass	Name	Type	Min	Max	Default	Unit	Description
RA Table	R_a1x	xCell 1 R_A Flag	H2	0x0000	0xFFFF	0xFFFF		High-Byte: 0x00: Cell Impedance and QMax updated 0x05: RELAX mode and QMax update in progress 0x55: DISCHARGE mode and Cell updated 0xFF: Cell impedance never updated Low-Byte: 0x00: Table is not used and QMax updated. 0x55: Table is being used. 0xFF: Table was never used and no QMax or cell impedance was updated.
RA Table	R_a1x	xCell 1 R_A 0	I2	-32768	32768	38	2 ⁻¹⁰ Ω	Cell 1 resistance at grid point 0
RA Table	R_a1x	xCell 1 R_A 1	I2	-32768	32768	41	2 ⁻¹⁰ Ω	Cell 1 resistance at grid point 1
RA Table	R_a1x	xCell 1 R_A 2	I2	-32768	32768	43	2 ⁻¹⁰ Ω	Cell 1 resistance at grid point 2
RA Table	R_a1x	xCell 1 R_A 3	I2	-32768	32768	44	2 ⁻¹⁰ Ω	Cell 1 resistance at grid point 3
RA Table	R_a1x	xCell 1 R_A 4	I2	-32768	32768	42	2 ⁻¹⁰ Ω	Cell 1 resistance at grid point 4
RA Table	R_a1x	xCell 1 R_A 5	I2	-32768	32768	42	2 ⁻¹⁰ Ω	Cell 1 resistance at grid point 5
RA Table	R_a1x	xCell 1 R_A 6	I2	-32768	32768	45	2 ⁻¹⁰ Ω	Cell 1 resistance at grid point 6
RA Table	R_a1x	xCell 1 R_A 7	I2	-32768	32768	48	2 ⁻¹⁰ Ω	Cell 1 resistance at grid point 7
RA Table	R_a1x	xCell 1 R_A 8	I2	-32768	32768	49	2 ⁻¹⁰ Ω	Cell 1 resistance at grid point 8
RA Table	R_a1x	xCell 1 R_A 9	I2	-32768	32768	52	2 ⁻¹⁰ Ω	Cell 1 resistance at grid point 9
RA Table	R_a1x	xCell 1 R_A 10	I2	-32768	32768	56	2 ⁻¹⁰ Ω	Cell 1 resistance at grid point 10
RA Table	R_a1x	xCell 1 R_A 11	I2	-32768	32768	64	2 ⁻¹⁰ Ω	Cell 1 resistance at grid point 11
RA Table	R_a1x	xCell 1 R_A 12	I2	-32768	32768	74	2 ⁻¹⁰ Ω	Cell 1 resistance at grid point 12
RA Table	R_a1x	xCell 1 R_A 13	I2	-32768	32768	128	2 ⁻¹⁰ Ω	Cell 1 resistance at grid point 13
RA Table	R_a1x	xCell 1 R_A 14	I2	-32768	32768	378	2 ⁻¹⁰ Ω	Cell 1 resistance at grid point 14

Data Flash Summary

14.1 Data Flash Table

Table 14-1. Data Flash Table

Class	Subclass	Address	Name	Type	Min Value	Max Value	Default	Units
Calibration	Voltage	0x4000	Cell Gain	I2	–32767	32767	12101	—
Calibration	Voltage	0x4002	Pack Gain	U2	0	65535	49669	—
Calibration	Voltage	0x4004	BAT Gain	U2	0	65535	48936	—
Calibration	Current	0x4006	CC Gain	F4	1.00E–01	4.00E+00	3.58422	—
Calibration	Current	0x400A	Capacity Gain	F4	2.98262E+04	1.193046E+06	1069035.256	—
Calibration	Current Offset	0x400E	CC Offset	I2	–32767	32767	0	—
Calibration	Current Offset	0x4010	Coulomb Counter Offset Samples	U2	0	65535	64	—
Calibration	Current Offset	0x4012	Board Offset	I2	–32768	32767	0	—
Calibration	Current Offset	0x40C0	CC Auto Config	H1	0x00	0x07	0x03	Hex
Calibration	Current Offset	0x40C1	CC Auto Offset	I2	–10000	10000	0	—
Calibration	Temperature	0x4014	Internal Temp Offset	I1	–128	127	0	0.1°C
Calibration	Temperature	0x4015	External1 Temp Offset	I1	–128	127	0	0.1°C
Calibration	Internal Temp Model	0x4400	Int Gain	I2	–32768	32767	–12143	—
Calibration	Internal Temp Model	0x4402	Int base offset	I2	–32768	32767	6232	—
Calibration	Internal Temp Model	0x4404	Int Minimum AD	I2	–32768	32767	0	—
Calibration	Internal Temp Model	0x4406	Int Maximum Temp	I2	–32768	32767	6232	0.1°K
Calibration	Cell Temperature Model	0x4408	Coeff a1	I2	–32768	32767	–11130	—
Calibration	Cell Temperature Model	0x440A	Coeff a2	I2	–32768	32767	19142	—
Calibration	Cell Temperature Model	0x440C	Coeff a3	I2	–32768	32767	–19262	—
Calibration	Cell Temperature Model	0x440E	Coeff a4	I2	–32768	32767	28203	—
Calibration	Cell Temperature Model	0x4410	Coeff a5	I2	–32768	32767	892	—
Calibration	Cell Temperature Model	0x4412	Coeff b1	I2	–32768	32767	328	—
Calibration	Cell Temperature Model	0x4414	Coeff b2	I2	–32768	32767	–605	—
Calibration	Cell Temperature Model	0x4416	Coeff b3	I2	–32768	32767	–2443	—
Calibration	Cell Temperature Model	0x4418	Coeff b4	I2	–32768	32767	4696	—
Calibration	Cell Temperature Model	0x441A	Rc0	I2	–32768	32767	11703	—
Calibration	Cell Temperature Model	0x441C	Adc0	I2	–32768	32767	11703	—
Calibration	Cell Temperature Model	0x441E	Rpad	I2	–32768	32767	0	—

Table 14-1. Data Flash Table (continued)

Class	Subclass	Address	Name	Type	Min Value	Max Value	Default	Units
Calibration	Cell Temperature Model	0x4420	Rint	I2	-32768	32767	0	—
Calibration	Current Deadband	0x4446	Deadband	U1	0	255	3	mA
Calibration	Current Deadband	0x4447	Coulomb Counter Deadband	U1	0	255	9	116 nV
Settings	Protection	0x46AE	Protection Configuration	H1	0x0	0x03	0x0	Hex
Settings	Protection	0x46AF	Enabled Protections A	H1	0x0	0xFF	0x57	Hex
Settings	Protection	0x46B0	Enabled Protections B	H1	0x0	0xFF	0x35	Hex
Settings	Protection	0x46B1	Enabled Protections C	H1	0x0	0xFF	0x14	Hex
Settings	Protection	0x46B2	Enabled Protections D	H1	0x0	0xFF	0x0C	Hex
Settings	Permanent Failure	0x46FC	Enabled PF A	H1	0x0	0xFF	0x0	Hex
Settings	Permanent Failure	0x46FD	Enabled PF B	H1	0x0	0xFF	0x0	Hex
Settings	Permanent Failure	0x46FE	Enabled PF C	H1	0x0	0xFF	0x0	Hex
Settings	Configuration	0x4600	FET Options	H1	0x0	0xFF	0x20	Hex
Settings	Configuration	0x4601	I2C Gauging Configuration	H1	0x0	0x0F	0x04	Hex
Settings	Configuration	0x4602	I2C Configuration	H1	0x0	0xFF	0x01	Hex
Settings	Configuration	0x4604	Power Config	H1	0x0	0xBF	0x00	Hex
Settings	Configuration	0x4605	IO Config	H1	0x0	0x03	0x02	Hex
Settings	Configuration	0x4632	SOC Flag Config A	H2	0x0	0x0FFF	0x0C8C	Hex
Settings	Configuration	0x4634	SOC Flag Config B	H1	0x0	0xFF	0x8C	Hex
Settings	Configuration	0x464D	IT Gauging Configuration	H2	0x0	0xFFFF	0x14CE	Hex
Settings	Configuration	0x465E	Charging Configuration	H1	0x0	0x3F	0x0	Hex
Settings	Configuration	0x469A	Temperature Enable	H1	0x0	0x03	0x03	Hex
Settings	Configuration	0x469B	DA Configuration	H1	0x0	0xFF	0x11	Hex
Settings	Configuration	0x470A	Balancing Configuration	H1	0x0	0xFF	0x01	Hex
Settings	AFE	0x469D	AFE Protection Control	H1	0x0	0xFF	0x70	Hex
Settings	AFE	0x46A3	ZVCHG Exit Threshold	I2	0	8000	2200	mV
Settings	BTP	0x4606	Init Discharge Set	I2	0	32767	150	mAh
Settings	BTP	0x4608	Init Charge Set	I2	0	32767	175	mAh
Settings	Charger	0x4624	Device Address	H1	0x0	0xFF	0xD4	Hex
Settings	Charger	0x4625	Voltage Register	H1	0x0	0xFF	0x0C	Hex
Settings	Charger	0x4626	Current Register	H1	0x0	0xFF	0x0A	Hex
Settings	Charger	0x4629	Broadcast Pacing	U1	0	255	15	s
Settings	Manufacturing	0x43C0	Mfg Status init	H2	0x0	0xFFFF	0x0000	Hex
Protections	CUV	0x46B3	Threshold	I2	0	32767	2500	mV
Protections	CUV	0x46B5	Delay	U1	0	255	2	s
Protections	CUV	0x46B6	Recovery	I2	0	32767	3000	mV
Protections	COV	0x46B8	Threshold Low Temp	I2	0	32767	4300	mV
Protections	COV	0x46BA	Threshold Standard Temp	I2	0	32767	4300	mV
Protections	COV	0x46BC	Threshold High Temp	I2	0	32767	4300	mV
Protections	COV	0x46BE	Threshold Rec Temp	I2	0	32767	4300	mV
Protections	COV	0x46C0	Delay	U1	0	255	2	s
Protections	COV	0x46C1	Recovery Low Temp	I2	0	32767	3900	mV
Protections	COV	0x46C3	Recovery Standard Temp	I2	0	32767	3900	mV
Protections	COV	0x46C5	Recovery High Temp	I2	0	32767	3900	mV
Protections	COV	0x46C7	Recovery Rec Temp	I2	0	32767	3900	mV
Protections	OCC	0x46C9	Threshold	I2	-32768	32767	6000	mA
Protections	OCC	0x46CB	Delay	U1	0	255	6	s
Protections	OCC	0x46CC	Recovery Threshold	I2	-32768	32767	-200	mA
Protections	OCC	0x46CE	Recovery Delay	U1	0	255	5	s
Protections	OCD	0x46CF	Threshold	I2	-32768	32767	-6000	mA
Protections	OCD	0x46D1	Delay	U1	0	255	6	s
Protections	OCD	0x46D2	Recovery Threshold	I2	-32768	32767	200	mA

Table 14-1. Data Flash Table (continued)

Class	Subclass	Address	Name	Type	Min Value	Max Value	Default	Units
Protections	OCD	0x46D4	Recovery Delay	U1	0	255	5	s
Protections	AOLD	0x469E	Threshold	H1	0x0	0xFF	0xF4	Hex
Protections	AOLD	0x46D5	Recovery	U1	0	255	5	s
Protections	ASCC	0x469F	Threshold	H1	0x0	0xFF	0x77	Hex
Protections	ASCC	0x46D6	Recovery	U1	0	255	5	s
Protections	ASCD	0x46A0	Threshold 1	H1	0x0	0xFF	0x77	Hex
Protections	ASCD	0x46A1	Threshold 2	H1	0x0	0xFF	0xE7	Hex
Protections	ASCD	0x46D7	Recovery	U1	0	255	5	s
Protections	OTC	0x46D8	Threshold	I2	-400	1500	550	0.1°C
Protections	OTC	0x46DA	Delay	U1	0	255	2	s
Protections	OTC	0x46DB	Recovery	I2	-400	1500	500	0.1°C
Protections	OTD	0x46DD	Threshold	I2	-400	1500	600	0.1°C
Protections	OTD	0x46DF	Delay	U1	0	255	2	s
Protections	OTD	0x46E0	Recovery	I2	-400	1500	550	0.1°C
Protections	UTC	0x46E2	Threshold	I2	-400	1500	0	0.1°C
Protections	UTC	0x46E4	Delay	U1	0	255	2	s
Protections	UTC	0x46E5	Recovery	I2	-400	1500	50	0.1°C
Protections	UTD	0x46E7	Threshold	I2	-400	1500	0	0.1°C
Protections	UTD	0x46E9	Delay	U1	0	255	2	s
Protections	UTD	0x46EA	Recovery	I2	-400	1500	50	0.1°C
Protections	PTO	0x46EC	Charge Threshold	I2	-32768	32767	2000	mA
Protections	PTO	0x46EE	Suspend Threshold	I2	-32768	32767	1800	mA
Protections	PTO	0x46F0	Delay	U2	0	65535	1800	s
Protections	PTO	0x46F2	Reset	I2	0	32767	2	mAh
Protections	CTO	0x46F4	Charge Threshold	I2	-32768	32767	2500	mA
Protections	CTO	0x46F6	Suspend Threshold	I2	-32768	32767	2000	mA
Protections	CTO	0x46F8	Delay	U2	0	65535	54000	s
Protections	CTO	0x46FA	Reset	I2	0	32767	2	mAh
Permanent Fail	SOV	0x4700	Threshold	I2	0	32767	4500	mV
Permanent Fail	SOV	0x4702	Delay	U1	0	255	5	s
Permanent Fail	CFET	0x4703	OFF Threshold	I2	0	500	5	mA
Permanent Fail	CFET	0x4705	OFF Delay	U1	0	255	5	s
Permanent Fail	DFET	0x4706	OFF Threshold	I2	-500	0	-5	mA
Permanent Fail	DFET	0x4708	OFF Delay	U1	0	255	5	s
Permanent Fail	VIMR	0x4715	Check Voltage	I2	0	5000	3500	mV
Permanent Fail	VIMR	0x4715	Check Current	I2	0	32767	10	mA
Permanent Fail	VIMR	0x4717	Delta Threshold	I2	0	5000	500	mV
Permanent Fail	VIMR	0x4719	Delta Delay	U1	0	255	5	s
Permanent Fail	VIMR	0x471A	Duration	U2	0	65535	100	s
Permanent Fail	VIMA	0x471C	Check Voltage	I2	0	5000	3700	mV
Permanent Fail	VIMA	0x471E	Check Current	I2	0	32767	50	mA
Permanent Fail	VIMA	0x4720	Delta Threshold	I2	0	5000	200	mV
Permanent Fail	VIMA	0x4722	Delta Delay	U1	0	255	5	s
Advanced Charge Algorithm	Temperature Ranges	0x465F	T1 Temp	I1	-128	127	0	°C
Advanced Charge Algorithm	Temperature Ranges	0x4660	T2 Temp	I1	-128	127	12	°C
Advanced Charge Algorithm	Temperature Ranges	0x4661	T5 Temp	I1	-128	127	20	°C
Advanced Charge Algorithm	Temperature Ranges	0x4662	T6 Temp	I1	-128	127	25	°C
Advanced Charge Algorithm	Temperature Ranges	0x4663	T3 Temp	I1	-128	127	30	°C

Table 14-1. Data Flash Table (continued)

Class	Subclass	Address	Name	Type	Min Value	Max Value	Default	Units
Advanced Charge Algorithm	Temperature Ranges	0x4664	T4 Temp	I1	-128	127	55	°C
Advanced Charge Algorithm	Temperature Ranges	0x4665	Hysteresis Temp	I1	0	127	1	°C
Advanced Charge Algorithm	Low Temp Charging	0x4666	Voltage	I2	0	32767	4000	mV
Advanced Charge Algorithm	Low Temp Charging	0x4668	Current Low	I2	0	32767	132	mA
Advanced Charge Algorithm	Low Temp Charging	0x466A	Current Med	I2	0	32767	352	mA
Advanced Charge Algorithm	Low Temp Charging	0x466C	Current High	I2	0	32767	264	mA
Advanced Charge Algorithm	Standard Temp Charging	0x466E	Voltage	I2	0	32767	4200	mV
Advanced Charge Algorithm	Standard Temp Charging	0x4670	Current Low	I2	0	32767	1980	mA
Advanced Charge Algorithm	Standard Temp Charging	0x4672	Current Med	I2	0	32767	4004	mA
Advanced Charge Algorithm	Standard Temp Charging	0x4674	Current High	I2	0	32767	2992	mA
Advanced Charge Algorithm	High Temp Charging	0x4676	Voltage	I2	0	32767	4000	mV
Advanced Charge Algorithm	High Temp Charging	0x4678	Current Low	I2	0	32767	1012	mA
Advanced Charge Algorithm	High Temp Charging	0x467A	Current Med	I2	0	32767	1980	mA
Advanced Charge Algorithm	High Temp Charging	0x467C	Current High	I2	0	32767	1496	mA
Advanced Charge Algorithm	Rec Temp Charging	0x467E	Voltage	I2	0	32767	4100	mV
Advanced Charge Algorithm	Rec Temp Charging	0x4680	Current Low	I2	0	32767	2508	mA
Advanced Charge Algorithm	Rec Temp Charging	0x4682	Current Med	I2	0	32767	4488	mA
Advanced Charge Algorithm	Rec Temp Charging	0x4684	Current High	I2	0	32767	3520	mA
Advanced Charge Algorithm	Pre-Charging	0x4686	Current	I2	0	32767	88	mA
Advanced Charge Algorithm	Maintenance Charging	0x4688	Current	I2	0	32767	44	mA
Advanced Charge Algorithm	Voltage Range	0x468A	Precharge Start Voltage	I2	0	32767	2500	mV
Advanced Charge Algorithm	Voltage Range	0x468C	Charging Voltage Low	I2	0	32767	2900	mV
Advanced Charge Algorithm	Voltage Range	0x468E	Charging Voltage Med	I2	0	32767	3600	mV
Advanced Charge Algorithm	Voltage Range	0x4690	Charging Voltage High	I2	0	32767	4000	mV
Advanced Charge Algorithm	Voltage Range	0x4692	Charging Voltage Hysteresis	U1	0	255	0	mV
Advanced Charge Algorithm	Termination Config	0x4693	Charge Term Taper Current	I2	0	32767	250	mA
Advanced Charge Algorithm	Termination Config	0x4697	Charge Term Voltage	I2	0	32767	75	mV
Advanced Charge Algorithm	Cell Balancing Config	0x470B	Bal Time/mAh Cell 1	U2	0	65535	354	s/mAh
Advanced Charge Algorithm	Cell Balancing Config	0x470D	Bal Time/mAh Cell 2	U2	0	65535	361	s/mAh
Advanced Charge Algorithm	Cell Balancing Config	0x470F	Min Start Balance Delta	U1	0	255	3	mV
Advanced Charge Algorithm	Cell Balancing Config	0x4710	Relax Balance Interval	U4	0	429496729 5	18000	s

Table 14-1. Data Flash Table (continued)

Class	Subclass	Address	Name	Type	Min Value	Max Value	Default	Units
Advanced Charge Algorithm	Cell Balancing Config	0x4714	Min Rsoc for Balancing	U1	0	100	80	%
Gas Gauging	Current Thresholds	0x46A6	Dsg Current Threshold	I2	-32768	32767	100	mA
Gas Gauging	Current Thresholds	0x46A8	Chg Current Threshold	I2	-32768	32767	50	mA
Gas Gauging	Current Thresholds	0x46AA	Quit Current	I2	0	32767	10	mA
Gas Gauging	Current Thresholds	0x46AC	Dsg Relax Time	U1	0	255	1	s
Gas Gauging	Current Thresholds	0x46AD	Chg Relax Time	U1	0	255	60	s
Gas Gauging	Standby	0x461D	StandbyCurrent	I2	-32768	0	-10	mA
Gas Gauging	Max Load	0x461F	Max Load Current	I2	-32768	0	-500	mA
Gas Gauging	Max Load	0x4621	Max Load Rsoc	U1	0	100	50	%
Gas Gauging	Design	0x462A	Design Capacity mAh	I2	0	32767	4400	mAh
Gas Gauging	Design	0x462C	Design Capacity cWh	I2	0	32767	6336	cWh
Gas Gauging	Design	0x462E	Design Voltage	I2	0	32767	7200	mV
Gas Gauging	Cycle	0x4630	Cycle Count Percentage	U1	0	100	90	%
Gas Gauging	FD	0x4635	Set Voltage Threshold	I2	0	5000	3000	mV
Gas Gauging	FD	0x4637	Clear Voltage Threshold	I2	0	5000	3100	mV
Gas Gauging	FD	0x4639	Set % RSOC Threshold	U1	0	100	0	%
Gas Gauging	FD	0x463A	Clear % RSOC Threshold	U1	0	100	5	%
Gas Gauging	FC	0x463B	Set Voltage Threshold	I2	0	5000	4200	mV
Gas Gauging	FC	0x463D	Clear Voltage Threshold	I2	0	5000	4100	mV
Gas Gauging	FC	0x463F	Set % RSOC Threshold	U1	0	100	100	%
Gas Gauging	FC	0x4640	Clear % RSOC Threshold	U1	0	100	95	%
Gas Gauging	TD	0x4641	Set Voltage Threshold	I2	0	5000	3200	mV
Gas Gauging	TD	0x4643	Clear Voltage Threshold	I2	0	5000	3300	mV
Gas Gauging	TD	0x4645	Set % RSOC Threshold	U1	0	100	6	%
Gas Gauging	TD	0x4646	Clear % RSOC Threshold	U1	0	100	8	%
Gas Gauging	TC	0x4647	Set Voltage Threshold	I2	0	5000	4200	mV
Gas Gauging	TC	0x4649	Clear Voltage Threshold	I2	0	5000	4100	mV
Gas Gauging	TC	0x464B	Set % RSOC Threshold	U1	0	100	100	%
Gas Gauging	TC	0x464C	Clear % RSOC Threshold	U1	0	100	95	%
Gas Gauging	State	0x4206	Qmax Cell 1	I2	0	32767	4400	mAh
Gas Gauging	State	0x4208	Qmax Cell 2	I2	0	32767	4400	mAh
Gas Gauging	State	0x420A	Qmax Pack	I2	0	32767	4400	mAh
Gas Gauging	State	0x420C	Qmax Cycle Count	U2	0	65535	0	—
Gas Gauging	State	0x420E	Update Status	H1	0x0	0x0E	0x0	—
Gas Gauging	State	0x420F	Cell 1 Chg Voltage at EoC	I2	0	32767	4200	mV
Gas Gauging	State	0x4211	Cell 2 Chg Voltage at EoC	I2	0	32767	4200	mV
Gas Gauging	State	0x4213	Current at EoC	I2	0	32767	250	mA
Gas Gauging	State	0x4215	Avg I Last Run	I2	-32768	32767	-2000	mA
Gas Gauging	State	0x4217	Avg P Last Run	I2	-32768	32767	-3022	cW
Gas Gauging	State	0x4219	Delta Voltage	I2	-32768	32767	0	mV
Gas Gauging	State	0x421B	Temp k	I2	0	32767	100	0.1°C/256 cW
Gas Gauging	State	0x421D	Temp a	I2	0	32767	1000	s
Gas Gauging	State	0x421F	Max Avg I Last Run	I2	-32768	32767	-2000	mA
Gas Gauging	State	0x4221	Max Avg P Last Run	I2	-32768	32767	-3022	cW
Gas Gauging	State	0x4223	SOH Temp k	I2	0	32767	100	0.1°C/256 cW
Gas Gauging	State	0x4225	SOH Temp a	I2	0	32767	1000	s

Table 14-1. Data Flash Table (continued)

Class	Subclass	Address	Name	Type	Min Value	Max Value	Default	Units
Gas Gauging	State	0x4240	Cycle Count	U2	0	65535	0	—
Gas Gauging	IT Cfg	0x4200	Design Resistance	I2	1	32767	96	mΩ
Gas Gauging	IT Cfg	0x4202	Pack Resistance	I2	0	32767	30	mΩ
Gas Gauging	IT Cfg	0x4204	System Resistance	I2	0	32767	0	mΩ
Gas Gauging	IT Cfg	0x458E	Ra Filter	U2	0	999	800	0.1%
Gas Gauging	IT Cfg	0x4591	Ra Max Delta	U1	0	255	15	%
Gas Gauging	IT Cfg	0x4594	Resistance Parameter Filter	U2	1	65535	65142	—
Gas Gauging	IT Cfg	0x4596	Near EDV Ra Param Filter	U2	1	65535	59220	—
Gas Gauging	IT Cfg	0x45BC	Qmax Delta	U1	3	100	5	%
Gas Gauging	IT Cfg	0x45BD	Qmax Upper Bound	U1	100	255	130	%
Gas Gauging	IT Cfg	0x45BE	Term Voltage	I2	0	32767	6000	mV
Gas Gauging	IT Cfg	0x45C0	Term V Hold Time	U1	0	255	1	s
Gas Gauging	IT Cfg	0x45C1	Term Voltage Delta	I2	0	32767	300	mV
Gas Gauging	IT Cfg	0x45C3	Term Min Cell V	I2	0	32767	2800	mV
Gas Gauging	IT Cfg	0x45CC	Max Simulation Iterations	U1	20	50	30	—
Gas Gauging	IT Cfg	0x45DD	Fast Scale Start SOC	U1	0	100	10	%
Gas Gauging	IT Cfg	0x45E6	Min Delta Voltage	I2	-32768	32767	0	mV
Gas Gauging	IT Cfg	0x4651	Load Select	U1	0	7	7	—
Gas Gauging	IT Cfg	0x4652	Load Mode	U1	0	1	0	—
Gas Gauging	IT Cfg	0x4653	User Rate-mA	I2	-9000	0	0	mA
Gas Gauging	IT Cfg	0x4655	User Rate-cW	I2	-32768	0	0	cW
Gas Gauging	IT Cfg	0x4657	Reserve Cap-mAh	I2	0	9000	0	mAh
Gas Gauging	IT Cfg	0x4659	Reserve Cap-cWh	I2	0	32000	0	cWh
Gas Gauging	Smoothing	0x465B	Smooth Relax Time	I2	1	32767	1000	s
Gas Gauging	SoH	0x45E8	SoH Load Rate	U1	0	255	50	0.1 Hr rate
Power	Power	0x460A	Valid Update Voltage	I2	0	32767	2800	mV
Power	Shutdown	0x460C	Shutdown Voltage	I2	0	32767	2300	mV
Power	Shutdown	0x460E	Shutdown Time	U1	0	255	10	s
Power	Shutdown	0x460F	Charger Present Threshold	I2	0	32767	3000	mV
Power	Sleep	0x4611	Sleep Current	I2	0	32767	10	mA
Power	Sleep	0x4613	Bus Timeout	U1	0	255	5	s
Power	Sleep	0x4618	Voltage Time	U1	1	20	5	s
Power	Sleep	0x4619	Current Time	U1	1	60	20	s
Power	Sleep	0x461A	Wake Comparator	H1	0x0	0xFF	0x0	Hex
Power	Ship	0x461B	FET Off Time	U1	0	127	10	s
Power	Ship	0x461C	Delay	U1	0	254	20	s
Power	Ship	0x4622	Auto Ship Time	U2	0	65535	1440	min
PF Status	Device Status Data	0x42C0	Safety Alert A	H1	0x0	0xFF	0x0	Hex
PF Status	Device Status Data	0x42C1	Safety Status A	H1	0x0	0xFF	0x0	Hex
PF Status	Device Status Data	0x42C2	Safety Alert B	H1	0x0	0xFF	0x0	Hex
PF Status	Device Status Data	0x42C3	Safety Status B	H1	0x0	0xFF	0x0	Hex
PF Status	Device Status Data	0x42C4	Safety Alert C	H1	0x0	0xFF	0x0	Hex
PF Status	Device Status Data	0x42C5	Safety Status C	H1	0x0	0xFF	0x0	Hex
PF Status	Device Status Data	0x42C6	Safety Alert D	H1	0x0	0xFF	0x0	Hex
PF Status	Device Status Data	0x42C7	Safety Status D	H1	0x0	0xFF	0x0	Hex

Table 14-1. Data Flash Table (continued)

Class	Subclass	Address	Name	Type	Min Value	Max Value	Default	Units
PF Status	Device Status Data	0x42C8	PF Alert A	H1	0x0	0xFF	0x0	Hex
PF Status	Device Status Data	0x42C9	PF Status A	H1	0x0	0xFF	0x0	Hex
PF Status	Device Status Data	0x42CA	PF Alert B	H1	0x0	0xFF	0x0	Hex
PF Status	Device Status Data	0x42CB	PF Status B	H1	0x0	0xFF	0x0	Hex
PF Status	Device Status Data	0x42CF	PF Status D	H1	0x0	0xFF	0x0	Hex
PF Status	Device Status Data	0x42D0	Operation Status A	H2	0x0	0xFFFF	0x0	Hex
PF Status	Device Status Data	0x42D2	Operation Status B	H2	0x0	0xFFFF	0x0	Hex
PF Status	Device Status Data	0x42D4	Temp Range	H1	0x0	0xFF	0x0	Hex
PF Status	Device Status Data	0x42D5	Charging Status A	H1	0x0	0xFF	0x0	Hex
PF Status	Device Status Data	0x42D6	Charging Status B	H1	0x0	0xFF	0x0	Hex
PF Status	Device Status Data	0x42D7	Gauging Status	H1	0x0	0xFF	0x0	Hex
PF Status	Device Status Data	0x42D8	IT Status	H2	0x0	0xFFFF	0x0	Hex
PF Status	Device Voltage Data	0x42DA	Cell 1 Voltage	I2	-32768	32767	0	mV
PF Status	Device Voltage Data	0x42DC	Cell 2 Voltage	I2	-32768	32767	0	mV
PF Status	Device Voltage Data	0x42DE	Battery Direct Voltage	I2	-32768	32767	0	mV
PF Status	Device Voltage Data	0x42E0	Pack Voltage	I2	-32768	32767	0	mV
PF Status	Device Current Data	0x42E2	Current	I2	-32768	32767	0	mA
PF Status	Device Temperature Data	0x42E4	Internal Temperature	I2	-32768	32767	0	0.1°K
PF Status	Device Temperature Data	0x42E6	External 1 Temperature	I2	-32768	32767	0	0.1°K
PF Status	Device Temperature Data	0x42E8	External 2 Temperature	I2	-32768	32767	0	0.1°K
PF Status	Device Gauging Data	0x42EA	Cell 1 Dod0	I2	-32768	32767	0	—
PF Status	Device Gauging Data	0x42EC	Cell 2 Dod0	I2	-32768	32767	0	—
PF Status	Device Gauging Data	0x42EE	Passed Charge	I2	-32768	32767	0	mAh
PF Status	AFE Regs	0x42F0	AFE Interrupt Status	H1	0x0	0xFF	0x0	Hex
PF Status	AFE Regs	0x42F1	AFE FET Status	H1	0x0	0xFF	0x0	Hex
PF Status	AFE Regs	0x42F2	AFE RXIN	H1	0x0	0xFF	0x0	Hex
PF Status	AFE Regs	0x42F3	AFE Latch Status	H1	0x0	0xFF	0x0	Hex
PF Status	AFE Regs	0x42F4	AFE Interrupt Enable	H1	0x0	0xFF	0x0	Hex
PF Status	AFE Regs	0x42F5	AFE FET Control	H1	0x0	0xFF	0x0	Hex
PF Status	AFE Regs	0x42F6	AFE RXIEN	H1	0x0	0xFF	0x0	Hex
PF Status	AFE Regs	0x42F7	AFE RLOUT	H1	0x0	0xFF	0x0	Hex
PF Status	AFE Regs	0x42F8	AFE RHOUT	H1	0x0	0xFF	0x0	Hex
PF Status	AFE Regs	0x42F9	AFE RHINT	H1	0x0	0xFF	0x0	Hex
PF Status	AFE Regs	0x42FA	AFE Cell Balance	H1	0x0	0xFF	0x0	Hex
PF Status	AFE Regs	0x42FB	AFE AD/CC Control	H1	0x0	0xFF	0x0	Hex
PF Status	AFE Regs	0x42FC	AFE ADC Mux	H1	0x0	0xFF	0x0	Hex

Table 14-1. Data Flash Table (continued)

Class	Subclass	Address	Name	Type	Min Value	Max Value	Default	Units
PF Status	AFE Regs	0x42FD	AFE LED Output	H1	0x0	0xFF	0x0	Hex
PF Status	AFE Regs	0x42FE	AFE State Control	H1	0x0	0xFF	0x0	Hex
PF Status	AFE Regs	0x42FF	AFE LED/Wake Control	H1	0x0	0xFF	0x0	Hex
PF Status	AFE Regs	0x4300	AFE Protection Control	H1	0x0	0xFF	0x0	Hex
PF Status	AFE Regs	0x4301	AFE OCD	H1	0x0	0xFF	0x0	Hex
PF Status	AFE Regs	0x4302	AFE SCC	H1	0x0	0xFF	0x0	Hex
PF Status	AFE Regs	0x4303	AFE SCD1	H1	0x0	0xFF	0x0	Hex
PF Status	AFE Regs	0x4304	AFE SCD2	H1	0x0	0xFF	0x0	Hex
System Data	Manufacturer Data	0x4041	Manufacturer Info Block A01	H1	0x0	0xFF	0x61	Hex
System Data	Manufacturer Data	0x4042	Manufacturer Info Block A02	H1	0x0	0xFF	0x62	Hex
System Data	Manufacturer Data	0x4043	Manufacturer Info Block A03	H1	0x0	0xFF	0x63	Hex
System Data	Manufacturer Data	0x4044	Manufacturer Info Block A04	H1	0x0	0xFF	0x64	Hex
System Data	Manufacturer Data	0x4045	Manufacturer Info Block A05	H1	0x0	0xFF	0x65	Hex
System Data	Manufacturer Data	0x4046	Manufacturer Info Block A06	H1	0x0	0xFF	0x66	Hex
System Data	Manufacturer Data	0x4047	Manufacturer Info Block A07	H1	0x0	0xFF	0x67	Hex
System Data	Manufacturer Data	0x4048	Manufacturer Info Block A08	H1	0x0	0xFF	0x68	Hex
System Data	Manufacturer Data	0x4049	Manufacturer Info Block A09	H1	0x0	0xFF	0x69	Hex
System Data	Manufacturer Data	0x404A	Manufacturer Info Block A10	H1	0x0	0xFF	0x6A	Hex
System Data	Manufacturer Data	0x404B	Manufacturer Info Block A11	H1	0x0	0xFF	0x6B	Hex
System Data	Manufacturer Data	0x404C	Manufacturer Info Block A12	H1	0x0	0xFF	0x6C	Hex
System Data	Manufacturer Data	0x404D	Manufacturer Info Block A13	H1	0x0	0xFF	0x6D	Hex
System Data	Manufacturer Data	0x404E	Manufacturer Info Block A14	H1	0x0	0xFF	0x6E	Hex
System Data	Manufacturer Data	0x404F	Manufacturer Info Block A15	H1	0x0	0xFF	0x6F	Hex
System Data	Manufacturer Data	0x4050	Manufacturer Info Block A16	H1	0x0	0xFF	0x70	Hex
System Data	Manufacturer Data	0x4051	Manufacturer Info Block A17	H1	0x0	0xFF	0x71	Hex
System Data	Manufacturer Data	0x4052	Manufacturer Info Block A18	H1	0x0	0xFF	0x72	Hex
System Data	Manufacturer Data	0x4053	Manufacturer Info Block A19	H1	0x0	0xFF	0x73	Hex
System Data	Manufacturer Data	0x4054	Manufacturer Info Block A20	H1	0x0	0xFF	0x74	Hex
System Data	Manufacturer Data	0x4055	Manufacturer Info Block A21	H1	0x0	0xFF	0x75	Hex
System Data	Manufacturer Data	0x4056	Manufacturer Info Block A22	H1	0x0	0xFF	0x76	Hex
System Data	Manufacturer Data	0x4057	Manufacturer Info Block A23	H1	0x0	0xFF	0x77	Hex
System Data	Manufacturer Data	0x4058	Manufacturer Info Block A24	H1	0x0	0xFF	0x7A	Hex
System Data	Manufacturer Data	0x4059	Manufacturer Info Block A25	H1	0x0	0xFF	0x78	Hex
System Data	Manufacturer Data	0x405A	Manufacturer Info Block A26	H1	0x0	0xFF	0x79	Hex
System Data	Manufacturer Data	0x405B	Manufacturer Info Block A27	H1	0x0	0xFF	0x30	Hex
System Data	Manufacturer Data	0x405C	Manufacturer Info Block A28	H1	0x0	0xFF	0x31	Hex
System Data	Manufacturer Data	0x405D	Manufacturer Info Block A29	H1	0x0	0xFF	0x32	Hex
System Data	Manufacturer Data	0x405E	Manufacturer Info Block A30	H1	0x0	0xFF	0x33	Hex
System Data	Manufacturer Data	0x405F	Manufacturer Info Block A31	H1	0x0	0xFF	0x34	Hex
System Data	Manufacturer Data	0x4060	Manufacturer Info Block A32	H1	0x0	0xFF	0x35	Hex
System Data	Integrity	0x4061	Static DF Signature	H2	0x0	0x7FFF	0x0	Hex
System Data	Integrity	0x4063	Static Chem DF Signature	H2	0x0	0x7FFF	0x6C98	Hex
System Data	Integrity	0x4065	All DF Signature	H2	0x0	0x7FFF	0x0	Hex
I2C Configuration	Data	0x4067	Manufacture Date	U2	0	65535	0	date
I2C Configuration	Data	0x4069	Serial Number	H2	0x0	0xFFFF	0x0001	Hex
I2C Configuration	Data	0x406B	Manufacturer Name	S21	x	x	Texas Instruments	—
I2C Configuration	Data	0x4080	Device Name	S21	x	x	BQ28Z610	—
I2C Configuration	Data	0x4095	Device Chemistry	S5	x	x	LION	—
Lifetimes	Voltage	0x4280	Cell 1 Max Voltage	I2	0	32767	0	mV

Table 14-1. Data Flash Table (continued)

Class	Subclass	Address	Name	Type	Min Value	Max Value	Default	Units
Lifetimes	Voltage	0x4282	Cell 2 Max Voltage	I2	0	32767	0	mV
Lifetimes	Current	0x4284	Max Charge Current	I2	0	32767	0	mA
Lifetimes	Current	0x4286	Max Discharge Current	I2	-32768	0	0	mA
Lifetimes	Temperature	0x4288	Max Temp Cell	I1	-128	127	-128	°C
Lifetimes	Temperature	0x4289	Min Temp Cell	I1	-128	127	127	°C
Ra Table	R_a0	0x4100	Cell0 R_a flag	H2	0x0	0xFFFF	0xFF55	—
Ra Table	R_a0	0x4102	Cell0 R_a 0	I2	0	32767	67	2 ⁻¹⁰ Ω
Ra Table	R_a0	0x4104	Cell0 R_a 1	I2	0	32767	71	2 ⁻¹⁰ Ω
Ra Table	R_a0	0x4106	Cell0 R_a 2	I2	0	32767	83	2 ⁻¹⁰ Ω
Ra Table	R_a0	0x4108	Cell0 R_a 3	I2	0	32767	110	2 ⁻¹⁰ Ω
Ra Table	R_a0	0x410A	Cell0 R_a 4	I2	0	32767	96	2 ⁻¹⁰ Ω
Ra Table	R_a0	0x410C	Cell0 R_a 5	I2	0	32767	77	2 ⁻¹⁰ Ω
Ra Table	R_a0	0x410E	Cell0 R_a 6	I2	0	32767	96	2 ⁻¹⁰ Ω
Ra Table	R_a0	0x4110	Cell0 R_a 7	I2	0	32767	86	2 ⁻¹⁰ Ω
Ra Table	R_a0	0x4112	Cell0 R_a 8	I2	0	32767	84	2 ⁻¹⁰ Ω
Ra Table	R_a0	0x4114	Cell0 R_a 9	I2	0	32767	82	2 ⁻¹⁰ Ω
Ra Table	R_a0	0x4116	Cell0 R_a 10	I2	0	32767	81	2 ⁻¹⁰ Ω
Ra Table	R_a0	0x4118	Cell0 R_a 11	I2	0	32767	92	2 ⁻¹⁰ Ω
Ra Table	R_a0	0x411A	Cell0 R_a 12	I2	0	32767	103	2 ⁻¹⁰ Ω
Ra Table	R_a0	0x411C	Cell0 R_a 13	I2	0	32767	123	2 ⁻¹⁰ Ω
Ra Table	R_a0	0x411E	Cell0 R_a 14	I2	0	32767	658	2 ⁻¹⁰ Ω
Ra Table	R_a1	0x4140	Cell1 R_a flag	H2	0x0	0xFFFF	0xFF55	—
Ra Table	R_a1	0x4142	Cell1 R_a 0	I2	0	32767	67	2 ⁻¹⁰ Ω
Ra Table	R_a1	0x4144	Cell1 R_a 1	I2	0	32767	71	2 ⁻¹⁰ Ω
Ra Table	R_a1	0x4146	Cell1 R_a 2	I2	0	32767	83	2 ⁻¹⁰ Ω
Ra Table	R_a1	0x4148	Cell1 R_a 3	I2	0	32767	110	2 ⁻¹⁰ Ω
Ra Table	R_a1	0x414A	Cell1 R_a 4	I2	0	32767	96	2 ⁻¹⁰ Ω
Ra Table	R_a1	0x414C	Cell1 R_a 5	I2	0	32767	77	2 ⁻¹⁰ Ω
Ra Table	R_a1	0x414E	Cell1 R_a 6	I2	0	32767	96	2 ⁻¹⁰ Ω
Ra Table	R_a1	0x4150	Cell1 R_a 7	I2	0	32767	86	2 ⁻¹⁰ Ω
Ra Table	R_a1	0x4152	Cell1 R_a 8	I2	0	32767	84	2 ⁻¹⁰ Ω
Ra Table	R_a1	0x4154	Cell1 R_a 9	I2	0	32767	82	2 ⁻¹⁰ Ω
Ra Table	R_a1	0x4156	Cell1 R_a 10	I2	0	32767	81	2 ⁻¹⁰ Ω
Ra Table	R_a1	0x4158	Cell1 R_a 11	I2	0	32767	92	2 ⁻¹⁰ Ω
Ra Table	R_a1	0x415A	Cell1 R_a 12	I2	0	32767	103	2 ⁻¹⁰ Ω
Ra Table	R_a1	0x415C	Cell1 R_a 13	I2	0	32767	123	2 ⁻¹⁰ Ω
Ra Table	R_a1	0x415E	Cell1 R_a 14	I2	0	32767	658	2 ⁻¹⁰ Ω
Ra Table	R_a0x	0x4180	xCell0 R_a flag	H2	0x0	0xFFFF	0xFFFF	—
Ra Table	R_a0x	0x4182	xCell0 R_a 0	I2	0	32767	67	2 ⁻¹⁰ Ω
Ra Table	R_a0x	0x4184	xCell0 R_a 1	I2	0	32767	71	2 ⁻¹⁰ Ω
Ra Table	R_a0x	0x4186	xCell0 R_a 2	I2	0	32767	83	2 ⁻¹⁰ Ω
Ra Table	R_a0x	0x4188	xCell0 R_a 3	I2	0	32767	110	2 ⁻¹⁰ Ω
Ra Table	R_a0x	0x418A	xCell0 R_a 4	I2	0	32767	96	2 ⁻¹⁰ Ω
Ra Table	R_a0x	0x418C	xCell0 R_a 5	I2	0	32767	77	2 ⁻¹⁰ Ω
Ra Table	R_a0x	0x418E	xCell0 R_a 6	I2	0	32767	96	2 ⁻¹⁰ Ω
Ra Table	R_a0x	0x4190	xCell0 R_a 7	I2	0	32767	86	2 ⁻¹⁰ Ω
Ra Table	R_a0x	0x4192	xCell0 R_a 8	I2	0	32767	84	2 ⁻¹⁰ Ω
Ra Table	R_a0x	0x4194	xCell0 R_a 9	I2	0	32767	82	2 ⁻¹⁰ Ω

Table 14-1. Data Flash Table (continued)

Class	Subclass	Address	Name	Type	Min Value	Max Value	Default	Units
Ra Table	R_a0x	0x4196	xCell0 R_a 10	I2	0	32767	81	2 ⁻¹⁰ Ω
Ra Table	R_a0x	0x4198	xCell0 R_a 11	I2	0	32767	92	2 ⁻¹⁰ Ω
Ra Table	R_a0x	0x419A	xCell0 R_a 12	I2	0	32767	103	2 ⁻¹⁰ Ω
Ra Table	R_a0x	0x419C	xCell0 R_a 13	I2	0	32767	123	2 ⁻¹⁰ Ω
Ra Table	R_a0x	0x419E	xCell0 R_a 14	I2	0	32767	658	2 ⁻¹⁰ Ω
Ra Table	R_a1x	0x41C0	xCell1 R_a flag	H2	0x0	0xFFFF	0xFFFF	—
Ra Table	R_a1x	0x41C2	xCell1 R_a 0	I2	0	32767	67	2 ⁻¹⁰ Ω
Ra Table	R_a1x	0x41C4	xCell1 R_a 1	I2	0	32767	71	2 ⁻¹⁰ Ω
Ra Table	R_a1x	0x41C6	xCell1 R_a 2	I2	0	32767	83	2 ⁻¹⁰ Ω
Ra Table	R_a1x	0x41C8	xCell1 R_a 3	I2	0	32767	110	2 ⁻¹⁰ Ω
Ra Table	R_a1x	0x41CA	xCell1 R_a 4	I2	0	32767	96	2 ⁻¹⁰ Ω
Ra Table	R_a1x	0x41CC	xCell1 R_a 5	I2	0	32767	77	2 ⁻¹⁰ Ω
Ra Table	R_a1x	0x41CE	xCell1 R_a 6	I2	0	32767	96	2 ⁻¹⁰ Ω
Ra Table	R_a1x	0x41D0	xCell1 R_a 7	I2	0	32767	86	2 ⁻¹⁰ Ω
Ra Table	R_a1x	0x41D2	xCell1 R_a 8	I2	0	32767	84	2 ⁻¹⁰ Ω
Ra Table	R_a1x	0x41D4	xCell1 R_a 9	I2	0	32767	82	2 ⁻¹⁰ Ω
Ra Table	R_a1x	0x41D6	xCell1 R_a 10	I2	0	32767	81	2 ⁻¹⁰ Ω
Ra Table	R_a1x	0x41D8	xCell1 R_a 11	I2	0	32767	92	2 ⁻¹⁰ Ω
Ra Table	R_a1x	0x41DA	xCell1 R_a 12	I2	0	32767	103	2 ⁻¹⁰ Ω
Ra Table	R_a1x	0x41DC	xCell1 R_a 13	I2	0	32767	123	2 ⁻¹⁰ Ω
Ra Table	R_a1x	0x41DE	xCell1 R_a 14	I2	0	32767	658	2 ⁻¹⁰ Ω

AFE Threshold and Delay Settings

A.1 Overload in Discharge Protection (AOLD)

**Table A-1. Overload in Discharge Protection Threshold
(Settings:AFE:AFE Protection Control [RSNS] = 0)⁽¹⁾**

OLD Threshold ([RSNS] = 0)			
Setting	Threshold	Setting	Threshold
0x00	–8.30 mV	0x08	–30.54 mV
0x01	–11.08 mV	0x09	–33.32 mV
0x02	–13.86 mV	0x0A	–36.10 mV
0x03	–16.64 mV	0x0B	–38.88 mV
0x04	–19.42 mV	0x0C	–41.66 mV
0x05	–22.20 mV	0x0D	–44.44 mV
0x06	–24.98 mV	0x0E	–47.22 mV
0x07	–27.76 mV	0x0F	–50.00 mV

⁽¹⁾ The data flash setting *Protection:AFE Thresholds:OLD Threshold[3:0]* sets the voltage threshold.

**Table A-2. Overload in Discharge Protection Threshold
(Settings:AFE:AFE Protection Control [RSNS] = 1)⁽¹⁾**

OLD Threshold ([RSNS] = 1)			
Setting	Threshold	Setting	Threshold
0x00	–16.60 mV	0x08	–61.08 mV
0x01	–22.16 mV	0x09	–66.64 mV
0x02	–27.72 mV	0x0A	–72.20 mV
0x03	–33.28 mV	0x0B	–77.76 mV
0x04	–38.84 mV	0x0C	–83.32 mV
0x05	–44.40 mV	0x0D	–88.88 mV
0x06	–49.96 mV	0x0E	–94.44 mV
0x07	–55.52 mV	0x0F	–100.00 mV

⁽¹⁾ The data flash setting *Protection:AFE Thresholds:OLD Threshold[3:0]* sets the voltage threshold.

Table A-3. Overload in Discharge Protection Delay⁽¹⁾

Setting	Time	Setting	Time	Setting	Time	Setting	Time
0x00	1 ms	0x04	9 ms	0x08	17 ms	0x0C	25 ms
0x01	3 ms	0x05	11 ms	0x09	19 ms	0x0D	27 ms
0x02	5 ms	0x06	13 ms	0x0A	21 ms	0x0E	29 ms
0x03	7 ms	0x07	15 ms	0x0B	23 ms	0x0F	31 ms

⁽¹⁾ The data flash setting *Protection:AFE Thresholds:OLD Threshold[7:4]* sets the delay time.

A.2 Short Circuit in Charge (ASCC)

**Table A-4. Short Circuit in Charge Threshold
(Settings:AFE:AFE Protection Control [RSNS] = 0)⁽¹⁾**

Setting	Threshold	Setting	Threshold
0x00	22.2 mV	0x04	66.65 mV
0x01	33.3 mV	0x05	77.75 mV
0x02	44.4 mV	0x06	88.85 mV
0x03	55.5 mV	0x07	100 mV

⁽¹⁾ The data flash setting *Protection:AFE Thresholds:SCC Threshold[2:0]* sets the voltage threshold.

**Table A-5. Short Circuit in Charge Threshold
(Settings:AFE:AFE Protection Control [RSNS] = 1)⁽¹⁾**

Setting	Threshold	Setting	Threshold
0x00	44.4 mV	0x04	133.3 mV
0x01	66.6 mV	0x05	155.5 mV
0x02	88.8 mV	0x06	177.7 mV
0x03	111.1 mV	0x07	200 mV

⁽¹⁾ The data flash setting *Protection:AFE Thresholds:SCC Threshold[2:0]* sets the voltage threshold.

Table A-6. Short Circuit in Charge Delay⁽¹⁾

Setting	Time	Setting	Time	Setting	Time	Setting	Time
0x00	0 μ s	0x04	244 μ s	0x08	488 μ s	0x0C	732 μ s
0x01	61 μ s	0x05	305 μ s	0x09	549 μ s	0x0D	793 μ s
0x02	122 μ s	0x06	366 μ s	0x0A	610 μ s	0x0E	854 μ s
0x03	183 μ s	0x07	427 μ s	0x0B	671 μ s	0x0F	915 μ s

⁽¹⁾ The data flash setting *Protection:AFE Thresholds:SCC Threshold[7:4]* sets the delay time.

A.3 Short Circuit in Discharge (ASCD1 and ASCD2)

**Table A-7. Short Circuit in Discharge Threshold
(Settings:AFE:AFE Protection Control [RSNS] = 0)⁽¹⁾**

Setting	Threshold	Setting	Threshold
0x00	-22.2 mV	0x04	-66.65 mV
0x01	-33.3 mV	0x05	-77.75 mV
0x02	-44.4 mV	0x06	-88.85 mV
0x03	-55.5 mV	0x07	-100 mV

⁽¹⁾ The data flash setting *Protection:AFE Thresholds:SCD1 Threshold[2:0]* and *Protection:AFE Thresholds:SCD2 Threshold[2:0]* sets the voltage thresholds.

**Table A-8. Short Circuit in Discharge Threshold
(Settings:AFE:AFE Protection Control [RSNS] = 1)⁽¹⁾**

Setting	Threshold	Setting	Threshold
0x00	-44.4 mV	0x04	-133.3 mV
0x01	-66.6 mV	0x05	-155.5 mV
0x02	-88.8 mV	0x06	-177.7 mV
0x03	-111.1 mV	0x07	-200 mV

⁽¹⁾ The data flash setting *Protection:AFE Thresholds:SCD1 Threshold[2:0]* and *Protection:AFE Thresholds:SCD2 Threshold[2:0]* sets the voltage thresholds.

**Table A-9. Short Circuit in Discharge 1 Delay
(Settings:AFE:AFE Protection Control [SCDDx2] = 0)⁽¹⁾**

Setting	Time	Setting	Time	Setting	Time	Setting	Time
0x00	0 μs	0x04	244 μs	0x08	488 μs	0x0C	732 μs
0x01	61 μs	0x05	305 μs	0x09	549 μs	0x0D	793 μs
0x02	122 μs	0x06	366 μs	0x0A	610 μs	0x0E	854 μs
0x03	183 μs	0x07	427 μs	0x0B	671 μs	0x0F	915 μs

⁽¹⁾ The data flash setting *Protection:AFE Thresholds:SCD1Threshold[7:4]* sets the delay time.

**Table A-10. Short Circuit in Discharge 1 Delay
(Settings:AFE:AFE Protection Control [SCDDx2] = 1)⁽¹⁾**

Setting	Time	Setting	Time	Setting	Time	Setting	Time
0x00	0 μs	0x04	488 μs	0x08	976 μs	0x0C	1464 μs
0x01	122 μs	0x05	610 μs	0x09	1098 μs	0x0D	1586 μs
0x02	244 μs	0x06	732 μs	0x0A	1220 μs	0x0E	1708 μs
0x03	366 μs	0x07	854 μs	0x0B	1342 μs	0x0F	1830 μs

⁽¹⁾ The data flash setting *Protection:AFE Thresholds:SCD1 Threshold[7:4]* sets the delay time.

**Table A-11. Short Circuit in Discharge 2 Delay
(Settings:AFE:AFE Protection Control [SCDDx2] = 0)⁽¹⁾**

Setting	Time	Setting	Time	Setting	Time	Setting	Time
0x00	0 μs	0x04	122 μs	0x08	244 μs	0x0C	366 μs
0x01	31 μs	0x05	153 μs	0x09	275 μs	0x0D	396 μs
0x02	61 μs	0x06	183 μs	0x0A	305 μs	0x0E	427 μs
0x03	92 μs	0x07	214 μs	0x0B	335 μs	0x0F	458 μs

⁽¹⁾ The data flash setting *Protection:AFE Thresholds:SCD2 Threshold[7:4]* sets the delay time.

**Table A-12. Short Circuit in Discharge 2 Delay
(Settings:AFE:AFE Protection Control [SCDDx2] = 1)⁽¹⁾**

Setting	Time	Setting	Time	Setting	Time	Setting	Time
0x00	0 μs	0x04	244 μs	0x08	488 μs	0x0C	732 μs
0x01	62 μs	0x05	306 μs	0x09	550 μs	0x0D	792 μs
0x02	122 μs	0x06	366 μs	0x0A	610 μs	0x0E	854 μs
0x03	184 μs	0x07	428 μs	0x0B	670 μs	0x0F	916 μs

⁽¹⁾ The data flash setting *Protection:AFE Thresholds:SCD2 Threshold[7:4]* sets the delay time.

Revision History

NOTE: Page numbers for previous revisions may differ from page numbers in the current version.

Changes from C Revision (October 2018) to D Revision	Page
• Changed Temperature Protections	13
• Added VIMR/VIMA in Permanent Fail	17
• Changed Impedance Track Configuration	30
• Changed QMax and Ra	32
• Changed Section 6.4.3	33
• Changed Impedance Track (IT) Configuration Options	37
• Changed State-of-Health (SOH)	37
• Changed the Cell Balancing Time Formula in Cell Balancing Setup	42
• Changed Lifetime Data Collection	46
• Added 0x0E/0F MaxError()	60
• Changed AltManufacturerAccess() 0x0053 PFStatus	74
• Changed Configuration	90
• Changed Permanent Failure	93
• Changed Manufacturing	94
• Added thermal model temperature factor for SOH in State	100
• Changed PTO—PRECHARGE Mode Time Out	106
• Changed CTO—FAST CHARGE Mode Time Out	106
• Changed Data Flash Table	115

Changes from B Revision (May 2016) to C Revision	Page
• Changed Maintenance Charge	24
• Added BROADCAST Mode	24
• Changed NORMAL Mode	26
• Added Emergency FET Shutdown	28
• Changed Impedance Track Configuration	29
• Changed Impedance Track (IT) Configuration Options	37
• Changed the Cell Balancing Time Formula in Cell Balancing Setup	42
• Changed Section 9.4	48
• Changed Standard Data Commands	57
• Changed Standard Commands	58
• Added 0x24/25 BTPDischargeSet()	62
• Added 0x26/27 BTPChargeSet()	62
• Changed Section 12.1.24	63
• Changed 0x0010 SHUTDOWN Mode	68
• Changed 0x0011 SLEEP Mode	68
• Changed 0x0054 OperationStatus	75
• Changed 0x0073 ITStatus1	82
• Changed 0x0074 ITStatus2	83
• Changed Section 12.2.40	83
• Changed 0x0075 ITStatus3	83
• Changed 0x0076 CB Status	84
• Changed Charger	92
• Changed Section 13.6.11	102

Changes from A Revision (December 2015) to B Revision
Page

• Changed QMax and Ra	32
• Changed Standard Data Commands	57
• Changed Section 12.1.1	58
• Changed 0x0054 OperationStatus	75
• Changed Section 12.2.32	78
• Changed Section 12.2.33	80
• Added Section 13.2.4	89
• Changed Section 13.3.1	92
• Changed Section 13.3.3	93
• Changed Section 13.3.3	93
• Changed Section 13.12.1	107

IMPORTANT NOTICE AND DISCLAIMER

TI PROVIDES TECHNICAL AND RELIABILITY DATA (INCLUDING DATASHEETS), DESIGN RESOURCES (INCLUDING REFERENCE DESIGNS), APPLICATION OR OTHER DESIGN ADVICE, WEB TOOLS, SAFETY INFORMATION, AND OTHER RESOURCES "AS IS" AND WITH ALL FAULTS, AND DISCLAIMS ALL WARRANTIES, EXPRESS AND IMPLIED, INCLUDING WITHOUT LIMITATION ANY IMPLIED WARRANTIES OF MERCHANTABILITY, FITNESS FOR A PARTICULAR PURPOSE OR NON-INFRINGEMENT OF THIRD PARTY INTELLECTUAL PROPERTY RIGHTS.

These resources are intended for skilled developers designing with TI products. You are solely responsible for (1) selecting the appropriate TI products for your application, (2) designing, validating and testing your application, and (3) ensuring your application meets applicable standards, and any other safety, security, or other requirements. These resources are subject to change without notice. TI grants you permission to use these resources only for development of an application that uses the TI products described in the resource. Other reproduction and display of these resources is prohibited. No license is granted to any other TI intellectual property right or to any third party intellectual property right. TI disclaims responsibility for, and you will fully indemnify TI and its representatives against, any claims, damages, costs, losses, and liabilities arising out of your use of these resources.

TI's products are provided subject to TI's Terms of Sale (www.ti.com/legal/termsofsale.html) or other applicable terms available either on ti.com or provided in conjunction with such TI products. TI's provision of these resources does not expand or otherwise alter TI's applicable warranties or warranty disclaimers for TI products.

Mailing Address: Texas Instruments, Post Office Box 655303, Dallas, Texas 75265
Copyright © 2020, Texas Instruments Incorporated