

REVISIONS

P	LTR	DESCRIPTION	DATE	DWN	APVD
	B	INITIAL RELEASE	12FEB2020	SR	LI

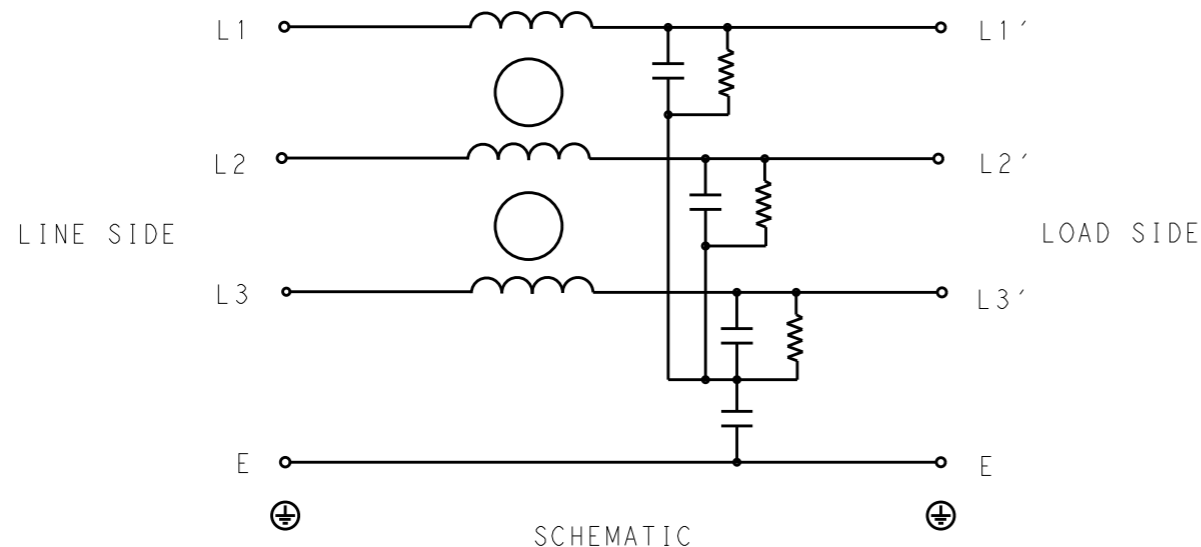

TYPICAL INSERTION LOSS  
COMMON MODE 50/50Ω; DIFFERENTIAL MODE 50/50Ω

MHz	0.01	0.05	0.15	0.5	1	3	5	10	30
CM	2	2	5	12	18	25	32	40	45
DM	3	3	9	14	19	31	35	42	42

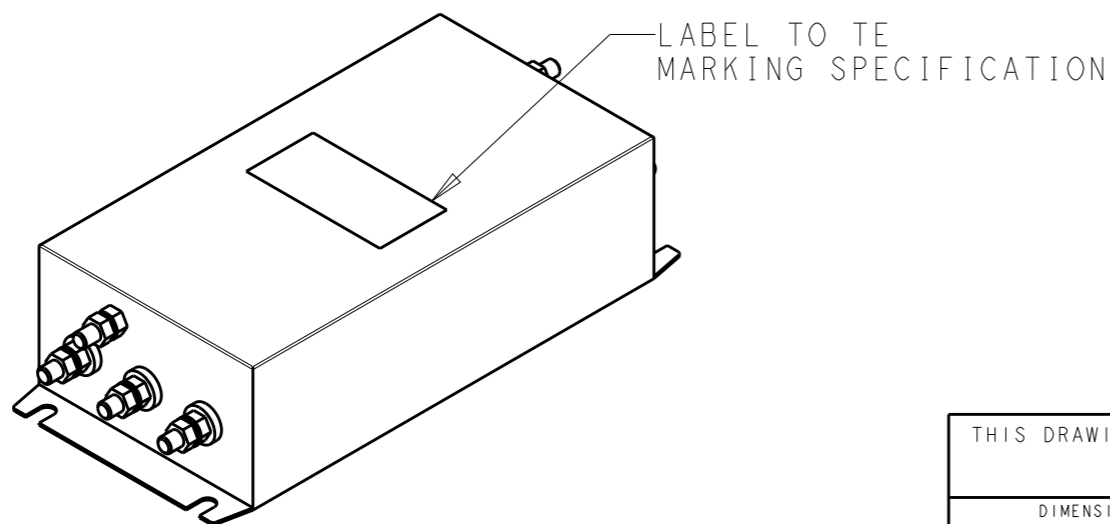

SAFETY ORGANIZATIONS

THIS FILTER WILL BE FORMALLY RECOGNIZED, CERTIFIED OR APPROVED BY THE LISTED AGENCY. THEREFORE, ALL TEST/REQUIREMENTS SPECIFIED IN THE LATEST REVISION OF THE FOLLOWING AGENCY STANDARDS WILL BE MET:

UL RECOGNIZED\* 125A 440V 50Hz/60Hz 40°C  
 CSA CERTIFIED\*\* 125A 440V 50Hz/60Hz 40°C

\*31 JULY 2020 ; \*\*31 AUGUST 2020

OPERATING SPECIFICATION

LINE CURRENT/VOLTAGE: 125A, 440VAC  
LINE FREQUENCY: 50/60Hz

MAXIMUM LEAKAGE CURRENT: 8mA @ 230VAC, 50Hz

OPERATING AMBIENT TEMPERATURE RANGE @ RATED CURRENT: -25°C TO +40°C

IN AN AMBIENT, T<sub>a</sub>, HIGHER THAN 40°C, THE MAXIMUM OPERATING CURRENT, I<sub>o</sub>, IS AS FOLLOWS:

$$I_o = I_r \sqrt{\frac{85 - T_a}{45}}$$

RELIABILITY SPECIFICATIONS

STORAGE TEMPERATURE: -40°C TO +85°C  
HUMIDITY: 21 DAYS @ 40°C AND 95% RH

TEST SPECIFICATIONS

INDUCTANCE, NOMINAL: 0.1mH

CAPACITANCE @ 1kHz  
LINE TO GROUND, NOMINAL: 98nF  
LINE TO LINE, NOMINAL: 3.4μF

DISCHARGE RESISTOR

L/G I.R. 680KΩ 2W  
L/L I.R. 2MΩ 2W  
L/N I.R. XXX  
N/G I.R. XXX

IR (NO DISCHARGE RESISTOR) 20°C, 50% RH AND 100VDC, MIN: 6MΩ

RECOMMENDED RECEIVING INSPECITON HIPOI

LINE TO GROUND FOR 1 MINUTE: 2632VDC  
LINE TO LINE FOR 1 MINUTE: 1892VDC

FILTER APPROVAL

THE BEST WAY TO SELECT AND QUALIFY A FILTER IS FOR YOUR ENGINEERING TO TEST THE UNIT IN YOUR EQUIPMENT.

THIS DRAWING IS A CONTROLLED DOCUMENT.		DWN 06FEB2020 SUPREETH R	 TE Connectivity	
DIMENSIONS: mm		CHK 06FEB2020 LEO IRUDHAYARAJ		
TOLERANCES UNLESS OTHERWISE SPECIFIED:		APVD 06FEB2020 LEO IRUDHAYARAJ	PRODUCT SPEC	RESTRICTED TO
0 PLC ±- 1 PLC ±0.5 2 PLC ±0.40 3 PLC ±0.130 4 PLC ±0.0500 ANGLES ±-		APPLICATION SPEC	SIZE	SCALE
MATERIAL	FINISH	WEIGHT	A300779	1:4
		CUSTOMER DRAWING	CAGE CODE	SHEET
			G=2-1609965-4	1 OF 2
				REV B

© 2020 TE Connectivity. All Rights Reserved.

NOTE 1 GROUND CONNECTION:  
DO NOT LOOSEN INNER GROUND NUTS.  
TORQUE OUTER TERMINAL /GROUND NUTS: 4-10Nm

NOTE 2 INPUT OUTPUT CONNECTION TERMINAL  
AWG SIZE: XXX  
THREADED BOLT SIZE FOR TERMINAL: M10  
THREADED BOLT SIZE FOR GROUND: M10

REVISIONS					
P	LTR	DESCRIPTION	DATE	DWN	APVD
		SEE SHEET 1			

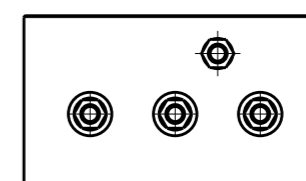
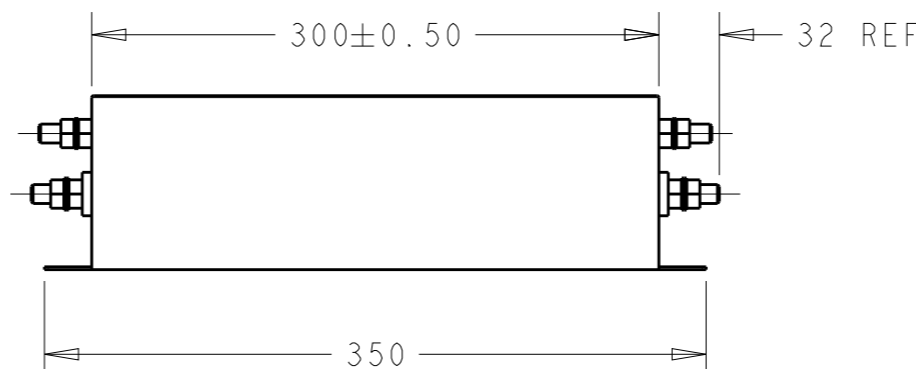
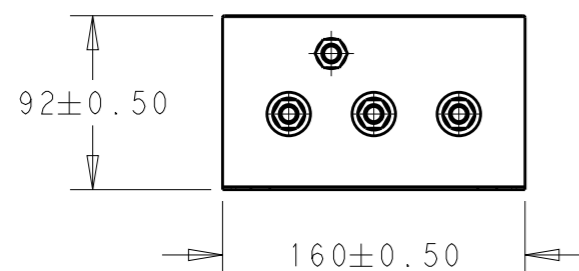
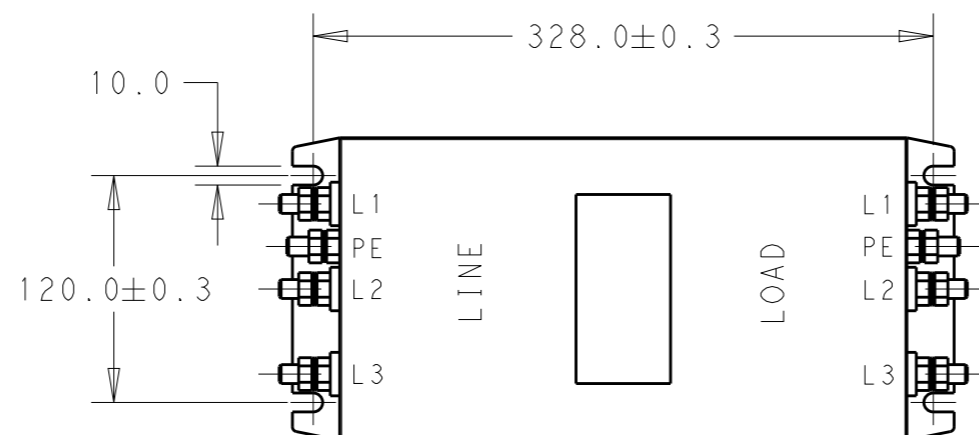

THIS DRAWING IS A CONTROLLED DOCUMENT.		DWN 06FEB2020 SUPREETH R														
DIMENSIONS: mm		CHK 06FEB2020 LEO IRUDHAYARAJ														
TOLERANCES UNLESS OTHERWISE SPECIFIED:		APVD 06FEB2020 LEO IRUDHAYARAJ	NAME POWER LINE FILTER 125KEBS6AFPD													
<table border="1"> <tr><td>0 PLC</td><td>±-</td></tr> <tr><td>1 PLC</td><td>±0.5</td></tr> <tr><td>2 PLC</td><td>±0.40</td></tr> <tr><td>3 PLC</td><td>±0.130</td></tr> <tr><td>4 PLC</td><td>±0.0500</td></tr> <tr><td>ANGLES</td><td>±-</td></tr> </table>		0 PLC	±-	1 PLC	±0.5	2 PLC	±0.40	3 PLC	±0.130	4 PLC	±0.0500	ANGLES	±-	PRODUCT SPEC -	RESTRICTED TO -	
0 PLC	±-															
1 PLC	±0.5															
2 PLC	±0.40															
3 PLC	±0.130															
4 PLC	±0.0500															
ANGLES	±-															
MATERIAL -		APPLICATION SPEC -	SIZE A3	CAGE CODE 00779	DRAWING NO C-2-1609965-4											
FINISH -		WEIGHT -	SCALE 1:4		SHEET 2 OF 2											
		CUSTOMER DRAWING	REV B													