

TD2257

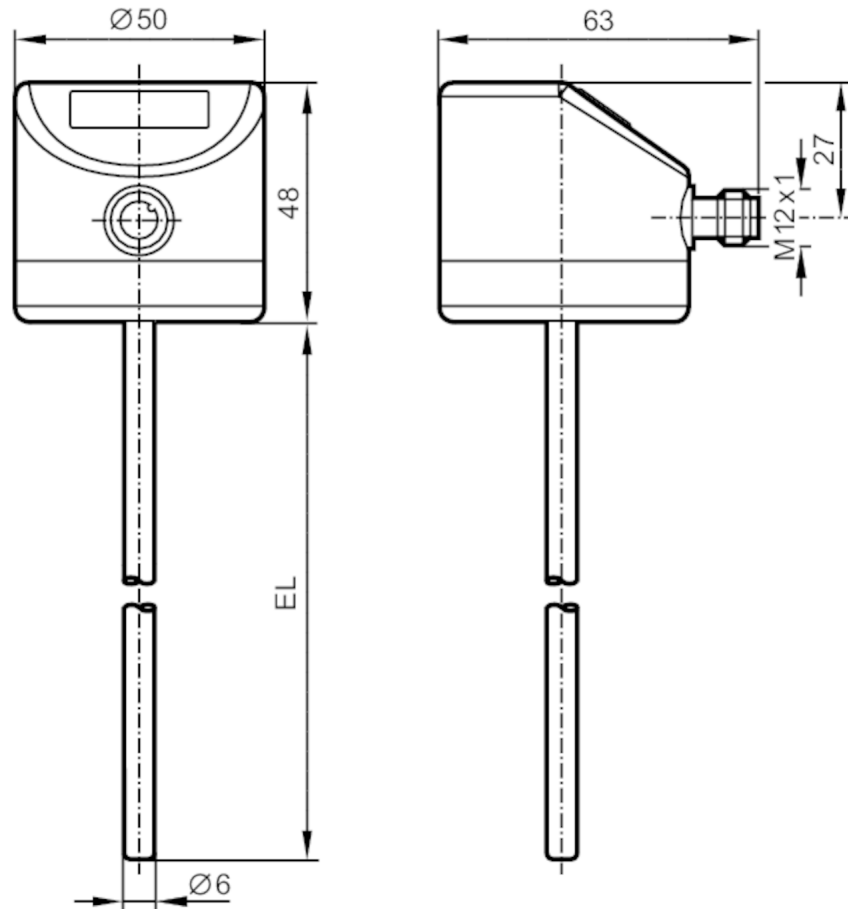

Temperature transmitter with display

TD-200CFED06-A-ZVG/US



EL = installation length



Product characteristics

Number of inputs and outputs	Number of analogue outputs: 1	
Measuring range	-50...150 °C	-58...302 °F
Process connection	diameter Ø 6 mm	
Installation length EL [mm]	200	

Application

Measuring element	1 x Pt 1000; (to DIN EN 60751, class A)	
Media	liquids and gases	
Pressure rating [bar]	160	
Vacuum resistance [mbar]	-1000	

Electrical data

Operating voltage [V]	18...32 DC; ("supply class 2" to cULus)	
Current consumption [mA]	< 50	
Protection class	III	
Reverse polarity protection	yes	
Power-on delay time [s]	2	



Temperature transmitter with display

TD-200CFED06-A-ZVG/US

Inputs / outputs		
Number of inputs and outputs	Number of analogue outputs: 1	
Outputs		
Total number of outputs	1	
Output signal	analogue signal; IO-Link; (configurable)	
Number of analogue outputs	1	
Analogue current output [mA]	4...20	
Max. load [Ω]	300	
Short-circuit protection	yes	
Overload protection	yes	
Measuring/setting range		
Measuring range	-50...150 °C	-58...302 °F
Factory setting	0...100 °C	
Resolution		
Resolution of analogue output [K]	0.04	
Resolution of display [K]	0.1	
Accuracy / deviations		
Precision analogue output [K]	$\pm 0,3 + (\pm 0,1 \% \text{ MS})$	
Temperature coefficient [% of the span / 10 K]	0,1; (in case of deviation from the reference condition 25 °C)	
Response times		
Dynamic response T05 / T09 [s]	1 / 3	
Interfaces		
Communication interface	IO-Link	
Transmission type	COM2 (38,4 kBaud)	
IO-Link revision	1.1	
Operating conditions		
Ambient temperature [°C]	-25...80	
Storage temperature [°C]	-40...100	
Protection	IP 67; IP 68; IP 69K	
Tests / approvals		
EMC	DIN EN 61000-6-2	
	DIN EN 61000-6-3	
Shock resistance	DIN IEC 68-2-27	50 g (11 ms)
Vibration resistance	DIN IEC 68-2-6	10 g (10...2000 Hz)
MTTF [years]	407	
Note on approval	factory certificate available as download at www.factory-certificate.ifm	
UL approval	UL Approval no.	K001
Mechanical data		
Weight [g]	251.5	
Dimensions [mm]	Ø 6	
Materials	stainless steel (1.4404 / 316L); PEI; FKM	
Materials (wetted parts)	stainless steel (1.4404 / 316L) electropolished	

TD2257



Temperature transmitter with display

TD-200CFED06-A-ZVG/US

Process connection	diameter Ø 6 mm
Surface characteristics Ra/Rz of the wetted parts	Ra: < 0.8
Probe diameter [mm]	6
Installation length EL [mm]	200

Displays / operating elements

Display	7-segment LED display, 4-digit display unit / status, °C / °F
---------	--

Remarks

Remarks	MS = set measuring span The values for accuracy apply to flowing water.
Pack quantity	1 pcs.

Electrical connection

Connector: 1 x M12; coding: A



Connection

