

Click [here](#) for production status of specific part numbers.

MAXM15462/MAXM15463/ MAXM15464

General Description

The Himalaya series of voltage regulator ICs and power modules enable cooler, smaller, and simpler power-supply solutions. The MAXM15462/MAXM15463/MAXM15464 are a family of high-efficiency, synchronous step-down DC-DC modules with integrated controller, MOSFETs, compensation components, and inductor that operate over a wide input-voltage range. The modules operate from 4.5V to 42V input and deliver up to 300mA output current. The MAXM15463 and MAXM15464 are fixed 3.3V and 5V output modules respectively. The MAXM15462 is an adjustable output (0.9V to 5V) module. The modules significantly reduce design complexity, manufacturing risks, and offer a true plug and play power/supply solution, reducing time-to-market.

The MAXM15462/3/4 modules employ peak-current-mode control architecture. To reduce input inrush current, the modules offer a fixed 4.1ms soft-start time.

The MAXM15462/3/4 modules are available in a low profile, compact 10-pin, 2.6mm × 3mm × 1.5mm, uSLIC™ package.

Applications

- Industrial Sensors and Encoders
- 4-20mA Current-Loop Powered Sensors
- LDO Replacement
- HVAC and Building Control
- Battery-Powered Equipment

Typical Application Circuit 2.5V

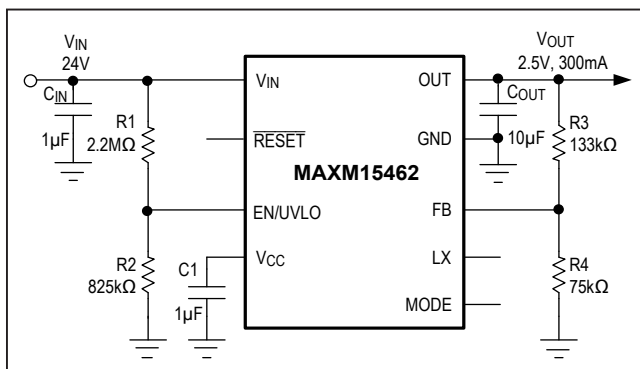

4.5V to 42V, 300mA Himalaya uSLIC Step-Down Power Module

Benefits and Features

- Easy to Use
 - Wide 4.5V to 42V Input
 - Adjustable 0.9V to 5V Output
 - Fixed 3.3V and 5V Output (MAXM15463 and MAXM15464)
 - ±1.5% Feedback Accuracy
 - Up to 300mA Output-Current
 - Internally Compensated
 - All Ceramic Capacitors
- High Efficiency
 - Selectable PWM- or PFM-Mode of Operation
 - Shutdown Current as Low as 2.2μA (typ)
- Flexible Design
 - Internal Soft-Start and Prebias Startup
 - Open-Drain Power Good Output (RESET Pin)
 - Programmable EN/UVLO Threshold
- Robust Operation
 - Hiccup Overcurrent Protection
 - Overtemperature Protection
 - -40°C to +125°C Ambient Operating Temperature/
-40°C to +150°C Junction Temperature
- Rugged
 - Complies with CISPR22(EN55022) Class B Conducted and Radiated Emissions
 - Passes Drop, Shock, and Vibration Standards: JESD22-B103, B104, B111

Ordering Information appears at end of data sheet.

uSLIC is a trademark of Maxim Integrated Products, Inc.

Typical Application Circuit 5V

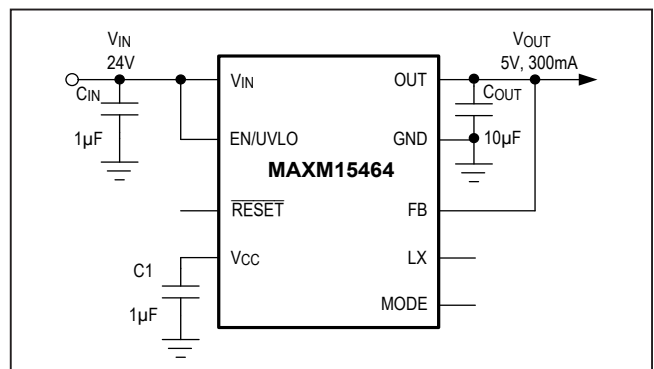

MAXM15462/MAXM15463/
MAXM15464

4.5V to 42V, 300mA Himalaya uSLIC
Step-Down Power Module

Absolute Maximum Ratings

V_{IN} , EN/UVLO to GND	-0.3V to 48V	Junction Temperature (Note 1).....	+150°C
LX, OUT and GND	-0.3V to ($V_{IN} + 0.3V$)	Storage Temperature Range.....	-55°C to +125°C
V_{CC} , FB, RESET to GND.....	-0.3V to 6V	Lead temperature (soldering, 10s).....	+260°C
MODE to GND.....	-0.3V to ($V_{CC} + 0.3V$)	Soldering Temperature (reflow).....	+260°C
Output Short-Circuit Duration.....	Continuous		

Stresses beyond those listed under "Absolute Maximum Ratings" may cause permanent damage to the device. These are stress ratings only, and functional operation of the device at these or any other conditions beyond those indicated in the operational sections of the specifications is not implied. Exposure to absolute maximum rating conditions for extended periods may affect device reliability.

Package Information

PACKAGE TYPE: 10-PIN uSLIC	
Package Code	M102A3+2
Outline Number	21-100094
Land Pattern Number	90-100027
THERMAL RESISTANCE, FOUR-LAYER BOARD (Note 2)	
Junction to Ambient (θ_{JA})	41.56 °C/W

For the latest package outline information and land patterns (footprints), go to www.maximintegrated.com/packages. Note that a "+", "#", or "-" in the package code indicates RoHS status only. Package drawings may show a different suffix character, but the drawing pertains to the package regardless of RoHS status.

- Note 1:** Junction temperature greater than +125°C degrades operating lifetimes.
- Note 2:** Package thermal resistance is measured on an evaluation board with natural convection.

Electrical Characteristics

($V_{IN} = V_{EN/UVLO} = 24V$, $V_{GND} = 0V$, $C_{VCC} = 1\mu F$, FB = 1V (MAXM15462), FB = 3.6V (MAXM15463) FB = 5.5V (MAXM15464), LX = MODE = RESET = OUT = unconnected; $T_A = -40^\circ C$ to $+125^\circ C$, unless otherwise noted. Typical values are at $T_A = +25^\circ C$. All voltages are referenced to GND, unless otherwise noted.) (Note 3)

PARAMETER	SYMBOL	CONDITIONS	MIN	TYP	MAX	UNITS
INPUT SUPPLY (V_{IN})						
Input-Voltage Range	V_{IN}		4.5		42	V
Input-Shutdown Current	I_{IN-SH}	$V_{EN/UVLO} = 0V$, shutdown mode		2.2	4	μA
Input-Supply Current	I_{Q-PFM}	MODE = unconnected, FB = $1.03 \times V_{FB-REG}$		95	160	μA
	I_{Q-PWM}	Normal switching mode, $V_{IN} = 24V$, MODE=0		3.2		mA
ENABLE/UVLO (EN/UVLO)						
EN/UVLO Threshold	V_{ENR}	$V_{EN/UVLO}$ rising	1.19	1.215	1.28	V
	V_{ENF}	$V_{EN/UVLO}$ falling	1.06	1.09	1.16	
	$V_{EN-TRUESD}$	$V_{EN/UVLO}$ falling, true shutdown		0.75		
EN/UVLO Input-Leakage Current	$I_{EN/UVLO}$	$T_A = +25^\circ C$	-100		+100	nA
LDO (V_{CC})						
V_{CC} Output-Voltage Range	V_{CC}	$6V < V_{IN} < 42V$, $0mA < I_{VCC} < 10mA$	4.75	5	5.25	V
V_{CC} Current Limit	$I_{VCC-MAX}$	$V_{CC} = 4.3V$	13	30	50	mA

Electrical Characteristics (continued)

($V_{IN} = V_{EN/UVLO} = 24V$, $V_{GND} = 0V$, $C_{VCC} = 1\mu F$, $FB = 1V$ (MAXM15462), $FB = 3.6V$ (MAXM15463) $FB = 5.5V$ (MAXM15464), $LX = MODE = RESET = OUT =$ unconnected; $T_A = -40^\circ C$ to $+125^\circ C$, unless otherwise noted. Typical values are at $T_A = +25^\circ C$. All voltages are referenced to GND, unless otherwise noted.) (Note 3)

PARAMETER	SYMBOL	CONDITIONS	MIN	TYP	MAX	UNITS
V _{CC} Dropout	V _{CC-DO}	V _{IN} = 4.5V, I _{VCC} = 5mA		0.15	0.3	V
V _{CC} UVLO	V _{CC-UVR}	V _{CC} rising	4.05	4.18	4.3	V
	V _{CC-UVF}	V _{CC} falling	3.7	3.8	3.95	
SOFT-START (SS)						
Soft-Start Time	t _{SS}		3.8	4.1	4.4	ms
FEEDBACK (FB)						
FB-Regulation Voltage	V _{FB-REG}	MODE = GND, MAXM15462	0.887	0.90	0.913	V
		MODE = unconnected, MAXM15462	0.887	0.915	0.936	
		MODE = GND, MAXM15463	3.25	3.30	3.35	
		MODE = unconnected, MAXM15463	3.25	3.35	3.42	
		MODE = GND, MAXM15464	4.93	5.00	5.07	
		MODE = unconnected, MAXM15464	4.93	5.08	5.18	
FB-Leakage Current	I _{FB}	MAXM15462	-100	-25		nA
TIMING						
Switching Frequency	f _{SW}		465	500	535	kHz
FB Undervoltage Trip Level to Cause Hiccup			62.5	64.5	66.5	%
Hiccup Timeout				131		ms
Minimum On-Time	t _{ON-MIN}			90	130	ns
Maximum Duty Cycle	D _{MAX}	FB = 0.98 × FB _{REG}	89	91.4	94	%
RESET						
FB Threshold for RESET Rising		FB rising	93.5	95.5	97.5	%
FB Threshold for RESET Falling		FB falling	90	92	94	%
RESET Delay After FB Reaches Rising Threshold				2		ms
RESET Output-Level Low		I _{RESET} = 5mA			0.2	V
RESET Output-Leakage Current		V _{RESET} = 5.5V, T _A = +25°C			0.1	μA
MODE						
MODE Internal Pullup Resistor				500		kΩ
THERMAL SHUTDOWN						
Thermal-Shutdown Threshold		Temperature rising		166		°C
Thermal-Shutdown Hysteresis				10		°C

Note 3: Electrical specifications are production tested at T_A = +25°C. Specifications over the entire operating temperature range are guaranteed by design and characterization.

Typical Operating Characteristics

($V_{IN} = V_{EN/UVLO} = 24V$, $V_{GND} = 0V$, $T_A = -40^{\circ}C$ to $+125^{\circ}C$, unless otherwise noted. Typical values are at $T_A = +25^{\circ}C$. All voltages are referenced to GND, unless otherwise noted. The circuit values for different output-voltage applications are as in [Table 1](#), unless otherwise noted.)

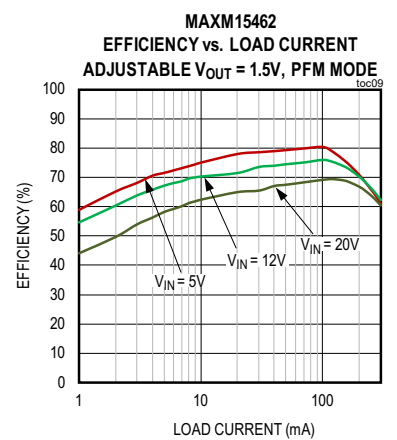
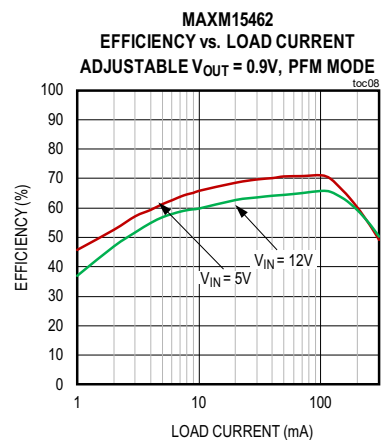
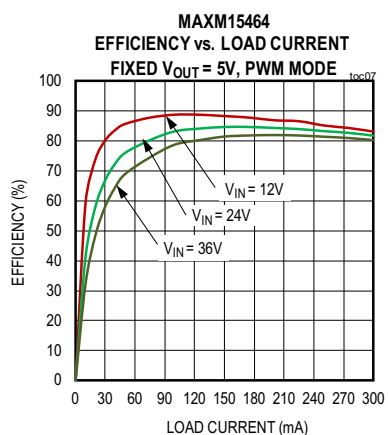
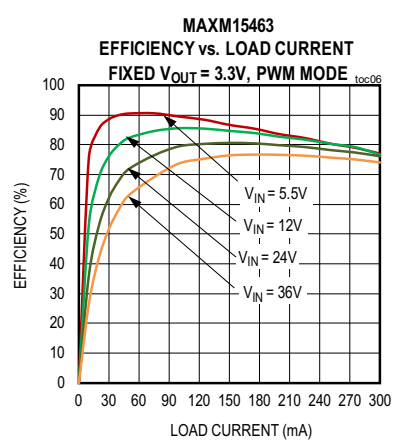
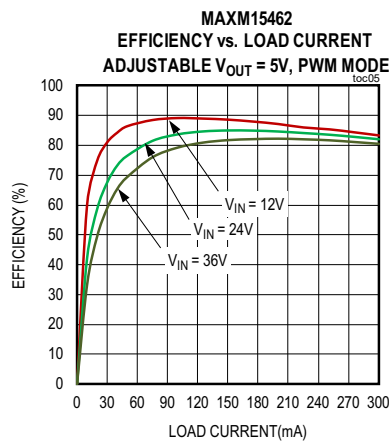
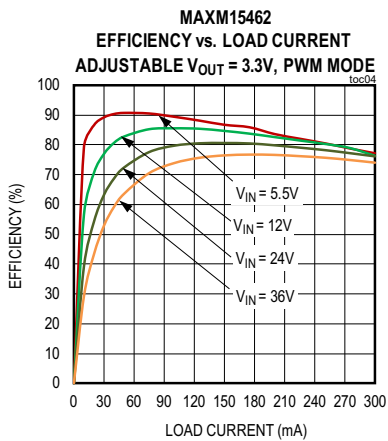
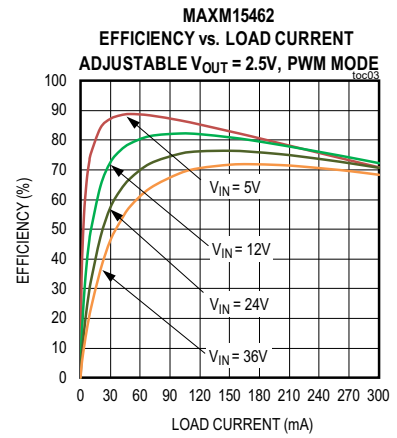
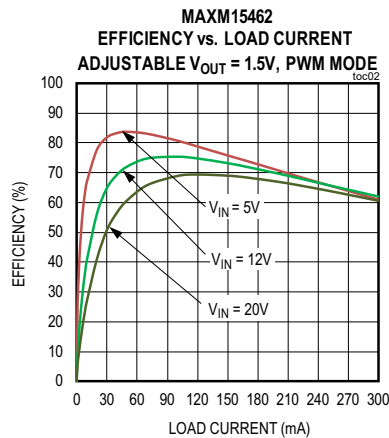
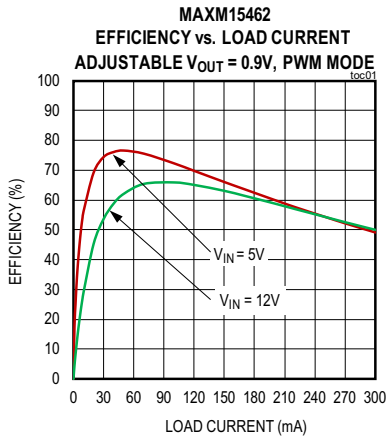

Typical Operating Characteristics (continued)

($V_{IN} = V_{EN/UVLO} = 24V$, $V_{GND} = 0V$, $T_A = -40^{\circ}C$ to $+125^{\circ}C$, unless otherwise noted. Typical values are at $T_A = +25^{\circ}C$. All voltages are referenced to GND, unless otherwise noted. The circuit values for different output-voltage applications are as in Table 1, unless otherwise noted.)

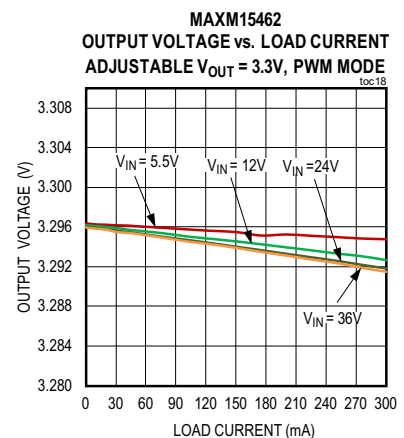
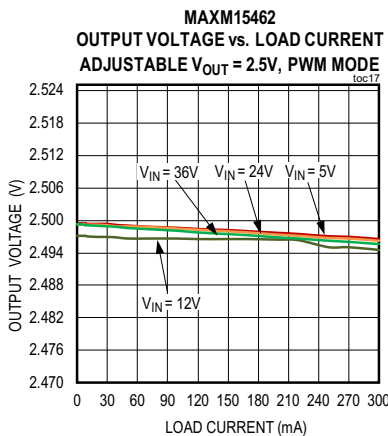
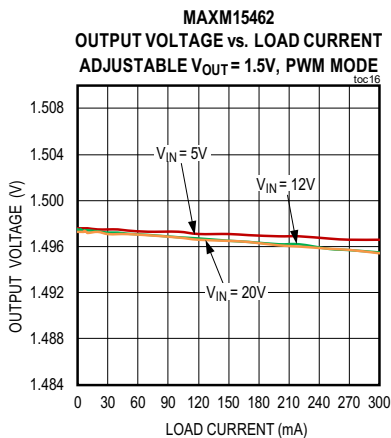
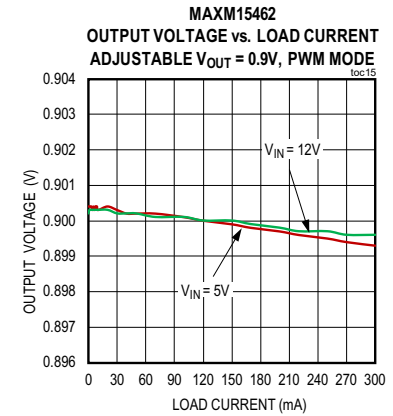
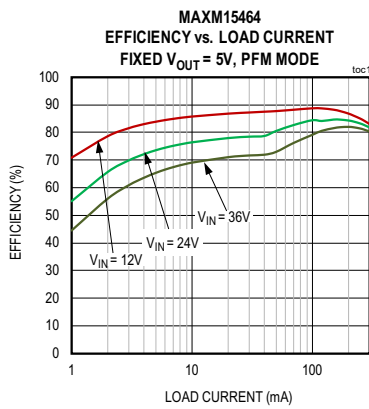
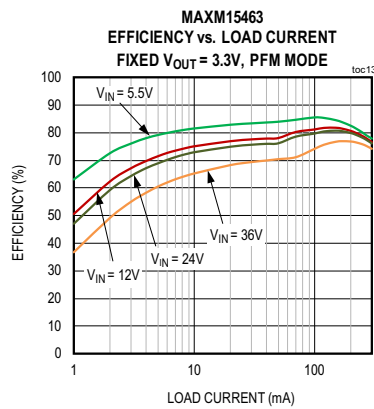
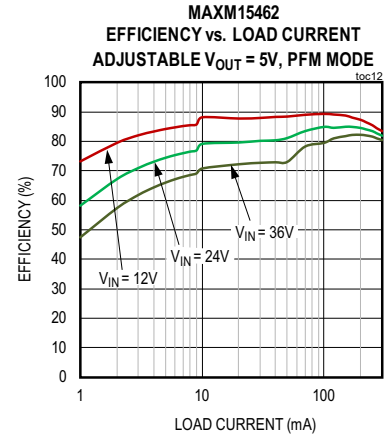
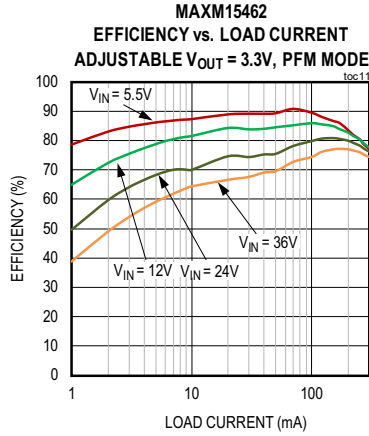
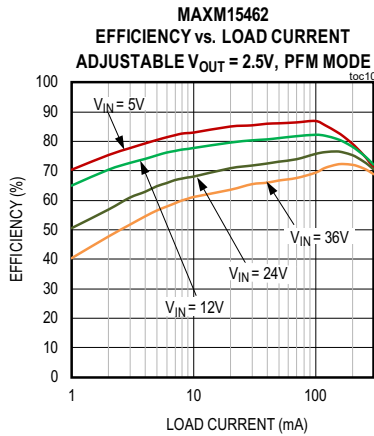

Typical Operating Characteristics (continued)

($V_{IN} = V_{EN/UVLO} = 24V$, $V_{GND} = 0V$, $T_A = -40^{\circ}C$ to $+125^{\circ}C$, unless otherwise noted. Typical values are at $T_A = +25^{\circ}C$. All voltages are referenced to GND, unless otherwise noted. The circuit values for different output-voltage applications are as in Table 1, unless otherwise noted.)

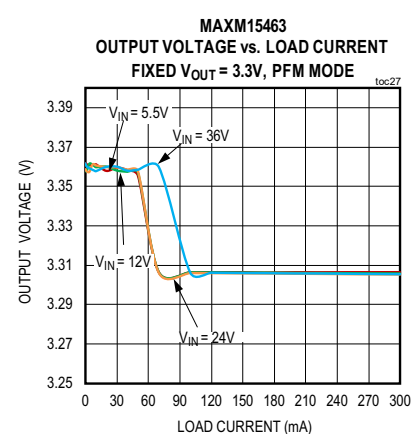
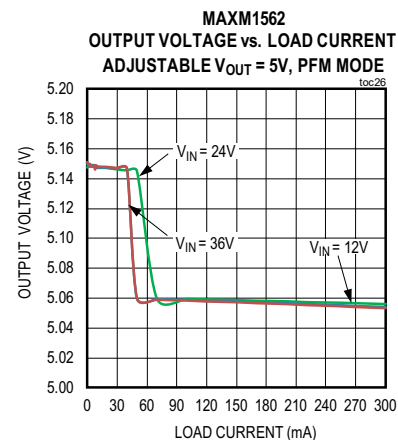
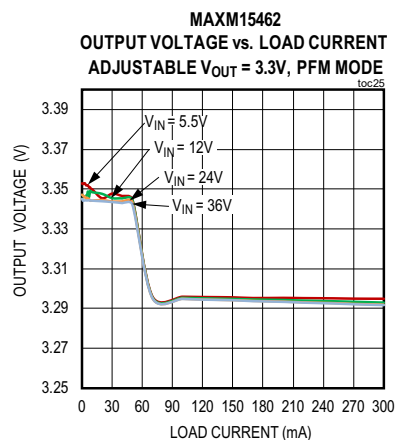
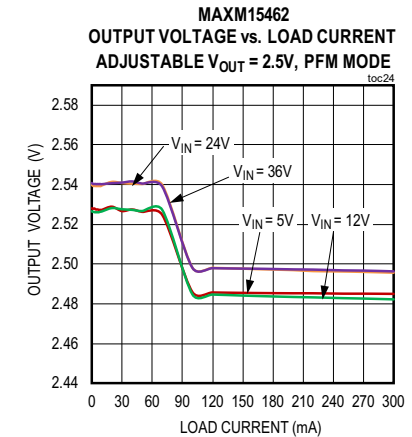
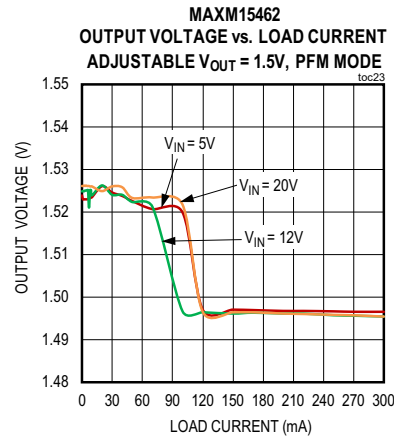
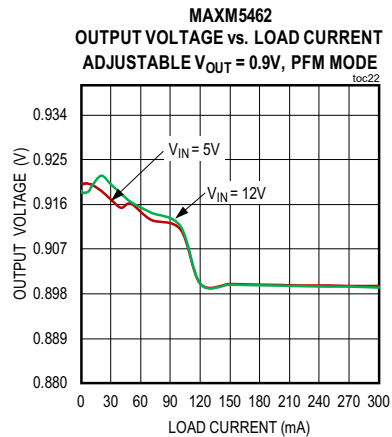
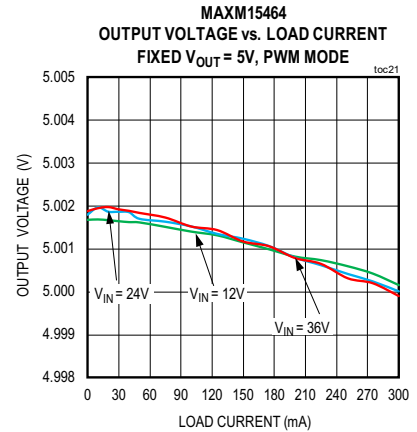
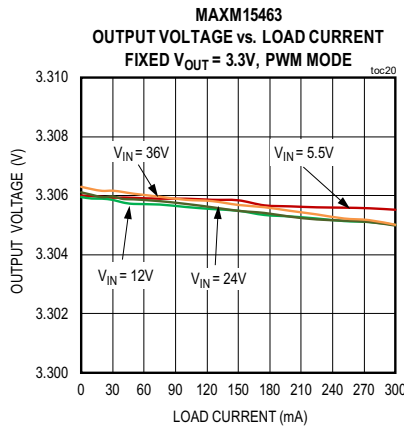
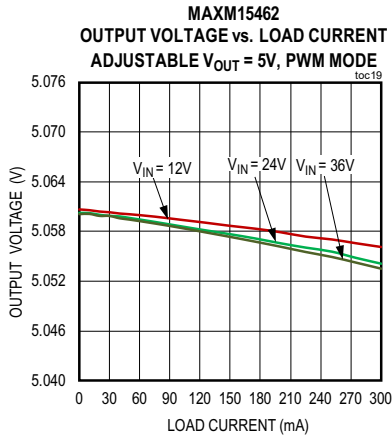

Typical Operating Characteristics (continued)

($V_{IN} = V_{EN/UVLO} = 24V$, $V_{GND} = 0V$, $T_A = -40^{\circ}C$ to $+125^{\circ}C$, unless otherwise noted. Typical values are at $T_A = +25^{\circ}C$. All voltages are referenced to GND, unless otherwise noted. The circuit values for different output-voltage applications are as in [Table 1](#), unless otherwise noted.)

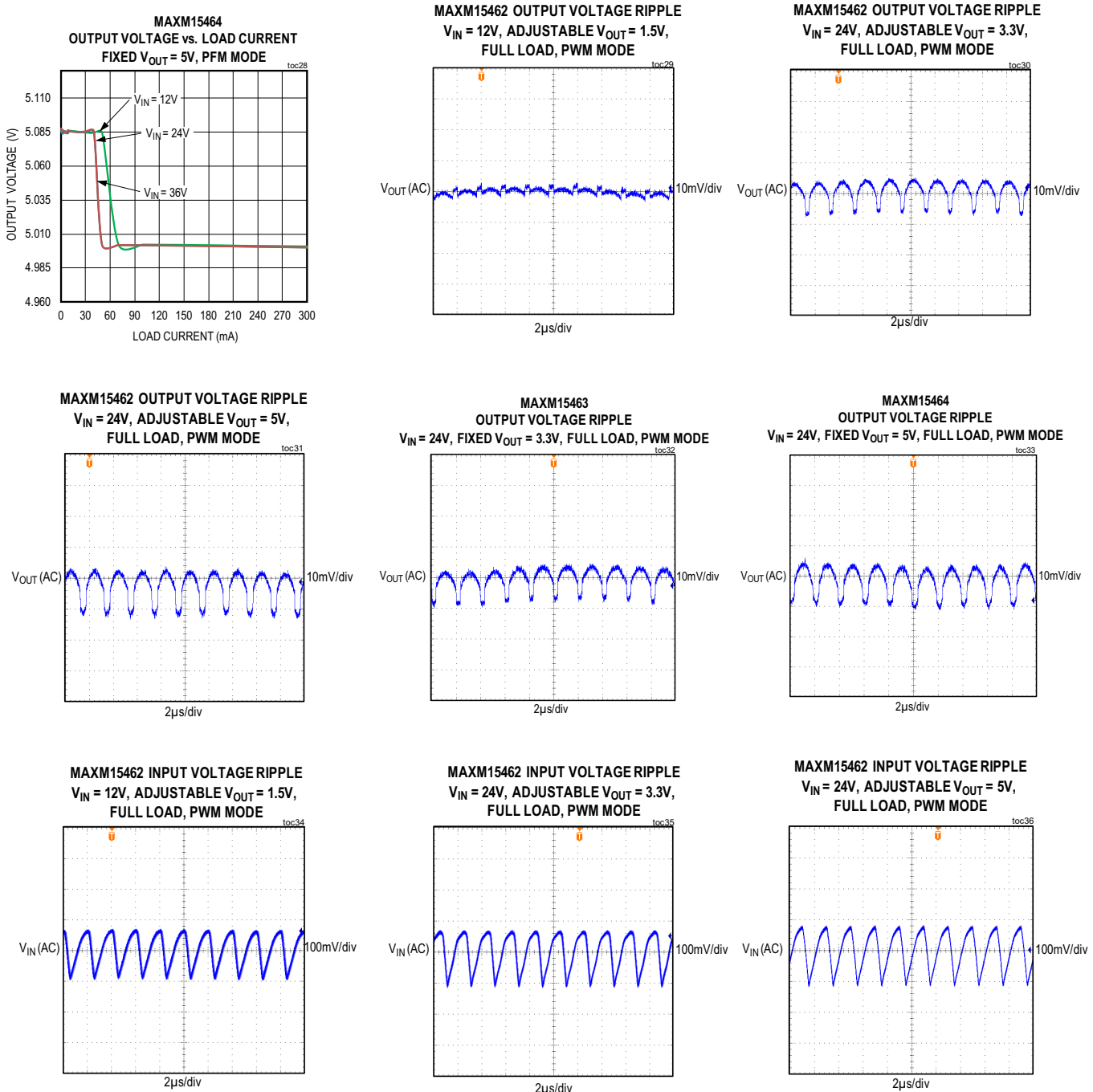

Typical Operating Characteristics (continued)

($V_{IN} = V_{EN/UVLO} = 24V$, $V_{GND} = 0V$, $T_A = -40^{\circ}C$ to $+125^{\circ}C$, unless otherwise noted. Typical values are at $T_A = +25^{\circ}C$. All voltages are referenced to GND, unless otherwise noted. The circuit values for different output-voltage applications are as in [Table 1](#), unless otherwise noted.)

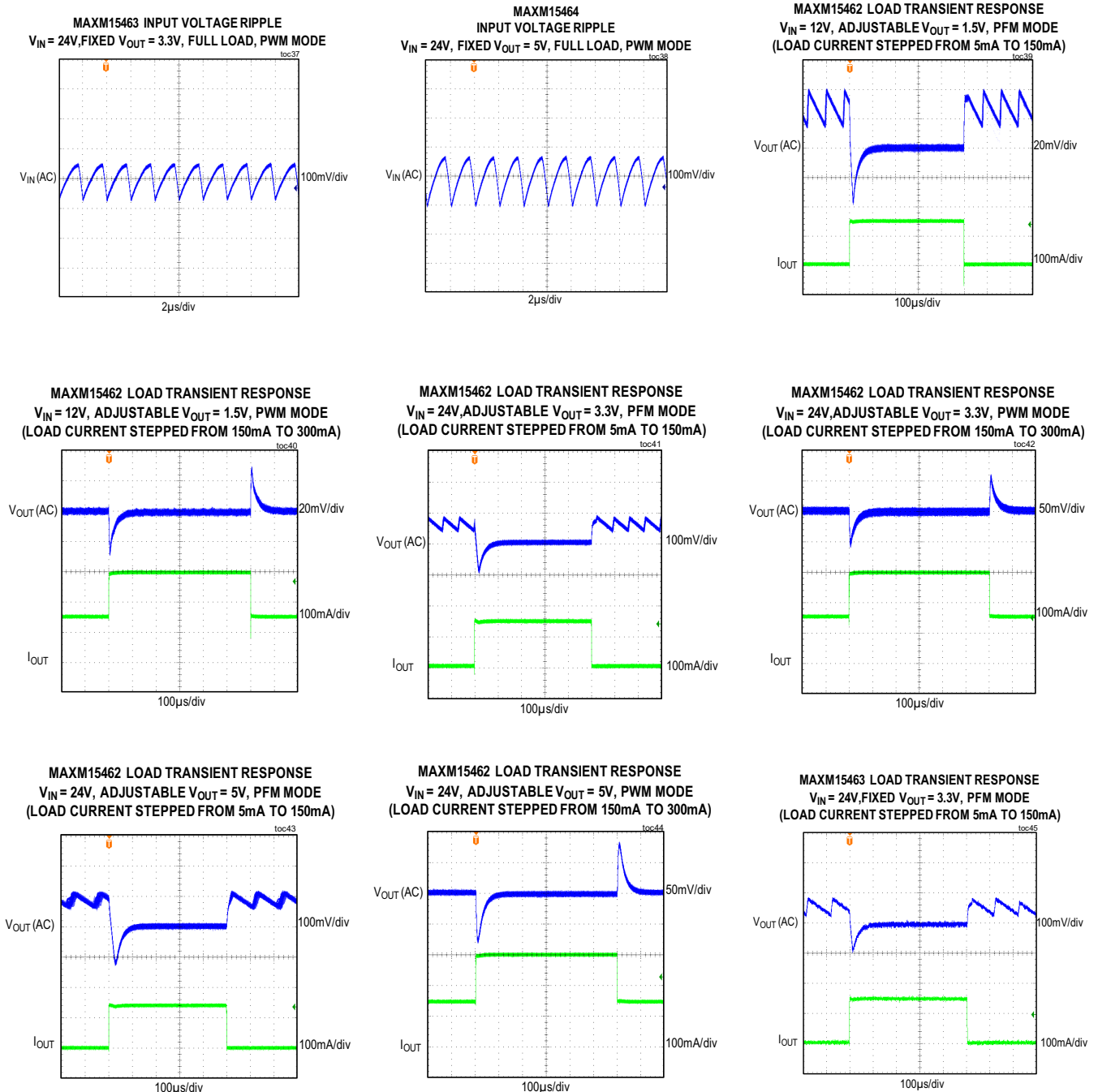

Typical Operating Characteristics (continued)

($V_{IN} = V_{EN/UVLO} = 24V$, $V_{GND} = 0V$, $T_A = -40^{\circ}C$ to $+125^{\circ}C$, unless otherwise noted. Typical values are at $T_A = +25^{\circ}C$. All voltages are referenced to GND, unless otherwise noted. The circuit values for different output-voltage applications are as in Table 1, unless otherwise noted.)

MAXM15463 LOAD TRANSIENT RESPONSE
 $V_{IN} = 24V$, FIXED $V_{OUT} = 3.3V$, PWM MODE
(LOAD CURRENT STEPPED FROM 150mA TO 300mA)

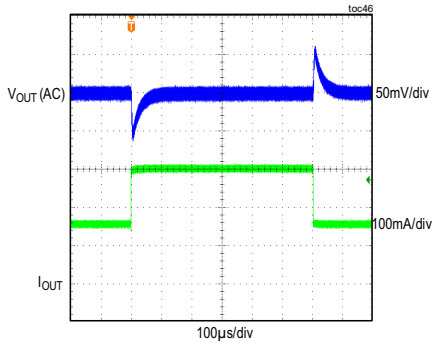

MAXM15464 LOAD TRANSIENT RESPONSE
 $V_{IN} = 24V$, FIXED $V_{OUT} = 5V$, PFM MODE
(LOAD CURRENT STEPPED FROM 5mA TO 150mA)

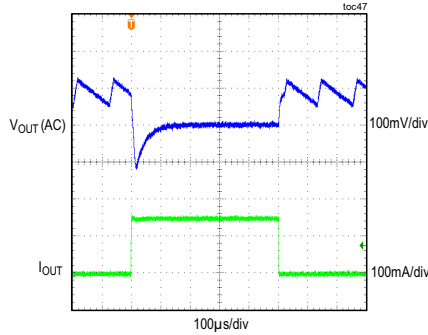

MAXM15464 LOAD TRANSIENT RESPONSE
 $V_{IN} = 24V$, FIXED $V_{OUT} = 5V$, PWM MODE
(LOAD CURRENT STEPPED FROM 150mA TO 300mA)

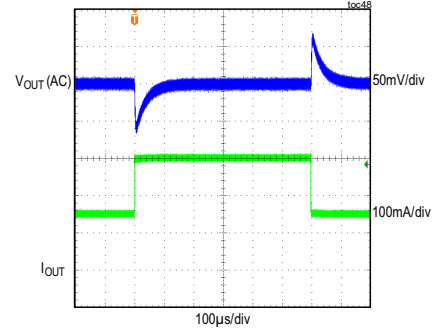

MAXM15462 STARTUP THROUGH ENABLE
 $V_{IN} = 12V$, ADJUSTABLE $V_{OUT} = 1.5V$,
FULL LOAD, PWM MODE

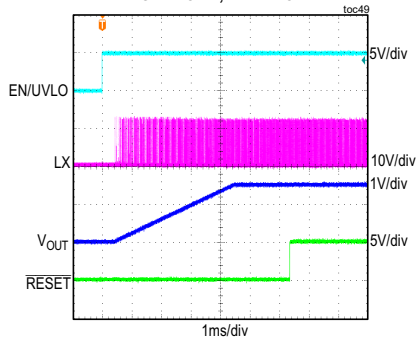

MAXM15462 SHUTDOWN THROUGH ENABLE
 $V_{IN} = 12V$, ADJUSTABLE $V_{OUT} = 1.5V$,
FULL LOAD, PWM MODE

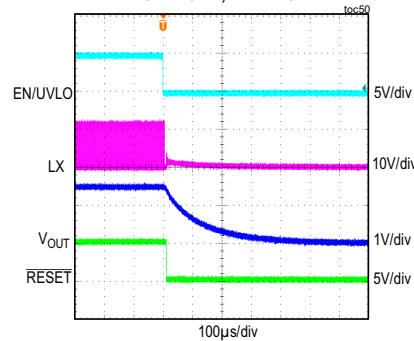

MAXM15462 STARTUP THROUGH ENABLE
 $V_{IN} = 24V$, ADJUSTABLE $V_{OUT} = 3.3V$,
FULL LOAD, PWM MODE

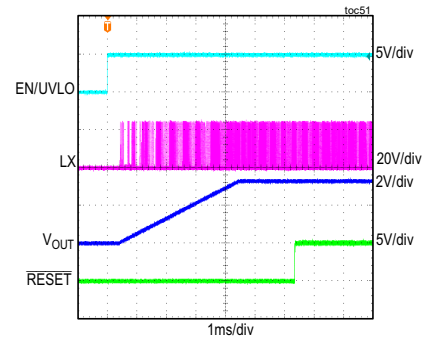

MAXM15462 SHUTDOWN THROUGH ENABLE
 $V_{IN} = 24V$, ADJUSTABLE $V_{OUT} = 3.3V$,
FULL LOAD, PWM MODE

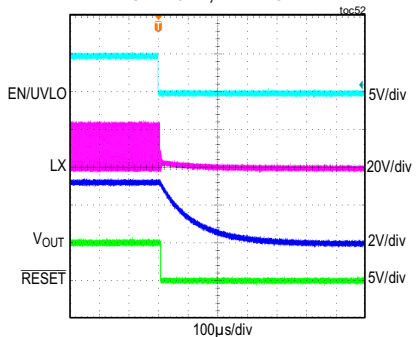

MAXM15462 STARTUP THROUGH ENABLE
2V PREBIAS, $V_{IN} = 24V$, ADJUSTABLE $V_{OUT} = 3.3V$,
NO LOAD, PFM MODE

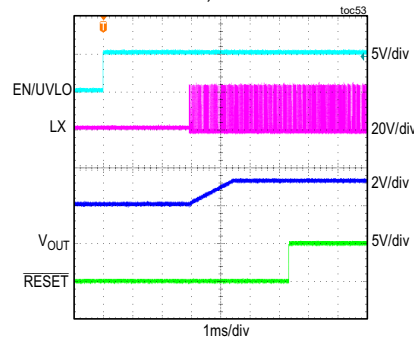

MAXM15462 STARTUP THROUGH ENABLE
(2V PREBIAS) $V_{IN} = 24V$, ADJUSTABLE $V_{OUT} = 3.3V$,
NO LOAD, PFM MODE

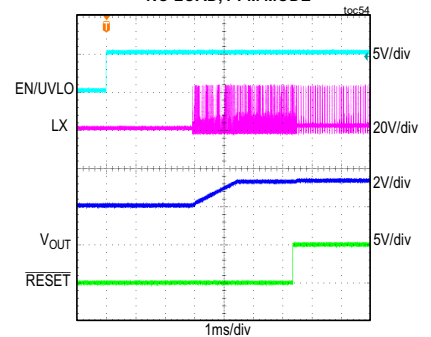

Typical Operating Characteristics (continued)

($V_{IN} = V_{EN/UVLO} = 24V$, $V_{GND} = 0V$, $T_A = -40^{\circ}C$ to $+125^{\circ}C$, unless otherwise noted. Typical values are at $T_A = +25^{\circ}C$. All voltages are referenced to GND, unless otherwise noted. The circuit values for different output-voltage applications are as in [Table 1](#), unless otherwise noted.)

MAXM15462 STARTUP THROUGH ENABLE
 $V_{IN} = 24V$, ADJUSTABLE $V_{OUT} = 5V$,
FULL LOAD, PWM MODE

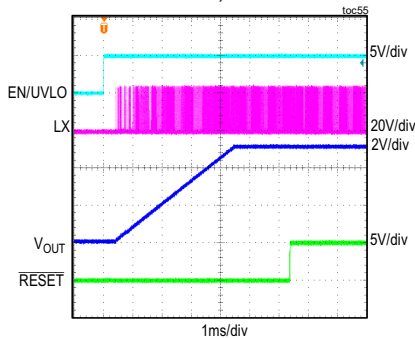

MAXM15462 SHUTDOWN THROUGH ENABLE
 $V_{IN} = 24V$, ADJUSTABLE $V_{OUT} = 5V$,
FULL LOAD, PWM MODE

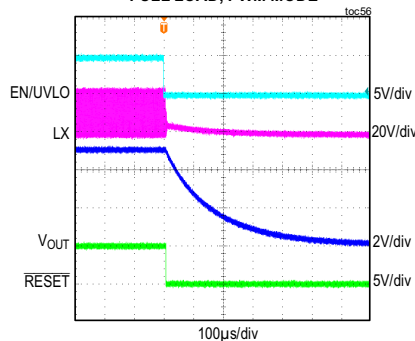

MAXM15463 STARTUP THROUGH ENABLE
 $V_{IN} = 24V$, FIXED $V_{OUT} = 3.3V$, FULL LOAD, PWM MODE

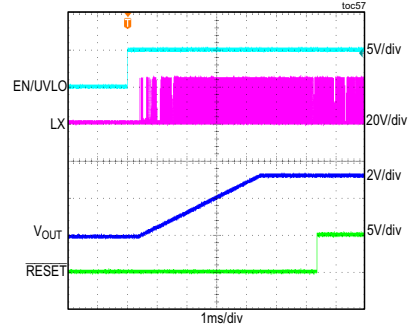

MAXM15463 SHUTDOWN THROUGH ENABLE
 $V_{IN} = 24V$, FIXED $V_{OUT} = 3.3V$, FULL LOAD, PWM MODE

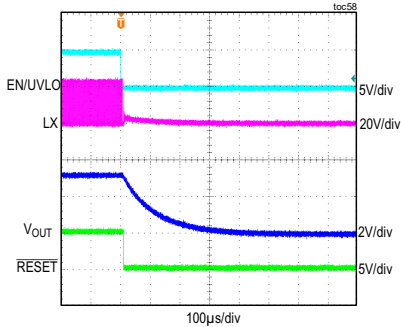

MAXM15463 STARTUP THROUGH ENABLE (2V PREBIAS)
 $V_{IN} = 24V$, FIXED $V_{OUT} = 3.3V$, NO LOAD, PWM MODE

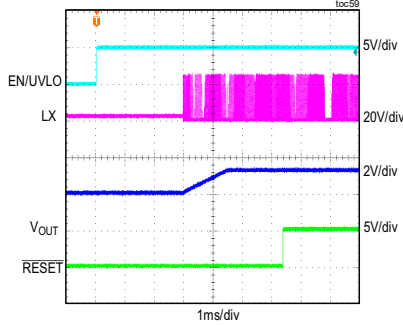

MAXM15463 STARTUP THROUGH ENABLE (2V PREBIAS)
 $V_{IN} = 24V$, FIXED $V_{OUT} = 3.3V$, NO LOAD, PFM MODE

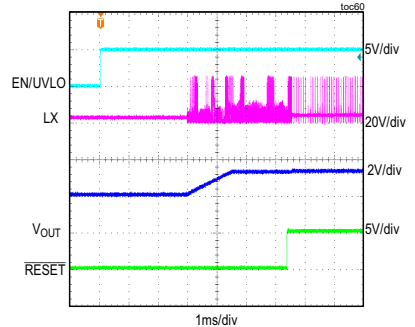

MAXM15464 STARTUP THROUGH ENABLE
 $V_{IN} = 24V$, FIXED $V_{OUT} = 5V$, FULL LOAD, PWM MODE

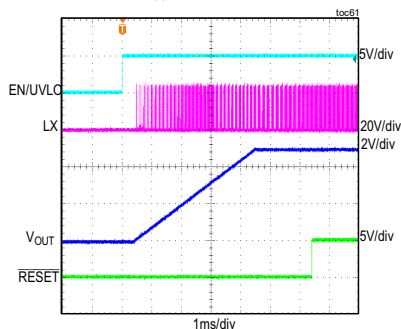

MAXM15464 SHUTDOWN THROUGH ENABLE
 $V_{IN} = 24V$, FIXED $V_{OUT} = 5V$, FULL LOAD, PWM MODE

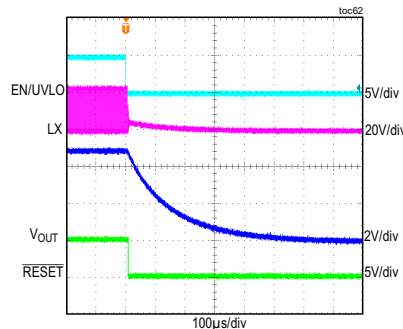

MAXM15464 STARTUP THROUGH ENABLE (2.5V PREBIAS)
 $V_{IN} = 24V$, FIXED $V_{OUT} = 5V$, NO LOAD, PWM MODE

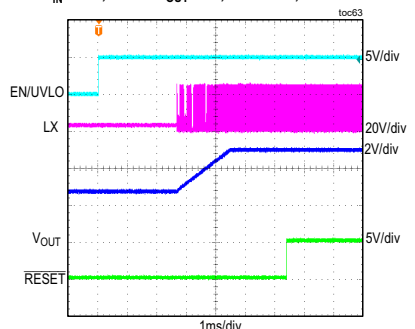

Typical Operating Characteristics (continued)

($V_{IN} = V_{EN/UVLO} = 24V$, $V_{GND} = 0V$, $T_A = -40^{\circ}C$ to $+125^{\circ}C$, unless otherwise noted. Typical values are at $T_A = +25^{\circ}C$. All voltages are referenced to GND, unless otherwise noted. The circuit values for different output-voltage applications are as in [Table 1](#), unless otherwise noted.)

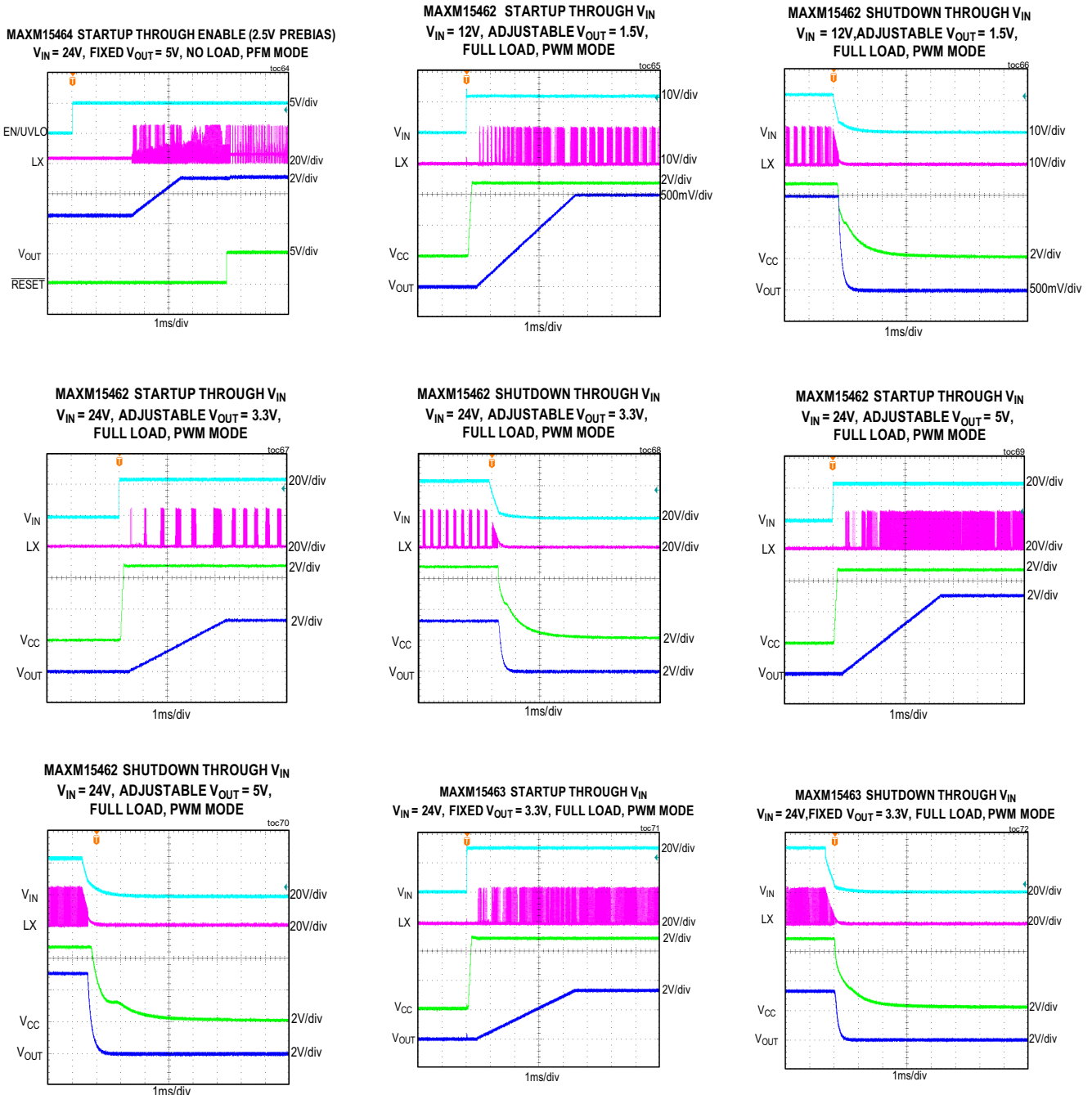

Typical Operating Characteristics (continued)

($V_{IN} = V_{EN/UVLO} = 24V$, $V_{GND} = 0V$, $T_A = -40^{\circ}C$ to $+125^{\circ}C$, unless otherwise noted. Typical values are at $T_A = +25^{\circ}C$. All voltages are referenced to GND, unless otherwise noted. The circuit values for different output-voltage applications are as in Table 1, unless otherwise noted.)

MAXM15464 STARTUP THROUGH V_{IN}
 $V_{IN} = 24V$, FIXED $V_{OUT} = 5V$, FULL LOAD, PWM MODE

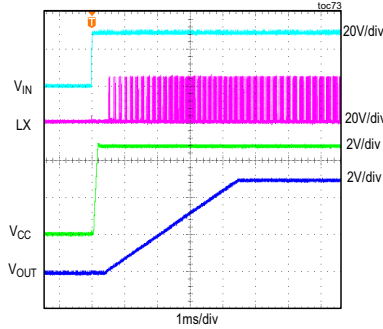

MAXM15464 SHUTDOWN THROUGH V_{IN}
 $V_{IN} = 24V$, FIXED $V_{OUT} = 5V$, FULL LOAD, PWM MODE

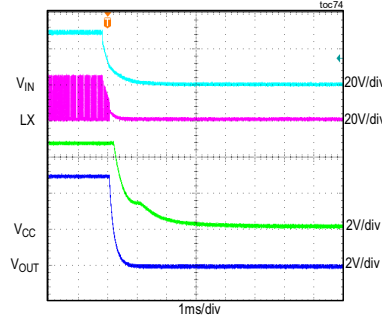

MAXM15462 OUTPUT SHORT IN STEADY STATE
 $V_{IN} = 24V$, ADJUSTABLE $V_{OUT} = 3.3V$,
FULL LOAD, PWM MODE

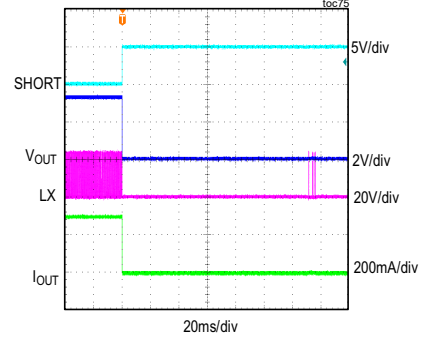

MAXM15462 OUTPUT SHORT DURING STARTUP
 $V_{IN} = 24V$, $V_{OUT} = 3.3V$, FULL LOAD, PWM MODE

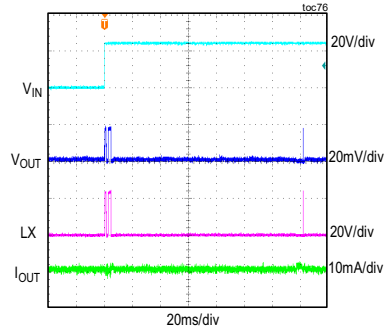

MAXM15463 OUTPUT SHORT IN STEADY STATE
 $V_{IN} = 24V$, FIXED $V_{OUT} = 3.3V$, FULL LOAD, PWM MODE

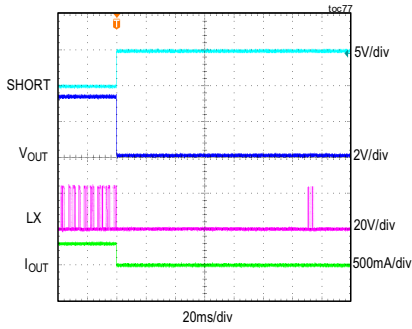

MAXM15463 OUTPUT SHORT DURING STARTUP
 $V_{IN} = 24V$, FIXED $V_{OUT} = 3.3V$, FULL LOAD, PWM MODE

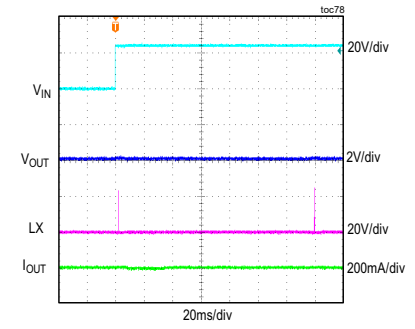

MAXM15464 OUTPUT SHORT IN STEADY STATE
 $V_{IN} = 24V$, FIXED $V_{OUT} = 5V$, FULL LOAD, PWM MODE

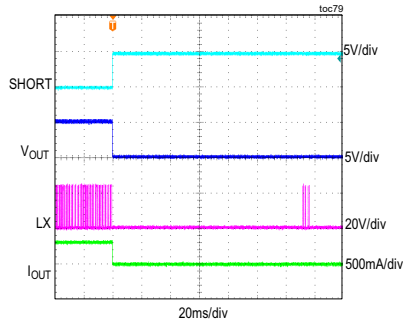

MAXM15464 OUTPUT SHORT DURING STARTUP
 $V_{IN} = 24V$, FIXED $V_{OUT} = 5V$, FULL LOAD, PWM MODE

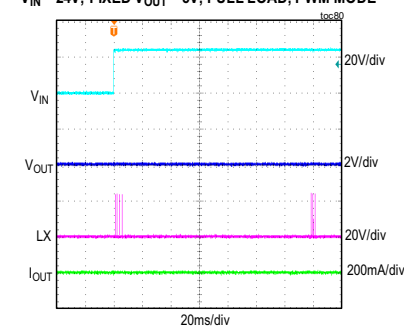

MAXM15462 BODE PLOT
 $V_{IN} = 12V$, ADJUSTABLE $V_{OUT} = 1.5V$,
FULL LOAD, PWM MODE

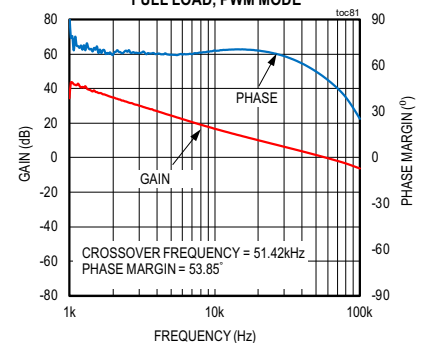

Typical Operating Characteristics (continued)

($V_{IN} = V_{EN}/UVLO = 24V$, $V_{GND} = 0V$, $T_A = -40^{\circ}C$ to $+125^{\circ}C$, unless otherwise noted. Typical values are at $T_A = +25^{\circ}C$. All voltages are referenced to GND, unless otherwise noted. The circuit values for different output-voltage applications are as in Table 1, unless otherwise noted.)

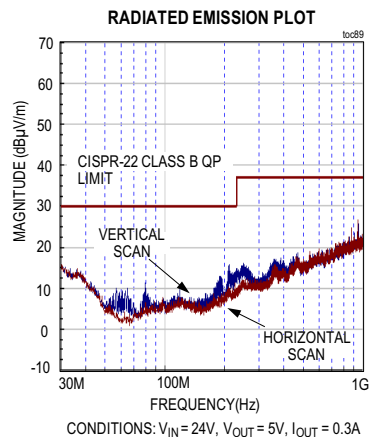
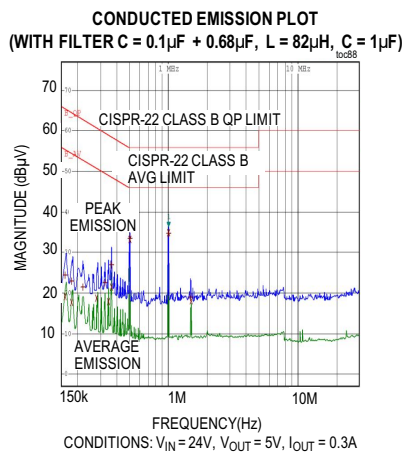
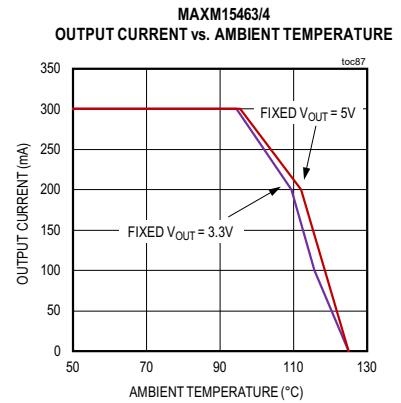
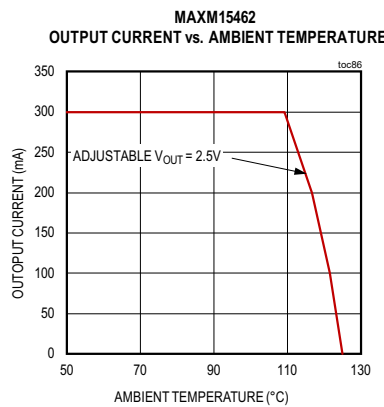
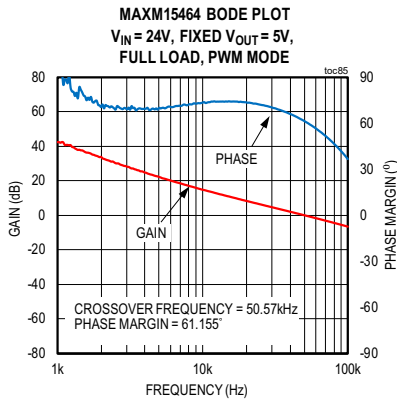
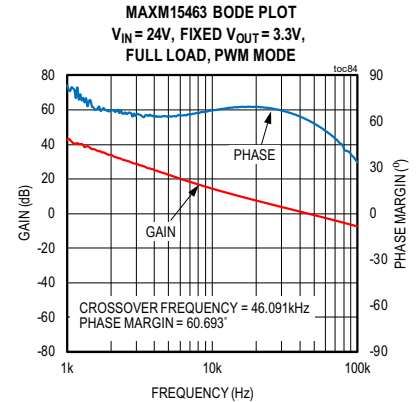
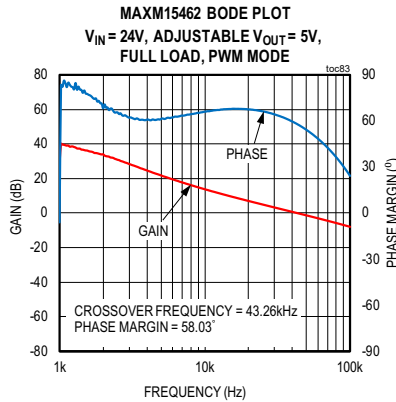
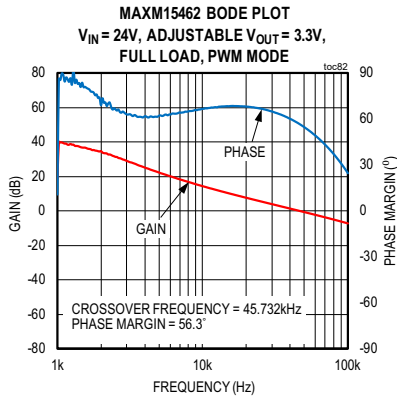

Pin Configuration

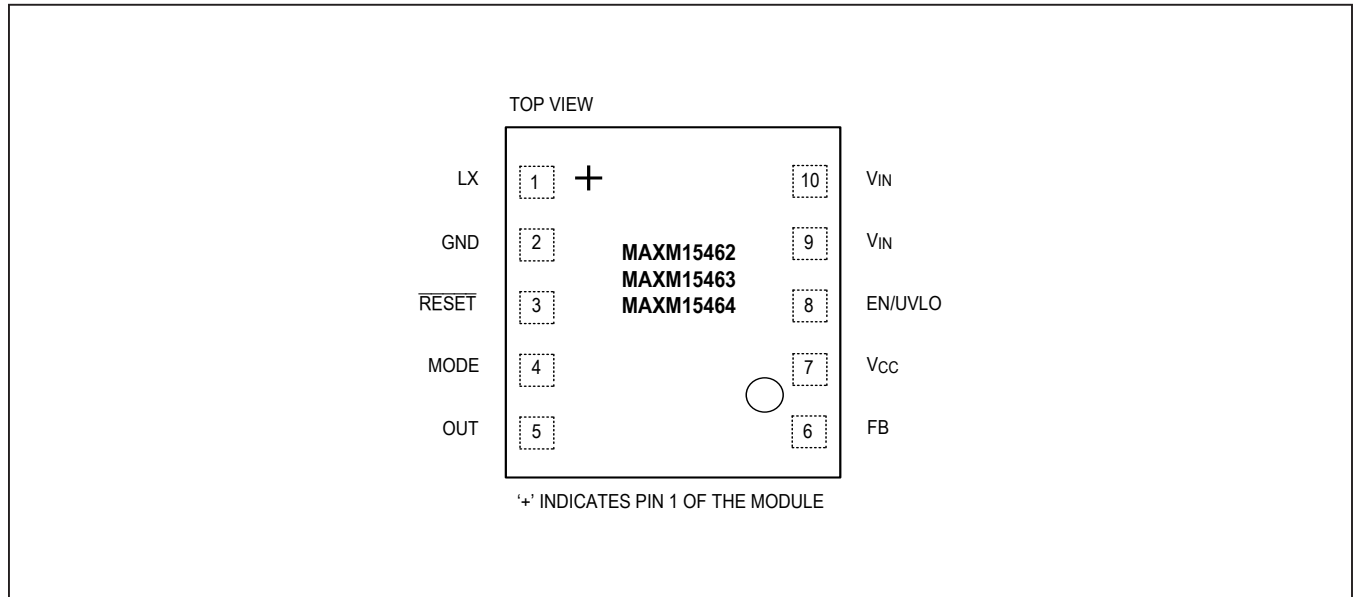

Pin Description

PIN	NAME	FUNCTION
1	LX	Switching Node of the Inductor. No external connection to this pin.
2	GND	Ground Pin. Connect GND to the ground plane. See the PCB Layout Guidelines section for more details. Refer to the MAXM15462 EV kit for a sample layout.
3	RESET	Open-Drain Power-Good Output. Pull up RESET to an external power supply with an external resistor. RESET goes low if FB drops below 92% of its set value. RESET goes high impedance 2ms after FB rises above 95.5% of its set value. See the Electrical Characteristics table for threshold values.
4	MODE	PFM/PWM Mode-Selection Input. Connect MODE to GND to enable fixed-frequency PWM operation at all loads. Leave MODE unconnected for PFM operation at light load.
5	OUT	Module Output Pin. Connect a capacitor from OUT to GND. See the PCB Layout Guidelines section for more details.
6	FB	Output Feedback Connection. Connect FB to a resistor-divider between OUT and GND to set the output voltage for MAXM15462. Connect to output voltage node (V _{OUT}) for MAXM15463 and MAXM15464. See Output-Voltage Setting section for more details.
7	V _{CC}	Internal LDO Power Output. Bypass V _{CC} to GND with a minimum 1μF ceramic capacitor.
8	EN/UVLO	Active-High, Enable/Undervoltage-Detection Input. Pull EN/UVLO to GND to disable the module output. Connect EN/UVLO to V _{IN} for always-on operation. Connect a resistor-divider between V _{IN} , EN/UVLO, and GND to program the input voltage at which the module turns on.
9–10	V _{IN}	Power-Supply Input. Connect the V _{IN} pins together. Decouple to GND with a capacitor; place the capacitor close to the V _{IN} and GND pins. See Table 1 for more details.

Functional Diagrams

Internal Diagram

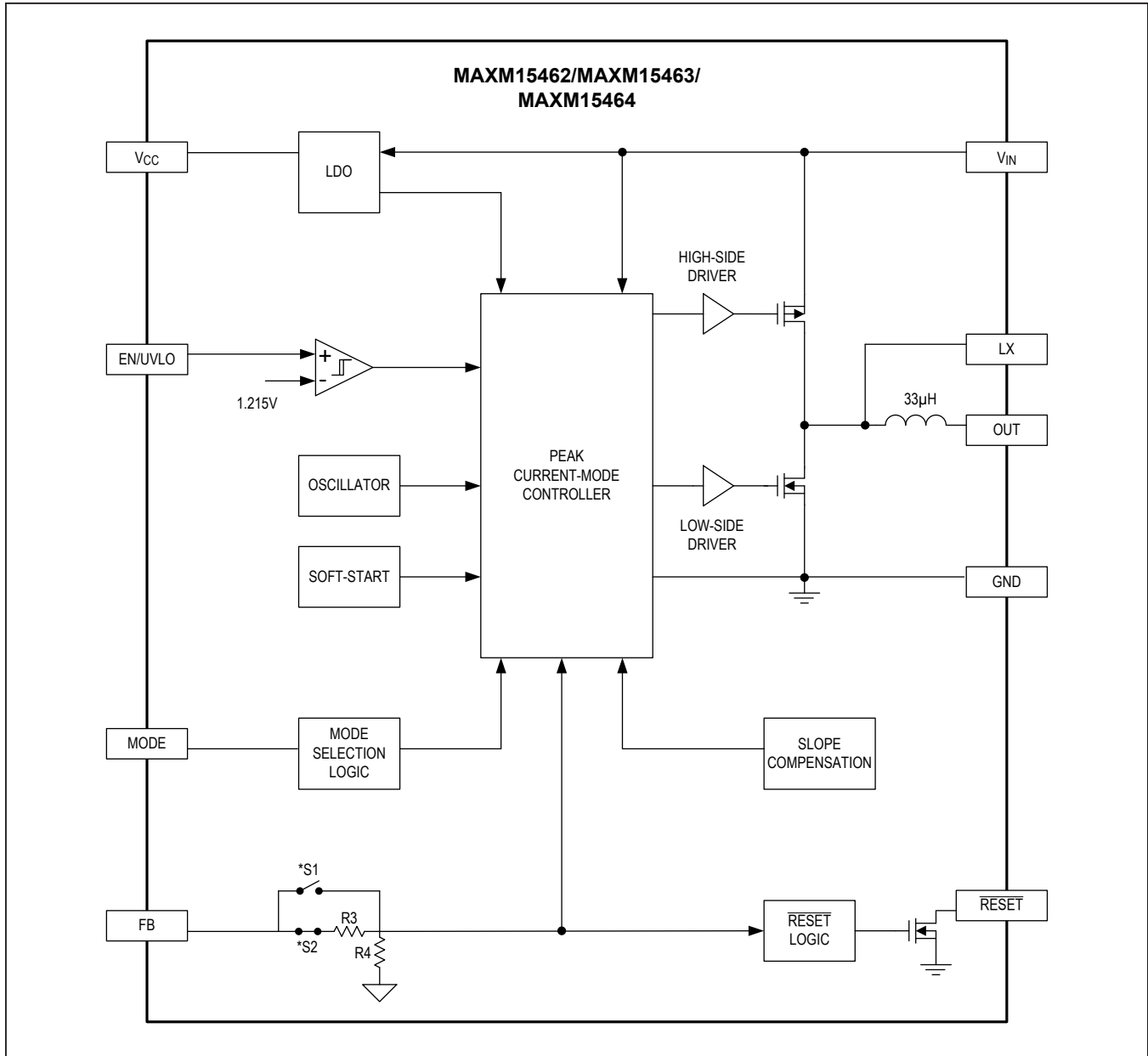

Table A

MODULE PART NUMBER	S1	S2	R3 (KΩ)	R4 (KΩ)
MAXM15462	CLOSE	OPEN	OPEN	OPEN
MAXM15463	OPEN	CLOSE	205.33	77
MAXM15464	OPEN	CLOSE	350.80	77

Detailed Description

The MAXM15462/MAXM15463/MAXM15464 are a family of high-efficiency, synchronous step-down DC-DC modules with integrated controller, MOSFETs, compensation components, and inductor that operate over a wide input-voltage range. The modules deliver an output current up to 300mA. The MAXM15463 and MAXM15464 are fixed 3.3V and 5V output modules respectively. The MAXM15462 is an adjustable output (0.9V to 5V) module. When EN/UVLO and V_{CC} UVLO are ascertained, an internal power-up sequence ramps up the error-amplifier reference, resulting in an output-voltage soft-start.

The FB pin monitors the output voltage through a resistor-divider. The $\overline{\text{RESET}}$ pin transitions to a high-impedance state 2ms after the output voltage reaches 95.5% of regulation. The devices select either PFM or forced-PWM mode depending on the state of the MODE pin at power-up. By pulling the EN/UVLO pin to low, the devices enter shutdown mode and consumes only 2.2 μ A (typ) of standby current.

The modules use an internally compensated, fixed-frequency, current-mode control scheme. On the rising edge of an internal clock, the high-side pMOSFET turns on. An internal error amplifier compares the feedback voltage to a fixed internal reference voltage and generates an error voltage. The error voltage is compared to a sum of the current-sense voltage and a slope-compensation voltage by a PWM comparator to set the on-time. During the on-time of the pMOSFET, the inductor current ramps up. For the remainder of the switching period (off-time), the pMOSFET is kept off and the low-side nMOSFET turns on. During the off-time, the inductor releases the stored energy as the inductor current ramps down, providing current to the output. Under overload conditions, the cycle-by-cycle current-limit feature limits the inductor peak current by turning off the high-side pMOSFET and turning on the low-side nMOSFET.

Mode Selection (MODE)

The logic state of the MODE pin is latched after V_{CC} and EN/UVLO voltages exceed respective UVLO rising thresholds and all internal voltages are ready to allow LX switching. If the MODE pin is unconnected at power-up, the part operates in PFM mode at light loads. If the MODE pin is grounded at power-up, the part operates in constant-frequency PWM mode at all loads. State changes on the MODE pin are ignored during normal operation.

PWM Operation

In PWM mode, the module output current is allowed to go negative. PWM operation is useful in frequency sensitive applications and provides fixed switching frequency

operation at all loads. However, PWM-mode of operation gives lower efficiency at light loads compared to PFM-mode of operation.

PFM Operation

PFM mode operation disables negative output current from the module, and skips pulses at light loads for better efficiency. In PFM mode, the module output current is forced to a fixed peak of 130mA in every clock cycle until the output voltage rises to 102.3% of the nominal value. Once the output voltage reaches 102.3% of the nominal value, the high-side switch is turned off and the low-side switch is turned on. Once the module output current hits zero cross, LX goes to a high-impedance state and the module enters hibernate operation until the load current discharges the output voltage to 101.1% of the nominal value. Most of the internal blocks are turned off in hibernate operation to save quiescent current. When the output voltage falls below 101.1% of the nominal value, the module comes out of hibernate operation, turns on all internal blocks, and commences the process of delivering pulses of energy until the output voltage reaches 102.3% of the nominal value. The module naturally comes out of PFM mode and serves load requirements when the module output demands more than 130mA peak. The advantage of PFM mode is higher efficiency at light loads because of lower quiescent current drawn from supply.

Internal 5V Regulator

An internal regulator provides a 5V nominal supply to power the internal functions and to drive the power MOSFETs. The output of the linear regulator (V_{CC}) should be bypassed with a 1 μ F ceramic capacitor to GND. The V_{CC} regulator dropout voltage is typically 150mV. An undervoltage lockout circuit that disables the buck converter when V_{CC} falls below 3.8V (typ). The 400mV, V_{CC} -UVLO hysteresis prevents chattering on power-up and power-down.

Enable/Undervoltage Lockout (EN/UVLO), Soft-Start

When EN/UVLO voltage is above 1.215V (typ), the device's internal error-amplifier reference voltage starts to ramp up. The duration of the soft-start ramp is 4.1ms (typ), allowing a smooth increase of the output voltage. Driving EN/UVLO low disables both power MOSFETs, as well as other internal circuitry, and reduces V_{IN} quiescent current to below 2.2 μ A. EN/UVLO can be used as an input-voltage UVLO adjustment input. An external voltage-divider between V_{IN} and EN/UVLO to GND adjusts the input voltage at which the device turns on or turns off. If input UVLO programming is not desired, connect EN/UVLO to V_{IN} (see the [Electrical Characteristics](#) table for EN/UVLO rising and falling threshold voltages).

RESET Output ($\overline{\text{RESET}}$)

The devices include an open-drain $\overline{\text{RESET}}$ output to monitor the output voltage. $\overline{\text{RESET}}$ goes high impedance 2ms after the output rises above 95.5% of its nominal set value and pulls low when the output voltage falls below 92% of the set nominal regulated voltage. $\overline{\text{RESET}}$ asserts low during the hiccup timeout period.

Startup into a Prebiased Output

The devices are capable of soft-start into a prebiased output, without discharging the output capacitor in both the PFM and forced-PWM modes. Such a feature is useful in applications where digital integrated circuits with multiple rails are powered.

Overcurrent Protection (OCP)/Hiccup Mode

The MAXM15462/MAXM15463/MAXM15464 are provided with a robust overcurrent protection (OCP) scheme that protects the modules under overload and output short-circuit conditions. The power module measures and limits peak inductor current. When overcurrent is detected in the inductor, or if the FB node goes below 64.5% of its nominal regulation threshold, the module enters hiccup mode of operation. In hiccup mode, the module is protected by suspending switching for a hiccup timeout period of 131ms (typ). Once the hiccup timeout period expires, soft-start is attempted again. Hiccup mode of operation ensures low power dissipation under output overload or short-circuit conditions. Once the hiccup timeout period expires, soft-start is attempted again.

The MAXM15462/3/4 are designed to support a maximum load current of 300mA. The inductor ripple current is calculated as follows:

$$\Delta I = \left[\frac{V_{\text{IN}} - V_{\text{OUT}} - 4.85 \times I_{\text{OUT}}}{L \times f_{\text{SW}}} \right] \times \left[\frac{V_{\text{OUT}} + 3.05 \times I_{\text{OUT}}}{V_{\text{IN}} - 1.8 \times I_{\text{OUT}}} \right]$$

Where:

V_{OUT} = Steady-state output voltage

V_{IN} = Operating input voltage for given V_{OUT}

f_{SW} = Switching Frequency

L = Power module output inductance (33 μH \pm 30%)

I_{OUT} = Required output (load) current

The following condition should be satisfied at the desired load current, I_{OUT} .

$$I_{\text{OUT}} + \frac{\Delta I}{2} < 0.49$$

Thermal Overload Protection

Thermal overload protection limits the total power dissipation in the device. When the junction temperature exceeds +166°C, an on-chip thermal sensor shuts down the device, turns off the internal power MOSFETs, allowing the device to cool down. The thermal sensor turns the device on after the junction temperature cools by 10°C.

Applications Information

Input-Voltage Range

The minimum and maximum operating input voltages for a given output voltage should be calculated as follows:

$$V_{\text{IN(MIN)}} = \frac{V_{\text{OUT}} + (I_{\text{OUT}} \times 3.05)}{D_{\text{MAX}}} + (I_{\text{OUT}} \times 1.8)$$

$$V_{\text{IN(MAX)}} = \frac{V_{\text{OUT}}}{t_{\text{ON(MIN)}} \times f_{\text{SW}}}$$

where:

V_{OUT} = Steady-state output voltage,

I_{OUT} = Maximum load current,

f_{SW} = Worst-case switching frequency(535000 Hz),

D_{MAX} = Maximum duty cycle (0.89),

$t_{\text{ON(MIN)}}$ = Worst-case minimum controllable switch on-time (130ns).

Also, for duty cycle > 0.5;

$$V_{\text{IN(MIN)}} > ((4.27 \times V_{\text{OUT}}) - 9.76)$$

For MAXM15463, $V_{\text{IN(MIN)}} = 5.5\text{V}$, $V_{\text{IN(MAX)}} = 42\text{V}$

For MAXM15464, $V_{\text{IN(MIN)}} = 12\text{V}$, $V_{\text{IN(MAX)}} = 42\text{V}$

Selection of Input Capacitor

The input filter capacitor reduces peak currents drawn from the power source and reduces noise and voltage ripple on the input caused by the converter's switching.

The input capacitor RMS current requirement (I_{RMS}) is defined by the following equation:

$$I_{\text{RMS}} = I_{\text{OUT(MAX)}} \times \sqrt{\frac{V_{\text{OUT}} \times (V_{\text{IN}} - V_{\text{OUT}})}{V_{\text{IN}}}}$$

where, $I_{\text{OUT(MAX)}}$ is the maximum load current. I_{RMS} has a maximum value when the input voltage equals twice the output voltage ($V_{\text{IN}} = 2 \times V_{\text{OUT}}$). So,

$$I_{\text{RMS(MAX)}} = \frac{I_{\text{OUT(MAX)}}}{2}$$

MAXM15462/MAXM15463/ MAXM15464

4.5V to 42V, 300mA Himalaya uSLIC Step-Down Power Module

Choose an input capacitor that exhibits less than a +10°C temperature rise at the RMS input current for optimal long-term reliability. Use low-ESR ceramic capacitors with high-ripple-current capability at the input. X7R capacitors are recommended in industrial applications for their temperature stability. Calculate the input capacitance using the following equation:

$$C_{IN} = \frac{I_{OUT(MAX)} \times D_{MAX} \times (1 - D_{MAX})}{f_{SW} \times \Delta V_{IN}}$$

where:

D_{MAX} = Maximum duty cycle(0.89),

f_{SW} = Switching frequency,

ΔV_{IN} = Allowable input-voltage ripple.

Selection of Output Capacitor

Small ceramic X7R-grade capacitors are sufficient and recommended for output-voltage generation. The output capacitor has two functions. It provides smooth voltage and, stores sufficient energy to support the output voltage under load transient conditions and stabilizes the device's internal control loop. Usually the output capacitor is sized to support a step load of 50% of the maximum output current in the application, such that the output-voltage deviation is less than 3%. Required output capacitance can be calculated from the following equation:

$$C_{OUT} = \frac{30}{V_{OUT}}$$

where C_{OUT} is the output capacitance in μF and V_{OUT} is the output voltage. Derating of ceramic capacitors with DC-voltage must be considered while selecting the output capacitor.

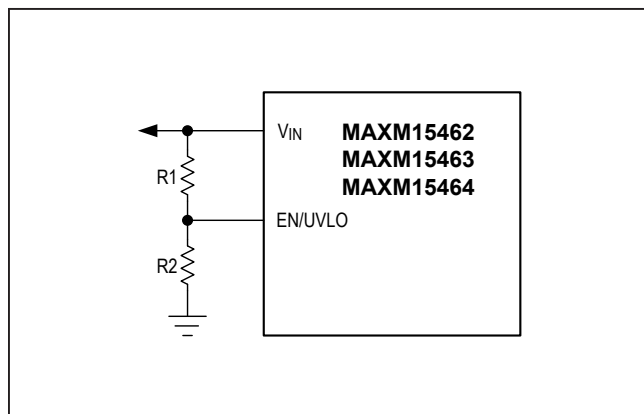

Figure 1. Adjustable EN/UVLO Network

Setting the Input Undervoltage-Lockout Level

The devices offer an adjustable input undervoltage lock-out level. Set the voltage at which the device turns on with a resistive voltage-divider connected from V_{IN} to GND (see Figure 1). Connect the center node of the divider to EN/UVLO.

Choose R1 to be 3.3M Ω (max), and then calculate R2 as follows:

$$R2 = \frac{R1 \times 1.215}{V_{INU} - 1.215}$$

where V_{INU} is the voltage at which the device is required to turn on.

If the EN/UVLO pin is driven from an external signal source, a series resistance of minimum 1k Ω is recommended to be placed between the signal source output and the EN/UVLO pin, to reduce voltage ringing on the line.

Output-Voltage Setting

The MAXM15462 output voltage can be programmed from 0.9V to 5V. Set the output voltage by connecting a resistor-divider from output to FB to GND (see Figure 2).

Choose R4 less than or equal to 75k Ω and calculate R3 with the following equation:

$$R3 = R4 \times \left(\frac{V_{OUT}}{0.9} - 1 \right)$$

Connect FB of MAXM15463 and MAXM15464 directly to V_{OUT} for feedback control.

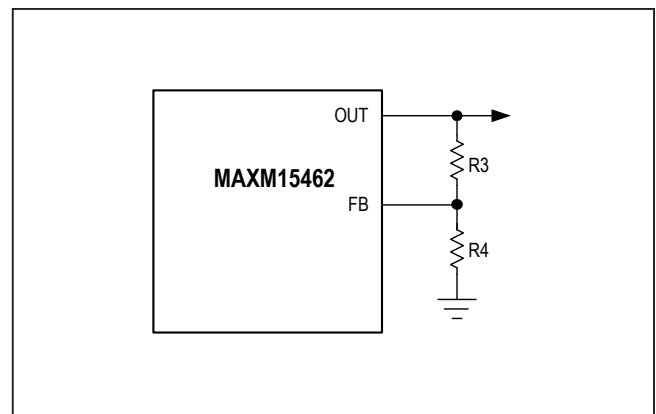

Figure 2. Setting the Output Voltage

Table 1. Selection of Components

PART NUMBER	V _{IN(MIN)} (V)	V _{IN(MAX)} (V)	V _{OUT*} (V)	C _{IN}	C _{OUT}	R3 (kΩ)	R4 (kΩ)
MAXM15462	4.5	12.5	0.9	1 x 1μF 0805 25V (Murata GR219R71E105KA88D)	1 x 47μF 1210 6.3V (Murata GRM32ER70J476KE20L)	SHORT	OPEN
	4.5	14	1	1 x 1μF 0805 25V (Murata GR219R71E105KA88D)	1 x 47μF 1210 6.3V (Murata GRM32ER70J476KE20L)	8.33	75
	4.5	17	1.2	1 x 1μF 0805 25V (Murata GR219R71E105KA88D)	1 x 47μF 1210 6.3V (Murata GRM32ER70J476KE20L)	25	75
	4.5	21.5	1.5	1 x 1μF 0805 25V (Murata GR219R71E105KA88D)	1 x 22μF 1206 6.3V (Murata GRM31CR70J226KE19L)	50	75
	4.5	25.5	1.8	1 x 1μF 0805 50V (Murata GRM21BR71105KA12L)	1 x 22μF 1206 6.3V (Murata GRM31CR70J226KE19L)	75	75
	4.5	36	2.5	1 x 1μF 0805 50V (Murata GRM21BR71105KA12L)	1 x 22μF 1206 6.3V (Murata GRM31CR70J226KE19L)	133	75
	5.5	42	3.3	1 x 1μF 0805 50V (Murata GRM21BR71105KA12L)	1 x 10μF 1206 6.3V (Murata GRM31CR70J106KA01L)	200	75
	12	42	5	1 x 1μF 0805 50V (Murata GRM21BR71105KA12L)	1 x 10μF 1206 6.3V (Murata GRM31CR70J106KA01L)	348	75
MAXM15463	5.5	42	3.3	1 x 1μF 0805 50V (Murata GRM21BR71105KA12L)	1 x 10μF 1206 6.3V (Murata GRM31CR70J106KA01L)	N/A	N/A
MAXM15464	12	42	5	1 x 1μF 0805 50V (Murata GRM21BR71105KA12L)	1 x 10μF 1206 6.3V (Murata GRM31CR70J106KA01L)	N/A	N/A

* The modules have a pulse skip algorithm that allows V_{OUT} to be regulated beyond the V_{IN(MAX)} specified in the above table, up to 42V.

Power Dissipation

The power dissipation inside the module leads to increase in the junction temperature of the MAXM15462/MAXM15463/MAXM15464. The power loss inside the module at full load can be estimated as follows:

$$P_{LOSS} = P_{OUT} \times \left[\frac{1}{\eta} - 1 \right]$$

Where η is the efficiency of the power module at the desired operating conditions. The junction temperature (T_J) of the module can be estimated at any given maximum ambient temperature (T_A) from the following equation:

$$T_J = T_A + [\theta_{JA} \times P_{LOSS}]$$

For the MAXM15462/MAXM15463/MAXM15464 evaluation board, the thermal resistance from junction-to-ambient (θ_{JA}) is 41.56°C/W. Operating the module at junction temperatures greater than +125°C degrades operating lifetimes. An EESIM model is available for the MAXM15462/MAXM15463/MAXM15464 to simulate efficiency and power loss for the desired operating conditions.

PCB Layout Guidelines

Use the following guidelines for good PCB layout:

- Keep the input capacitors as close as possible to the IN and GND pins.
- Keep the output capacitors as close as possible to the OUT and GND pins.
- Keep the resistive feedback dividers as close as possible to the FB pin.
- Keep the power traces and load connections short. Refer to the EV kit layout for first-pass success.

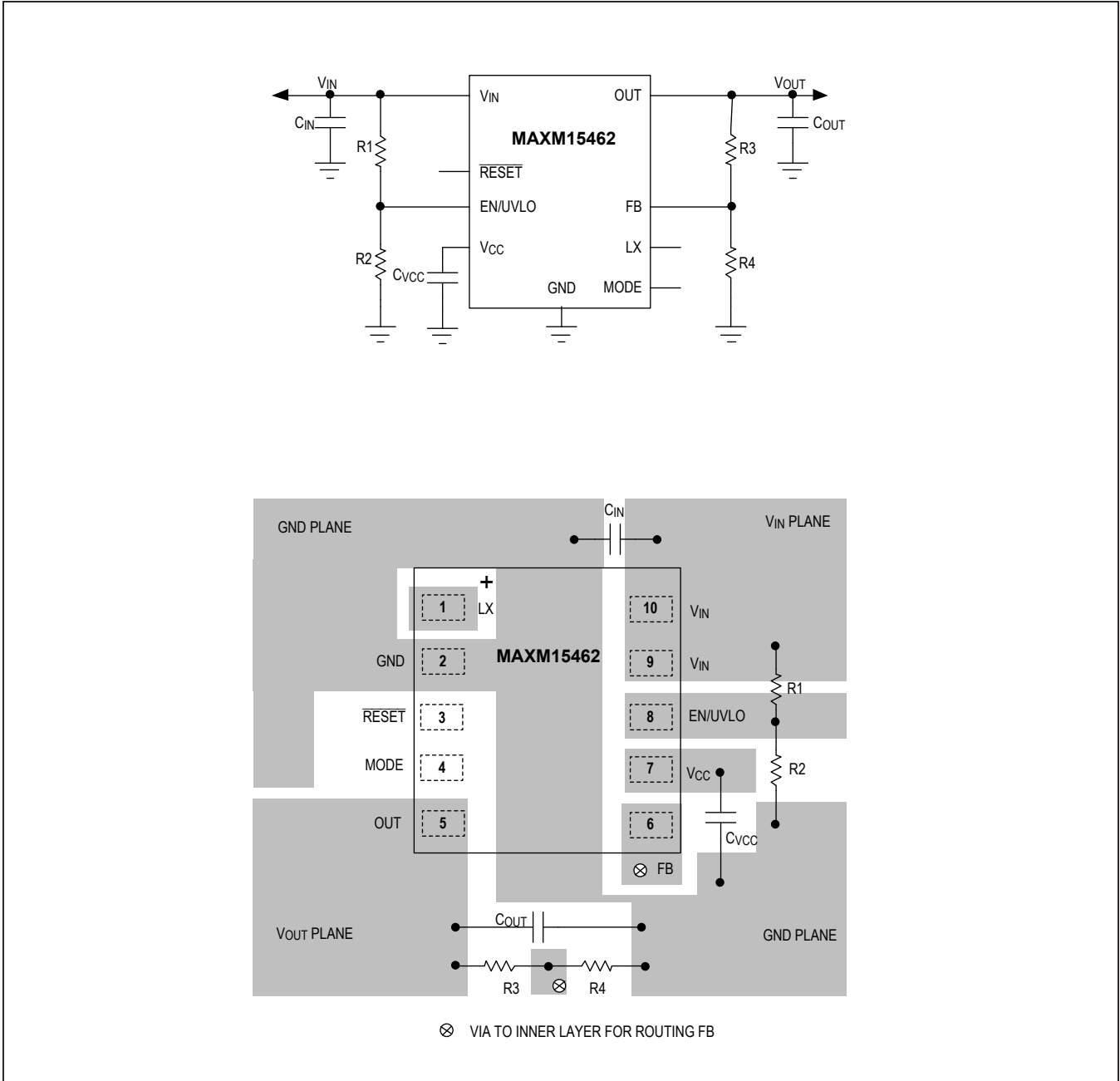

Figure 3. Adjustable Output Layout Guidelines

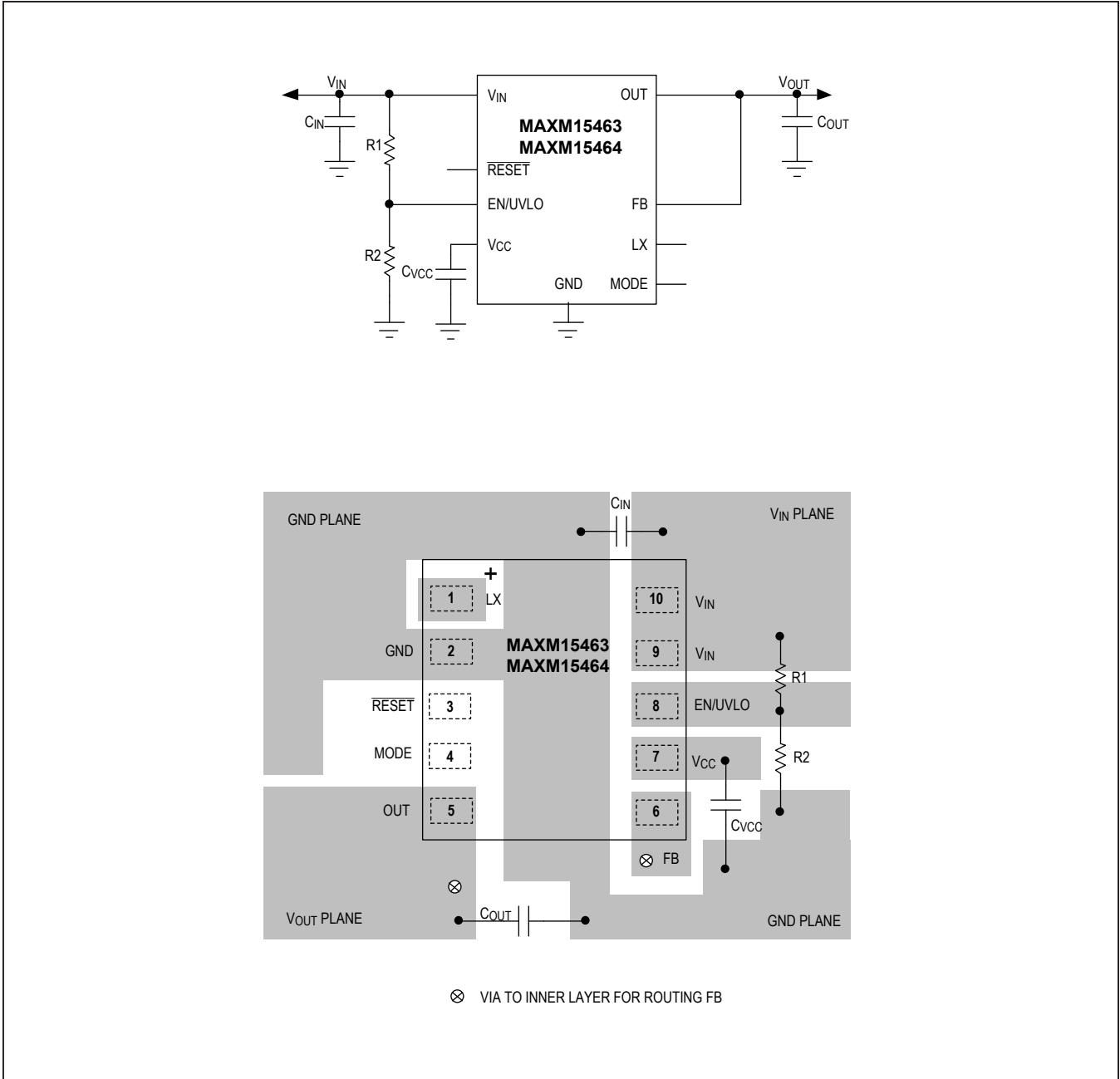
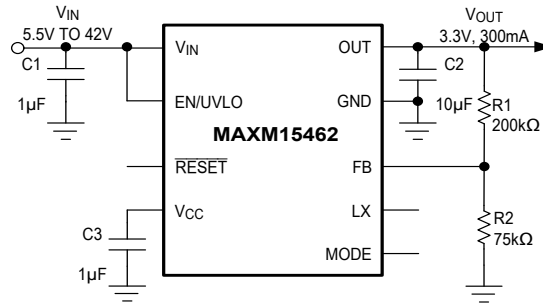

Figure 4. Fixed Output Layout Guidelines

Typical Application Circuits

Typical Application Circuit for Adjustable 3.3V Output



MODE = GND FOR PWM
 MODE = OPEN FOR PFM
 C1 = MURATA 1µF/X7R/50V/0805 (GRM21BR71H105KA12L)
 C2 = MURATA 10µF/X7R/6.3V/1206 (GRM31CR70J106KA01L)
 C3 = MURATA 1µF/X7R/6.3V/0603 (GRM188R70J105K)

Typical Application Circuit for Adjustable 2.5V output

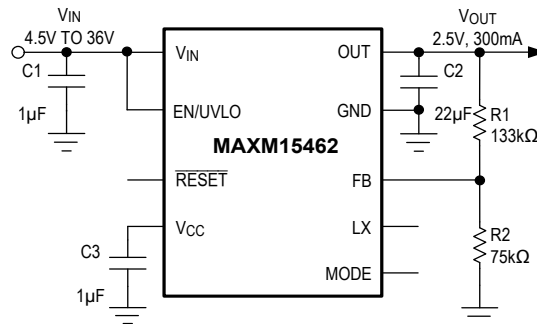

MODE = GND FOR PWM
 MODE = OPEN FOR PFM
 C1 = MURATA 1µF/X7R/50V/0805 (GRM21BR71H105KA12L)
 C2 = MURATA 22µF/X7R/6.3V/1206 (GRM31CR70J226KE19L)
 C3 = MURATA 1µF/X7R/6.3V/0603 (GRM188R70J105K)

Typical Application Circuits (continued)

Typical Application Circuit for Adjustable 1.5V output

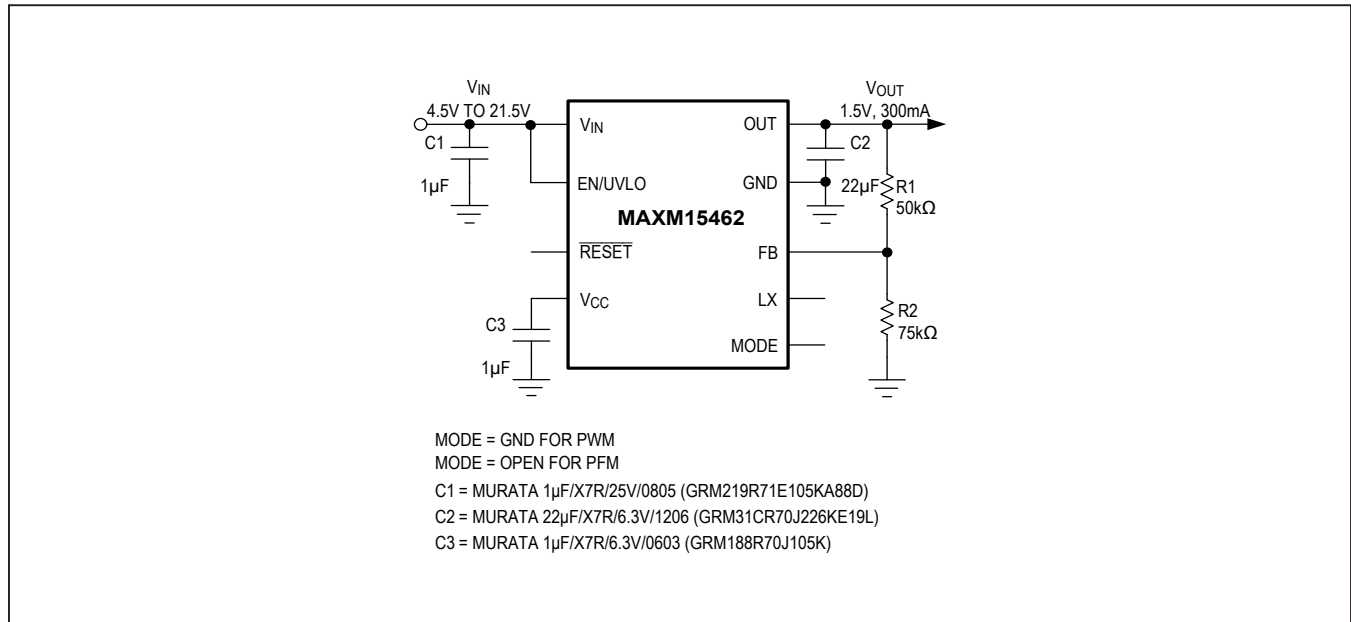

Typical Application Circuit for Fixed 3.3V output

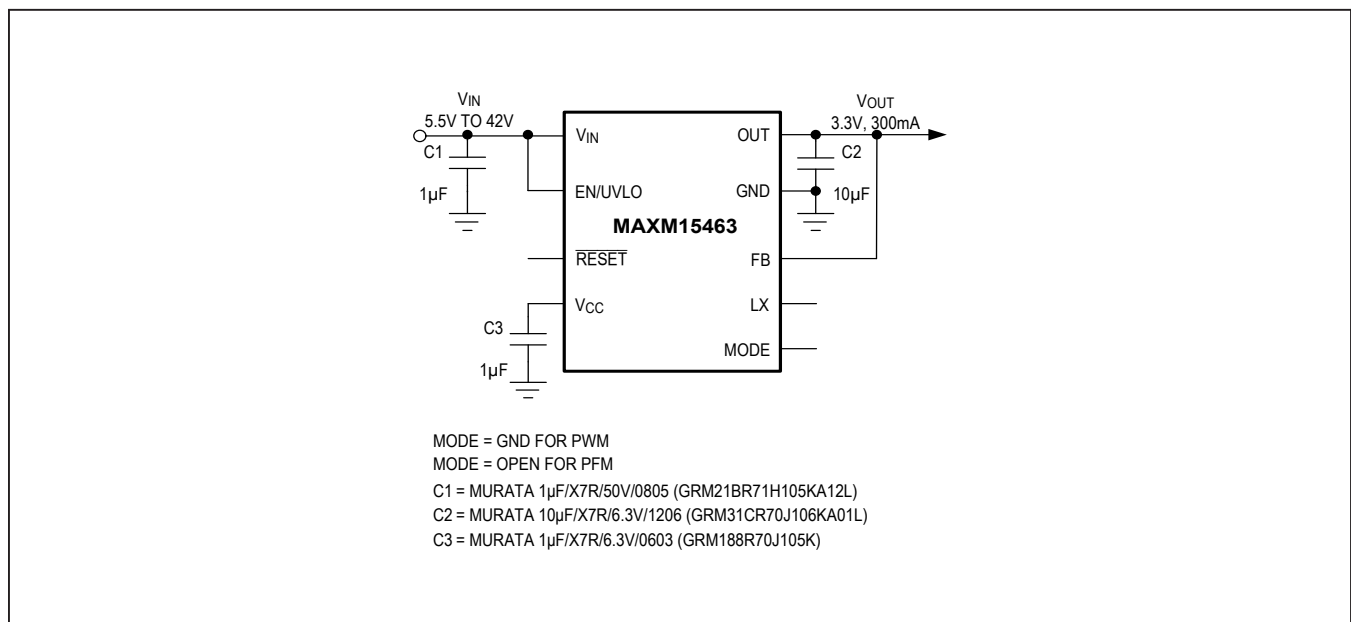

Typical Application Circuits (continued)

Typical Application Circuit for Fixed 5V Output

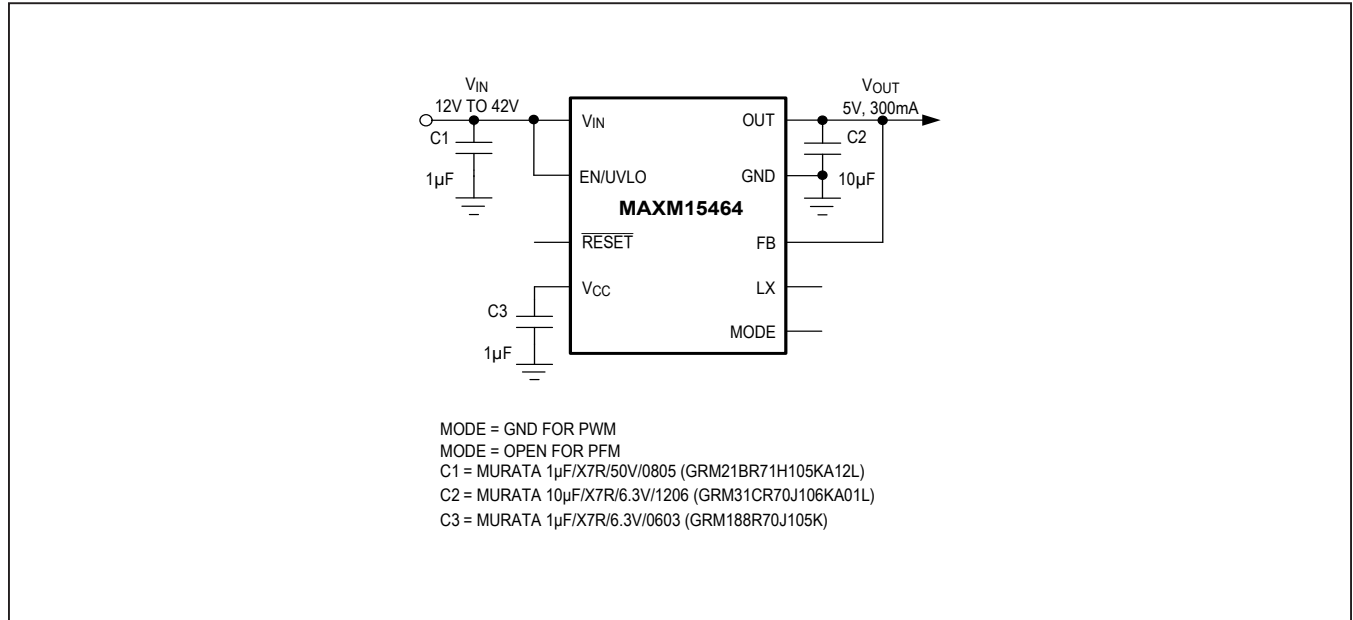

Ordering Information

PART NUMBER	TEMP RANGE	PIN-PACKAGE
MAXM15462AMB+	-40°C to +125°C	10-pin uSLIC
MAXM15462AMB+T	-40°C to +125°C	10-pin uSLIC
MAXM15463AMB+	-40°C to +125°C	10-pin uSLIC
MAXM15463AMB+T	-40°C to +125°C	10-pin uSLIC
MAXM15464AMB+	-40°C to +125°C	10-pin uSLIC
MAXM15464AMB+T	-40°C to +125°C	10-pin uSLIC

+ Denotes a lead(Pb)-free/RoHS-compliant package.

T Denotes tape-and-reel.

Revision History

REVISION NUMBER	REVISION DATE	DESCRIPTION	PAGES CHANGED
0	10/17	Initial release	—
0.1		Added trademark information for uSLIC	1–2, 18
1	3/18	Updated <i>General Description, Benefits and Features, Applications, Typical Application Circuit, and Absolute Maximum Ratings</i> sections	1, 2
2	3/18	Updated <i>General Description</i> section.	1
3	7/18	Updated the <i>General Description, Benefits and Features, Detailed Description, RESET Output, Startup into a Prebiased Output, Overcurrent Protection (OCP)/Hiccup Mode, Input-Voltage Range, Output-Voltage Setting and Power Dissipation</i> sections; updated the <i>Electrical Characteristics, Pin Description and Ordering Information</i> tables, Table 1, and the <i>Typical Application Circuit 5V on page 1</i> ; added the <i>Typical Application Circuit 2.5V on page 1, Figure 4, Typical Application Circuit Fixed 3.3V and Fixed 5V</i> , and Table A; replaced TOC01-TOC89, <i>Pin Configuration</i> , and Figure 1.	1–19
4	8/18	Updated the <i>Typical Application Circuit 2.5V, Electrical Characteristics, Figure 3, and Figure 4</i> .	1, 3, 20-21

For pricing, delivery, and ordering information, please visit Maxim Integrated's online storefront at <https://www.maximintegrated.com/en/storefront/storefront.html>.

Maxim Integrated cannot assume responsibility for use of any circuitry other than circuitry entirely embodied in a Maxim Integrated product. No circuit patent licenses are implied. Maxim Integrated reserves the right to change the circuitry and specifications without notice at any time. The parametric values (min and max limits) shown in the *Electrical Characteristics* table are guaranteed. Other parametric values quoted in this data sheet are provided for guidance.