

REVISIONS					
REV	ECO	DESCRIPTION	DATE	BY	APPR
A1	-	RELEASE NUMBER	27/JUL/2021	LOUIE	TOMMY

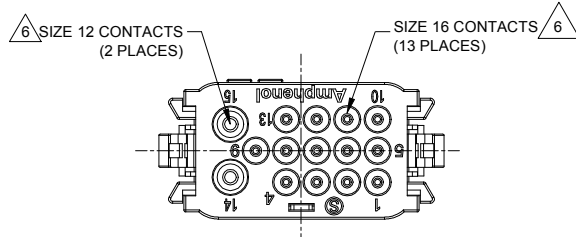
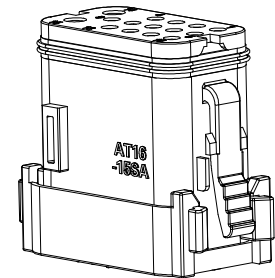
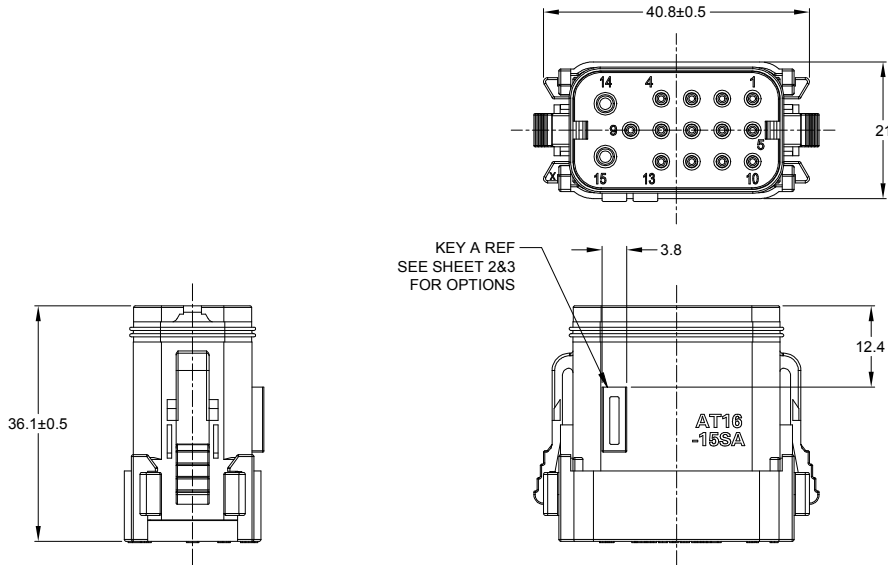

△ CONTACT SIZE AND REAR SEAL WIRE RANGE

CONTACT SIZE	MIN. INSUL O.D.	MAX. INSUL O.D.	TYPICAL WIRE RANGE
12	2.46 mm (.097 in)	4.01 mm (.158 in)	10 - 14 AWG (3.0-2.0)
16	1.35 mm (.053 in)	3.05 mm (.120 in)	14 - 20 AWG (2.0-0.5)

NOTES: UNLESS OTHERWISE SPECIFIED

- MATERIAL:**
HOUSING: THERMOPLASTIC; COLOR: SEE CHART
END CAP: THERMOPLASTIC; COLOR: BLACK
SEALS: SILICONE RUBBER; COLOR: RED (FRONT SEAL), GREEN(REAR SEAL)
- MODIFICATIONS:** END CAP, REDUCED DIAMETER SEAL.
- SPECIFICATIONS:**
 - CURRENT RATING: SIZE 16, 13 AMPS; SIZE 12, 25 AMPS.
 - OPERATING TEMPERATURE: -55°C TO +125°C
 - DIELECTRIC WITHSTANDING VOLTAGE: LESS THAN 2 MILLIAMPS CURRENT LEAKAGE @ 1500 VOLTS AC.
 - INSULATION RESISTANCE: 1000 MEGOHMS MIN @ 25°C.
 - MOISTURE RESISTANCE: IP68(1M OF WATER FOR A PERIOD OF 24 HOURS , MATED CONDITION) IP69K(MATED CONDITION)
 - MATING CYCLE DURABILITY: 100 CYCLES
 - RoHS COMPLIANT
- MATING PART:** AT16-15PX-* RECEPTACLES
(X = A,B,C,D,E KEYS; * = MODIFICATIONS AND COLORS)
- ALL DIMENSIONS ARE FOR REFERENCE USE ONLY.**

TITLE: 15 POSITION PLUG, SOCKET,AT SERIES
DWG NO: AT16-15SX-XXXX
REV: A1
SH: 1
OF: 3

SEE PIN CHART		REF: DT16-15SA-K003, DT16-15SB-K003, DT16-15SC-K003, DT16-15SD-K003, DT16-15SE-K003	
PART NUMBER		DESCRIPTION	
QUANTITY	MATERIALS LIST		
UNLESS OTHERWISE SPECIFIED 1) All dimensions are in metric(mm). 2) Tolerances are as follows: 1 PL DEC ±0.30 Fractions ±1/64 2 PL DEC ±0.15 Angles ±1° 3 PL DEC ±0.08 3) Note reference = △	SIGNATURES	DATE	SINE Systems Corporation A Subsidiary of Amphenol Corporation 44724 Morley Drive Clinton Township, MI 48036 15 POSITION PLUG, SOCKET,AT SERIES
	DRAWN: LOUIE YN	27/JUL/2021	
	CHECKED: ORON LI	28/JUL/2021	
	ENGINEER: TOMMY XIE	28/JUL/2021	
MATERIAL SPECIFICATIONS:		CUSTOMER:	
PROCESS SPECIFICATIONS:		THIS DRAWING IS SUPPLIED FOR INFORMATION ONLY. DESIGN FEATURES, SPECIFICATIONS AND PERFORMANCE DATA SHOWN HEREON ARE THE PROPERTY OF THE AMPHENOL CORPORATION. NO RIGHTS OF REPRODUCTION ARE IMPLIED. ALL DIMENSIONS ARE SUBJECT TO NORMAL MANUFACTURING VARIATIONS.	
NEXT ASSY:	SIZE B C- FSCM NO. DWG NO. AT16-15SX-XXXX REVISION A1 SCALE: NONE SHEET 1 OF 3		

REVISIONS					
REV	ECO	DESCRIPTION	DATE	BY	APPR
A1	-	RELEASE NUMBER	27/JUL/2021	LOUIE	TOMMY

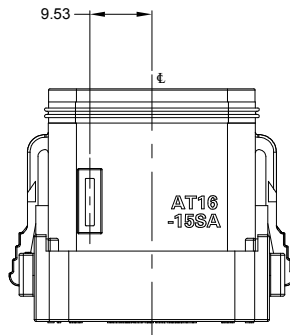

KEY-A CONFIGURATION	
PART NUMBER	COLOR OF HOUSING
AT16-15SA-K003	BLACK
AT16-15SA-EK02	GRAY

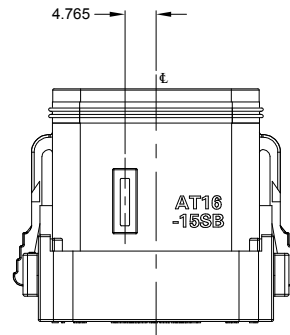

KEY-B CONFIGURATION	
PART NUMBER	COLOR OF HOUSING
AT16-15SB-K003	BLACK

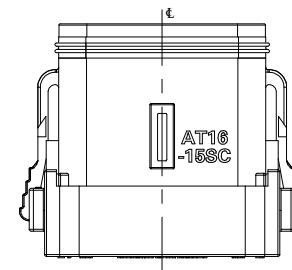

KEY-C CONFIGURATION	
PART NUMBER	COLOR OF HOUSING
AT16-15SC-K003	BLACK
AT16-15SC-EK02	GRAY

TITLE: 15 POSITION PLUG, SOCKET, AT SERIES
 DWG NO: AT16-15SX-XXXX
 REV: A1
 SH: 2
 OF: 3

SEE PN CHART		DESCRIPTION		ITEM
QUANTITY	PART NUMBER			
MATERIALS LIST				
UNLESS OTHERWISE SPECIFIED 1) All dimensions are in metric(mm). 2) Tolerances are as follows: 1 PL DEC ±0.30 Fractions ±1/64 2 PL DEC ±0.15 Angles ±1° 3 PL DEC ±0.08 3) Note reference =		SIGNATURES DRAWN: LOUIE YIN 27JUL2021 CHECKED: ORON LI 28JUL2021 ENGINEER: APPROVAL: TOMMY XIE 28JUL2021 CUSTOMER:		SINE Systems Corporation A Subsidiary of Amphenol Corporation 44724 Morley Drive Clinton Township, MI 48036
MATERIAL SPECIFICATIONS: PROCESS SPECIFICATIONS: NEXT ASSY:		THIS DRAWING IS SUPPLIED FOR INFORMATION ONLY. DESIGN FEATURES, SPECIFICATIONS AND PERFORMANCE DATA SHOWN HEREON ARE THE PROPERTY OF THE AMPHENOL CORPORATION. NO RIGHTS OF REPRODUCTION ARE IMPLIED. ALL DIMENSIONS ARE SUBJECT TO NORMAL MANUFACTURING VARIATIONS.		
		SIZE B C-	FSCM NO. AT16-15SX-XXXX	REVISION A1
		SCALE: NONE	SHEET 2 OF 3	

REVISIONS					
REV	ECO	DESCRIPTION	DATE	BY	APPR
A1	-	RELEASE NUMBER	27/JUL/2021	LOUIE	TOMMY

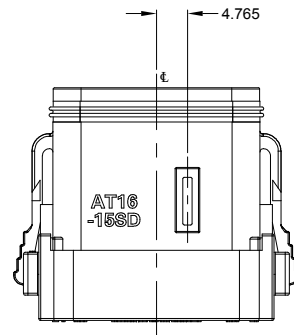

KEY-D CONFIGURATION	
PART NUMBER	COLOR OF HOUSING
AT16-15SD-K003	BLACK
AT16-15SD-EK02	GRAY

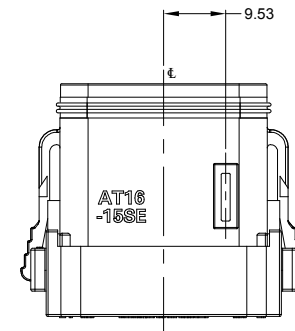



KEY-E CONFIGURATION	
PART NUMBER	COLOR OF HOUSING
AT16-15SE-K003	BLACK
AT16-15SE-EK02	GRAY



TITLE: 15 POSITION PLUG, SOCKET, AT SERIES
 DWG NO: AT16-15SX-XXXX
 REV: A1
 SH: 3
 OF: 3

SEE P/N CHART		PART NUMBER		DESCRIPTION		ITEM
QUANTITY		MATERIALS LIST				
UNLESS OTHERWISE SPECIFIED 1) All dimensions are in metric (mm). 2) Tolerances are as follows: 1 PL DEC ±0.30 2 PL DEC ±0.15 3 PL DEC ±0.08 3) Note reference =		SIGNATURES DRAWN: LOUIE YIN CHECKED: ORON LI ENGINEER: APPROVAL: TOMMY XIE		DATE 27 JUL 2021 28 JUL 2021 28 JUL 2021		SINE Systems Corporation A Subsidiary of Amphenol Corporation 44724 Morley Drive Clinton Township, MI 48036
MATERIAL SPECIFICATIONS:		CUSTOMER:		15 POSITION PLUG, SOCKET, AT SERIES		
PROCESS SPECIFICATIONS:		THIS DRAWING IS SUPPLIED FOR INFORMATION ONLY. DESIGN FEATURES, SPECIFICATIONS AND PERFORMANCE DATA SHOWN HEREON ARE THE PROPERTY OF THE AMPHENOL CORPORATION. NO RIGHTS OF REPRODUCTION ARE IMPLIED. ALL DIMENSIONS ARE SUBJECT TO NORMAL MANUFACTURING VARIATIONS.		SIZE FSCM NO. DWG NO. B C- AT16-15SX-XXXX		REVISION A1
NEXT ASSY:		SCALE: NONE		SHEET 3 OF 3		



AT Series™ - Contact Size 16 Options

Machined Contacts, Sockets & Pins				
Part Number	Description	Size	AWG	Type
AT60-215-1631	Male Contact - Pin, Gold-plated	16	14	Machined
AT62-209-1631	Female Contact - Socket, Gold-plated	16	14	Machined
AT60-215-16141	Male Contact - Pin, Nickel-plated	16	14	Machined
AT62-209-16141	Female Contact - Socket, Nickel-plated	16	14	Machined
AT60-202-1631	Male Contact - Pin, Gold-plated	16	16-20	Machined
AT62-201-1631	Female Contact - Socket, Gold-plated	16	16-20	Machined
AT60-202-16141	Male Contact - Pin, Nickel-plated	16	16-20	Machined
AT62-201-16141	Female Contact - Socket, Nickel-plated	16	16-20	Machined
AT60-202-1631-22	Male Contact - Pin, Gold-plated	16	22-24	Machined
AT62-201-1631-22	Female Contact - Socket, Gold-plated	16	22-24	Machined
AT60-202-16141-22	Male Contact - Pin, Nickel-plated	16	22-24	Machined
AT62-201-16141-22	Female Contact - Socket, Nickel-plated	16	22-24	Machined

Tooling - Machined Contacts		
Part	Part Number	Description
	CA-5D12	Universal Hand Crimp Tool, Size 12/16/20 (Machined contacts only)
	CA-5E12	Pneumatic Crimp Tool, Size 12/16/20 (Machined contacts only)

Contact Removal Tools		
Part	Part Number	Description
	ATRT-100	Used for removal of contacts for A Series™ products
	AT11-310-1605	Contact Removal Tool, Plastic, Size 16
	A114017	Sealing Plug, Size 16, White

Stamped & Formed Contacts, Sockets & Pins				
Part Number	Description	Size	AWG	Type
AT60-14-0144	Male Contact - Pin, Gold-plated	16	14-16	Stamped & Formed
AT62-14-0144	Female Contact - Socket, Gold-plated	16	14-16	Stamped & Formed
AT60-14-0122	Male Contact - Pin, Nickel-plated	16	14-16	Stamped & Formed
AT62-14-0122	Female Contact - Socket, Nickel-plated	16	14-16	Stamped & Formed
AT60-16-0144	Male Contact - Pin, Gold-plated	16	16-18	Stamped & Formed
AT62-16-0144	Female Contact - Socket, Gold-plated	16	16-18	Stamped & Formed
AT60-16-0122	Male Contact - Pin, Nickel-plated	16	16-18	Stamped & Formed
AT62-16-0122	Female Contact - Socket, Nickel-plated	16	16-18	Stamped & Formed
AT60-16-0644	Male Contact - Pin, Gold-plated	16	18-20	Stamped & Formed
AT62-16-0644	Female Contact - Socket, Gold-plated	16	18-20	Stamped & Formed
AT60-16-0622	Male Contact - Pin, Nickel-plated	16	18-20	Stamped & Formed
AT62-16-0622	Female Contact - Socket, Nickel-plated	16	18-20	Stamped & Formed
AT60-16-0844	Male Contact - Pin, Gold-plated	16	20-22	Stamped & Formed
AT62-16-0844	Female Contact - Socket, Gold-plated	16	20-22	Stamped & Formed
AT60-16-0822	Male Contact - Pin, Nickel-plated	16	20-22	Stamped & Formed
AT62-16-0822	Female Contact - Socket, Nickel-plated	16	20-22	Stamped & Formed



Tooling - Stamped & Formed Contacts		
Part	Part Number	Description
	MF3-3950	Crimp Die - Size 16, 18-20AWG (S&F contacts only)
	MF3-3953	Crimp Die - Size 16, 16-18AWG (S&F contacts only)
	MF3-3975	Crimp Die - Size 16, 14-16AWG (S&F contacts only)
	MF3-3990	Crimp Die - Size 16, 20-22AWG (S&F contacts only)
	ATT-16-00	Hand Crimp Tool - Size 16, 14-16AWG (S&F contacts only)
	ATT-16-01	Hand Crimp Tool - Size 16, 18-20AWG (S&F contacts only)
	ATT-1612-03	Hand Crimp Tool - Size 16, 20-22AWG (S&F contacts only)



Amphenol Sine Systems
 44724 Morley Drive
 Clinton Township, MI 48036 USA
www.amphenol-sine.com
 09/2021

ATP Series™ - Contact Size 12 Options



Machined Contacts, Sockets & Pins				
Part Number	Description	Size	AWG	Type
AT60-204-12141-10	Male Contact - Pin, Nickel-plated	12	10-12	Machined
AT62-203-12141-10	Female Contact - Socket, Nickel-plated	12	10-12	Machined
AT60-220-1231	Male Contact - Pin, Gold-plated	12	12-14	Machined
AT62-210-1231	Female Contact - Socket, Gold-plated	12	12-14	Machined
AT60-204-12141	Male Contact - Pin, Nickel-plated	12	12-14	Machined
AT62-203-12141	Female Contact - Socket, Nickel-plated	12	12-14	Machined

DiagnosticGrade™ Machined Contacts, Sockets & Pins				
• Smaller AWG for Diagnostic Applications • Gold-plated • Increased Mating Cycles • Cost-effective				
Part Number	Description	Size	AWG	Type
65-54749	Male Contact - DiagnosticGrade™, Pin, Gold-plated	12	20	Machined
AT62-210-1231-1820	Female Contact - DiagnosticGrade™, Socket, Gold-plated	12	20	Machined

Tooling - Machined Contacts		
Part	Part Number	Description
	CA-5D12	Universal Hand Crimp Tool, Size 12/16/20 (Machined contacts only)
	CA-5E12	Pneumatic Crimp Tool, Size 12/16/20 (Machined contacts only)

Contact Removal Tools		
Part	Part Number	Description
	ATRT-100	Used for removal of contacts for A Series™ products
	AT11-337-1205	Contact Removal Tool, Plastic, Size 12
	A114017	Sealing Plug, Size 12, White

Stamped & Formed Contacts, Sockets & Pins				
Part Number	Description	Size	AWG	Type
AT60-12-0244	Male Contact - Pin, Gold-plated	12	10-12	Stamped & Formed
AT62-12-0244	Female Contact - Socket, Gold-plated	12	10-12	Stamped & Formed
AT60-12-0222	Male Contact - Pin, Nickel-plated	12	10-12	Stamped & Formed
AT62-12-0222	Female Contact - Socket, Nickel-plated	12	10-12	Stamped & Formed
AT60-12-0144	Male Contact - Pin, Gold-plated	12	12-14	Stamped & Formed
AT62-12-0144	Female Contact - Socket, Gold-plated	12	12-14	Stamped & Formed
AT60-12-0166	Male Contact - Pin, Nickel-plated	12	12-14	Stamped & Formed
AT62-12-0166	Female Contact - Socket, Nickel-plated	12	12-14	Stamped & Formed

Tooling - Stamped & Formed Contacts		
Part	Part Number	Description
	MXF-3973	Crimp Die - Size 12 (S&F contacts only)
	MXF-3985	Crimp Die - Size 12 (S&F contacts only) 10-12AWG -02XX Series
	ATT-12-00	Hand Crimp Tool - Size 12, 12AWG (S&F contacts only)

Amphenol Sine Systems
 44724 Morley Drive
 Clinton Township, MI 48036 USA
www.amphenol-sine.com
 09/2021