



SPECIFICATIONS

Model	Stroke mm	Max Energy Absorption J(kgf·m)	Max Equiv. Mass kg(kgf)	Range of Impact Rate m/s	Orifice Type
FA-F0806-S	6	1.4(0.14)	15(15)	0.3~2	Single-orifice type

COMMON SPECIFICATIONS

Max Drag N(kgf)	Max Cycle Rate cycle/min	Max Energy Absorption per min. J/min(kgf·m/min)	Extension Force N(kgf)	Operating Temp. C°	Mass g
670(68.3)	45	36.7(3.74)	9 (0.92) or lower	-5~70	13.8

OVERVIEW

Adjustable Type

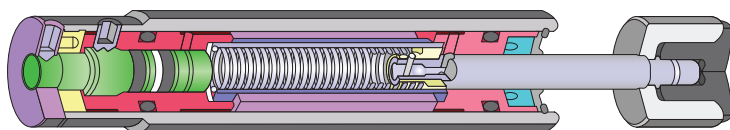

In a normal absorber, adhering liquid is pushed inside with each stroke. This can block the accumulator and the flow of oil, ultimately preventing the rod from inserting or causing other trouble.

Anti-coolant Specifications

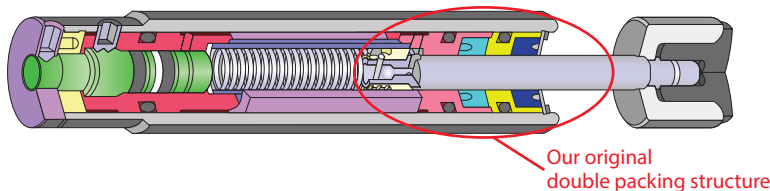

In the anti-coolant specifications, two internal U-packings are used (double packing structure) to form a wiper seal structure that prevents the adhering liquid from being pushed inside.

SPECIFICATIONS

- The specifications are identical with the standard models for each model.

PRECAUTIONS FOR USE

- This product may not offer sufficient durability, depending on the liquid you use or its quantity. It is recommended to perform tests for adequacy in advance.
- When the piston rod is not pressed all the way down to the stroke end during operation, stop use and exchange the product for the product life. If the product is used continuously, damage of the product may be caused.
- This product has a unique packing structure. Because of this, using this product in places where the piston rod remains dry may cause the inside oil to leak early on in its product life.
- If you use the optional parts, please contact our sales department.

OPTIONAL PARTS

Eccentric angle adaptor OP-010MB

- Screw the eccentric angle adaptor into the main unit until the cap for the eccentric angle and the piston rod form a tight connection. While maintaining this position, fasten the main unit's nut until it is secured.
- Use the eccentric angle adaptor when the eccentric angle is 2.5° or larger.
- The main unit can also be used as a stopper.
- Use it with FA-E0806-S.
- The maximum operating eccentric angle with an eccentric angle adaptor is $\pm 10^\circ$.
- The maximum inclination angle using an inclination angle adaptor is $\pm 10^\circ$
- The caps and the guides for inclined use are not unbundled.

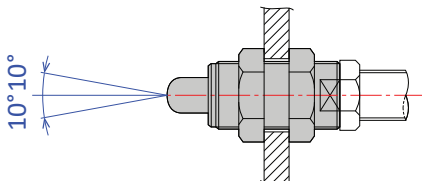
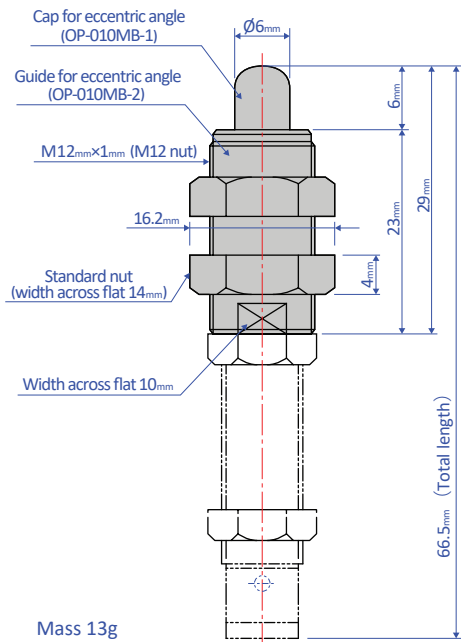

Note: Material of cap for eccentric angle: POM

Stopper nut OP-020SB

- Adjust so that it stops 1 mm before the stroke end, and fasten with the main unit's nut until secured.

OP-020SB-S
(without cap)

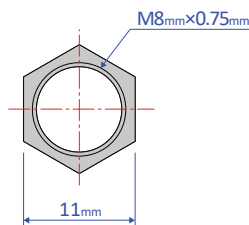
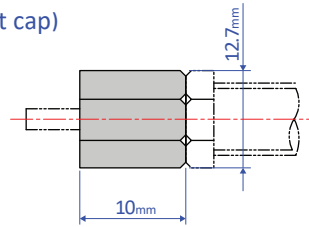

Mass 5g

OP-020SB-C
(with cap)

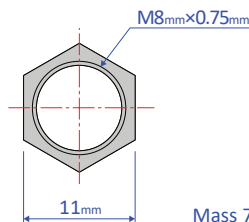
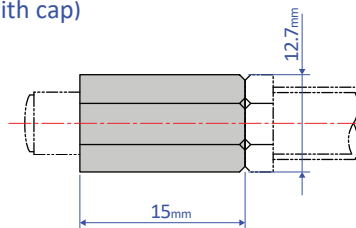

Mass 7g

Note: When attaching, make sure that the side without a bearing chamfer is the impact surface.

Standard nuts are sold separately as well - M08 Nut

Square flange OP-040SB

- Once the attachment site is determined, use the main unit's nut to securely fasten in place.

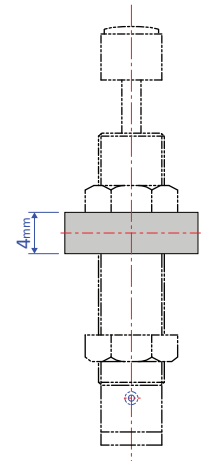
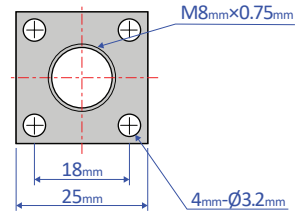

Mass 17g