



User Manual
Gateway PROFINET IRT Slave

Table of Contents

1	General Information	3
1.1	Disclaimer	3
1.2	Notes Regarding this User Manual	3
1.3	Validity.....	3
1.4	Limitation of Liability.....	3
1.5	Customer Service.....	4
2	Safe Use	5
2.1	Intended Use.....	5
2.2	User.....	5
2.3	Symbols	5
2.4	Important safety instructions	6
2.5	Environmental Conditions	6
2.6	Data Safety	7
3	Overview	8
3.1	Functionality	8
3.2	Control Elements.....	9
3.3	Status LEDs	12
4	Installation	13
4.1	Preparations for Inteference-free Operation	13
4.2	Requirements.....	14
4.3	Connecting Gateway Components	15
4.4	Installing a Gateway in the Control Cabinet.....	16
4.5	Connecting a Gateway to the Fieldbus	16
4.6	Connecting the Power Supply.....	17
5	Configuration.....	18
5.1	Supported Size of Process Data	18
5.2	Setting Station Name	18
5.3	Exchanging Data Cyclically.....	18
5.4	Exchanging Data Acyclically (Records)	21
5.4.1	I&M Data	22
5.4.2	Diagnosis Alarm.....	23
6	Integrated Servers.....	24
6.1	FTP-Server.....	24
6.2	Webserver.....	24
6.3	Firmware Update.....	25
7	Technical Data.....	36

1 General Information

1.1 Disclaimer

© 2022 KUNBUS GmbH, Denkendorf (Germany)

The contents of this document have been prepared by KUNBUS GmbH with the utmost care. Due to technical developments, KUNBUS GmbH reserves the right to change or replace the contents of this document without prior notice. You can always obtain the current version of the user manual on our homepage: www.kunbus.de

KUNBUS GmbH shall be liable exclusively to the extent specified in General Terms and Conditions (www.kunbus.de/agb.html).

The contents published in this document are protected by copyright. Any reproduction or use for the user's in-house requirements is permitted. Reproduction or use for other purposes is not permitted without the express, written consent of KUNBUS GmbH. Contraventions shall result in compensation for damages.

Trademark Protection

KUNBUS is a registered trademark of KUNBUS GmbH

Windows® and Microsoft® are registered trademarks of Microsoft Corp.

KUNBUS GmbH
Heerweg 15 C
73770 Denkendorf
Germany
www.kunbus.com

1.2 Notes Regarding this User Manual

This user manual provides important technical information that will enable you as a user to integrate the Gateways into your applications and systems efficiently, safely and conveniently. It is intended for trained, qualified personnel, whose sound knowledge in the field of electronic circuits and expertise of PROFINET is assumed.

As an integral part of the product, the information provided here should be kept and made available to the user.

1.3 Validity

This document describes the application of the KUNBUS Gateway Module with the product number:

- PR100074, release 05

1.4 Limitation of Liability

Warranty and liability claims will lapse, if:

- the product has been used incorrectly,
- the product is damaged due to non-observance of the operating manual,

- damage is caused by inadequately qualified personnel,
- damage is caused by technical modification to the product (e.g. soldering).

1.5 Customer Service

If you have any questions or suggestions concerning this product, please do not hesitate to contact us:

KUNBUS GmbH
Heerweg 15 C
73770 Denkendorf
Germany

support@kunbus.com
www.kunbus.com

2 Safe Use

2.1 Intended Use

The modular gateway component is part of a gateway that can be combined with another modular gateway component or a RevPi Core/Connect from KUNBUS as required.

The modular gateway component is designed to forward data from a specific protocol to a controller or other gateway component.

No other purpose is intended. If you do not use the device as intended, damage to property and personal injury may result.

2.2 User

The Gateway may only be assembled, installed and put into operation by trained, qualified personnel. Before assembly, it is absolutely essential that this documentation has been read carefully and understood. Expertise in the following fields is assumed:

- electronic circuits,
- Basic knowledge of PROFINET,
- work in electrostatic protected areas,
- locally applicable rules and regulations for occupational safety.

2.3 Symbols

The symbols used have the following meaning:

DANGER

Danger

Always observe this information!

There is a safety hazard that can lead to serious injuries and death.

CAUTION

Caution

There is a safety hazard that can result in minor injuries and material damage.

NOTICE

Note

There is a safety hazard that can result in material damage.

2.4 Important safety instructions

⚠ DANGER

Danger of explosion

The modular Gateway component do not meet the requirements of the ATEX directive. Therefore, they are not suitable for use in potentially explosive environments.

- a) Do not use the modular Gateway component in potentially explosive environments.

⚠ CAUTION

Electric shock

Switch off all voltages before assembly/disassembly.

- a) Failure to observe this warning may result in personal injury.

⚠ CAUTION

The devices are „open equipment“ according to the Standard UL61010-2-201.

To fulfill requirements for safe operation with regard to mechanical stability, flame retardation, stability, and protection against contact, the following alternative types of installation are specified:

- a) Installation in a suitable cabinet.
- b) Installation in a suitable enclosure.
- c) Installation in a suitable equipped, enclosed control room.

NOTICE

Incorrect connection of the power supply

Using an unsuitable power supply can destroy your modules and connected devices.

- a) Use a power supply in the approved area for the base modules. The values for this can be found in the technical data of your base module.

2.5 Environmental Conditions

Operate the device only in an environment that corresponds to the operating conditions in order to prevent damage.

Suitable environmental conditions are:

Operating temperature	-20 °C up to +55 °C
Humidity	93% (non-condensing)

NOTICE

This device is designed for indoor use only.

If you use the device outdoors, it may be destroyed.

- a) Use the device indoors only.

2.6 Data Safety

Please note that the Gateway is not suitable for use in unprotected networks (e.g. the Internet).

Operate the Gateway a secured network:

- a) Seal off your network so that no direct access via the Internet is permitted.
- b) Immediately change the default password for the web server. Select a secure new password. You can find current information on this at https://www.bsi.bund.de/EN/Home/home_node.html.
- c) Check our website regularly for the latest software security alerts and updates for your product. Install the security updates provided by us.

If you do not follow these instructions, it is possible that your module data may be manipulated.

3 Overview

3.1 Functionality

The KUNBUS Gateway is a protocol converter. It allows communication between networks with different protocols.

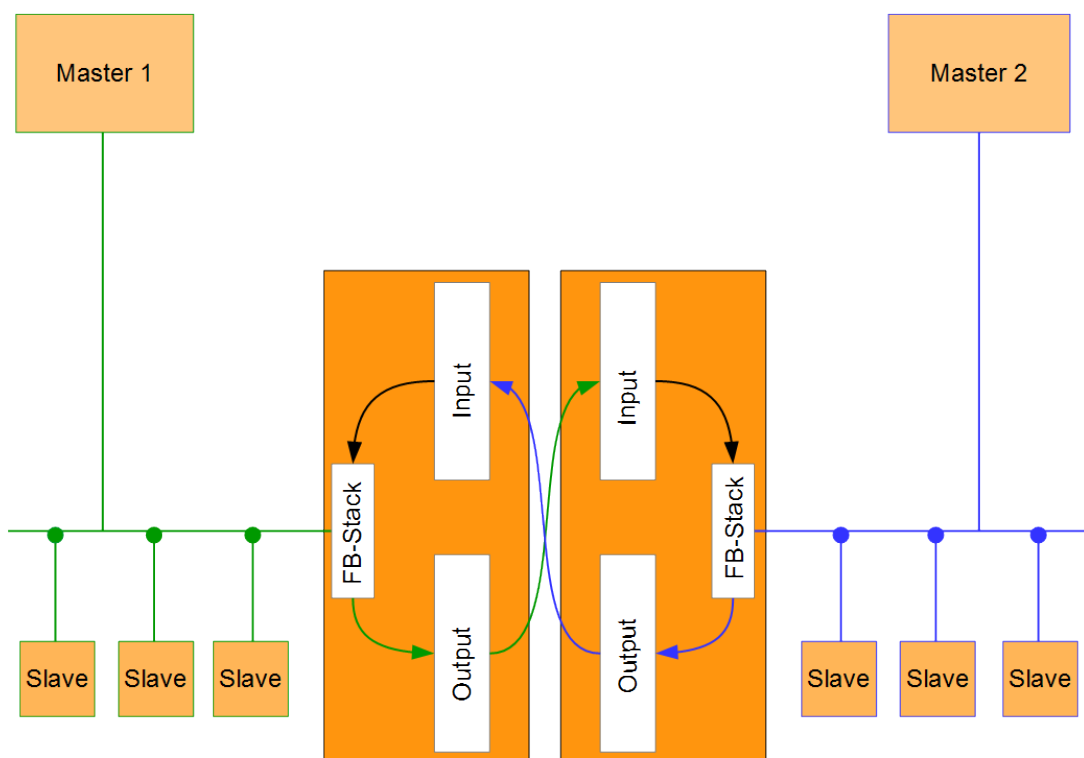

Illustration 1: Functionality as a slave

A Gateway consists of 2 gateway components that master one specific protocol each. You can combine these gateway components as you wish. This design offers you a high degree of flexibility, since you can exchange the individual gateway components at any time. The following gateway components are currently available as slaves:

- CANopen
- DeviceNet
- EtherCAT
- EtherNet/IP
- Modbus RTU
- Modbus TCP
- POWERLINK
- PROFIBUS
- PROFINET
- Sercos III

The gateway component for DMX can be operated as a master or slave.

In addition, you can combine the Gateway component with the RevPi Core and the RevPi Connect.

3.2 Control Elements

Front view

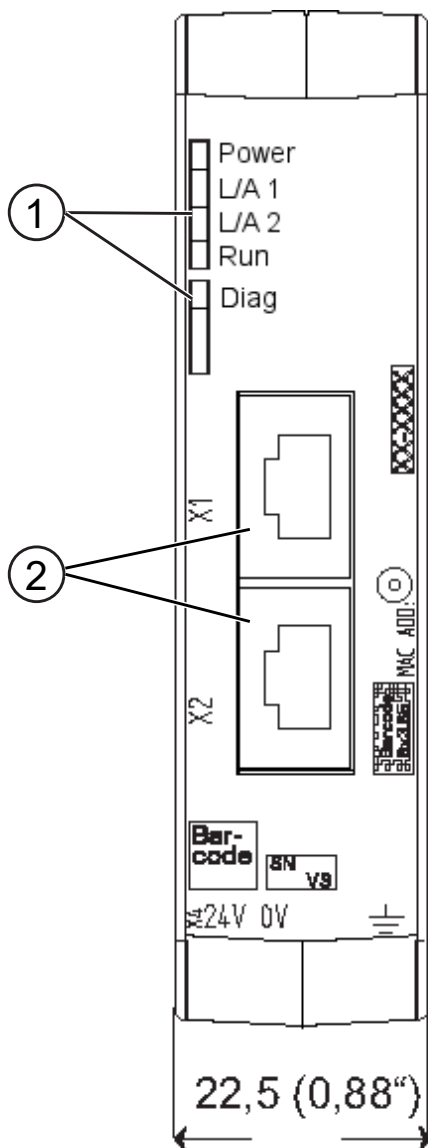

Illustration 2: Front view

1	Status LEDs
2	Fieldbus connection two RJ45 sockets for the connection to PROFINET

Top

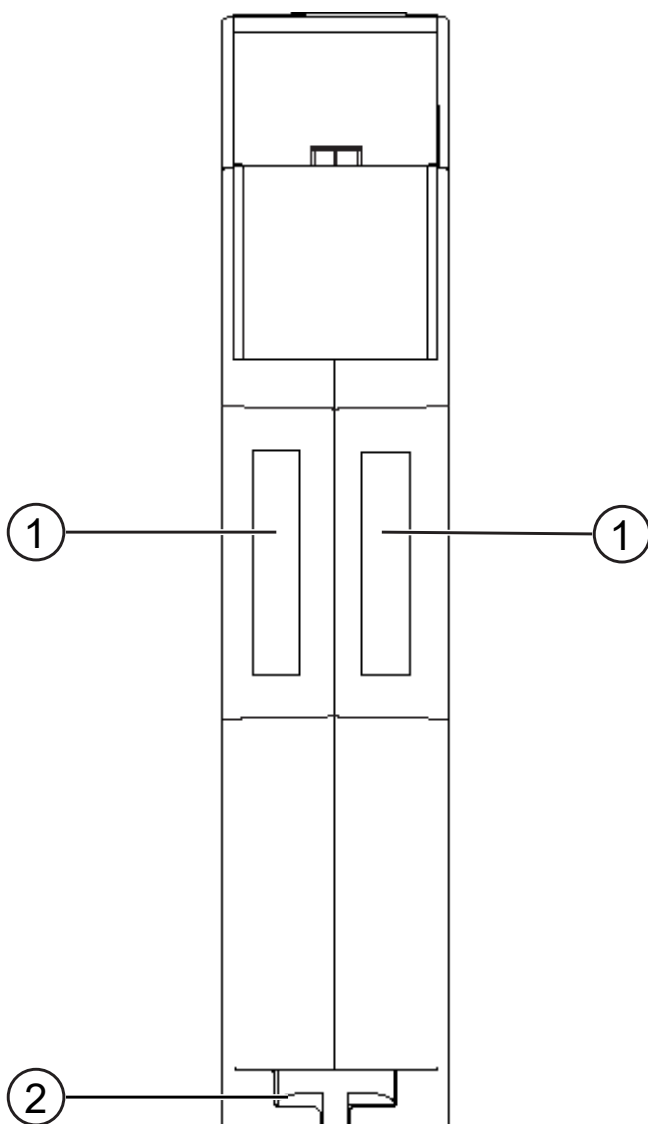

Illustration 3: Top

1	Interconnect ports for interconnecting the gateway components.
2	Locking clamps for securely attaching the gateway component to the DIN rail.

Bottom

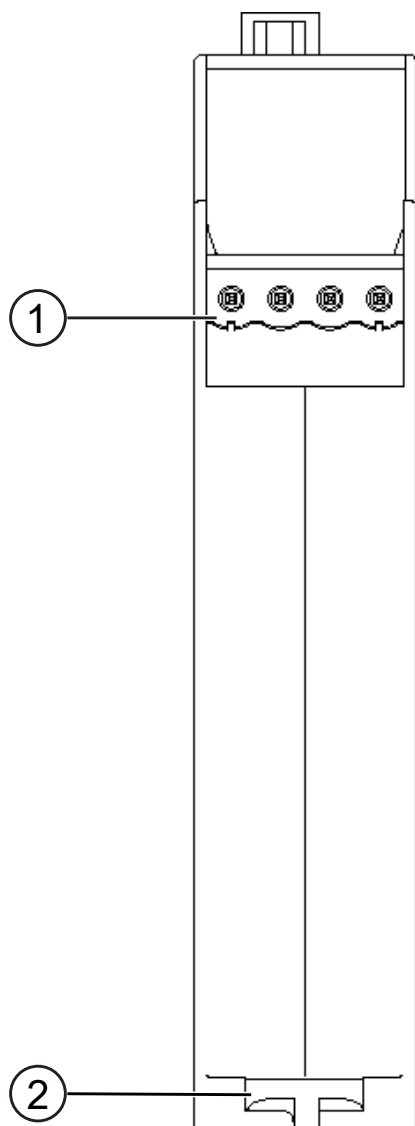

Illustration 4: Bottom

1	Mains connection with 24 V supply voltage
2	Locking clamps for securely attaching the gateway component to the DIN rail

3.3 Status LEDs

The signals of the status LEDs for PROFINET have the following meaning:

LED designation	Signal	Meaning
Power	off	The gateway component is not in operation
	flashes, green	Initialization phase not yet completed
	on, green	Operational
	flashes, red	Correctable error (e.g. second gateway component missing)
	on, red	Serious error/defect in the gateway component
Link/Traffic Port 1	off	No connection to a network
	on, green	Network cable is plugged in
	flashes, green	Data packets sent or received
Link/Traffic Port 2	off	No connection to a network
	on, green	Network cable is plugged in
	flashes, green	Data packets sent or received
Run	off	No connection to a network
	on, green	PROFINET controller is in operating state
	1 flash, green	PROFINET controller connected, but no data processing takes place
	flashes 1 Hz, green	Signaling. Triggered by tool to identify the gateway component
Diagnosis	off	Everything OK
	on, red	Gateway component reports diagnostic data
	flashes 2 Hz, red	No connection to the controller No PROFINET name set in the gateway component
	flashes 1 Hz, green	Signaling. Triggered by tool to identify the gateway component

4 Installation

4.1 Preparations for Inteference-free Operation

In the following section we have compiled some general information for you that is important for interference-free operation. If you are already acquainted with this topic, you can skip to the next section. There, you will learn about which conditions are necessary for installing the gateway component.

Cable routing

Route your cables separately in cable groups. This will protect your gateway from any unintended electromagnetic interferences.

The following groups should be routed separately from each other:

Group	Line
A	Data and power supply lines for: DC voltage below 60 V AC voltage below 25 V
B	Data and power supply lines for: DC voltage between 60 V and 400 V AC voltage between 25 and 400 V
C	Power supply lines above 400 V

- You can route cables of the same group together in cable ducts or bundles.
- Cables of group A and B:
 - Route the groups in separate bundles or
 - in cable ducts at a minimum distance of 10 cm from each other.
- Cables of group C
 - Route the groups in separate bundles or
 - in cable ducts at a minimum distance of 50 cm from the other groups.

Shielding

Shield your cables. This will reduce any unintended electromagnetic interferences.

Potential Equalization

Potential differences occur when devices are connected to different earths. These potential differences cause malfunctions.

To prevent malfunctions, you have to route an equipotential equalization conductor.

When doing so, bear in mind the following points:

- Select an equipotential equalization conductor with low impedance.
- Select the following as a reference value for the cross-section of the potential equalization cable:
 - 16 mm² for potential equalization cables of up to 200 m in length
 - 25 mm² for potential equalization cables of more than 200 m in length
- Use potential equalization cables made of copper or galvanized steel.
- Connect potential equalization cables extensively with the earth rail.

- The smallest surfaces possible should be sandwiched between potential equalization cables and signal cables.

If the devices of the control system are connected by shielded signal cables that are earthed on both sides, the impedance must be 10 % of the shielding impedance.

4.2 Requirements

The Gateway module was designed for use in a control cabinet.

- ✓ The protection class of the control cabinet must be equivalent to at least IP54.
- ✓ For installation in the control cabinet you need a DIN rail 35 x 7.5 mm (EN50022).
- a) Install the DIN rail horizontally in the control cabinet according to the manufacturers' specifications. Make sure that the Gateway module has sufficient distance to other devices.

NOTICE

Your gateway could be damaged if temperatures are too high.

- a) Make sure that the ambient temperature in the control cabinet is less than 60 °C.
- b) Keep the ventilation slots unobstructed. These must not be covered by cables etc.
- c) Maintain sufficient distance from other devices.

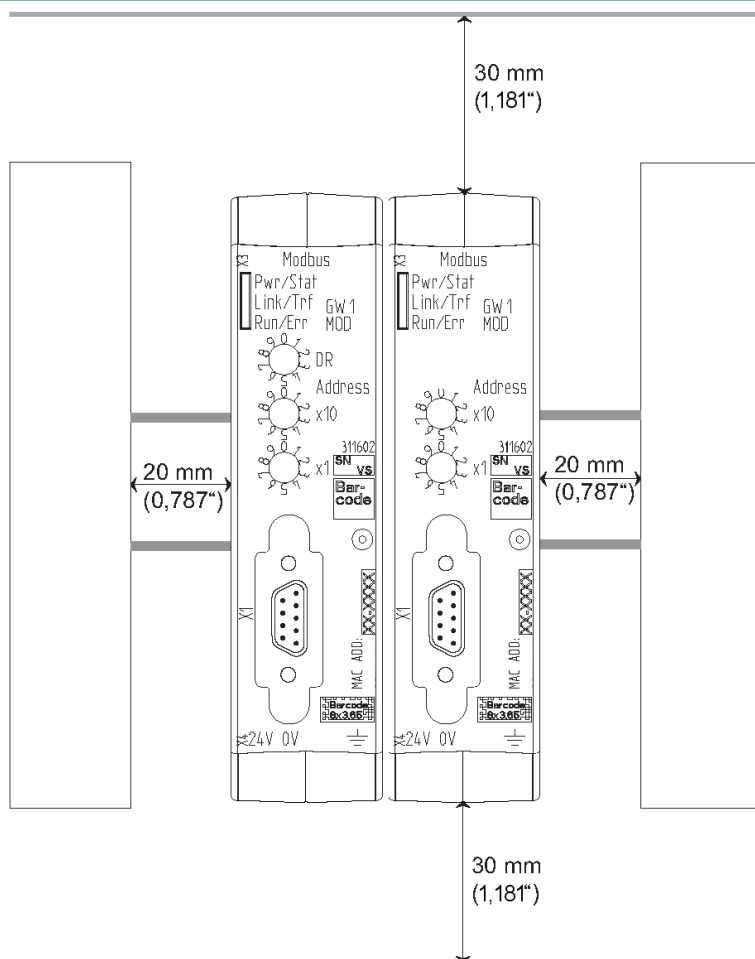

Illustration 5: Distances for installation

- b) Connect each gateway component individually to functional earth. Make sure that the power supplies of both gateway components have the same ground.
- ⇒ Your control cabinet now meets all the requirements for installing the gateway components.

4.3 Connecting Gateway Components

In order to attain a fully functional gateway, you have to interconnect both gateway components.
 a) Connect an interconnect port to each gateway component using the plug-in jumper provided.

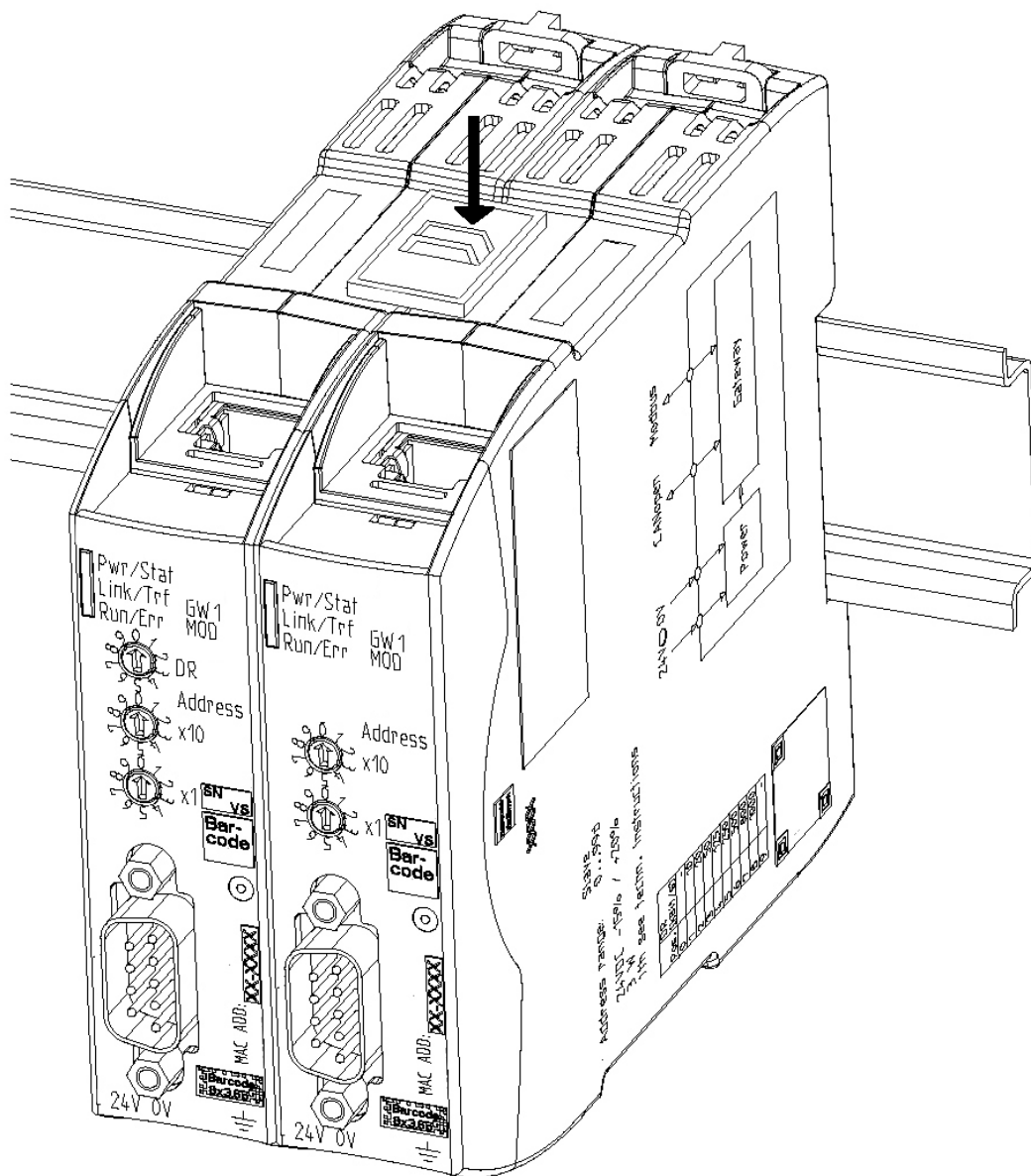

Illustration 6: Connecting gateway components

⇒ You can now install the gateway in the control cabinet.

NOTICE

Only ever interconnect two gateway components.

If you connect additional components, severe defects could result on all devices.

4.4 Installing a Gateway in the Control Cabinet

- a) Hold the grid element of the gateway component against the top-hat rail.
- b) Press down the locking elements towards the gateway.
- c) Make sure that the gateway is firmly attached to the DIN rail.

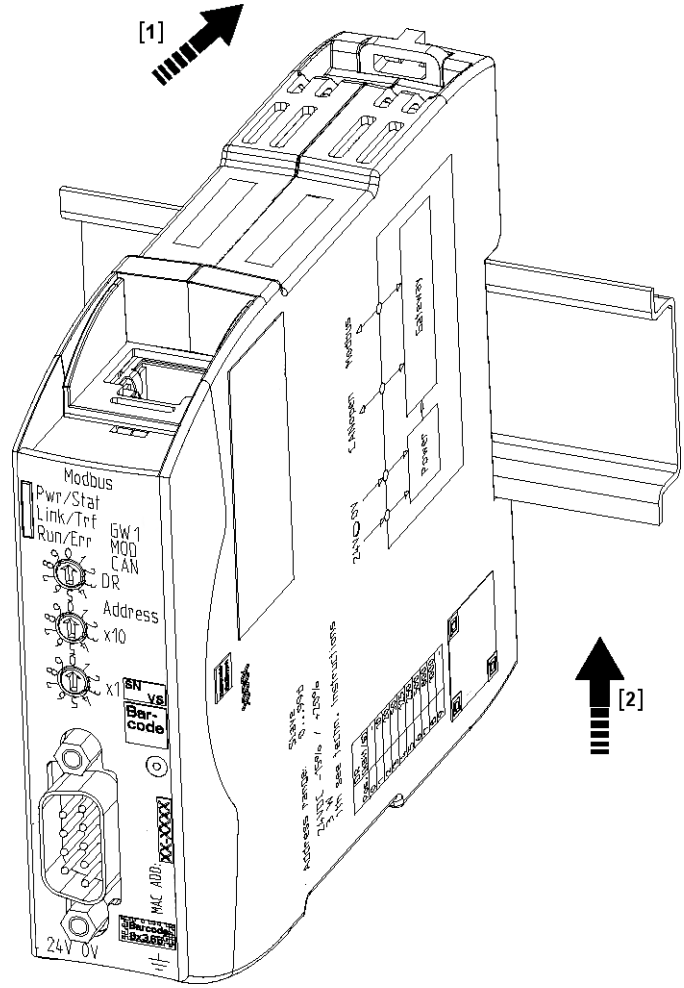

4.5 Connecting a Gateway to the Fieldbus

To connect the gateway component to PROFINET, you need two RJ45 connectors. The pin assignment complies with the specifications of the PNO.

Pin	Meaning
1	TX+
2	TX -
3	RX+
4	Do not connect!
5	Do not connect!
6	RX-
7	Do not connect!
8	Do not connect!

4.6 Connecting the Power Supply

To connect the gateway component to the power supply, you need a spring-loaded terminal (e.g. Metz-Connect SP995xxVBNC).

Lay a separate supply line to the power supply for each gateway component and make sure that the GND are connected to each other at the power supply. Connect FE to PE with low resistance.

NOTICE

Connect the two gateway components to the power supply.

a) Ensure in particular that no potential differences occur between the GND pins (2).

Pin assignment:

Pin	Assignment
1	24 V for module supply
2	GND
3	Do not connect!
4	Functional earth

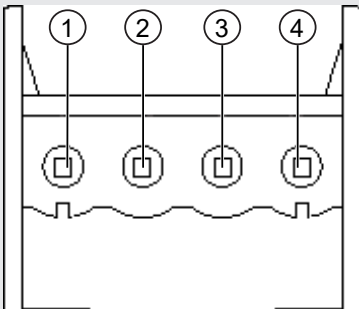

5 Configuration

5.1 Supported Size of Process Data

The gateway component for PROFINET supports an input and an output data range of 512 bytes each:

- The first 320 bytes of each area are intended for the exchange of cyclic process data.
- The remaining 192 bytes can be used for acyclic data exchange (records).

NOTICE

Bear in mind that the maximum length of the process data is always determined by the fieldbus with the shorter data length.

5.2 Setting Station Name

Since names are in most cases easier to handle than complex IP addresses, you can assign a station name to the gateway component.

You set the station name using the software of your PROFINET controller.

According to the definition RFC 5890, attention must be paid to the name assignment rules:

- Data should be specified in the Octet string type.
- Limitation to a total of 240 characters (letters "a" to "z", digits "0" to "9", hyphen or dot)
- A name element of the device name must be separated by a dot and can have a maximum of 63 characters.
- No special characters such as umlauts, brackets, underscore, blanks, etc.
- The hyphen is the only special character allowed.
- The device name must not begin or end with a dot.
- The device name must not begin with numbers.
- The device name must not have the form n.n.n.n (n = 0...999).
- The device name must not begin with the character string "port-xyz-" (x,y,z = 0...9).
- The device name may only begin with "xn-" if the original string contains values other than "0" to "9" and "a" to "z".
- The field "NameOfStationValue" must not end with 0.

Examples of valid names:

"device -1.machine- 1.plant- 1.vendor"

"mühle1.ölmühle1.plant.com" is coded as " xn-mhle1-kva.xn-lmhle1 -vxa4c.plant.com"

5.3 Exchanging Data Cyclically

To configure the gateway component, you have to perform the appropriate settings with the configuration software of your PROFINET controller.

The gateway component is equipped with virtual slots (installation positions). These slots are used by PROFINET controllers to uniquely address selected process data. There is one module in each slot. You can assign process data to be exchanged to these modules.

Slot	Module	Id	Offset
0	DAP	0x80050000	--
1	Input 16	0x00000005	Output Off 0
2	Input 16	0x00000005	Output Off 16
3	Input 32	0x00000006	Output Off 32
4	Input 32	0x00000006	Output Off 64
5	Input 32	0x00000006	Output Off 96
6	Input 64	0x00000007	Output Off 128
7	Input 64	0x00000007	Output Off 192
8	Input 64	0x00000007	Output Off 256
9	Output 16	0x00000050	Input Off 0
10	Output 16	0x00000050	Input Off 16
11	Output 32	0x00000060	Input Off 32
12	Output 32	0x00000060	Input Off 64
13	Output 32	0x00000060	Input Off 96
14	Output 64	0x00000070	Input Off 128
15	Output 64	0x00000070	Input Off 192
16	Output 64	0x00000070	Input Off 256

Info! The gateway component supports only one submodule with data per module.

In the following tables you will find a detailed overview of all modules.

DAP (Device Access Point)

Description:	DAP
Module ID:	0x80050000
Used in slot:	0
Total number of input bytes:	0
Total number of output bytes:	0
Number of submodules:	3

Submodules for record access

Submodule ID:	0x00000001
Subslot:	0x0001
Number of input bytes:	0
Number of output bytes:	0

Submodule that represents the entire PROFINET device

Submodule ID:	0x0000000a
Subslot:	0x8000
Number of input bytes:	0
Number of output bytes:	0

Submodule representing port 1

Submodule ID:	0x0000000b
Subslot:	0x8001
Number of input bytes:	0
Number of output bytes:	0

Submodule representing port 2

Submodule ID:	0x0000000c
Subslot:	0x8002
Number of input bytes:	0
Number of output bytes:	0

Input 16 Byte

Description:	Input 16 Byte
Module ID:	0x00000005
Used in slot:	1 – 2
Total number of input bytes:	16
Total number of output bytes:	0
Number of submodules:	1

Submodule ID:	0x00000001
Subslot:	0x0001
Number of input bytes:	16
Number of output bytes:	0

Input 32 Byte

Description:	Input 32 Byte
Module ID:	0x00000006
Used in slot:	3 – 5
Total number of input bytes:	32
Total number of output bytes:	0
Number of submodules:	1

Submodule ID:	0x00000001
Subslot:	0x0001
Number of input bytes:	32
Number of output bytes:	0

Input 64 Byte

Description:	Input 64 Byte
Module ID:	0x00000007
Used in slot:	6 – 8
Total number of input bytes:	64
Total number of output bytes:	0
Number of submodules:	1

Submodule ID:	0x00000001
Subslot:	0x0001
Number of input bytes:	64
Number of output bytes:	0

Output 16 Byte

Description:	Output 16 Byte
Module ID:	0x00000050
Used in slot:	9 – 10
Total number of input bytes:	0

Total number of output bytes:	16
Number of submodules:	1
Submodule ID:	0x00000001
Subslot:	0x0001
Number of input bytes:	0
Number of output bytes:	16

Output 32 Byte

Description:	Output 32 Byte
Module ID:	0x00000060
Used in slot:	11 – 13
Total number of input bytes:	0
Total number of output bytes:	32
Number of submodules:	1

Submodule ID:	0x00000001
Subslot:	0x0001
Number of input bytes:	0
Number of output bytes:	32

Output 64 Byte

Description:	Output 64 Byte
Module ID:	0x00000070
Used in slot:	14 – 16
Total number of input bytes:	0
Total number of output bytes:	64
Number of submodules:	1

Submodule ID:	0x00000001
Subslot:	0x0001
Number of input bytes:	0
Number of output bytes:	64

5.4 Exchanging Data Acyclically (Records)

The gateway component supports records. This access type is useful for all events that do not have to be repeated regularly (e.g. sending parameter data in the start-up phase).

Another advantage of records is that you can write continuously ascending areas at once.

Example: Index 0x1005 writes byte 10 to byte 19 with 10 bytes of data in the output process mapping.

You can use all 512 bytes of the input and output area to read or write records.

NOTICE

Note that the first 320 bytes of the input and output area are used for cyclic data transmission.

Records that you address with index 0x0000 - 0x00ff or 0x1000 - 0x10ff can be overwritten by the cyclic data transmission.

Addressing

All records are addressed via API 0, Slot 0, Subslot 1. The data is transferred in Big Endian format. In the Big Endian format, the higher-value bytes are transmitted first and stored at the memory locations with the lowest addresses.

Two bytes are always addressed per index:

Offset 0 + Offset 1 → Record 0

Offset 510 + Offset 511 → Record 255 (0x00ff)

Index 0x0000 - 0x00ff contains the input data sent by the partner gateway component.

Index 0x1000 - 0x10ff contains the output data sent to the partner gateway component.

State of the Partner Gateway Component

You can read information about the state of the partner gateway component via API 0, Slot 0, Subslot 1, Index 0x2000 :

Offset	Length	Element	Comment
0	4	Serial number	
4	2	Module type	KUNBUS internal module type
6	2	Hardware revision	
8	2	Major software version	
10	2	Minor software version	
12	4	Subversion revision	Source code versioning
16	2	Fieldbus input length	
18	2	Fieldbus output length	
20	1	Bus state	
20	2	Feature descriptor	Supported features of the gateway component

5.4.1 I&M Data

Identification & Maintenance Data

I&M data are data structures that are used to uniquely identify the gateway component in the PROFINET network.

The gateway component supports the I&M data 0-4. This I&M data is available in Slot 0, Subslot 1. The data can be read and if necessary written by the PROFINET controller via the data index 0xaff0-0xaff4.

I&M 0 Data

I&M 0 data contains information about the gateway component. They can be read by the PROFINET controller via Record Read with Api 0, Slot 0, Subslot 1, Index 0xaff0.

You can find the following information on the gateway component via the I&M 0 data:

- Vendor ID
- Order ID
- Serial Number
- Hardware Revision
- Software Revision
- Revision Counter
- Profile ID

- Profile specific type
- I&M Version

I&M 1 Data

I&M 1 Data is stored permanently in the gateway component. They can be read and written by the PROFINET controller via Record Read with Api 0, Slot 0, Subslot 1, Index 0xaff1.

I&M 2 Data

I&M 2 Data is stored permanently in the gateway component. They can be read and written by the PROFINET controller via Record Read with Api 0, Slot 0, Subslot 1, Index 0xaff2.

I&M 3 Data

I&M 3 Data is stored permanently in the gateway component. They can be read and written by the PROFINET controller via Record Read with Api 0, Slot 0, Subslot 1, Index 0xaff3.

I&M 4 Data

I&M 4 Data is stored permanently in the gateway component. They can be read and written by the PROFINET controller via Record Read with Api 0, Slot 0, Subslot 1, Index 0xaff4.

5.4.2 Diagnosis Alarm

If communication to the partner gateway component is interrupted, the gateway component for PROFINET sends a diagnosis alarm to the controller:

- The alarm is sent out from API 0, Slot 0, Subslot 1
- The alarm is sent as channel diagnosis with channel 0x8000
- The alarm has the priority "Maintenance Required"
- Error type is 0x0100 (first user defined error)
 - a) Check whether the plug-in jumper is connected correctly to both gateway components.
 - b) Check whether the partner gateway component is connected to the power supply.

As soon as the communication between the two gateway components is working, the gateway component for PROFINET sends a diagnostic telegram to the PROFINET controller.

More detailed information on the topic of diagnosis alarm can be found in the specifications for PROFINET.

6 Integrated Servers

6.1 FTP-Server

The FTP server is necessary for updating HTML files of the web server and for transmitting firmware updates to the module.

You can access the FTP server from user level 2. For this purpose, the same logon data as for the web server is valid. The "Level" is defined in the file "password.xml". How to do this is explained in the section "Logging on to the web server" [► 24].

Web Server Files

You will find files for the web server in the "Web" subfolder.

6.2 Webserver

The Gateway has a web server. You can access it from any browser.

Calling the Web Server

- a) Verbinden Sie das Gateway mit dem PC.
 - b) Open your browser.
 - c) Enter the IP address as a URL (e.g. : http://192.168.0.8)
- ⇒ You can log in now.

Logging on to the Web Server

You can log on to the web server as an administrator or as a user.

The user may:

- Read process data of the Gateway .

Credentials (default):

User name User

Password: 1111

The administrator may:

- Change passwords
- Change network settings

Credentials (default):

User name Admin

Password: 1701

Tip! As admin you can change the password directly in the web server.

Display Process Data

For the interfaces in the selected mode, the transmitted data can be displayed cyclically.

Click the "Show" buttons to view the process data of the desired input and output range. The following example shows the process data of the fieldbus.

6.3 Firmware Update

In the following sections you can learn how to update the firmware of your gateway component.

You will need:

- Windows PC
- Gateway component
- LAN cable
- FTP software (e.g. Filezilla)

Configuring Network

To access the FTP server, you must create a network configuration. For this example, we will use these settings:

- Network 192.168.1.0/24
- IP address Windows PC 192.168.1.1
- IP address GW-ProfiNET-TPS-1 192.168.1.10

Configuring the IP address (Windows PC)

- Click on "Start".
- Select "System Control".
- Click on "Network and Sharing Center".
- Click on "Change adapter settings".

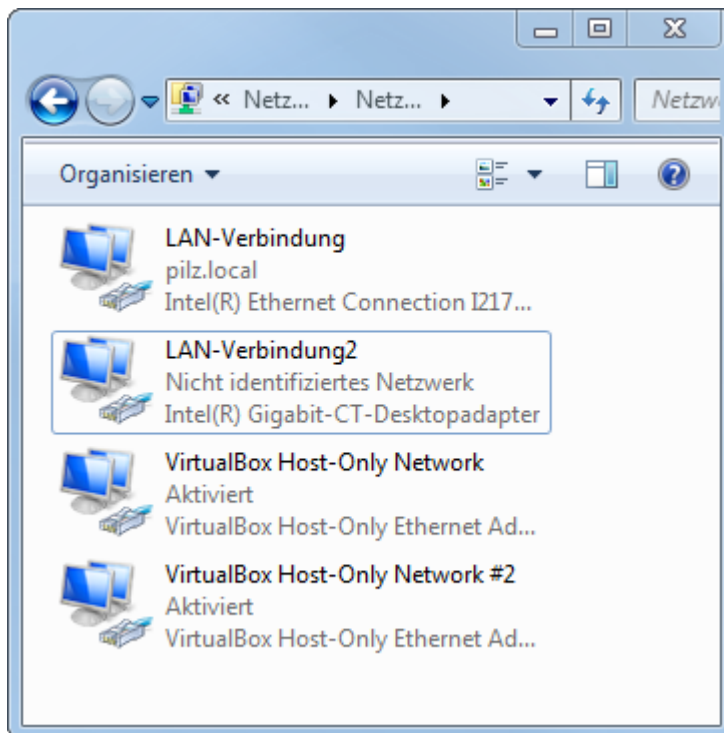

- Right-click on the desired connection.
- Select "Properties".

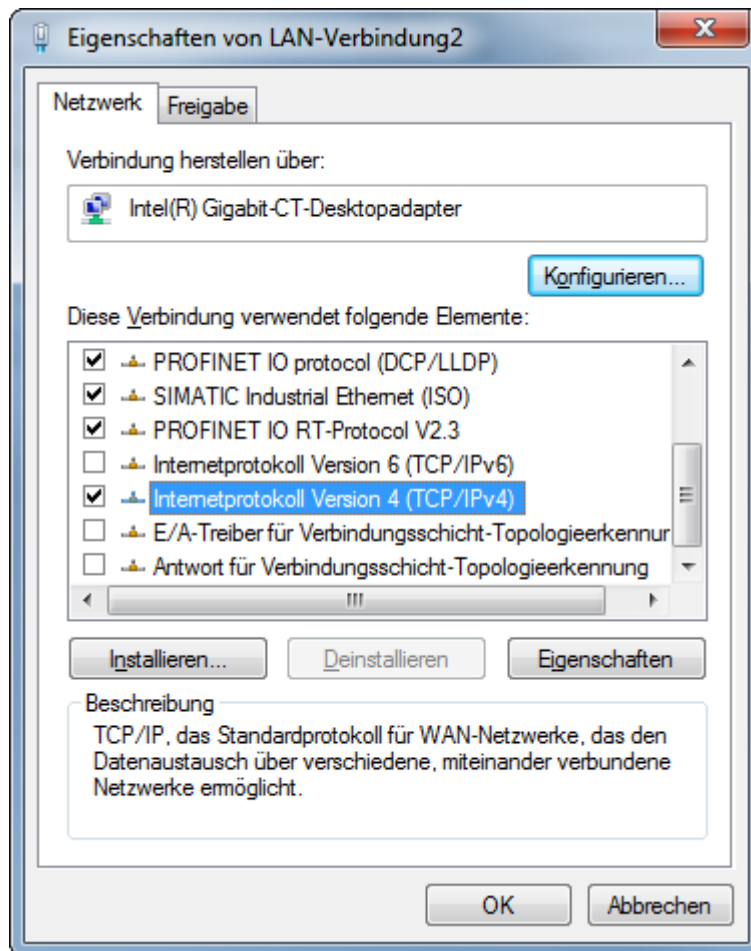

- g) Select "Internet Protocol Version 4" with a double click.
- h) Set the desired IP address.
- i) Click on "OK".

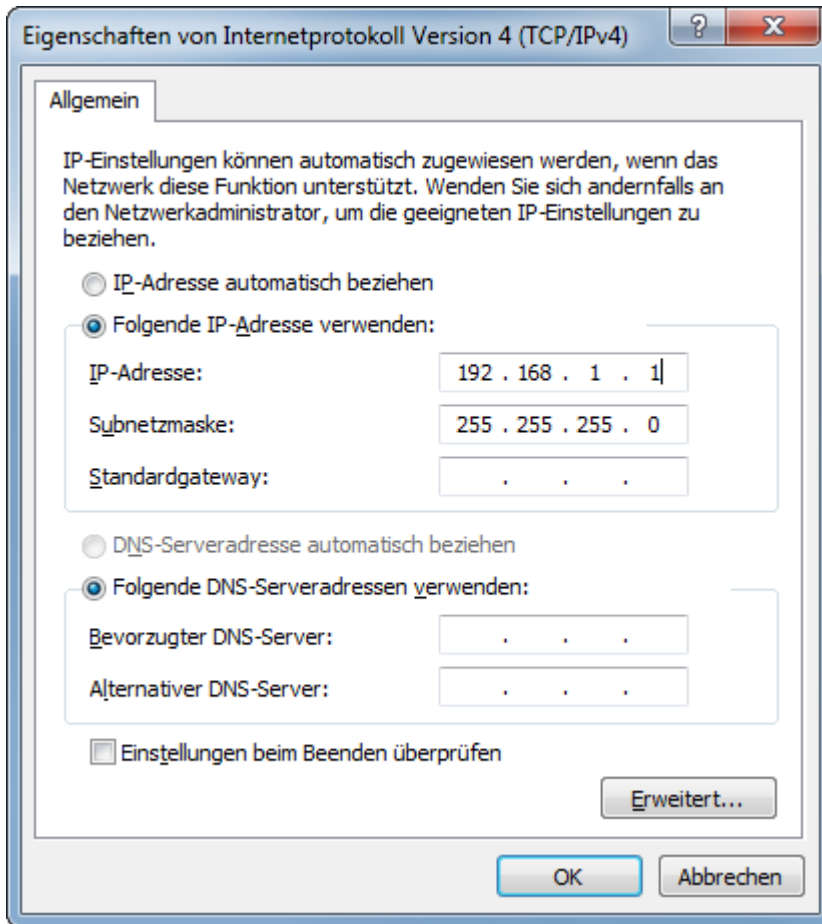

Connecting the Gateway Component to the PC

- ✓ Connect the Ethernet interface of the gateway component to the Ethernet interface on your PC. A LAN cable is required.
- a) Download Proneta to your PC.
- b) Unpack the current version.

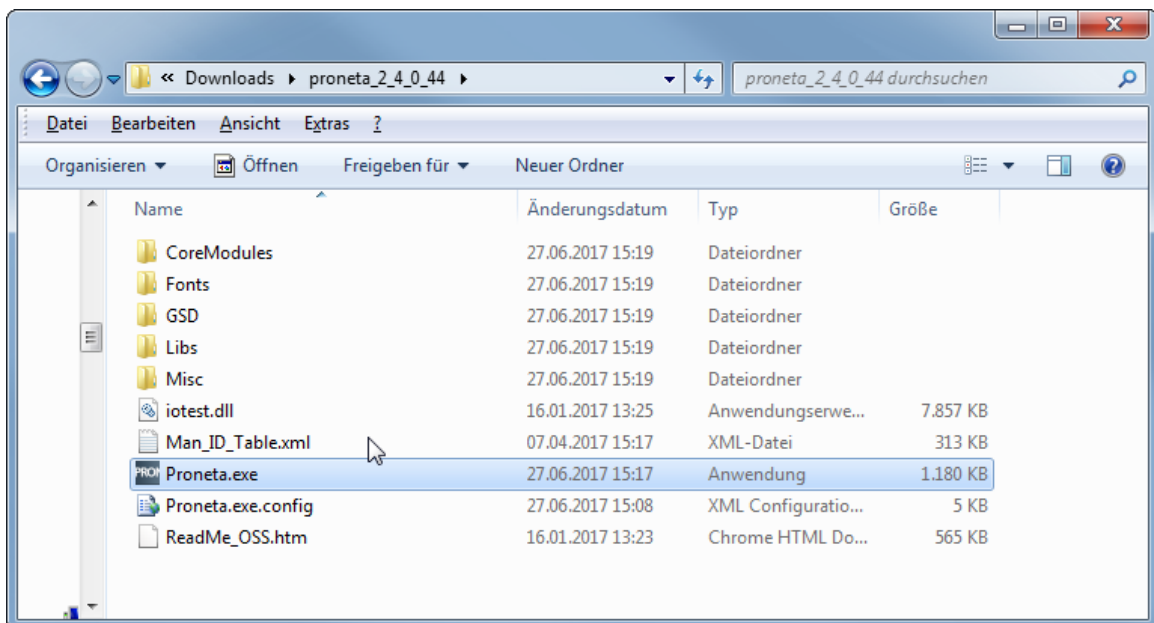

- c) Open "Proneta.exe" with a double click.

⇒ Proneta is opened.

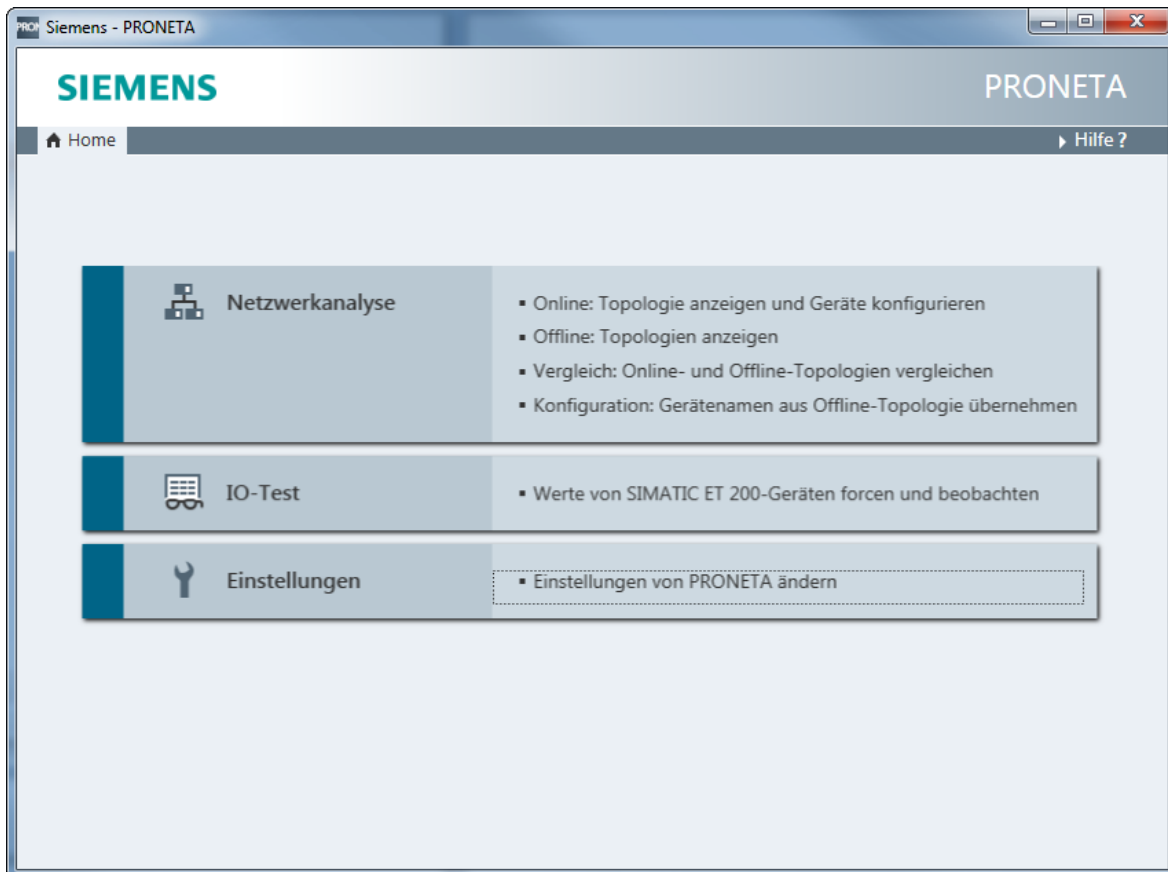

- d) Click on "Settings".
- e) Click on the "Network Adapter" tab.
- f) Select the desired network interface.

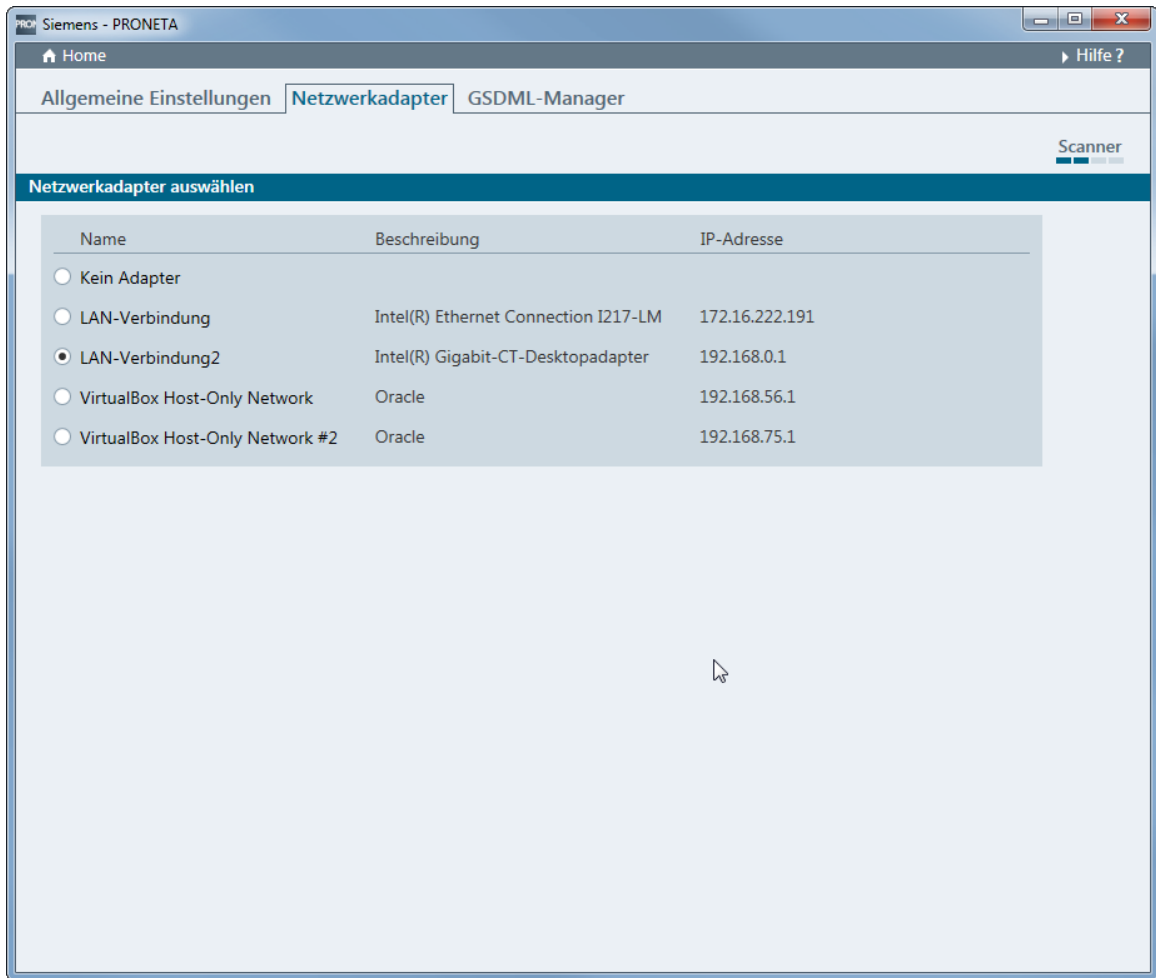

g) Click on "Home".

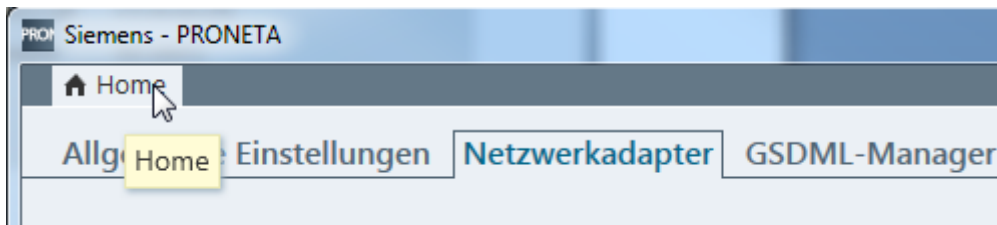

h) Click on "network analysis".

⇒ The network analysis is opened. The network connection between Windows PC and the gateway component is displayed.

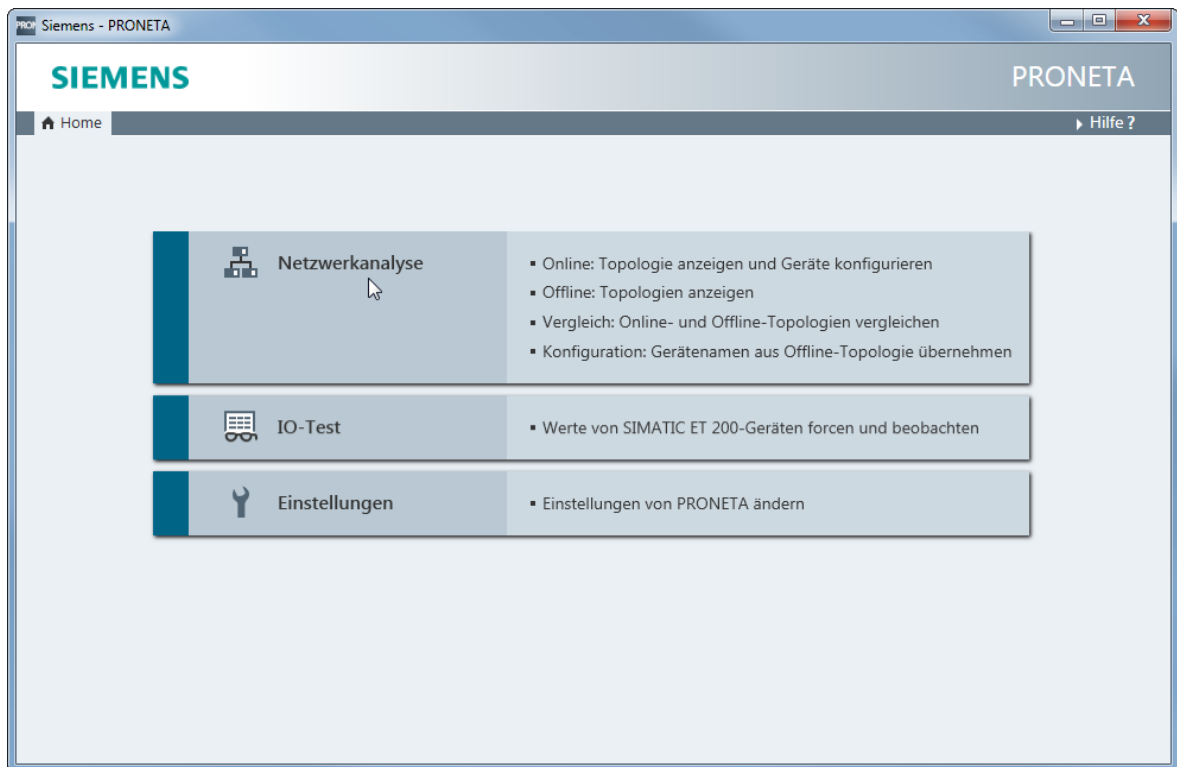

- i) Select the gateway component by double-clicking on it.
- ⇒ The configuration interface opens.
- j) Enter the network configuration here.

Netzwerkparameter setzen

Bitte wählen Sie Ihre Netzwerkparameter aus

Gerätenamen zuweisen

IP-Konfiguration

Statische IP-Konfiguration

IP-Adresse

Netzwerkmaske

Router als Gateway verwenden

IP-Konfiguration vom DHCP-Server ermitteln gemäß

MAC-Adresse

GeräteName

Client-ID

Geräte, die an ein Firmennetzwerk oder an das Internet angeschlossen werden, müssen gegen unbefugten Zugriff angemessen geschützt sein, z. B. durch die Verwendung von Firewalls und Netzwerksegmentierung. Weiterführende Informationen über Industrial Security finden Sie unter <http://www.siemens.com/industrialsecurity>

Einstellungen dauerhaft anwenden

k) Click on "Set".

⇒ The IP address is now set.

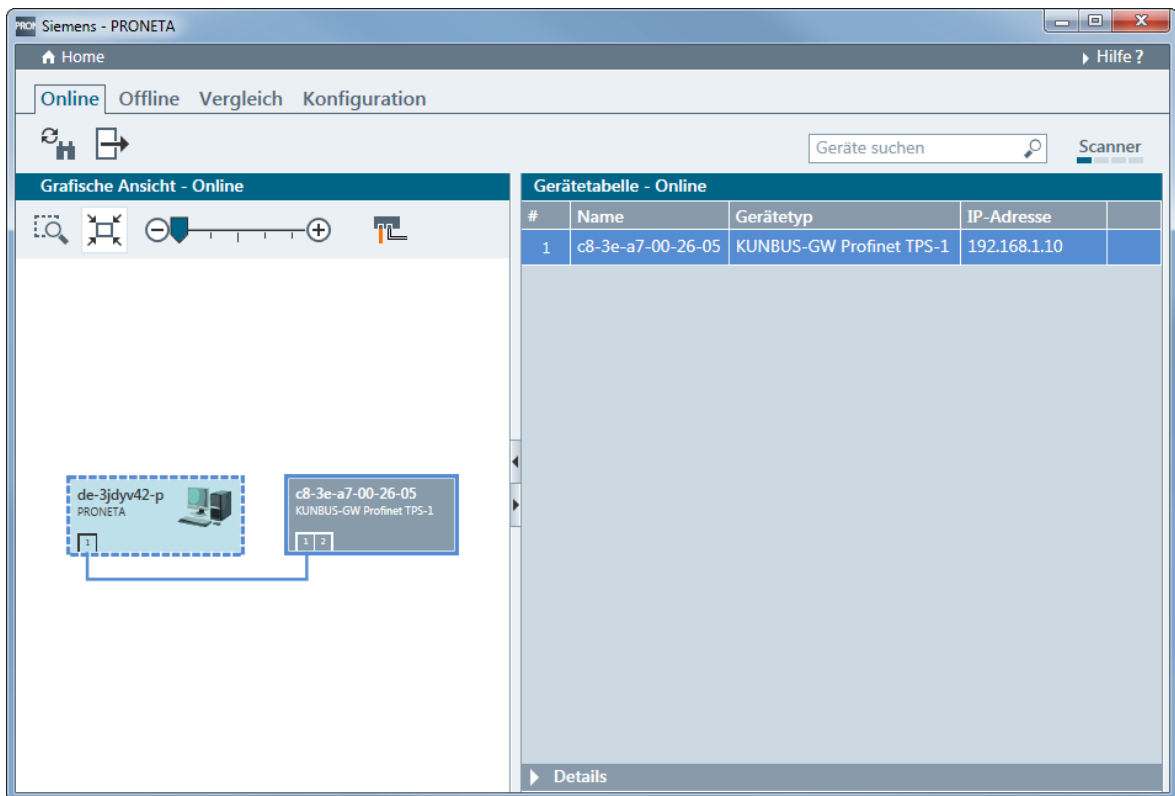

- l) Open the Windows console (with Windows+R "cmd").
 - m) Enter "ping" and the IP address of the gateway component.
- This allows you to check whether the configuration is correct.

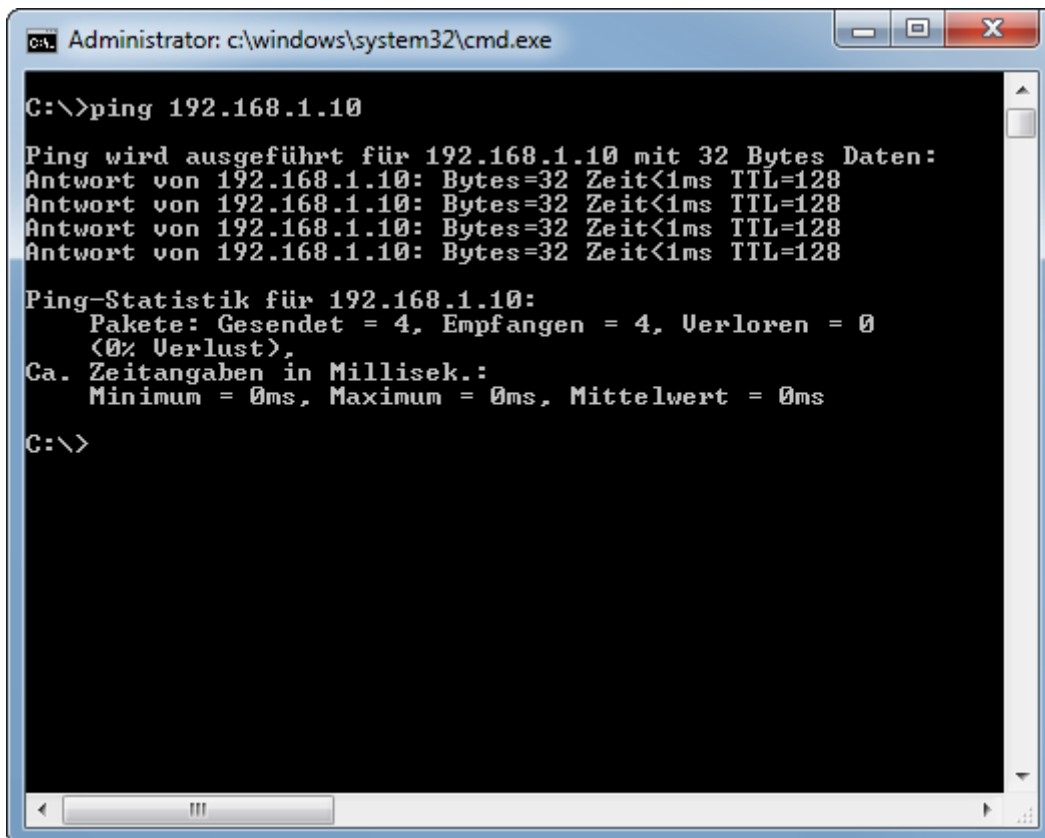

Setting up FTP Server

- ✓ You have installed a program for data transfer. We use FileZilla in this example. However, you can use other software.

- n) Open FileZilla.
- o) Click on "New server".
- p) Set the following parameters in the "General" tab:
 - IP address
 - Select "FTP" protocol
 - User name (Admin)
 - Password (1701).

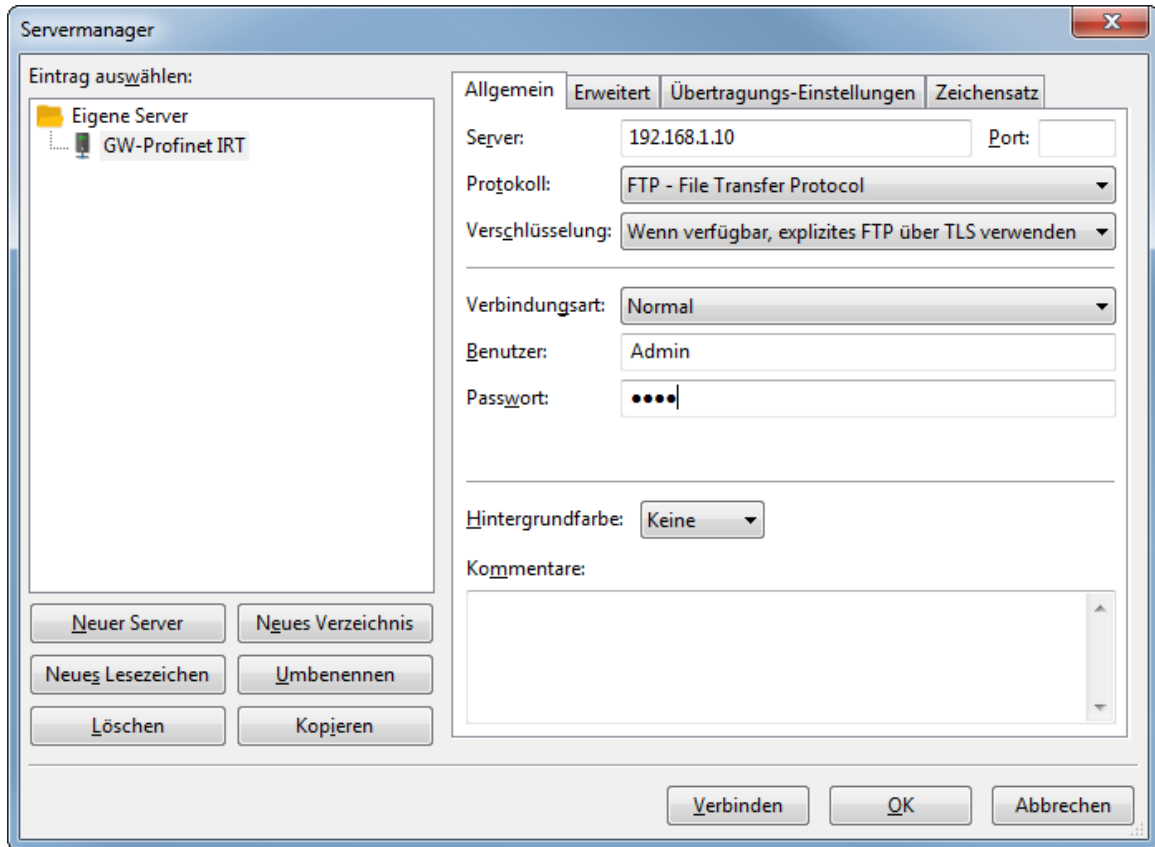

- q) Click on the "Advanced" tab.
- r) Check the box "Bypass proxy".

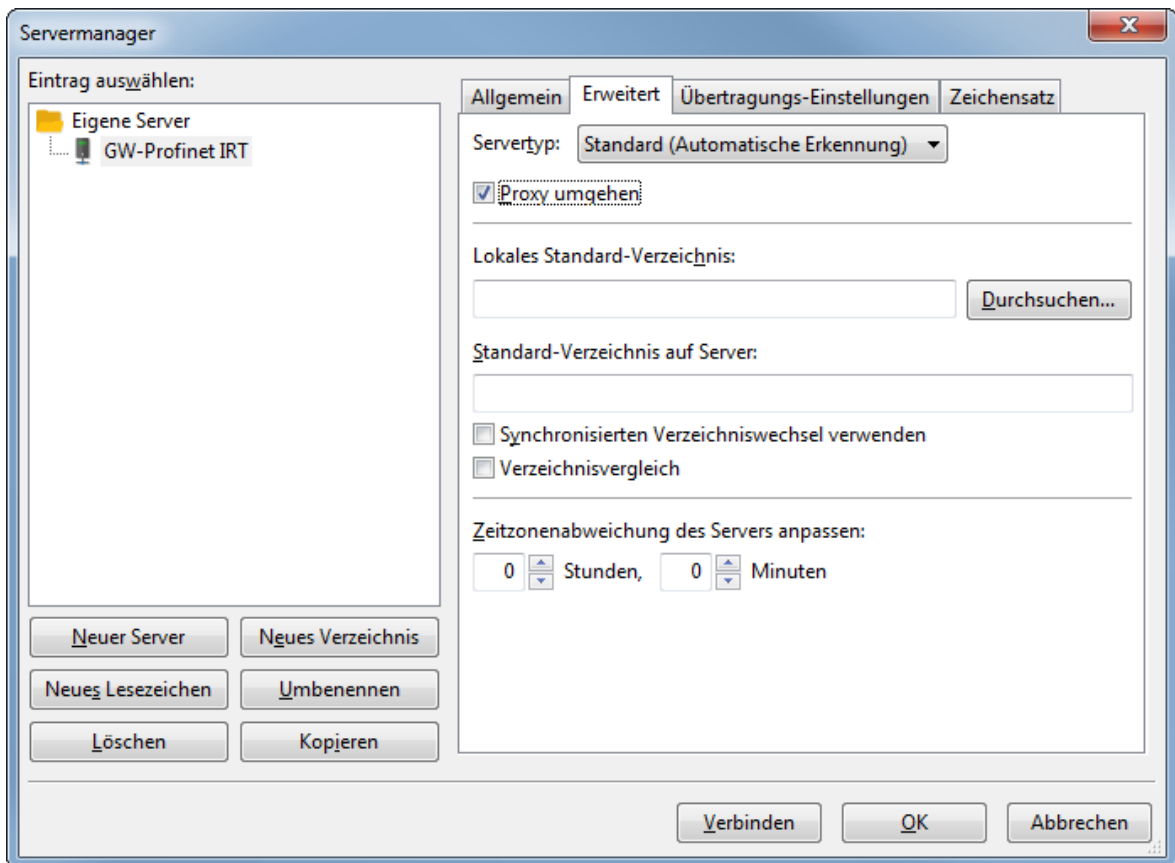

s) Click on "Connect".

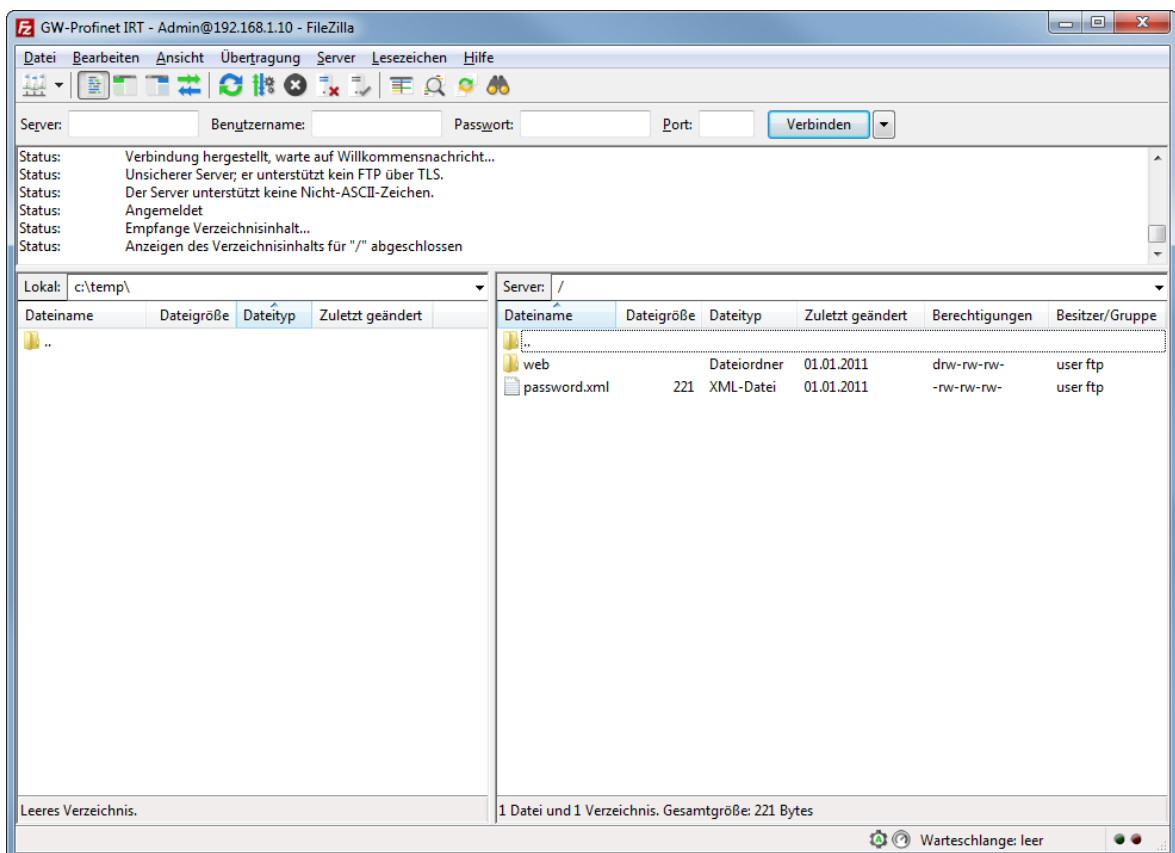

t) Copy the KFU file to the gateway component.

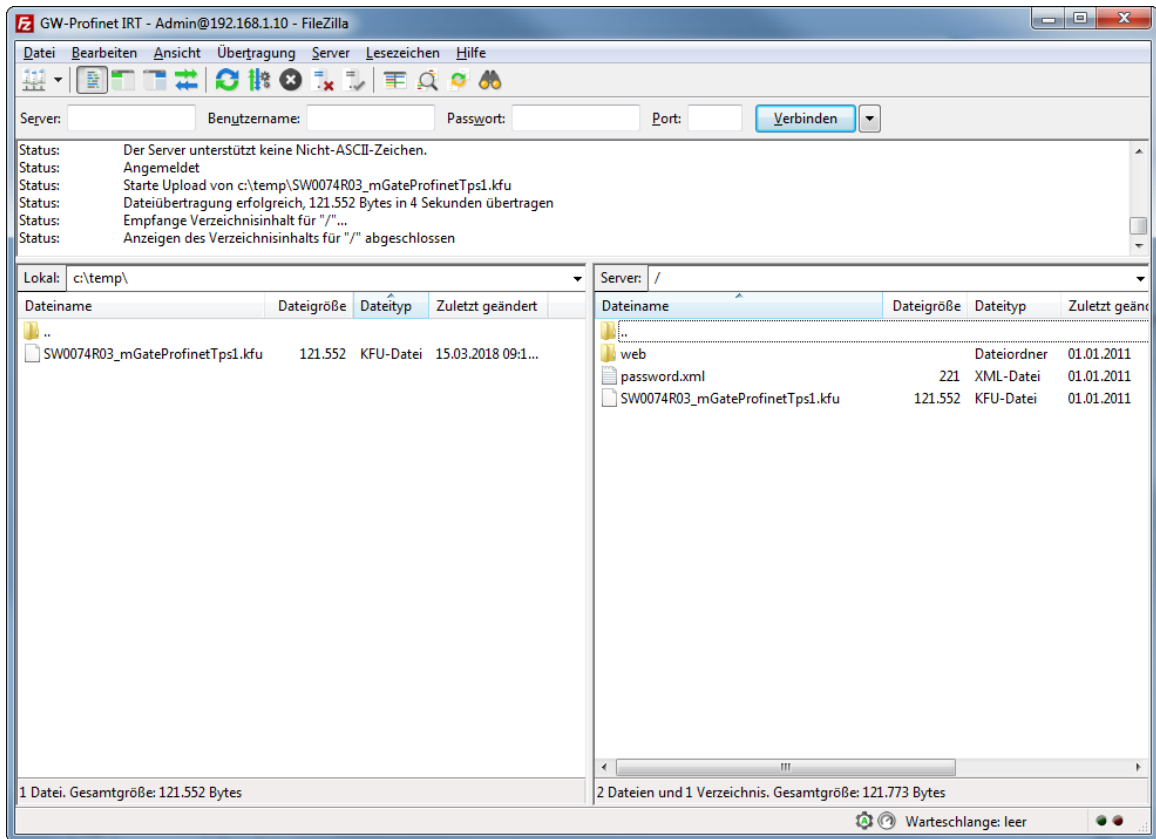

- u) Restart the gateway component.
- ⇒ Your firmware has been updated.

7 Technical Data

Dimensions	
Width	22.5 mm
Height	96 mm
Depth	110.4 mm
Weight	90 g
Electrical data	
Power supply	24VDC -15%/ +20%; 1.5W
Power consumption during operation (cyclical data exchange)	100 mA
Status display	LED
Environmental Conditions	
Ambient temperature	-30 °C – +55 °C
Storage temperature	-30 °C – +60 °C
Humidity	93% (at 40 °C)
Condensing	Not allowed
Protection class	
Control cabinet	IP54
Housing	IP20
Terminal area	IP20
Assembly data	
DIN rail	35 x 7.5 mm
Height	96 mm
Depth	110.4 mm
PROFINET interface	
Device type	Slave
Protocol	IRT
Maximum data length	
Total	1024 byte
– Input data	– 512 byte
– Cyclical data exchange	– 320 byte
– Acyclical data exchange	– 192 byte
– Output data	– 512 byte
– Cyclical data exchange	– 320 byte
– Acyclical data exchange	– 192 byte
Bitrate	100 MBit

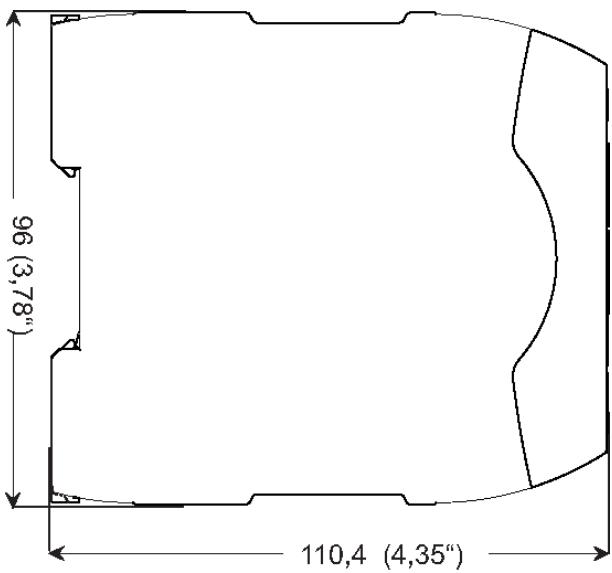

Illustration 7: Side dimensions

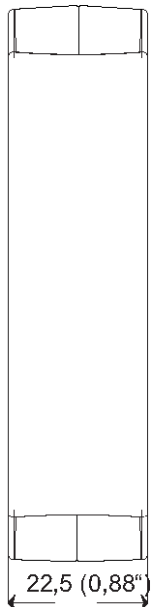

Illustration 8: Front dimensions

