

Han 24B / Han-Eco 24B Punching unit

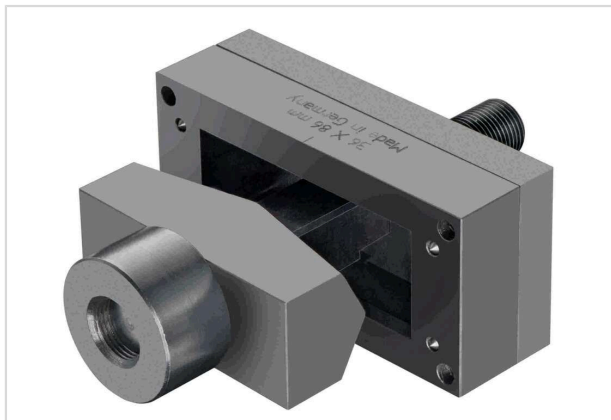

Image is for illustration purposes only. Please refer to product description.

Part number	09 99 000 0905
Specification	Han 24B / Han-Eco 24B Punching unit
HARTING eCatalogue	https://b2b.harting.com/09990000905

Identification

Category	Tools
Series of hoods/housings	Han [®] B Han-Eco [®] Modular
Type of tool	Punching units for hydraulic punch drivers

Version

Size	24 B
Plate thickness	≤2 mm structural grade carbon steel

Commercial data

Packaging size	1
Net weight	3,832 g
Country of origin	Germany
European customs tariff number	82073090
GTIN	5713140108257
eCl@ss	21049090 Hand tool (other, unspecified)