

## GaAs MMIC I/Q MIXER MODULE 4.0 - 8.5 GHz



### Typical Applications

The HMC-C009 is ideal for:

- Telecommunications Equipment
- Test Equipment
- Military Radios, Radar & ECM
- Space Systems

### Functional Diagram

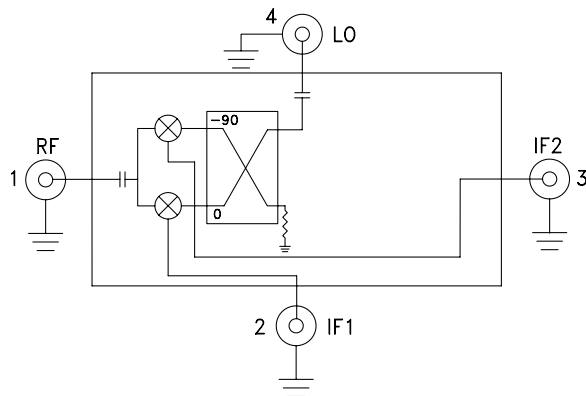

### Features

- Wide IF Bandwidth: DC - 3.5 GHz
- Image Rejection: 35 dB
- LO to RF Isolation: 40 dB
- High Input IP3: +23 dBm
- Hermetically Sealed Module
- Field Replaceable SMA Connectors
- 55 °C to +85 °C Operating Temperature

### General Description

The HMC-C009 is a passive I/Q MMIC mixer housed in a miniature hermetic module which can be used as either an Image Reject Mixer or a Single Sideband Upconverter. The module utilizes two standard Hittite double balanced mixer cells and a 90 degree hybrid fabricated on a GaAs MESFET process. This MMIC based module is a more reliable and consistent alternative to hybrid style I/Q Mixers and Single Sideband Converter assemblies. The module features removable SMA connectors which can be detached to allow direct connection of the modules I/O pins to a microstrip or coplanar circuit.

### Electrical Specifications, $T_A = +25^\circ\text{C}$ , $IF = 100\text{ MHz}$ , $LO = +15\text{ dBm}^*$

Parameter	Min.	Typ.	Max.	Min.	Typ.	Max.	Units
Frequency Range, RF/LO		4.0 - 8.5			5.5 - 7.5		GHz
Frequency Range, IF		DC - 3.5			DC - 3.5		GHz
Conversion Loss (As IRM)		7.5	10.5		7.5	9.5	dB
Image Rejection	22	35		28	34		dB
1 dB Compression (Input)		+14			+15		dBm
LO to RF Isolation	32	40		35	40		dB
LO to IF Isolation	14	20		15	20		dB
IP3 (Input)		+23			+23		dBm
Amplitude Balance		0.3			0.2		dB
Phase Balance		8			6		Deg

\* Unless otherwise noted, all measurements performed as downconverter.

Information furnished by Analog Devices is believed to be accurate and reliable. However, no responsibility is assumed by Analog Devices for its use, nor for any infringements of patents or other rights of third parties that may result from its use. Specifications subject to change without notice. No license is granted by implication or otherwise under any patent or patent rights of Analog Devices. Trademarks and registered trademarks are the property of their respective owners.

For price, delivery, and to place orders: Analog Devices, Inc., One Technology Way, P.O. Box 9106, Norwood, MA 02062-9106  
Phone: 781-329-4700 • Order online at [www.analog.com](http://www.analog.com)  
Application Support: Phone: 1-800-ANALOG-D

**GaAs MMIC I/Q MIXER MODULE  
4.0 - 8.5 GHz**



Data taken As IRM With External IF Hybrid

**Conversion Gain vs. Temperature**

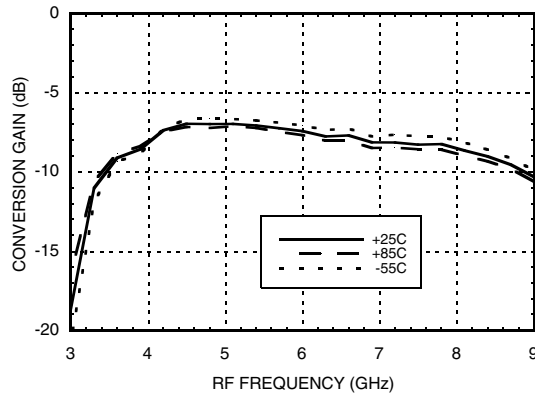

**Image Rejection vs. Temperature**

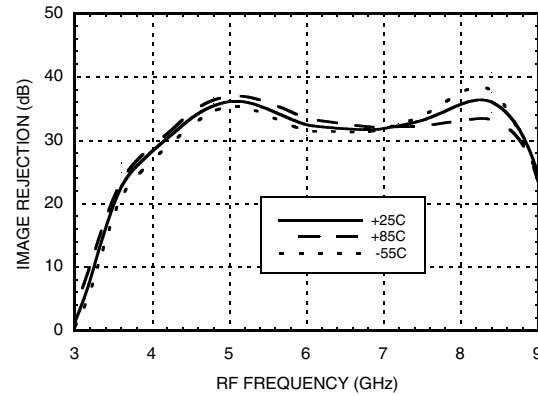

**Conversion Gain vs. LO Drive**

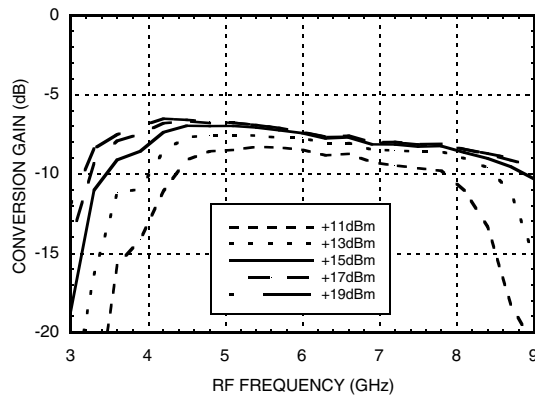

**Return Loss**

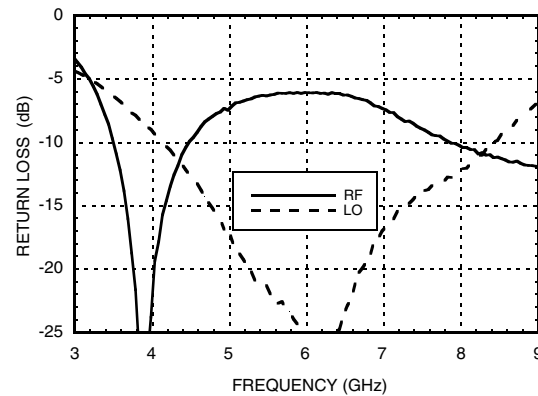

**Input P1dB vs. Temperature**

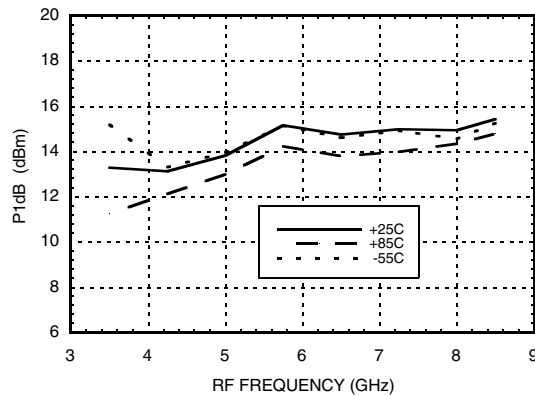

**Input IP3 vs. LO Drive**

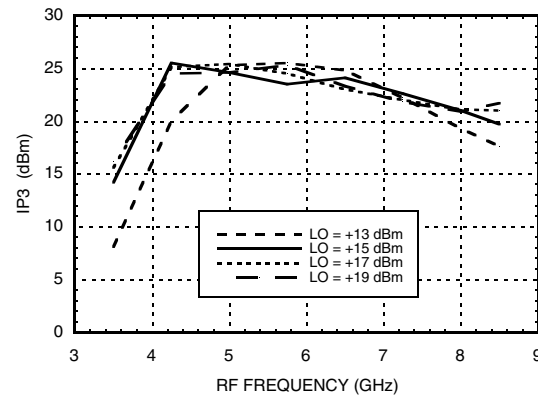

Information furnished by Analog Devices is believed to be accurate and reliable. However, no responsibility is assumed by Analog Devices for its use, nor for any infringements of patents or other rights of third parties that may result from its use. Specifications subject to change without notice. No license is granted by implication or otherwise under any patent or patent rights of Analog Devices. Trademarks and registered trademarks are the property of their respective owners.

For price, delivery, and to place orders: Analog Devices, Inc., One Technology Way, P.O. Box 9106, Norwood, MA 02062-9106 Phone: 781-329-4700 • Order online at [www.analog.com](http://www.analog.com) Application Support: Phone: 1-800-ANALOG-D

**GaAs MMIC I/Q MIXER MODULE  
4.0 - 8.5 GHz**



**Quadrature Channel Data Taken Without IF Hybrid**

**Isolations**

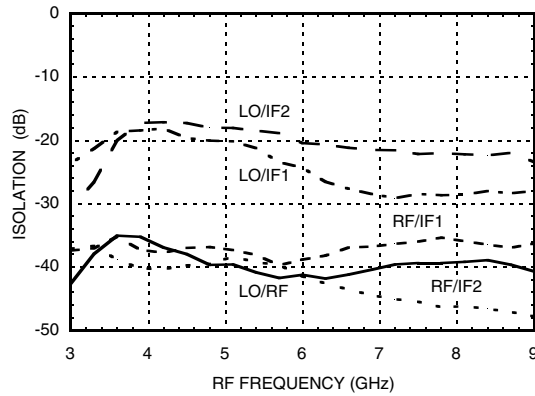

**IF Bandwidth\***

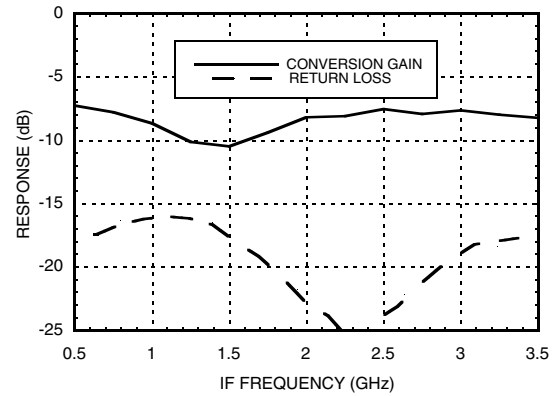

**Amplitude Balance vs. LO Drive**

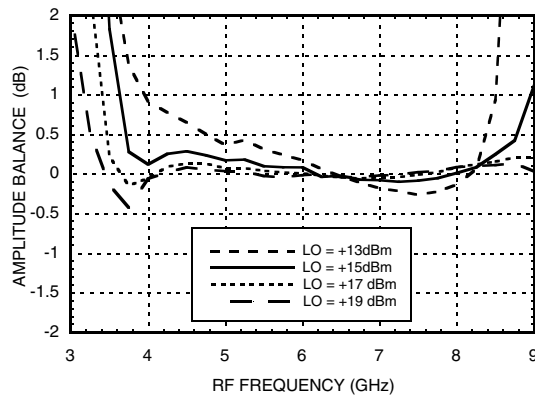

**Phase Balance vs. LO Drive**

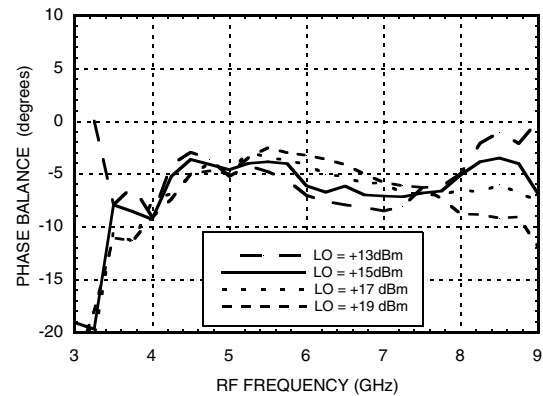

**Upconverter Performance Conversion Gain vs. LO Drive\***

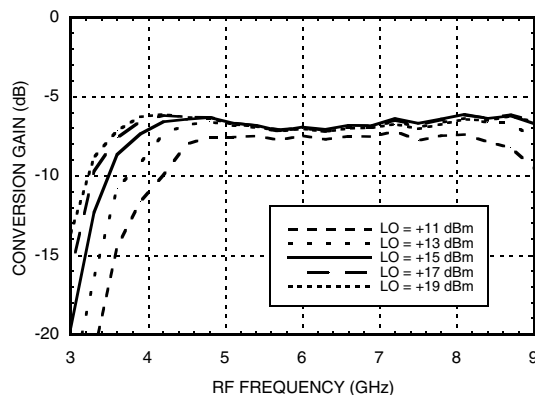

**Upconverter Performance Sideband Rejection vs. LO Drive\***

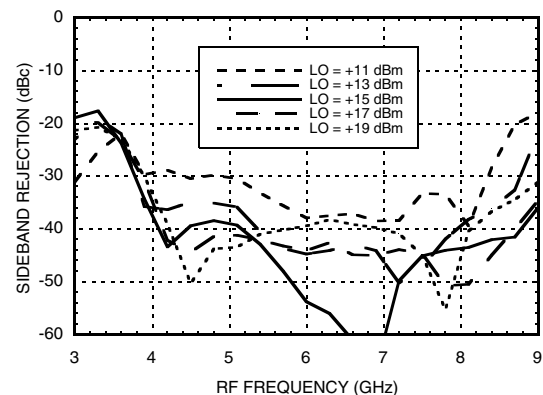

\* Conversion gain data taken with external IF hybrid

Information furnished by Analog Devices is believed to be accurate and reliable. However, no responsibility is assumed by Analog Devices for its use, nor for any infringements of patents or other rights of third parties that may result from its use. Specifications subject to change without notice. No license is granted by implication or otherwise under any patent or patent rights of Analog Devices. Trademarks and registered trademarks are the property of their respective owners.

For price, delivery, and to place orders: Analog Devices, Inc., One Technology Way, P.O. Box 9106, Norwood, MA 02062-9106 Phone: 781-329-4700 • Order online at [www.analog.com](http://www.analog.com) Application Support: Phone: 1-800-ANALOG-D

## GaAs MMIC I/Q MIXER MODULE 4.0 - 8.5 GHz



### Harmonics of LO

LO Freq. (GHz)	nLO Spur at RF Port			
	1	2	3	4
3.5	41	54	59	57
4.5	43	43	59	58
5.5	46	57	52	71
6.5	44	60	71	60
7.5	43	66	69	62
8.5	44	65	69	70

LO = +15 dBm  
Values in dBc below input LO level measured at RF Port.  
Data taken with IF ports terminated in 50 Ohms.

### MxN Spurious Outputs

mRF	nLO				
	0	1	2	3	4
0	xx	-10	35	25	51
1	35	0	45	54	74
2	94	64	72	67	95
3	95	97	99	84	97
4	90	93	95	97	106

RF = 5.6 GHz @ -10 dBm  
LO = 5.5 GHz @ +15 dBm  
Data taken without IF hybrid  
All values in dBc below IF power level

### Absolute Maximum Ratings

RF / IF Input	+20 dBm
LO Drive	+27 dBm
Storage Temperature	-65 to +150 °C
Operating Temperature	-55 to +85 °C



ELECTROSTATIC SENSITIVE DEVICE  
OBSERVE HANDLING PRECAUTIONS

**GaAs MMIC I/Q MIXER MODULE  
4.0 - 8.5 GHz**



**Outline Drawing**

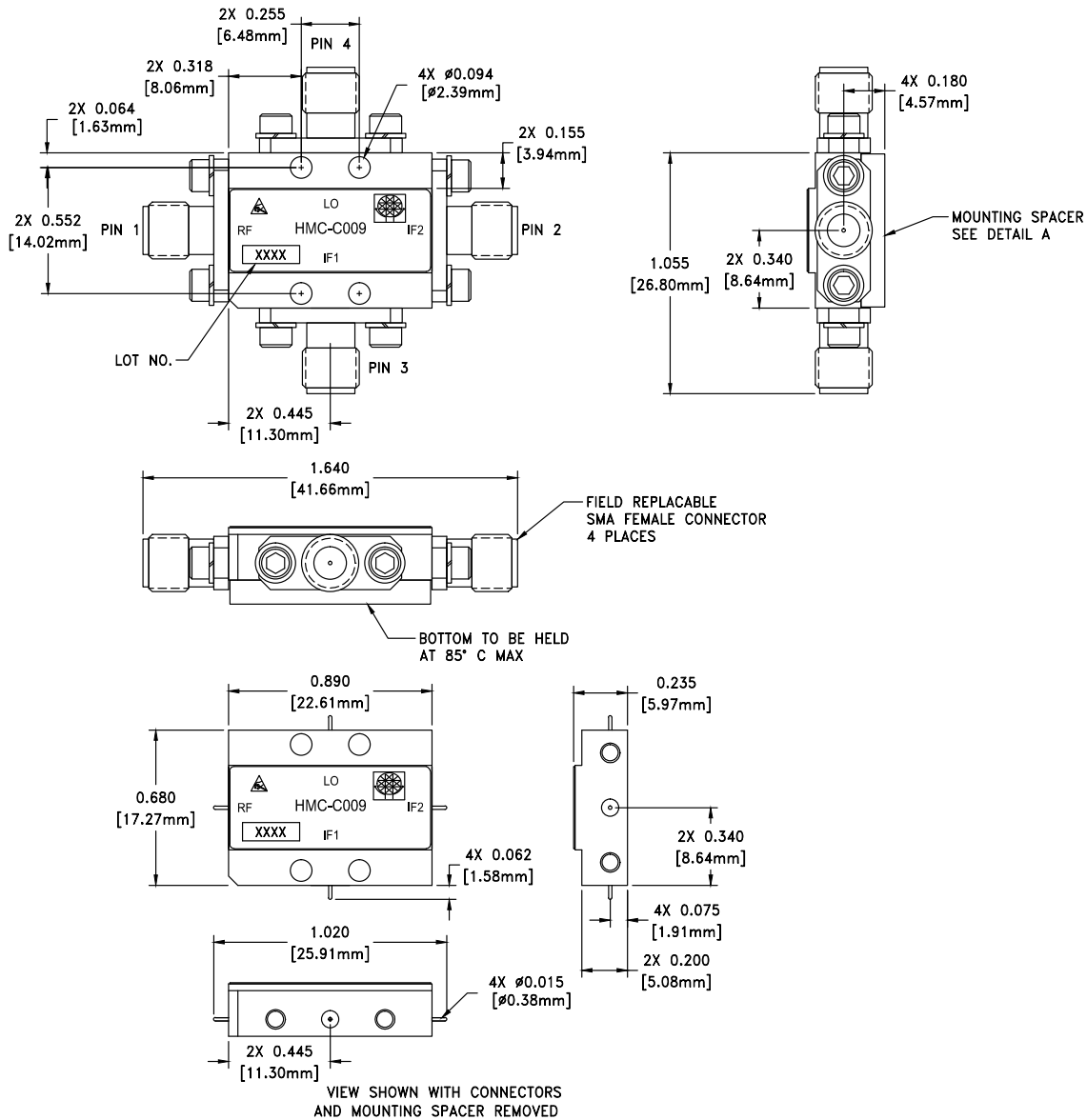

**Package Information**

Package Type	C-4
Package Weight <sup>[1]</sup>	20 gms <sup>[2]</sup>
Spacer Weight	2.6 gms <sup>[2]</sup>

[1] Includes the connectors

[2] ±1 gms Tolerance

**NOTES:**

1. PACKAGE, LEADS, COVER MATERIAL: KOVAR™
2. FINISH: GOLD PLATE OVER NICKEL PLATE
3. MOUNTING SPACER: NICKEL PLATED ALUMINUM
4. ALL DIMENSIONS ARE IN INCHES [MILLIMETERS]
5. TOLERANCES:
  - 5.1 .XX = ±0.02
  - 5.2 .XXX = ±0.010
6. FIELD REPLACEABLE SMA CONNECTORS  
TENSOLITE 5602 - 5CCSF OR EQUIVALENT
7. TO MOUNT MODULE TO SYSTEM PLATFORM REPLACE 0 -80  
HARDWARE WITH DESIRED MOUNTING SCREWS

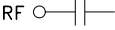
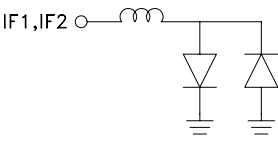

### Pin Descriptions

Pin Number	Function	Description	Interface Schematic
1	RF	This pin is AC coupled and matched to 50 Ohms.	RF 
2	IF1	This pin is DC coupled. For applications not requiring operation to DC, this port should be DC blocked externally using a series capacitor whose value has been chosen to pass the necessary IF frequency range. For operation to DC, this pin must not source/sink more than 3mA of current or part non-function and possible part failure will result.	IF1,IF2 
3	IF2		
4	LO	This pin is AC coupled and matched to 50 Ohms.	LO 